

HINGED

U-Access Covers

FSR

Metal Products Group

Hinged U-Access Covers

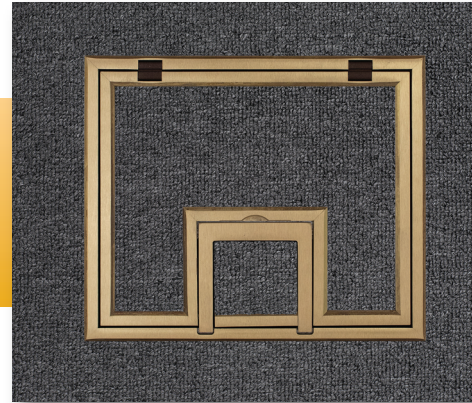
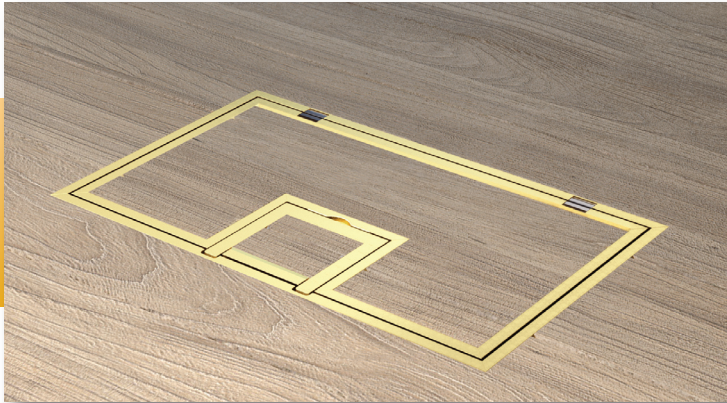

DESCRIPTION

The evolution of our floor box covers over the years has focused on innovative designs, durability, and aesthetics within your floor. Our "Tool-less" U-Access floor box cover features a hinged design for the FL-400, FL-500P, and FL-600P, allowing for smooth entry into our floor boxes. The hinge provides an effortless opening, making replacing equipment a breeze—no more tooling around with hard-to-open floor box covers. The cable access door can also be easily opened by lifting the integrated U-Access handle to access the internal connectors and cables. You won't need tools to open or close the box. We provide 13 different hinged cover options, which include the popular brass and silver carpet or wood edging, to match the designer's requirements. Scrub water approved for carpet, tile, and wood floors.

FEATURES

- "Tool-Less" Hinged Design Large Door
- U-Access Handle For Small Cable Access Door
- 11-gauge steel temporary construction cover included
- 11-gauge finished steel cover with choice of carpet edging
- Mitered brass or aluminum carpet edging .5" or .25" high
- Stainless steel compression latches
- Galvanized Steel

SPECIFICATIONS

- Overall Cover Size:
 - FL-400: 14.88" x 10.69"
 - FL-500P: 10.5" x 12.5"
 - FL-600P: 14" x 12.5"
- Flanging: Height: .25" or .5"
- Material: Brass, Aluminum, Flat, and Solid covers available

See part charts for Max Load Capacities

WHAT'S NEW

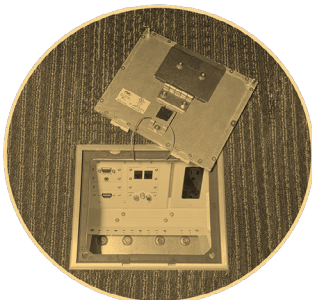

OLD

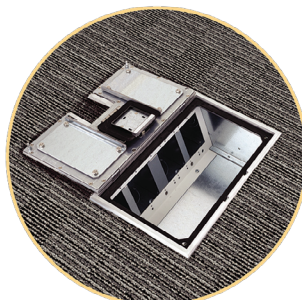

NEW

NO MORE TOOLING AROUND



FSR Inc.

244 Bergen Boulevard, Woodland Park, NJ 07424
Phone: 973.998.2300 · Fax: 973.785.4207
Web: www.fsrinc.com · E-mail: sales@fsrinc.com
Order Desk: 1-800-332-FSR1

LIT1870A

FL-400 Hinged U-Access Floor Box Covers



FL-400-BLP-C



FL-400-BSQ-C



FL-400-B-C

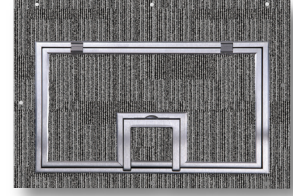

FL-400-SLP-C

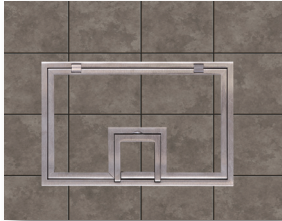

FL-400-SSQ-C

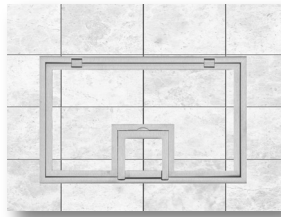

FL-400-S-C



FL-400-PLP-BLK-C

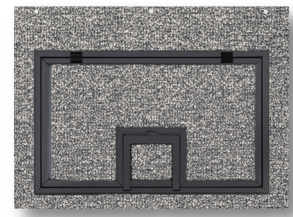

FL-400-PLP-GRY-C

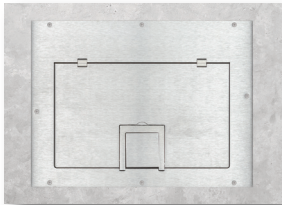

FL-400-SLD-ALU-C

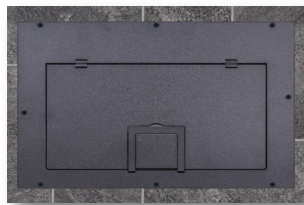

FL-400-SLD-BLK-C

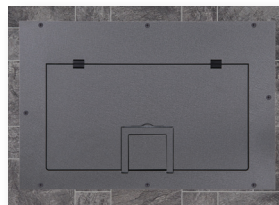

FL-400-SLD-GRY-C

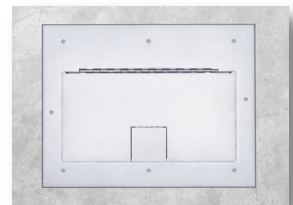

FL-400-PTSLV

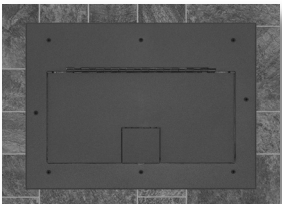

FL-400-PTBK

FL-400 HINGED U-ACCESS COVERS PARTS CHART

Item	Part	Description
18189	FL-400-PTSLV-C	Piano Hinge Flat Silver Painted Smooth Cover (No Flange)
18190	FL-400-PTBK-C	Piano Hinge Flat Black Texture Painted Cover (No Flange)
18191	FL-400-BLP-C	Hinged U-Access Cover with 1/4" Brass Carpet Flange
18192	FL-400-BSQ-C	Hinged U-Access Cover with 1/4" Square Brass Flange
18193	FL-400-B-C	Hinged U-Access Cover with 1/2" Brass Squared Flange
18194	FL-400-SLP-C	Hinged U-Access Cover with 1/4" Aluminum Carpet Flange
18195	FL-400-SSQ-C	Hinged U-Access Cover with 1/4" Square Aluminum Flange
18196	FL-400-S-C	Hinged U-Access Cover with 1/2" Aluminum Squared Flange
18197	FL-400-PLP-BLK-C	Hinged U-Access Cover with 1/4" Painted Carpet Flange - Black
18198	FL-400-PLP-GRY-C	Hinged U-Access Cover with 1/4" Painted Carpet Flange - Gray
18199	FL-400-SLD-ALU-C	Solid Cover with Cable Exit (No Trim) Aluminum
18200	FL-400-SLD-BLK-C	Solid Cover with Cable Exit (No Trim) Black
18201	FL-400-SLD-GRY-C	Solid Cover with Cable Exit (No Trim) Gray
18202	FL-400-CSK	Cover Shim Kit - 1/16" to 1/4" Temp & Finish Cover

*Flat Covers (No Flange) with Piano Hinge (NOT UL Scrub Water Rated)

FL-500P Hinged U-Access Floor Box Covers

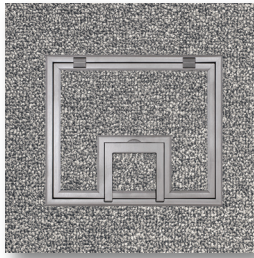

FL-500P-SLP-C

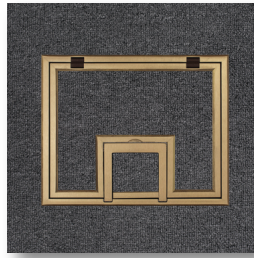

FL-500P-BLP-C



FL-500P-BSQ-C



FL-500P-B-C



FL-500P-SSQ-C



FL-500P-S-C

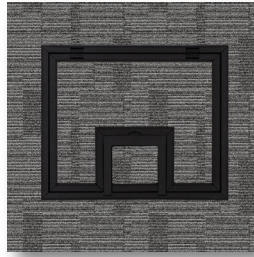

FL-500P-PLP-BLK-C



FL-500P-PLP-GRY-C



FL-500P-BK-C

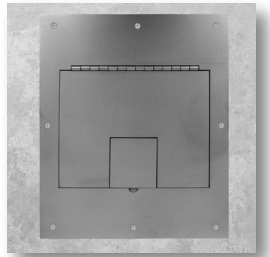

FL-500P-SS-C

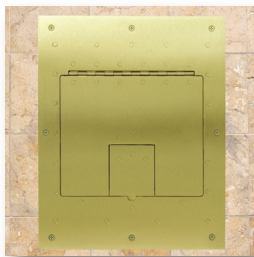

FL-500P-BRS-C

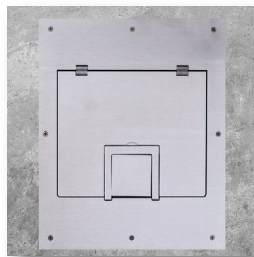

FL-500P-SLD-ALU-C

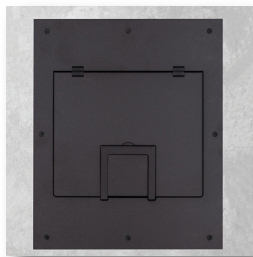

FL-500P-SLD-BLK-C

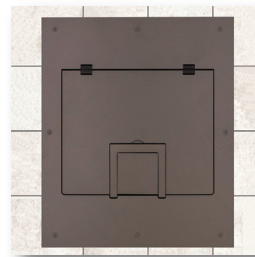

FL-500P-SLD-GRY-C

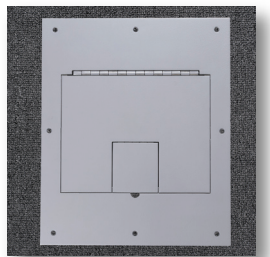

FL-500P-PTSLV

FL-500P HINGED U-ACCESS COVERS PARTS CHART

Item	Part	Description
15075	FL-500P-BLK-C	Piano Hinge Flat Black Wrinkle Powder Coat Cover (No Flange)
15526	FL-500P-SS-C	Piano Hinge Flat Stainless Steel Cover (No Flange)
16221	FL-500P-BRS	Piano Hinge Flat Cover Brass (No Flange)
18153	FL-500P-PTSLV	Piano Hinge Flat Cover Silver Paint (No Flange)
18353	FL-500P-SLP-C	Hinged U-Access Cover with 1/4" Aluminum Carpet Flange *Max static load 1,300 lbs
18442	FL-500P-BLP-C	Hinged U-Access Cover with 1/4" Brass *Max static load 1,300 lb
18443	FL-500P-BSQ-C	Hinged U-Access Cover with 1/4" Brass Flange *Max static load 1,300 lbs
18444	FL-500P-B-C	Hinged U-Access Cover with 1/2" Brass Flange *Max static load 1,500 lbs
18445	FL-500P-SSQ-C	Hinged U-Access Cover with 1/4" Square Aluminum Flange *Max static load 1,300 lbs
18446	FL-500P-S-C	Hinged U-Access Cover with 1/2" Aluminum Flange *Max static load 1,500 lbs
18447	FL-500P-PLP-BLK-C	Hinged U-Access Cover with 1/4" Black Painted Carpet Flange *Max static load 1,300 lbs
18449	FL-500P-PLP-GRY-C	Hinged U-Access Cover with 1/4" Grey Flange *Max static load 1,300 lbs
18450	FL-500P-SLD-ALU-C	Hinged U-Access Aluminum Solid Cover w/ Cable Exit (No Trim) *Max static load 2,500 lbs
18451	FL-500P-SLD-BLK-C	Hinged U-Access Black Solid Cover with Cable Exit (No Trim) *Max static load 2,500 lbs
18453	FL-500P-SLD-GRY-C	Hinged U-Access Gray Solid Cover with Cable Exit (No Trim) *Max static load 2,500 lbs
17805	FL-600P-CSK	Cover Shim Kit 1/16 - 5/16 Temp & Finish Covers

*Flat Covers (No Flange) with Piano Hinge (NOT UL Scrub Water Rated)

FL-600P Hinged U-Access Floor Box Covers

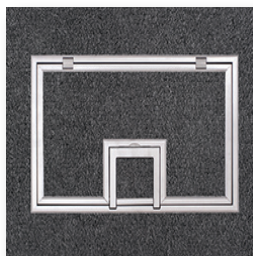

FL-600P-SLP-C



FL-600P-BLP-C



FL-600P-BSQ-C



FL-600P-B-C

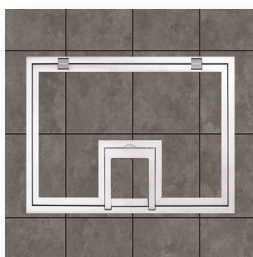

FL-600P-SSQ-C



FL-600P-S-C

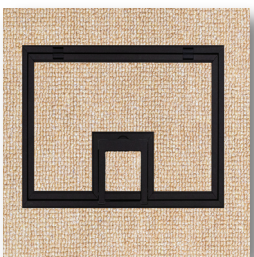

FL-600P-PLP-BLK-C

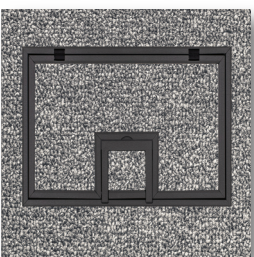

FL-600P-PLP-GRY-C

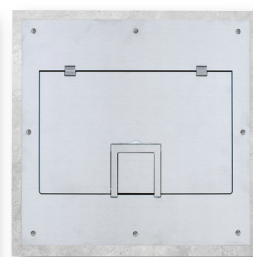

FL-600P-SLD-ALU-C

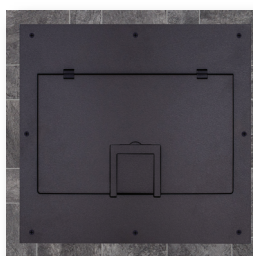

FL-600P-SLD-BLK-C

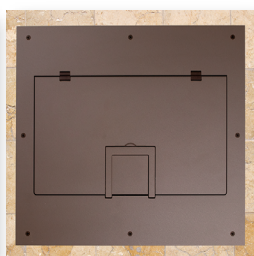

FL-600P-SLD-GRY-C

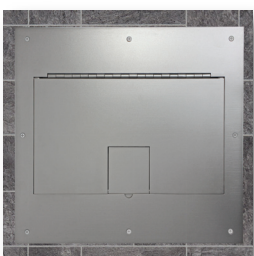

FL-600P-SS-C

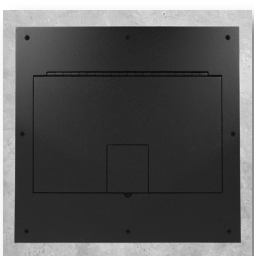

FL-600P-BK-C

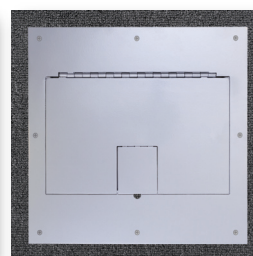

FL-600P-PTSLV

FL-600P HINGED U-ACCESS COVERS PARTS CHART

Item	Part	Description
15472	FL-600P-BK-C	Piano Hinge Flat Black Wrinkle Powder Coat Cover (No Flange)
18155	FL-600P-PTSLV	Piano Hinge Flat Painted Silver Cover (No Flange)
16945	FL-600P-SS-C	Piano Hinge Flat Stainless Steel Cover (No Flange)
18354	FL-600P-SLP-C	Hinged U-Access Floor Box Cover with 1/4" Aluminum Carpet Flange *Max static load 1,200 lbs
18454	FL-600P-BLP-C	Hinged U-Access Floor Box Cover with 1/4" Brass Carpet Flange *Max static load 1,200 lbs
18455	FL-600P-BSQ-C	Hinged U-Access Floor Box Cover with 1/4" Square Brass Flange *Max static load 1,200 lbs
18456	FL-600P-B-C	Hinged U-Access Floor Box Cover with 1/2" Brass Squared Flange *Max static load 1,500 lbs
18457	FL-600P-SSQ-C	Hinged U-Access Floor Box Cover with 1/4" Square Aluminum Flange *Max static load 1,200 lbs
18458	FL-600P-S-C	Hinged U-Access Floor Box Cover with 1/2" Aluminum Carpet Flange *Max static load 1,500 lbs
18459	FL-600P-PLP-BLK-C	Hinged U-Access Floor Box Cover with 1/4" Black Painted Carpet Flange *Max static load 1,200 lbs
18461	FL-600P-PLP-GRY-C	Hinged U-Access Floor Box Cover with 1/4" Black Painted Carpet Flange *Max static load 1,200 lbs
18462	FL-600P-SLD-ALU-C	Hinged U-Access Floor Box Solid Aluminum Cover with Cable Exit (No Trim) *Max static load 2,600 lbs
18463	FL-600P-SLD-BLK-C	Hinged U-Access Floor Box Solid Black Cover with Cable Exit (No Trim) *Max static load 2,600 lbs
18465	FL-600P-SLD-GRY-C	Hinged U-Access Floor Box Solid Gray Cover with Cable Exit (No Trim) *Max static load 2,600 lbs
17805	FL-600P-CSK	Cover Shim Kit 1/16 - 5/16 Temp & Finish Covers

FL-500P COVER DETAIL DRAWINGS

STYLE 1

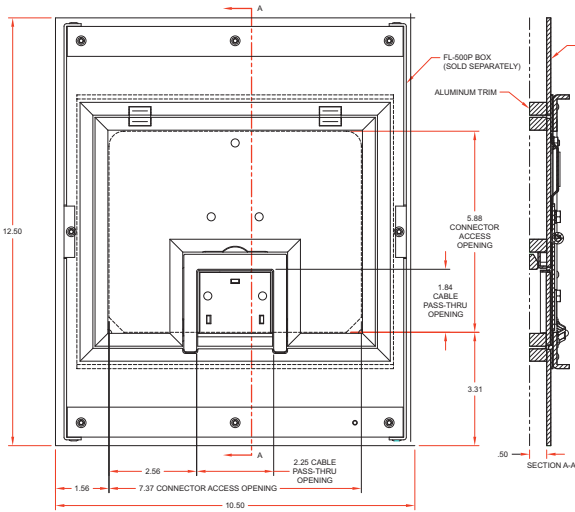

STYLE 2

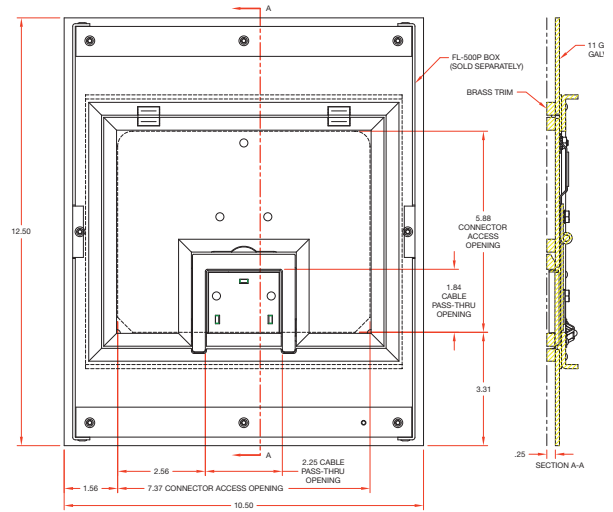

STYLE 3

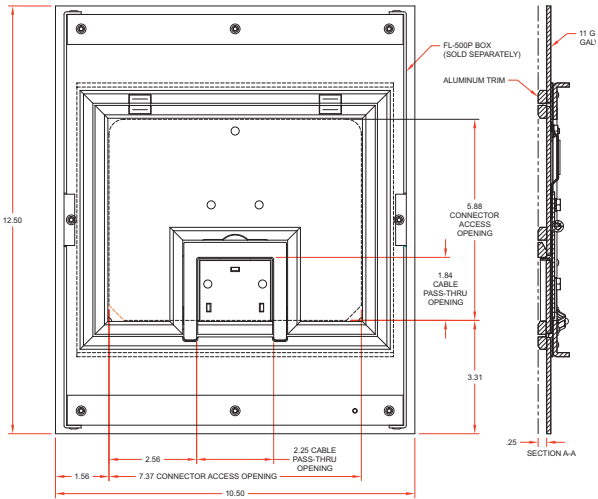

STYLE 4

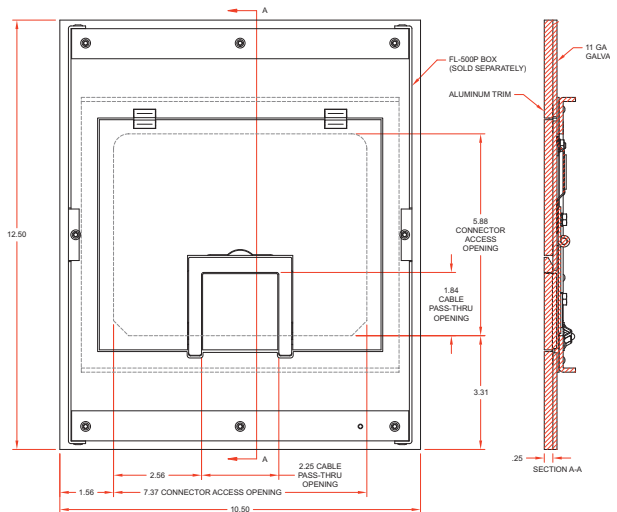

STYLE 5

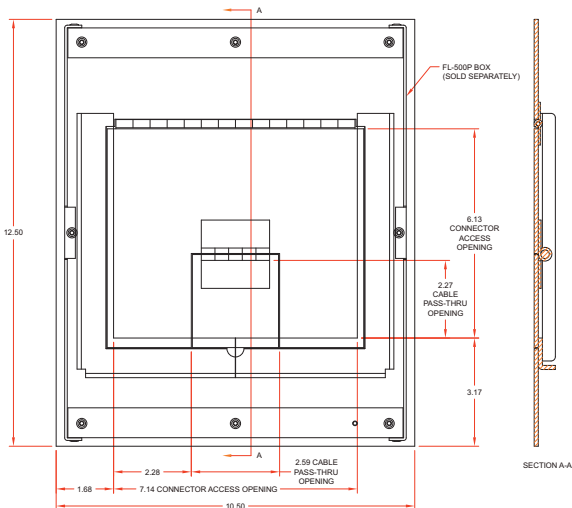

STYLE	DESCRIPTION
1	1/2" SQUARED FLANGE FOR CARPET OR TILE
2	1/4" SQUARED FLANGE FOR CARPET OR TILE
3	1/4" BEVELED FLANGE FOR CARPET
4	SOLID COVER, NO FLANGE**
5	SOLID COVER, NO FLANGE, PIANO HINGED

Additional Flange heights and colors are available. Consult factory.

**Note: Cover Shim Kit (FL-500-CSK) may be required to set the height of box "Pre-Pour" so the top of Finish Cover matches top of finished floor.

FL-600P COVER DETAIL DRAWINGS

STYLE 1

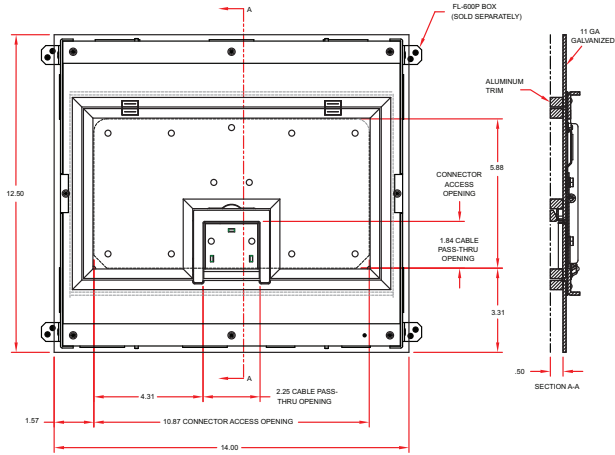

STYLE 2

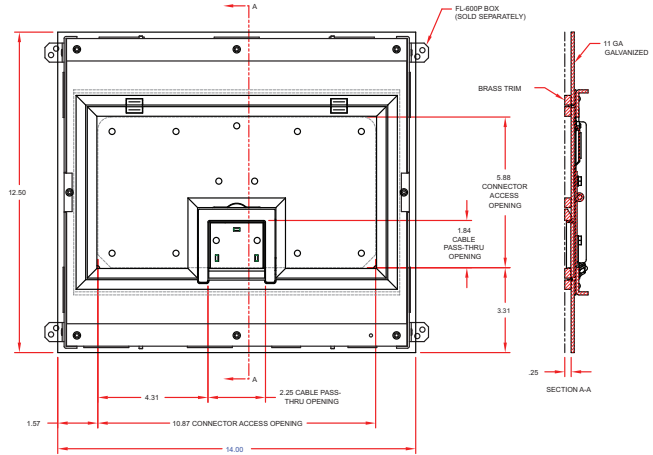

STYLE 3

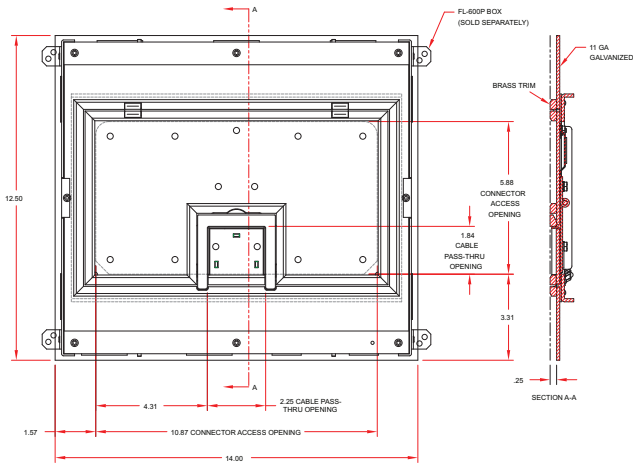

STYLE 4

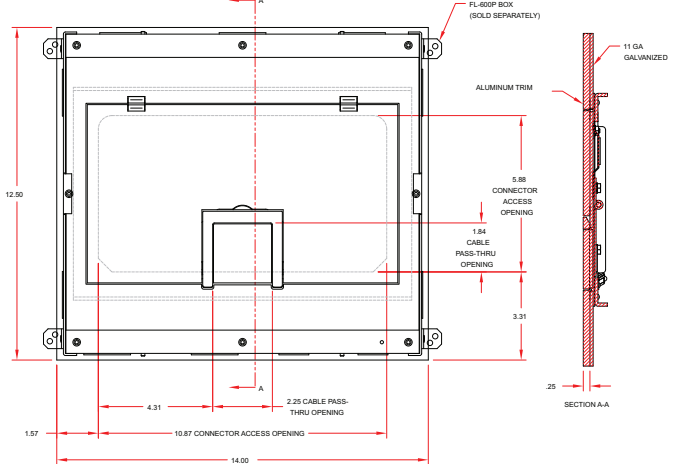

STYLE 5

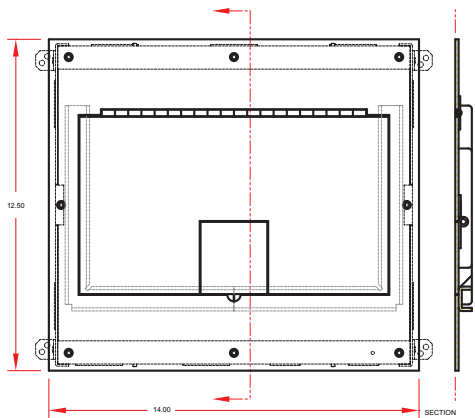

STYLE	DESCRIPTION
1	1/2" SQUARED FLANGE FOR CARPET OR TILE
2	1/4" SQUARED FLANGE FOR CARPET OR TILE
3	1/4" BEVELED FLANGE FOR CARPET
4	SOLID COVER, NO FLANGE**
5	SOLID COVER, NO FLANGE, HINGED**

Additional Flange heights and colors are available. Consult factory.

**Note: Cover Shim Kit (FL-600-CSK) may be required to set the height of box "Pre-Pour" so the top of Finish Cover matches top of finished floor.



Specifications are subject to change without notice.

FSR

244 Bergen Boulevard, Woodland Park, NJ 07424

Phone: 973.998.2300 · Fax: 973.785.4207

Web: www.fsrinc.com · E-mail: sales@fsrinc.com