

## GANG DIVIDER ASSEMBLY

DIVIDER HOLDER **MUST** BE ORIENTED AS SHOWN WHEN ATTACHING TO DIVIDERS, IN ORDER TO PROPERLY ASSEMBLE BOX INTERIOR.

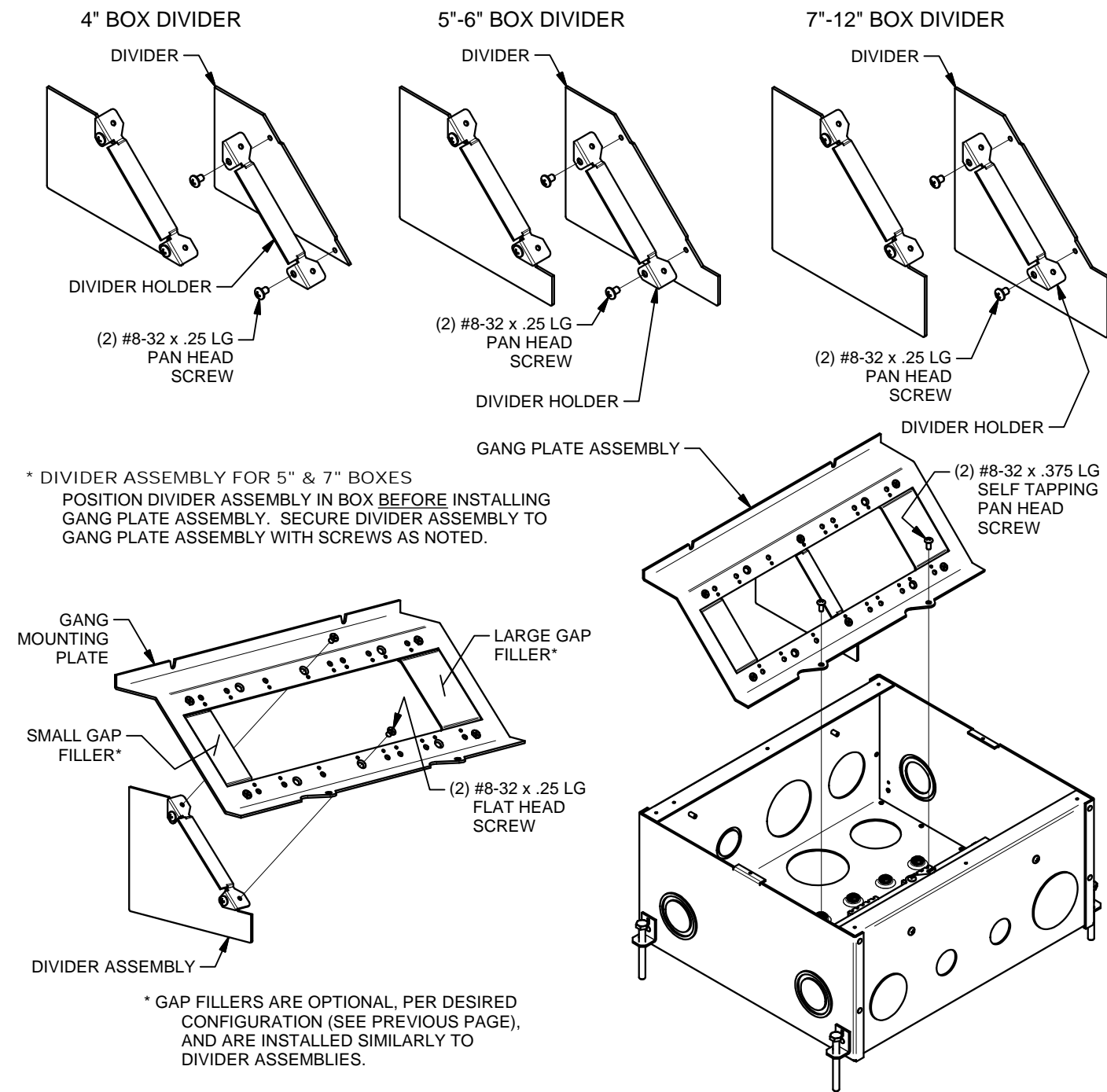

\* DIVIDER ASSEMBLY FOR 5" & 7" BOXES  
POSITION DIVIDER ASSEMBLY IN BOX BEFORE INSTALLING GANG PLATE ASSEMBLY. SECURE DIVIDER ASSEMBLY TO GANG PLATE ASSEMBLY WITH SCREWS AS NOTED.

\* GAP FILLERS ARE OPTIONAL, PER DESIRED CONFIGURATION (SEE PREVIOUS PAGE), AND ARE INSTALLED SIMILARLY TO DIVIDER ASSEMBLIES.

## INSTALLING ELECTRONIC COMPONENTS

PULL WIRES AND CABLES TO BOX AS NECESSARY (REMOVAL OF GANG MOUNTING BRACKETS MAY BE REQUIRED). TERMINATE WIRES AND CABLES TO ELECTRONIC COMPONENTS, AND INSTALL ELECTRONIC COMPONENTS ONTO GANG MOUNTING BRACKETS. REINSTALL TEMPORARY COVER IF FINISHED COVER IS TO BE INSTALLED AT A LATER DATE.

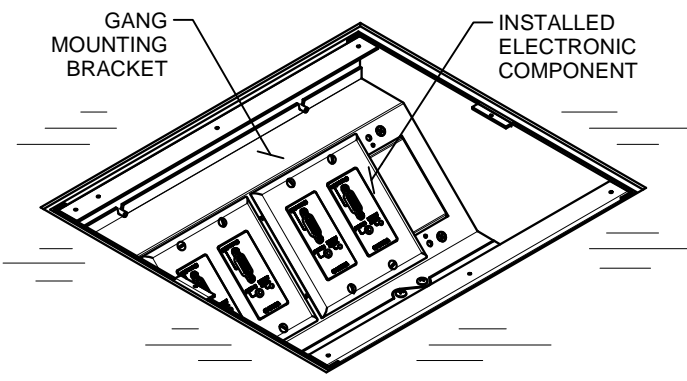

## BOX INSTALLATION - STEP 1

LOCATE AND POSITION BOX IN ACCORDANCE WITH FLOOR PLANS. TOP SURFACE OF TEMPORARY COVER MUST BE SET TO MATCH THE HEIGHT OF THE FINISHED FLOOR - ie STONE, WOOD OR CONCRETE - SEE TYPICAL INSTALLATION HEIGHTS. LEVEL AND ANCHOR BOX AS REQUIRED. USE SCREWS, NAILS, OR WIRE TO PREVENT BOX FROM FLOATING DURING POUR. REMOVE AND RETAIN TEMPORARY COVER AND SCREWS. ROUTE CONDUITS TO BOX AS REQUIRED. **GANG BRACKET SCREWS MUST BE IN PLACE AND BOTTOMED TO ENSURE SCREW VOIDS AFTER POUR.** PLACE THIS INSTALLATION GUIDE BACK INTO BOX, ALONG WITH ALL SUPPLIED ITEMS, AND REINSTALL TEMPORARY COVER.

## BOX INSTALLATION - STEP 2

SCREED TO TOP OF BOX SURFACE FOR 3/16" THICK CARPET/FLOORING OR SPECIFIC HEIGHT TO ALLOW FOR THICKER FINISHED FLOOR MATERIAL. HAND TROWELING RECOMMENDED NEAR BOX EDGES. BOX HAS NO HEIGHT ADJUSTMENT AFTER CONCRETE POUR.

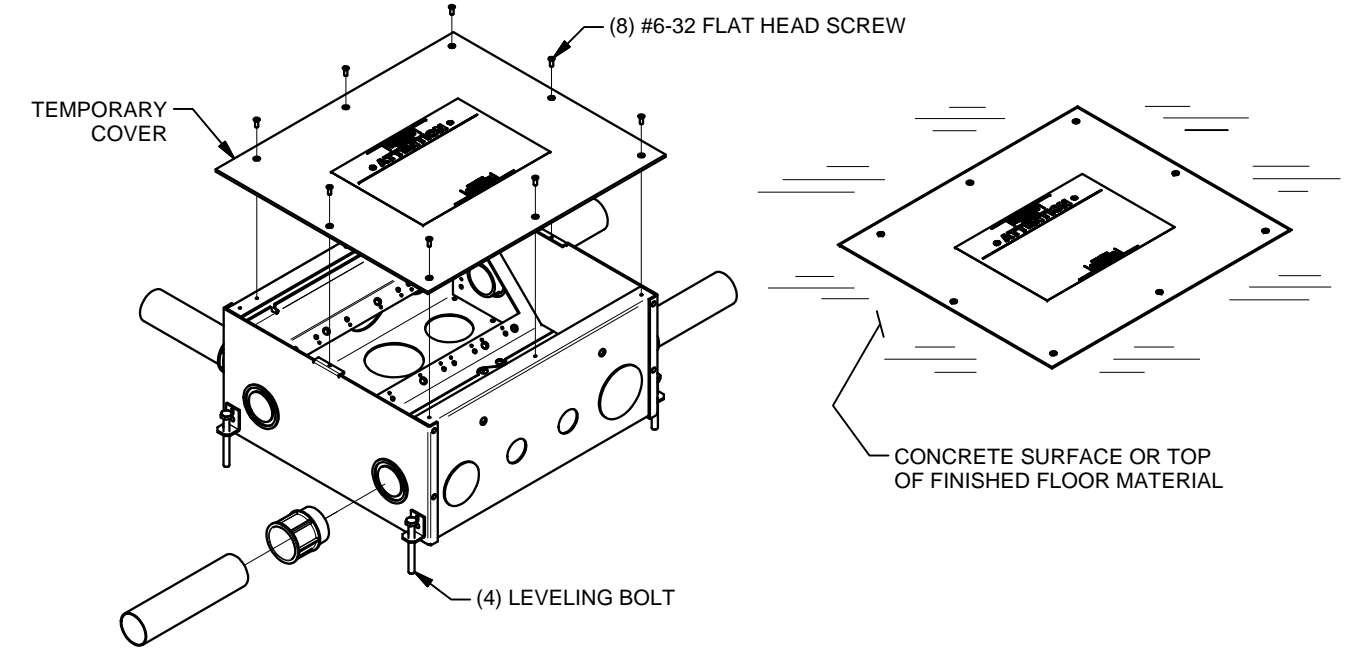

**TYPICAL INSTALLATION HEIGHTS** FLOOR BOX TEMPORARY COVER WILL EITHER BE INSTALLED DIRECTLY ON THE BOX OR SHIMMED BASED ON THE COVER AND FLOORING SPECIFICATIONS. SHIM KITS SOLD SEPARATELY (FL-600P-CSK). THE TEMPORARY COVER MAY NOT BE FLUSH WITH THE FINISH FLOOR IN ALL INSTALLATIONS.

### Carpeted or Tile Floors, Cover types - BLP, BSQ, B, SLP, SSQ, S

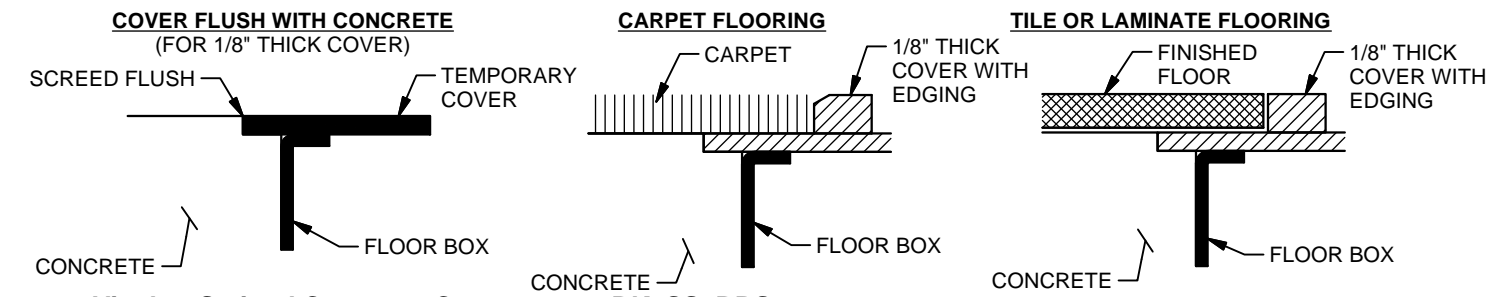

### Vinyl or Stained Concrete, Cover types - BK, SS, BRS

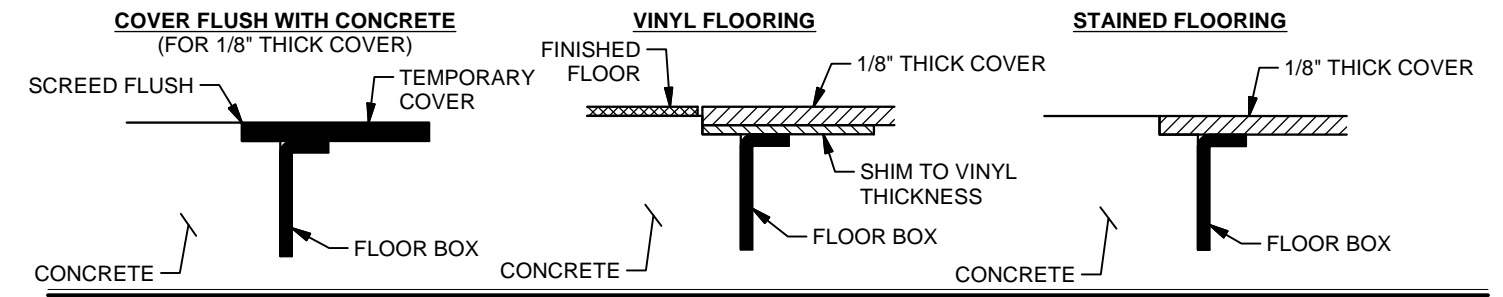

**TYPICAL INSTALLATION HEIGHTS**

FLOOR BOX TEMPORARY COVER WILL EITHER BE INSTALLED DIRECTLY ON THE BOX OR SHIMMED BASED ON THE COVER AND FLOORING SPECIFICATIONS. SHIM KITS SOLD SEPARATELY (FL-600P-CSK). THE TEMPORARY COVER MAY NOT BE FLUSH WITH THE FINISH FLOOR IN ALL INSTALLATIONS.

**Vinyl or Stained Concrete, Cover types - SLD-ALM, SLD-Color**

**COVER FLUSH WITH CONCRETE**  
(FOR 3/8" THICK COVER)

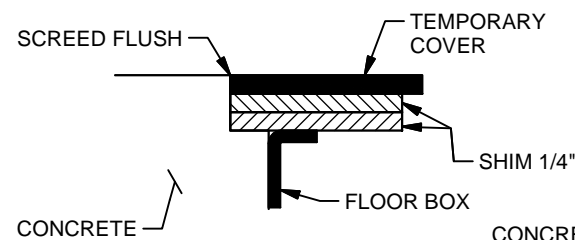

**VINYL FLOORING**

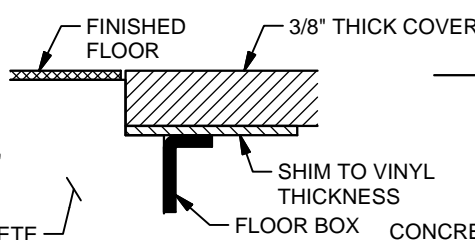

**STAINED FLOORING**

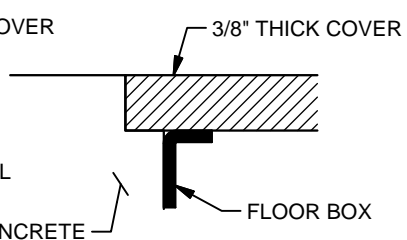

**Wood / Floating Wood, Cover types - BK, SS, BRS (1/8"), SLD-ALM, SLD-Color (3/8")**

**COVER ABOVE CONCRETE**  
(FOR COVER WITHOUT EDGING)

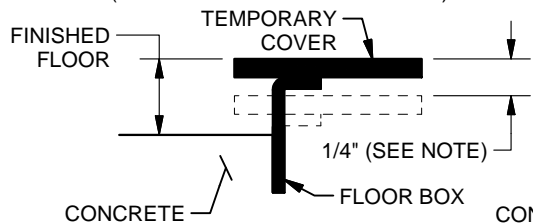

**WOOD FLOORING**

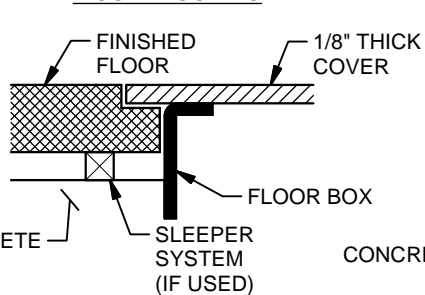

**WOOD FLOORING**

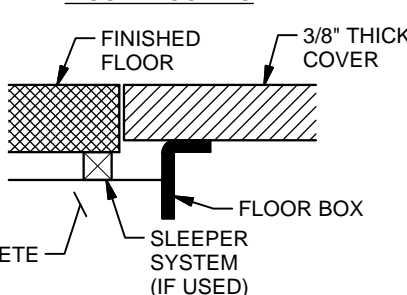

NOTE: FOR 3/8" THICK COVER LOWER TEMPORARY COVER AN ADDITIONAL 1/4" FROM FINISHED FLOOR DIMENSION OR USE SHIM KIT

**Wood / Floating Wood, Cover types - BLP, BSQ, B, SLP, SSQ, S**

**COVER ABOVE CONCRETE**  
(FOR COVER WITH EDGING)

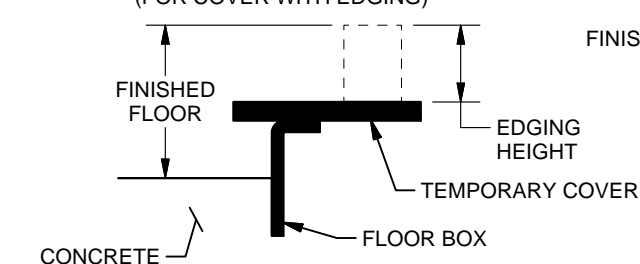

**WOOD FLOORING**

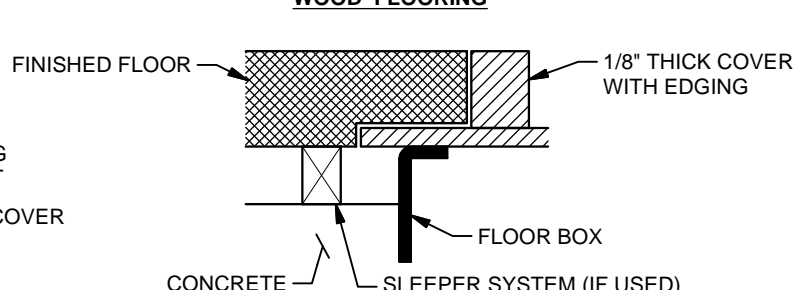

**CENTER DIVIDER CONFIGURATION (NOT APPLICABLE ON 4" BOX)**

SET ASIDE TEMPORARY COVER AND SCREWS FOR POSSIBLE RE-INSTALLATION. REMOVE AND RETAIN GANG MOUNTING BRACKETS AND SCREWS TO CONFIGURE CENTER DIVIDERS.

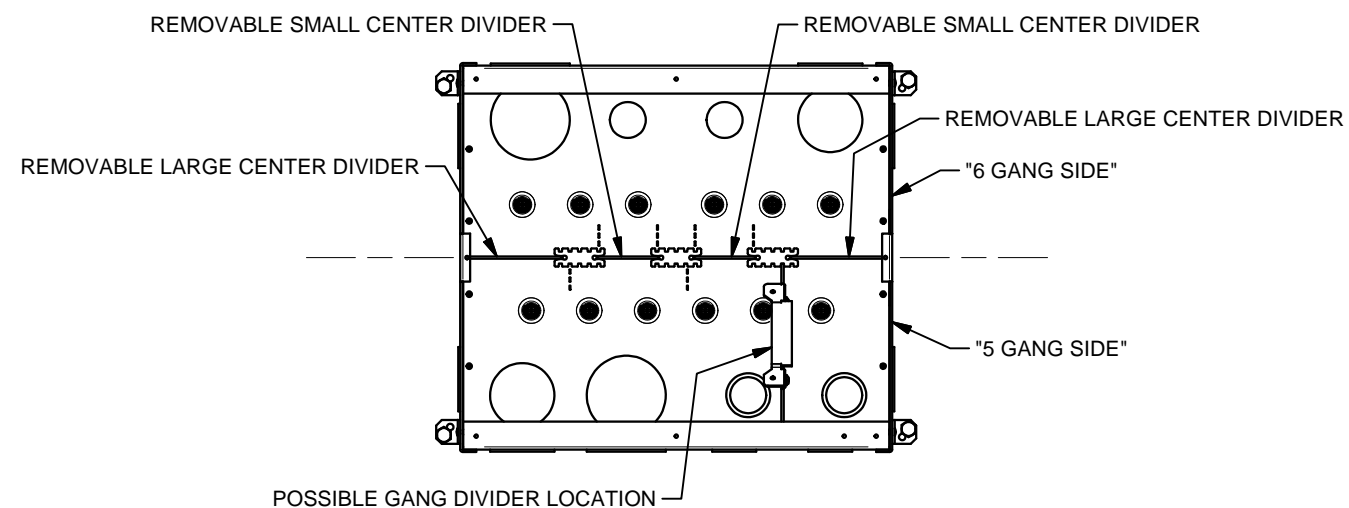

**GANG MOUNTING BRACKET CONFIGURATION**

PER CUSTOMER SPECIFICATIONS, CONFIGURE GANG MOUNTING BRACKETS AS SHOWN BELOW AND REASSEMBLE INTO BOX.

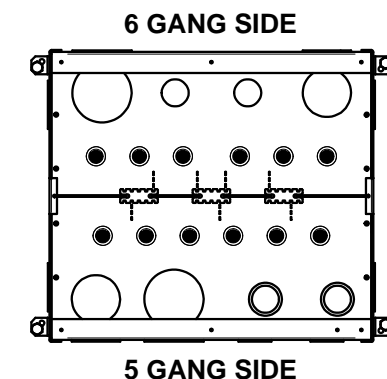
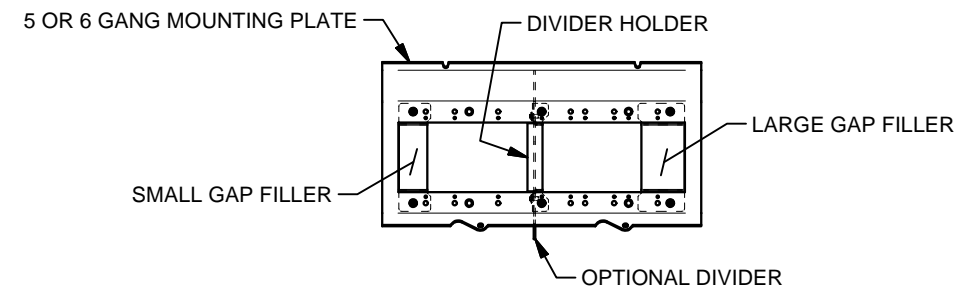

**"5 GANG SIDE" MOUNTING BRACKET CONFIGURATIONS**

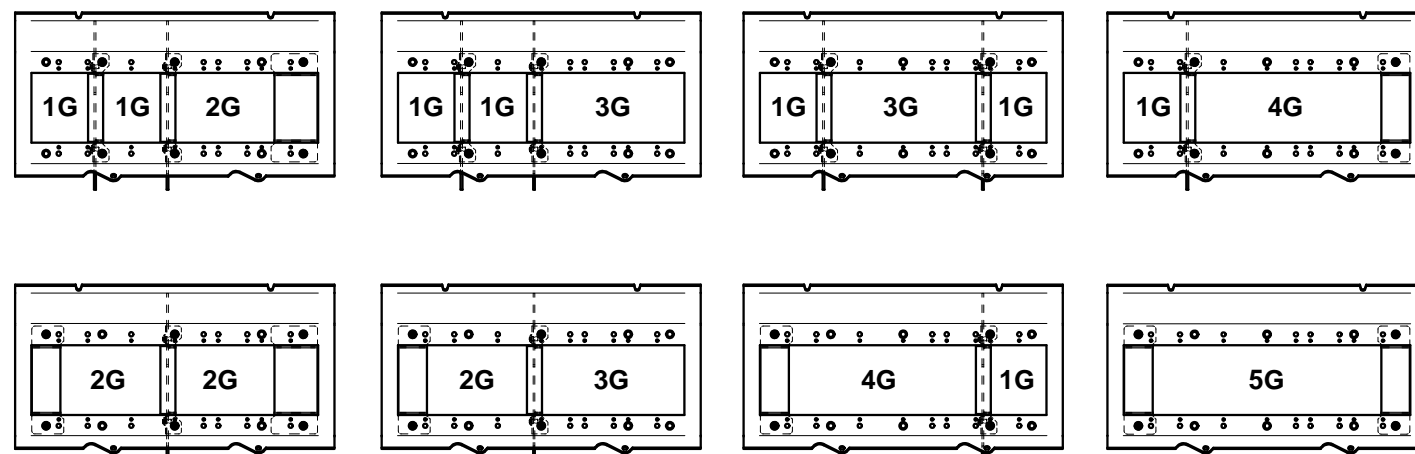

**"6 GANG SIDE" MOUNTING BRACKET CONFIGURATIONS**

