



# AV420R RETAIL Price List

EFFECTIVE APRIL 6, 2020

Viewing Surface Families . . . . .	3	Rigid Rear Projection Screens. . . . .	82
Electric Projection Screens . . . . .	8	AV Mounts & Structures . . . . .	86
Manual Projection Screens . . . . .	37	Projector & VC Camera Lifts/Cages . . . .	90
Fixed Projection Screens. . . . .	47	Video Conferencing Backgrounds . . . . .	99
Portable Projection Screens . . . . .	61	Terms and Conditions . . . . .	109

ELECTRIC  
SCREENS

MANUAL  
SCREENS

FIXED  
SCREENS

PORTABLE  
SCREENS

REAR  
SCREENS

AV MOUNTS &  
STRUCTURES

PROJECTOR &  
CAMERA LIFTS

VIDEO CONFERENCING  
BACKGROUNDS



### Sign up for the Draper Pro Portal!

Download your current pricing, check order status, track your shipments and access some of the best tools in the industry, like the Draper Projection Planner. Go to [draperinc.com/draperpro](http://draperinc.com/draperpro)

MAP Policy: See page 110.

## WE CAN DELIVER!

Draper average lead times are consistently 6 days or less,

**Our commitment to you: Keep it that way.**

*Some product and volume restrictions apply.*

## Icon Ace Freestand

**Creates a stable and reliable freestanding modular video wall**

Minimal components make this stylish unit easy to assemble. Fine X/Y/Z axis adjustment capabilities provide precise display alignment in all four corners. Height and width can be adjusted with millimeter precision for edge-to-edge mounting. This modular system allows multiple Icon Ace Freestands to be mounted side-by-side to create an extra-long video wall. See page 87.

## 5 New Video Wall Mount Models

**Different mounting options for whatever wall style you need**

Video Wall Mounts provide a simple, cost-effective way of building a video wall of any dimension and shape with the aid of mounts designed to make exact alignment of each unit easy. Pages 87-88.

## Draper Mount Interface for Barco UniSee

**Simple-to-install wall-mounting solution**

The built-in precision alignment feature provides precise location of the Barco UniSee wall crosses, eliminating the need for additional wall-mounting hardware or substrates. So simple to use and lightweight—the mount interface can be installed by one person reducing on site installation costs. The configurable design will accommodate any Barco UniSee video wall array size, plus, when combined with the Draper® SmartTrim for UniSee trim kit, the solution is ideal for any Barco UniSee installation. See page 96.

## Draper Pro App

**Exclusively for Draper dealers**

Download the Draper Pro app and get your order status and much more right at your fingertips. Now available on Android, iOS, Windows, and Mac.

- Check your order status and track your shipments
- Keep up to date with the latest product information
- Get technical documents
- Find Draper contact information

**Getting started is easy!**



## Online Payments

**Logging in has its advantages!**

When you log in to the Draper Pro Portal you can pay multiple sales orders or invoices and make partial payments on invoices. You can see a list of open invoices and a history of payments, and also view credit and debit memos. Registration is free!

Your personal information goes straight to the bank. Draper never saves your personal information.

## Ordering from this Price List

This price list contains part numbers for most products. The part numbers represent the most popular standard features. If you order options listed in the "Options" paragraph for each product, such as a non-standard case color, extra drop, or built-in controls, you will see a product description rather than a part number on your acknowledgment, packing list, or invoice. If you order a standard product with no variation, our paperwork will show the part number followed by a short description. If you do not see a part number for the product you would like to order, please call or email.

## Dimensional Weights

Small-package services, such as UPS, ship most packages by actual weight. However, when a package is unusually large or bulky for its weight, a weight factor is calculated based on the dimensions of the carton. Certain Draper products are charged for dimensional weight when shipped via parcel service. In order to help you estimate your shipping costs more accurately, we've provided dimensional weights wherever available in this price list. Wherever there is no dimensional weight, you may use the shipping weight for your freight calculation.

Some air freight shipments may also ship under a dimensional weight. Contact Draper for a freight estimate or try online with our Dealer Portal.

## Core, Advanced, and Tailored

Draper has the capability and capacity to produce core, advanced and tailored solutions – in short, we can deliver you a solution that matches your unique needs, from the simplest of jobs to the most complex challenges. Our core product offerings are easy to order and deliver quickly on a short turnaround time. Our Advanced solutions take those core concepts a step further, offering with more options that help your solution adapt to more your specific needs. Tailored solutions offer the most flexibility for complex installations, allowing us to partner with you to find your perfect fit.

## Additional Information

Viewing Surface Families . . . . .	3
Viewing Surface Descriptions . . . . .	4-6
Recycling Your AV Equipment . . . . .	5
Screen Size Selection . . . . .	7
Communicating with Draper . . . . .	107
Part Number Prefix Key . . . . .	109
Terms and Conditions . . . . .	109
Patent Information . . . . .	109
MAP Policy . . . . .	110
Freight Considerations. . . . .	119
Alphabetical Index. . . . .	112

## Discontinued Products

As we reviewed our product line this year, looking to the future, we found that some products are no longer needed in our line. We're saying farewell to a few old friends. In general, we have already established functional replacements for these in our product offering. If you have any questions about the products to recommend in place of these, please contact your Draper salesperson at 1.800.238.7999.

- Access MultiView E and V Screens
- Ambassador Projection Screens
- Artisan E, V and M
- Envoy Electric Projection Screens
- Evenroll Rope and Pulley Screens
- RoadWarrior Portable Screens
- Screen Boom
- Locking VC Camera Box
- Orbiter Projector Lift
- Phantom Projector Lift
- We have also discontinued the smallest sizes of many of our projection screen models.

# Viewing Surface Families and Names

Draper offers the widest selection of viewing surfaces in the industry, giving you the flexibility to choose the right surface for ANY installation.

With such a wide selection, choosing the right surface can seem like a challenge. To make it simple, we have grouped our surfaces into five families. In addition, each surface has been given a unique and descriptive name with numeric parameters to help anyone understand their qualities and purpose at a glance.

Having trouble choosing the right screen? Visit our website and check out our Screen Selection Tools. There you will find multiple tools that will aid you in making the best decision. [draperinc.com/projectionscreens](http://draperinc.com/projectionscreens)

## Families of Viewing Surfaces

Draper viewing surfaces are divided into five distinct families: *OptiView*, *OptiFlex*, *CineFlex*, *ClearSound*, and *TecVision*®.

**4K READY!** **OptiView:** Our OptiView surfaces are self-supporting and do not require tensioning to perform properly. These surfaces are generally installed on operable roller screens with a dowel. Most surfaces in this group have a tearproof fiberglass base textile. OptiView surfaces are extremely sturdy and suitable for use in a variety of settings.

**4K READY!** **OptiFlex:** OptiFlex surfaces are suitable for tensioning and are available on permanently tensioned screens, tab tensioned roller-operated screens, and portable screens.

**4K READY!** **CineFlex:** The CineFlex family offers choices of gain and color to meet a range of rear and dual front/rear projection needs. CineFlex surfaces are available on a wide range of permanently tensioned, portable, and tab tensioned projection screen models.

**4K READY!** **ClearSound:** All surfaces in the ClearSound family are acoustically transparent. Standard and microscopic perforations are available, and the innovative woven acoustically transparent fabrics—first available through Draper—are also still in the line. The combination of self-supporting and tensioned surfaces means that almost any Draper projection screen model can be provided with a ClearSound surface.

**8K READY!** **TecVision®:** TecVision® surfaces are 8K ready, ISF Certified, and suitable for tensioning and are available on many fixed screens or tab-tensioned roller-operated screens. Choose TecVision® for unmatched consistency of uniformity, gain, contrast, ambient light rejection, and gloss. Please call Draper for additional details.

## Finding Your Surface: Cracking the Code

Now that you've found the right family, the viewing surface name helps you complete your selection. The name consists of a short descriptive phrase followed by an alphanumeric code which tells you about the viewing cone, contrast, gain, and family.

For example, our standard self-supporting Matt White surface is named Matt White XT1000E, and is part of the OptiView family of viewing surfaces. Here is a breakdown of that name.

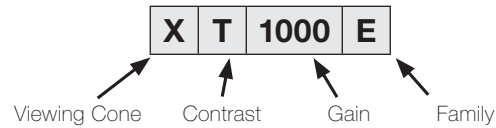

### Viewing Cone

**X:** Extra-wide. Half gain is greater than 60 degrees.

**M:** Moderate. Half gain is 30-60 degrees.

**C:** Controlled. Half gain is less than 30 degrees.

### Contrast

**T:** Typical. Surfaces with "typical" contrast are white in color and are generally recommended for use where ambient light is controlled.

**H:** High. Surfaces with "high" contrast usually have a gray surface or substrate. Their black retention is enhanced and they perform well under reasonable levels of ambient light.

**S:** Superior. This designation is reserved for surfaces with remarkable contrast and resistance to ambient light. Our "Superior" surfaces will meet or exceed the contrast offered by any competitive viewing surface.

### Gain

The numeric portion of the surface name is its typical peak gain x 1000. Gain levels of Draper surfaces cover the full range from 0.6 to 1.9. Lower gain surfaces offer excellent uniformity across wide viewing cones, for excellent edge blending and consistent reproduction with short throw projectors. Higher gain surfaces can grab the viewer with brilliant images in a variety of settings.

### Family

Surface names also include a suffix of **X**, **V**, or **E**.

**V:** Indicates the surface is flexible or suitable for tensioning (including OptiFlex, CineFlex, and some ClearSound surfaces).

**X:** Indicates the surface is from the TecVision® family.

**E:** Indicates the surface is a self-supporting material (including OptiView and some ClearSound surfaces).

## Are you a Draper PRO?

Did you miss the last new price list or an important product announcement. Do you want to track your order? Sign up for the Draper Pro Portal, where you can quickly find everything you need! Sign up using your Draper account number and you can instantly download your current pricing, check order status, track your shipments, and use tools like the Draper Projection Planner. Be sure to leave the "accept emails" box checked so we can send you pricing and product updates. Here are some of the tools we make available in the Pro Portal:

**Price list download**  
**Order status**  
**Shipment tracking**  
**Freight quotations**  
**Projection Planner**

**Inventory level**  
**Projector Lift Selector**  
**FocalPoint configuration**  
**StageScreen configurator**  
**High res photo library**

**Register here:** [www.draperinc.com/DraperPro](http://www.draperinc.com/DraperPro)

# Viewing Surface Descriptions

## OptiView Family of Surfaces

For self-supporting screens



Self-supporting and do not require tensioning to lay flat. These front projection surfaces are generally installed on operable roller screens with a dowel. Most surfaces in this group have a tearproof fiberglass base textile. OptiView surfaces are extremely sturdy and suitable for use in a variety of settings. All viewing surfaces in this family are compatible with 4K and UHD projectors.

### Matt White XT1000E

#### Extra Wide Viewing Cone / Typical Contrast / On-Axis Gain of 1.0

The standard to which all other screen surfaces are compared. Preferred viewing surface in educational and commercial markets. A matt white surface diffuses projected light in all directions, so the image can be seen from any angle. Offers accurate color rendition, and superior clarity due to its smooth, non-embossed surface. Requires adequate provision for the control of ambient light in the audience area. Unity gain with a panoramic 180° cone. Flame and mildew resistant.

This surface is GREENGUARD GOLD certified.

### Contrast Grey XH800E

#### Extra Wide Viewing Cone / High Contrast / On-Axis Gain of 0.8

Smooth grey surface offers excellent resolution and enhances color contrast and black levels in the projected image. Recommended for use with moderate and high output digital projectors. Performs well in conditions of ambient light. Full 180° viewing cone. This surface was previously named "High Contrast Grey." Flame and mildew resistant.

This surface is GREENGUARD GOLD certified.

### Contrast White XH1100E

#### Extra Wide Viewing Cone / High Contrast / On-Axis Gain of 1.1

Diffused white coating over a grey base material, yields a surface with the best qualities of both matt white and contrast grey screen fabrics. Recommended for use with low to moderate light output digital projectors, where some provision for light control exists. Improves the quality of blacks without affecting whites. Flame and mildew resistant.

### Argent White XH1500E

#### Extra Wide Viewing Cone / High Contrast / On-Axis Gain of 1.5

Matt white base material with luminous coating. Offers high reflectivity, while maintaining a broad viewing cone. Provides excellent resolution and color balance. Consider for use with moderate light output projectors in situations where ambient light cannot be adequately controlled. Flame and mildew resistant.

### Pearl White CH1900E

#### Controlled Viewing Cone / High Contrast / On-Axis Gain of 1.9

Matt white surface with pearlescent surface coating. Offers excellent resolution, color balance and uniformity. Tolerates a higher ambient light level than many front projection screen surfaces. Moderate viewing cone. Flame and mildew resistant.

## OptiFlex Family of Surfaces

For tensioned screens



OptiFlex surfaces are suitable for tensioning and are available on permanently tensioned screens and tab tensioned roller-operated screens. Choose OptiFlex for the flattest front projection viewing surfaces. All viewing surfaces in this family are compatible with 4K and UHD projectors.

### Matt White XT1000V

#### Extra Wide Viewing Cone / Typical Contrast / On-Axis Gain of 1.0

Unity gain: the perfect matt white diffusing surface. Recommended for use with all types of projectors provided ambient light can be reasonably controlled. Reflects a uniformly bright image over complete 180° viewing cone with precise resolution and accurate color balance. Standard matt white surface on non tab-tensioned screens, including fixed and portable screens.

This surface is GREENGUARD GOLD certified.

### Matt White XT1000VB (Black Backed)

#### Extra Wide Viewing Cone / Typical Contrast / On-Axis Gain of 1.0

Recommended for use with all types of projectors provided ambient light can be reasonably controlled. Reflects a uniformly bright image over complete 180° viewing cone with precise resolution and accurate color balance. **Black backing is standard for matt white surfaces on tab-tensioned screens.**

This surface is GREENGUARD GOLD certified.

### Grey XH600V

#### Extra Wide Viewing Cone / High Contrast / On-Axis Gain of 0.6

Grey front projection surface provides excellent contrast and black reproduction. Intended for use with moderate to high output digital projectors. Grey color enhances color contrast and black levels in the projected image. Also allows for more ambient light in the audience area than matt white surfaces. Relatively broad viewing cone. This surface was previously named "Hi Def Grey."

This surface is GREENGUARD GOLD certified.

### Pure White XT1300V

#### Extra Wide Viewing Cone / Typical Contrast / On-Axis Gain of 1.3

Draper Pure White XT1300V offers a 30% boost in brightness over a traditional matt white surface while still maintaining an extremely wide viewing cone, with half gain angle over 90 degrees. No color shift at any angle, excellent white field uniformity. Pure White XT1300V is a great surface where lighting is well controlled and where enhanced image brightness is needed due to limited projector brightness. Please Note: This surface will contain one or more seams if image area surpasses 144" high.

## Surface Codes

For any surface without a part number, add the surface code to the end of the Matt White part number.

**NOTE: Some surfaces/sizes do not require a surface code and may not use the Matt White Part number as a base.**

OptiFlex Tab-Tensioned Surface	Gain	Code
Matt White XT1000V	1.0	-
Matt White XT1000VB (Black Backed)	1.0	B
Grey XH600V	0.6	FB
Pure White XT1300V	1.3	FN

OptiView NON-Tensioned Surface	Gain	Code
Matt White XT1000E	1.0	-
Contrast Grey XH800E	0.8	EC
Contrast White XH1100E	1.1	EG
Argent White XH1500E	1.5	EH
Pearl White CH1900E	1.9	EJ

Acoustically Transparent Surfaces	Gain	Code
ClearSound White Weave XT900E	0.9	SA
Clearsound Grey Weave XT600E	0.6	SB
ClearSound NanoPerf XT1000V	1.0	SC
ClearSound XT900V	0.9	SD

Acoustically Transparent Surfaces	Gain	Code
CineFlex CH1200V	1.2	CB
CineFlex XT700V	0.7	CD

Contact Draper for more information. For an explanation of surface naming conventions please see "Finding Your Surface" on page 3.

# Viewing Surface Descriptions

## ClearSound Family of Surfaces

All surfaces in the ClearSound family are acoustically transparent. Standard and microscopic perforations are available, and the innovative woven acoustically transparent fabrics—first available through Draper—are also still in the line. The combination of self-supporting and tensioned surfaces means that almost any Draper projection screen model can be provided with a ClearSound surface. ClearSound surfaces should be cut on a bias if 4K+ content is being used. Please advise at time of order.



### ClearSound White Weave XT900E

**Extra Wide Viewing Cone / Typical Contrast / On-Axis Gain of 0.9**

Reflects uniform image over full 180° field with accurate color fidelity.

Acoustical properties are comparable to the highest quality speaker grille cloth. Some control of ambient light is recommended. Flame and mildew resistant. This surface was previously named "AT1200." Not recommended for viewing less than 10' from screen. Maximum Image Height 120".



### ClearSound Grey Weave XH600E

**Extra Wide Viewing Cone / High Contrast / On-Axis Gain of 0.6**

Offers the acoustical properties of ClearSound White Weave XT900E,

while providing the best optical qualities of both matt white and contrast grey screen fabrics. Provides vivid color contrast over a full 180° viewing cone. Flame and mildew resistant. This surface was previously named "AT Grey." Not recommended for viewing less than 10' from screen. Maximum Image Height 120".



### ClearSound NanoPerf XT1000V

**Extra Wide Viewing Cone / Typical Contrast / On-Axis Gain of 1.0**

Microscopic perforations in the fabric create an acoustically transparent surface that does not compromise audio quality when speakers are placed behind the screen, while providing a beautiful image. The projected image is gorgeous, with a full 180° viewing cone and accurate color reproduction. Ideal for home theatre. Not recommended for viewing less than 10' from screen. Maximum Image Height 100".

### ClearSound Perf XT900V

**Extra Wide Viewing Cone / Typical Contrast / On-Axis Gain of 0.9**

Flexible matt white perforated surface. Reasonable control of ambient light is recommended. Not recommended for viewing less than 20' from screen. For shorter viewing distances, or 4K/UHD projection, we recommend ClearSound NanoPerf XT1000V. Maximum Image Height 80".

## CineFlex Family of Surfaces

The CineFlex family offers choices of gain and color to meet a range of rear and dual front/rear projection needs. CineFlex surfaces are available on a wide range of permanently tensioned, portable, and tab tensioned projection screen models.



All Cineflex surfaces are 4K Ready

### CineFlex CH1200V

**Controlled Viewing Cone / High Contrast / On-Axis Gain of 1.2**

Neutral grey rear projection diffusing surface. Provides high resolution and excellent contrast, even in lighted rooms. Recommended for projector throw distances that are 1.4:1 or longer. Moderate viewing cone. This surface was previously named "Cineflex."

### CineFlex White XT700V

**Extra Wide Viewing Cone / Typical Contrast / On-Axis Gain of 0.7**

This white rear projection surface works well for edge blending applications, and also for short throw rear projection. Broad viewing cone and high resolution. Reasonable control of ambient light is recommended. This product can be used as a dual projection surface for front and/or rear projection.

## Backgrounds

### Custom Printed Backgrounds

Many Draper projection screen models can be utilized as high quality video conferencing backdrops or signage with custom printing. Simply submit your completed artwork, and Draper will print your graphics on with high quality CMYK digital printing presses. *See page 107 for details.*

### Chroma Key Backgrounds

Green Chroma Key surfaces are available by quotation—contact your Draper representative. Chroma Key backgrounds (also known as "green screen") are used in video production and video conferencing. Low-gloss Chroma Key Green option is also available by quote. *See page 107 for details.*



## Environmental and Recycling Information

Draper is a leader in the projection screen industry in sustainable products and manufacturing. Not only do we offer products bearing prestigious third party certifications such as GREENGUARD GOLD, but we are also a member of the U.S. Green Building Council and a founding member of the InfoComm AV Sustainability Task Force. We are dedicated to sustainable building.

For information about how to recycle a Draper product or Draper's sustainability initiatives, please call or visit the [Draperinc.com](http://www.draperinc.com) website.

# TecVision® Viewing Surface Descriptions

## TecVision® Family of Viewing Surfaces

TecVision® surfaces are 8K ready, suitable for tensioning and are available on many permanently tensioned screens, or tab tensioned roller-operated screens. Choose TecVision® for unmatched consistency as it pertains to uniformity, gain, contrast, ambient light rejection and gloss. Please call Draper for additional details.



**ALL TecVision® Surfaces are 8K Ready and ISF Certified.**

### XT1000X White

**Extra Wide Viewing Cone / Typical Contrast / On-Axis Gain of 1.0**

This premium optical reference screen surface is engineered for blending applications, precise resolution, color accuracy and a remarkably broad viewing cone. XT1000X White performs best where ambient light is controlled. Like all TecVision® surfaces XT1000X White offers superior quality, consistency, uniformity and is 8K ready. Also available as acoustically transparent perforated or nano perforated in limited sizes.

### XT1100X White

**Extra Wide Viewing Cone / Typical Contrast / On-Axis Gain of 1.1**

Performs best when projector brightness and size of screen require a minimal increase in gain. Like all TecVision® surfaces, XT1100X White offers superior quality and uniformity. Also available as acoustically transparent in limited sizes.

### XT1300X White

**Extra Wide Viewing Cone / Typical Contrast / On-Axis Gain of 1.3**

XT1300X offers an extremely wide viewing cone with no half gain angle. No color shift at any angle, excellent white field uniformity. Recommended for use where lighting is well controlled and enhanced image brightness is needed due to limited projector brightness.

### XT1600X White

**Extra Wide Viewing Cone / Typical Contrast / On-Axis Gain of 1.6**

Offers high reflectivity, while maintaining a broad viewing cone with no half gain angle. Provides excellent resolution and color balance. Consider for use when projector brightness is too low and little ambient light will hit the screen surface.

### XT1800X White



**Extra Wide Viewing Cone / Typical Contrast / On-Axis Gain of 1.8**

Recommended for use where projector brightness is significantly too low, provided ambient light can be reasonably controlled. Consider XT1800X White when active 3D or color combining passive 3D systems will be used. This surface does not reach half gain with a minimum gain of .95.

### XH700X Grey

**Extra Wide Viewing Cone / High Contrast / On-Axis Gain of 0.7**

Recommended for use with ultra-short throw projectors. XH700X Grey, is designed for blending applications on curved or flat screens where ambient light is present.

### XH800X UST ALR Ambient Light Rejecting Surface

**Wide Viewing Cone/High Contrast/On-Axis Gain of 0.8/ ALR: 57%**

Performs well for UST and Short throw projectors in moderate to high ambient light and wide viewing angles. Lens/Throw distance ratio for best brightness uniformity: 0.25:1 or longer.

### XH900X ALR Ambient Light Rejecting Surface

**Extra Wide Viewing Cone/High Contrast/On-Axis Gain of 0.9/ ALR: 60%**

This premium optical surface is engineered for high contrast, precise resolution and color accuracy. XH900X ALR performs very well in spaces where there is moderate ambient light and wide viewing angles. Lens/Throw distance ratio for best brightness uniformity: 1.3:1 or longer.

### MS1000X ALR Ambient Light Rejecting Surface

**Moderate Viewing Cone/Superior Contrast/ On-Axis Gain of 1.0/ALR: 73%**

This premium optical surface is engineered for very high contrast, precise resolution and color accuracy. MS1000X ALR performs very well in spaces where there is moderate to high ambient light and moderate viewing angles.

Lens/Throw distance ratio for best brightness uniformity: 1.5:1 or longer

### CS1000X ALR Ambient Light Rejecting Surface

**Superior Contrast/Narrow Viewing Cone/On-Axis Gain of 1.0 ALR: 82%**

This premium optical surface is engineered for very high contrast, precise resolution and color accuracy. CS1000X ALR performs very well in spaces where there is high ambient light and narrow viewing angles. Like all TecVision® surfaces CS1000X ALR offers superior quality, consistency, uniformity and is 8K ready. Lens/Throw distance ratio for best brightness uniformity: 1.6:1 or longer.

### CS1200X ALR Ambient Light Rejecting Surface

**Narrow Viewing Cone/Superior Contrast/On-Axis Gain of 1.2/ ALR: 80%**

This premium optical surface is engineered for very high contrast, precise resolution and color accuracy. CS1200X ALR performs very well in spaces where there is high ambient light and narrow viewing angles.

Lens/Throw distance ratio for best brightness uniformity: 1.8:1 or longer



### Acoustically Transparent TecVision®

TecVision® premium viewing surfaces are also offered as acoustically transparent. TecVision® NanoPerf (microscopic perforations not recommended for viewing less than 10' from screen) available. (See product page for details.)

## TecVision® Formula Codes

If you would like a TecVision® surface, the suffix codes below should be used at the end of the Matt White XT1000V part number to specify the formula for any screens that have the TecVision® surface available. (Ex. 140039TA for a 137" Access V screen with the TecVision® CS1000X ALR surface.)

TecVision® Surface	Gain	Code
CS1000X ALR	1	TA
CS1200X ALR	1.2	TB
MS1000X ALR	1	TC
XH700X Grey	0.7	TD
XH800X UST ALR	0.8	TY
XH900X ALR	0.9	TE
XT1000X White	1	TF
XT1100X White	1.1	TG
XT1300X White	1.3	TH
XT1600X White	1.6	TJ
XT1800X White	1.8	TK

Acoustically Transparent Surface	Gain	Code
CS1000X ALR NanoPerf	1	TL
CS1200X ALR NanoPerf	1.2	TM
MS1000X ALR NanoPerf	1	TN
XH700X Grey NanoPerf	0.7	TR
XH800X UST ALR NanoPerf	0.8	TZ
XH900X ALR NanoPerf	0.9	TS
XT1000X White NanoPerf	1	TT
XT1100X White NanoPerf	1.1	TU
XT1300X White NanoPerf	1.3	TV
XT1600X White NanoPerf	1.6	TW
XT1800X White NanoPerf	1.8	TX

Contact Draper for more information. For an explanation of surface naming conventions please see "Finding Your Surface" on page 6.

# Screen Size Selection

**One of the most important decisions in screen selection is to determine the correct size of screen based upon:**

1. The dimensions of the audience area.
2. The projection format(s) to be used.

In some situations, these two questions yield the same answer; in others they do not and compromises must be made. Here are the key considerations:

**Audience Area**—In determining the correct screen size in relation to the audience area, the goal is to make the screen large enough so those in the rear of the audience area can read the subject matter easily, but not so large that those in the front of the audience area have difficulty seeing the full width of the projected image.

**Image Height**—Proper image size is determined using the image height based on where people are seated in the audience. Image height is used because regardless of aspect ratio, you want to make sure that font or element height are tall enough.

- Commercial Applications: Image height is dependent on the distance to the farthest viewer and content. AVIXA (formerly Infocomm) has created a standard for proper image size released in 2016 (Display Image Size for 2D Content in AV Systems). If you are not familiar with this standard you should refer to it. A basic way to determine image height for content with mostly smaller fonts is to take the distance to the farthest viewer and divide by 4, or for content with mostly large font in presentations take the distance to the farthest viewer and divide by 4.5.

- Residential Applications: Image height is dependent on the distance to the best seat and content (film, cable, or games). A basic way to determine image height is to take the distance to the best seat and divide by 3.

## Image Height above the Floor

- Commercial Applications: The bottom of the screen should typically be at least 48" above the finished floor in a room with a level floor. Try to make sure that the lower part of the image will be visible by all viewers.
- Residential Applications: The bottom of the screen should typically be at least 36" above the finished floor in a room with a level floor. Try to make sure that the lower part of the image will be visible by all viewers.

Motorized screen applications should have the correct amount of black drop above the image for the bottom of the image to be at the proper height. Draper does not recommend adjusting unused black drop up. You should never adjust a motorized screen down.

**Image Width and Diagonal**—Image width and diagonal are determined by the format of the content and/or projector. Use the image height and the formulas below for these once you have determined the format.

# Projection Formats

**Projection Format**—Once you have determined the image size, that size may be modified based upon the type(s) of projection equipment to be used. If the screen will only be used with one type of projector (4:3, 16:10, 16:9, etc.), it is easy to determine exact screen dimensions based upon the projection format of that projector. Projection formats are expressed in terms of aspect ratio, which is the relationship of the height of the projected image to its width. Aspect ratios of common projection formats are listed below.

Most models of Draper screens are offered in 4:3, 16:10, 16:9 and AV format (square format) aspect ratios. Draper also offers many screens commonly used for projecting native laptop computer displays. We provide almost any Draper screen in the size and projection format of your choice. We can provide any size up to and including the largest published size. If you do not find the size and format you need listed, please call or email your requirements to us, and we will be delighted to quote your request.

**16:10 Format** is a native aspect ratio for some wide computer laptop displays.

**16:9 Format** is also available for high-definition and 4K-UHD projection.

**AV Format** screens are based around an old "square format" that supported overhead projectors and square film photography. AV format screens are described in terms of height x width and are standard without black borders, although borders are optionally available. Screens with Draper's Tab Tensioning System always include black borders and 12" black drop at the top.

**4:3 Format** is strictly defined as a 4:3 rectangle (4 wide by 3 high), and the size is usually described in terms of a nominal diagonal. Conventional models of video format screens are furnished with black borders to frame the image on all four sides, allowing for projector overscan. Draper's standard is to furnish Tab-Tensioned electric screens with black borders at the sides and bottom and 12" of black drop at the top.

**Scope (2.39:1) Format**, the ultimate in home-theater or film-based applications allows projection of movies in their full native width without letterboxing. There are no native scope projectors so this has to be achieved by using an anamorphic lens or zooming out.

**1.9:1**, Movie theaters have switched to digital projectors. All cinema DCI projectors (digital cinema model) have a native aspect ratio of 1.9:1. These projectors can be used to project onto a 1.9:1 screen, or 2.39:1 screen by zooming out or using an anamorphic lens.

**Other formats including 1.85:1 or custom aspect ratios for blending are available by quotation. You can also find the Draper screen selector tool here: [www.draperinc.com/projectionscreens/screensizeselection.aspx](http://www.draperinc.com/projectionscreens/screensizeselection.aspx)**

## Aspect Ratios of Common Projection Formats

W:H	W:H
<b>1.00:1 (AV) Square; overhead projectors, square format film (outdated format)</b>	<b>1.78:1 High-Definition /Ultra-High Definition (16:9): 720p, 1080p, UHD</b>
<b>1.33:1 Standard Definition (4:3): NTSC, SDTV</b>	<b>1.90:1 Full Container; 2K/4K projector native res, DCP Full Container</b>
<b>1.60:1 Wide Computer (16:10): WXGA, WUXGA</b>	<b>2.39:1 Scope: 2K/4K projector with anamorphic lens, DCP Scope</b>

## How to Calculate a Custom Size

Draper manufactures custom size screens to meet your specification. Virtually any size within the maximum shown for a given model is available. Please call for pricing on special sizes. If you need to calculate a custom size, the following formulas may be useful. (D = exact diagonal; H = viewing area height; W = viewing area width)

<b>4:3 Standard Definition NTSC</b>	<b>16:10</b>	<b>16:9 HDTV</b>	<b>1.90:1</b>	<b>2.39:1</b>
H = D x .6	H = D x .5299	H = D x .49	H = D x .46625	H = D x .38625
W = D x .8	W = D x .848	W = D x .87146	W = D x .88375	W = D x .92375
D = H x 1.667	D = H x 1.8868	D = H x 2.04	D = H x 2.14375	D = H x 2.59125
D = W x 1.25	D = W x 1.1793	D = W x 1.1475	D = W x 1.13	D = W x 1.08375

# Electric Screens

## Tab-Tensioned and Self-Supporting Electric Projection Screens

Several Draper models feature Draper's Tab-Tensioning System with unsupported vinyl viewing surfaces. These screens feature surfaces from the OptiFlex family that offer a perfectly flat projection surface, suitable for even the most demanding applications. TecVision®, CineFlex, and ClearSound surfaces may also be available. Computer-driven data and graphics presentations, as well as large-screen video images, Short Throw, and Ultra-Short Throw projection lenses always look their best on a tensioned screen.

Self-supporting (non-tensioned) electric screens are manufactured with textile-backed materials. These screens offer surfaces from the OptiView and ClearSound families that remain flat by virtue of the thickness and weight of the screen surface and dowel. An important part of Draper's inspection process for screens of this type is to make sure the screen is as flat as possible.

Self-supporting screens in AV format are normally furnished without black borders, while these screens in all other formats include borders to frame the image on all four sides. Self-supporting HDTV and 16:10 formats have 12" of black drop as standard in screen sizes 113" diagonal and smaller. Standard tab-tensioned screens in all formats are furnished with black borders at the sides and bottom and 12" black drop at top. Custom tab-tensioned screens are furnished with black borders at sides and bottom. Extra drop may be specified as needed. Additional black masking above the image area is optionally available for all standard and custom screens.

## Tab-Tensioned Electric Screens

### Ceiling-Recessed Electric Screens

**Access V**—Tab-tensioned screen for ceiling-recessed installation. "Plug-in" wiring connections enable installation of case early in construction and screen later. No exposed fasteners. Suitable for use in return air plenum. Sizes through 16' wide.

**Access FIT V**—Tab-tensioned screen for ceiling-recessed installation with a "slim" case design. Sizes through 8' 8" wide depending on surface.

**Access XL V**—Draper's popular Access projection screen available in larger sizes. Sizes through 18' wide.

**Ultimate Access V**—All the features of the Access, plus an independently motorized ceiling closure that opens into the case. Sizes through 12' wide.

**Ultimate Access XL V**—All the features of the Access, plus an independently motorized ceiling closure that opens into the case. Sizes through 22' wide.

### Wall- or Ceiling-Mounted Electric Screens

**Premier**—Our most popular tab-tensioned electric screen. The Premier is housed in a black pentagonal steel case and utilizes a quiet tubular motor-in-roller design. Sizes through 12' wide.

**Premier XL**—Our most popular tab-tensioned electric screen. The Premier is housed in a black pentagonal steel case and utilizes a quiet tubular motor-in-roller design. Sizes through 16' wide.

**Silhouette V**—Tab-tensioned screen for wall/ceiling installation, with streamlined extruded aluminum case. No exposed fasteners or mounting fixtures. Sizes through 96" wide.

### Heavy-Duty Electric Screens

**Paragon V**—Features extruded white aluminum case standard. Operates on a 6" steel roller powered by a strong tubular motor-in-roller. Sizes up to 24' wide.

### Ceiling-Recessed Cable-Lowered Screen

**Ropewalker**—Ceiling recessed housing, lowers projection screen up to 34' below the ceiling, eliminating the need for extra black drop. Available in Tab-Tensioned and Self-supporting. See page 34.

## Self-Supporting Electric Screens

### Ceiling-Recessed Electric Screens

**Access E**—Motor-in-roller electric screen for ceiling-recessed installation. Suitable for use in return air plenum. "Plug-in" wiring connections enable installation of case early in construction and screen later. Sizes through 16' wide.

**Access FIT E**—Free hanging electric screen for ceiling-recessed installation with a "slim" case design. Sizes through 10' wide depending on surface.

**Access XL E**—Draper's popular Access projection screen available in larger sizes. Sizes through 20' wide.

**Ultimate Access E**—All the features of the Access, plus an independently motorized ceiling closure that opens into the case. Sizes through 12' wide.

**Ultimate Access XL E**—All the features of the Access, plus an independently motorized ceiling closure that opens into the case. Sizes through 22' wide.

### Wall- or Ceiling-Mounted Electric Screens

**Targa**—Popular electric screen. Housed in a pentagonal steel case, finished white. Very reasonably priced; powered by a quiet tubular motor-in-roller. Sizes through 12' wide.

**Targa XL**—Popular electric screen. Housed in a pentagonal steel case, finished white. Very reasonably priced; powered by a quiet tubular motor-in-roller. Sizes through 160" wide.

**Silhouette E**—Viewing surfaces from the OptiView and ClearSound families with motor-in-roller, housed in a strikingly contemporary extruded aluminum case. Sizes through 96" wide.

**Salara**—Elliptical extruded aluminum case with white finish installs quickly to wall brackets. Hardwired and Plug & Play™ versions available. Plug & Play comes with 10' power cord and IR remote, so no wiring is needed. Conventional electric screen with motor-in-roller. Sizes through 96" wide.

### Outdoor Electric Screens

**Nocturne+® E**—Designed for outdoor use on your patio, by your pool deck, or any other outdoor space. Weather and insect-resistant solid aluminum headbox includes built-in hinge for easy installation and service. Includes cable guides, weighted dowel, and both wall and deck mount cable guide brackets. Sizes through 132" wide with custom quote.

### Heavy-Duty Electric Screens

**Paragon E**—Features extruded white aluminum case standard. Operates on a 6" steel roller powered by an extremely strong tubular motor-in-roller. Sizes through 28' wide.

**Rolleramic**—Heavy-duty electric screen housed in a square case of high compression wood particle board painted flat black with end mounted motor and direct drive. Sizes through 20' wide.



# Overall Screen Width Breakdown for Ceiling/Wall Mount Cases

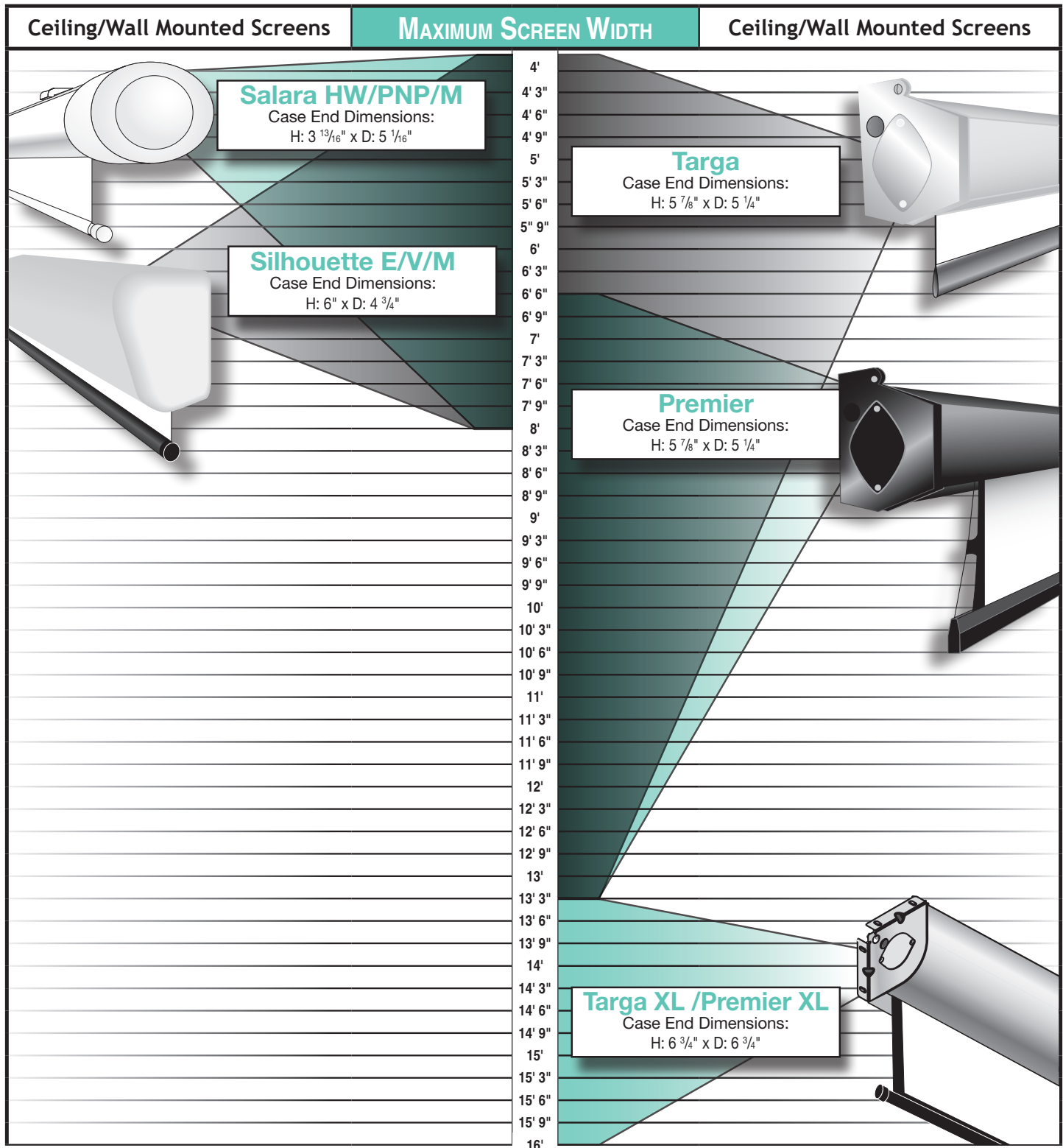

# Overall Screen Width Breakdown for Ceiling-Recessed Cases

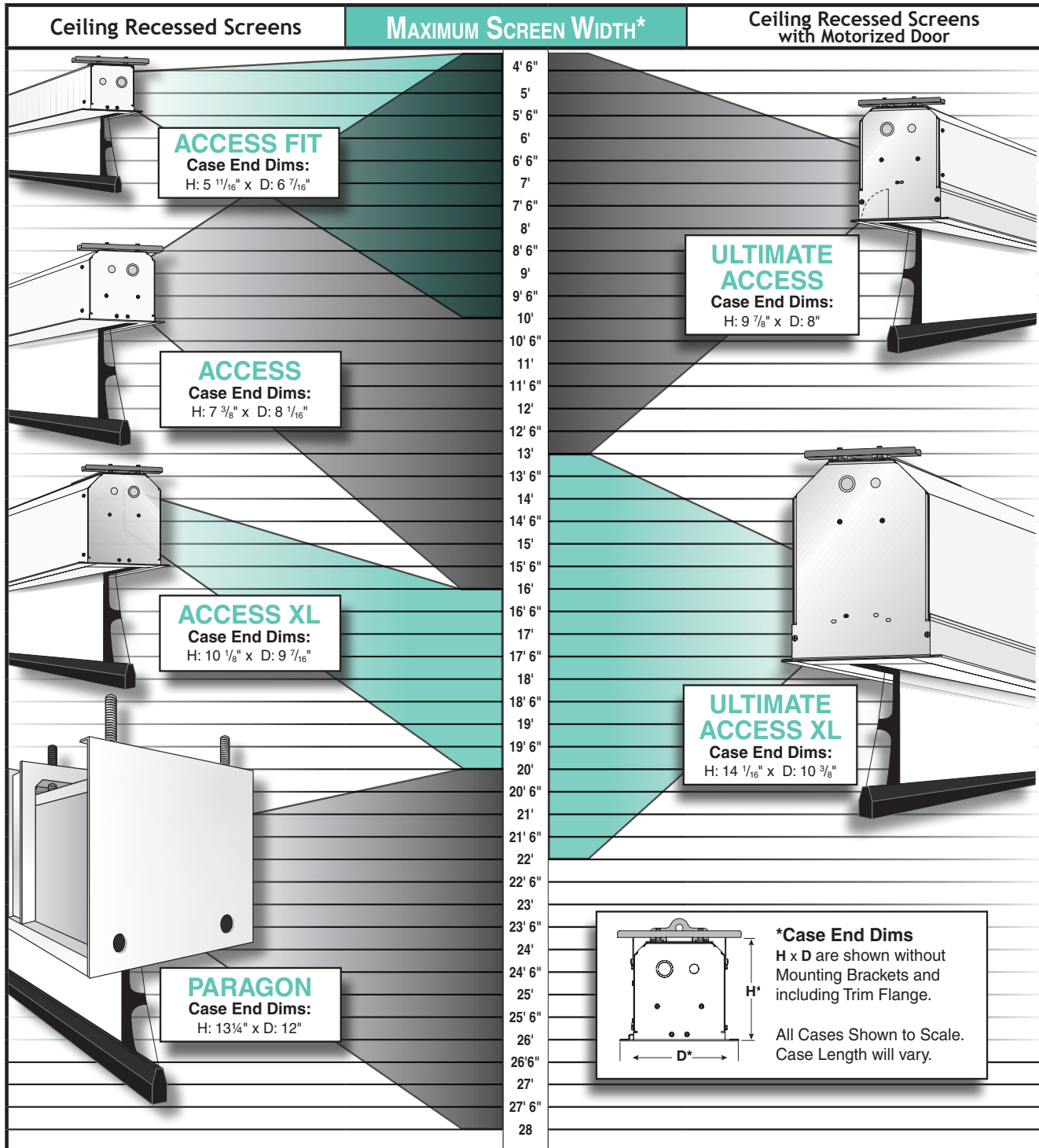

## The Access Family: Case Now, Screen Later.

You can install the case during the "dirty" phase of the construction process and keep the screen safe until you install the projector. Screen (motor-in-roller and attached viewing surface) installs in seconds with preset latching roller brackets and electrical pin connectors. Eliminates job site damage. Screens may be installed in cases up to 20" wider than the standard case lengths shown. *Note: Due to hardware restrictions we are unable to ship case only for Access XL and Ultimate Access XL.*

**Options:** Some optional controls, including LVC-IV, may be built into the case: see page 35 for information and pricing. Built-in controls may reduce available space for the screen: call Draper for dimensions. All ceiling recessed cases can be painted black upon request at an additional cost.

**Important Notice for Compatibility**—If you are planning to install an Access case first and screen later, and you want any of the built-in Low-Voltage Motor or Control options, you must specify when ordering the case to assure compatibility with your screen.

Access Case	PRICE
Access FIT	\$760
Access	760
Ultimate Access	960

**Cases may be ordered and pre-installed. If ordering case in advance of screen, price of case will be deducted when screen is ordered. Specify case length at time of order. If you are unsure of future size, call Draper for suggestions or use printed size information for your most logical choice.**

## Slim, tab-tensioned, ceiling-recessed electric screen

The Access FIT V features a lower-profile case to fit in smaller spaces. The hinged door cover makes installation and service easier. Access FIT V is tab-tensioned for ceiling-recessed installation. White finished case. "Plug-in" wiring connections allow installation of case early and screen later. Plenum rated case (UL approved "Suitable for Use in Environmental Air Space"). Includes one 110-120V 3-position switch. An Access FIT case may be ordered and installed prior to selecting a screen size, type, and format. Please see page 10 for cases.

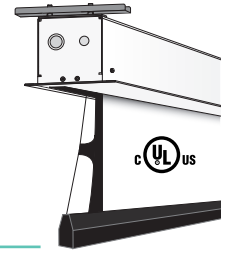

ELECTRIC SCREENS

### STANDARD SPECS

- **Sizes and Formats:** Custom sizes by quotation. Custom sizes need to be specified in detail, including extra drop, if desired.
- **Case Dimensions:** Case Dimensions 5 11/16" high x 6 7/16" deep including trim flange. Mounting brackets may add to both dimensions, see Submittal in the Technical Documents tab at www.draperinc.com for details.
- **Black Borders:** Image area fully framed with black. 12" black drop at top of viewing surface (standard).

### OPTIONS

- **Motor/Control Options:** Quiet Motor (Q), or Built-in Low-Voltage Controller (U or L) available. See page 35 for details. 220V motor is also available at no extra cost.
- **Case Options:** For more information on how to order case in advance of screen, see page 9. Black case available on request at an additional cost.
- **Extra Drop:** Additional drop above image (specify color—12" black is standard; surface color available on request). May increase case length. See page 36.

**Viewing Surfaces:** CineFlex CH1200V (CB), and CineFlex White XT700V (CD) rear projection surfaces available by quotation—add 2-letter suffix noted above to any Matt White XT1000VB part number. Also available: ClearSound Perf XT900V, a perforated matt white—add the suffix SD to any Matt White XT1000VB part number. See page 5.

H x W / Diagonal	Image Area	OptiFlex Viewing Surfaces				ClearSound Surface		Case Length	Ship Wt./lbs.	Freight Class
		Matt White XT1000VB	Grey XH600V	Pure White XT1300V	PRICE	ClearSound NanoPerf XT1000V	PRICE			
<b>16:10 Format</b>										
94"	50" x 80"	140035	140035FB	140035FN	\$3192	140035SC	\$3572	105 1/8"	95	125
109"	57 1/2" x 92"	140036	140036FB	140036FN	3489	140036SC	3872	118 1/8"	104	125
113"	60" x 96"	140037	140037FB	140037FN	3666	140037SC	4047	122 1/8"	108	125
123"	65" x 104"	140038	140038FB	140038FN	3814	140038SC	4193	130 1/8"	110	125
<b>16:9 HDTV Format</b>										
92"	45" x 80"	140025	140025FB	140025FN	\$3192	140025SC	\$3572	105 1/8"	91	125
100"	49" x 87"	140026	140026FB	140026FN	3374	140026SC	3754	112 1/8"	101	125
106"	52" x 92"	140027	140027FB	140027FN	3489	140027SC	3872	117 1/8"	104	125
110"	54" x 96"	140028	140028FB	140028FN	3666	140028SC	4047	122 1/8"	108	125
119"	58" x 104"	140029	140029FB	140029FN	3814	140029SC	4193	130 1/8"	111	125
<b>4:3 NTSC Video Format</b>										
7'	50" x 66 1/2"	140015	140015FB	140015FN	\$2991	140015SC	\$3372	91 1/8"	79	125 P+
100"	60" x 80"	140016	140016FB	140016FN	3267	140016SC	3649	106 1/8"	95	125
10'	72" x 96"	140017	140017FB	140017FN	3561	140017SC	3941	123 1/4"	109	125
11'	78" x 104"	140018	140018FB	140018FN	3899	140018SC	4279	131 1/4"	109	125
<b>AV Format</b>										
70" x 70"		140003	140003FB	140003FN	\$3156	140003SC	\$3529	97 1/4"	85	125
84" x 84"		140004	140004FB	140004FN	3494	140004SC	3867	111 1/4"	94	125
72" x 96"		140017	140017FB	140017FN	3561	140017SC	--	123 1/4"	109	125



\*\* To order a screen with a TecVision® surface, the suffix codes should be added to the end of the Matt White XT1000VB part number. (Ex. 140035TA for a 94" screen with the TecVision® CS1000X ALR surface.) See page 6 for full descriptions and formula codes of all available TecVision® surfaces.

### TecVision® Viewing Surfaces

H x W / Diagonal	Image Area	TecVision®		Case Length	Ship Wt./lbs.	Freight Class
		TecVision®	PRICE			
<b>16:10 Format</b>						
94"	50" x 80"	140035**	\$4119	105 1/8"	95	125
109"	57 1/2" x 92"	140036**	4714	118 1/8"	104	125
113"	60" x 96"	140037**	4999	122 1/8"	108	125
123"	65" x 104"	140038**	5381	130 1/8"	110	125
<b>16:9 HDTV Format</b>						
92"	45" x 80"	140025**	\$4026	105 1/8"	91	125
100"	49" x 87"	140026**	4361	112 1/8"	101	125
106"	52" x 92"	140027**	4596	117 1/8"	104	125
110"	54" x 96"	140028**	4866	122 1/8"	108	125
119"	58" x 104"	140029**	5211	130 1/8"	111	125
<b>4:3 NTSC Video Format</b>						
7'	50" x 66 1/2"	140015**	\$3761	91 1/8"	79	125 P+
100"	60" x 80"	140016**	4379	106 1/8"	95	125
10'	72" x 96"	140017**	5161	123 1/4"	105	125
11'	78" x 104"	140018**	5778	131 1/4"	109	125

### Freight Class Key

**Number** LTL freight class  
**P** Parcel Service  
**+** \$15 surcharge (over 48" long)

**Example:** A freight code of 125 P+ indicates a item that may ship as freight class 125 or via parcel service with \$15 surcharge.

**Note:** for alternate installation of Access FIT screens, additional set (pair) of brackets is required. Part No. C502.233.

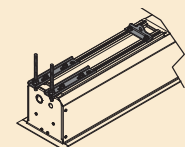

# Access V

## Tab-tensioned, ceiling-recessed electric screen

Access now comes in larger sizes, up to 16' wide, with an efficient profile to maximize space. The hinged door cover makes installation and service easier. Access V is tab-tensioned for ceiling-recessed installation. White finished case. "Plug-in" wiring connections allow installation of case early and screen later. Plenum rated case (UL approved "Suitable for Use in Environmental Air Space"). Includes one 110-120v 3-position switch. An Access case may be ordered and installed prior to selecting a screen size, type, and format. *Please see page 10 for cases.*

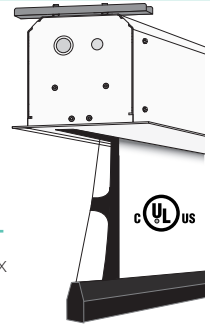

### STANDARD SPECS

- **Sizes and Formats:** Custom sizes by quotation. Custom sizes need to be specified in detail, including extra drop, if desired.
- **Case Dimensions:** Case Dimensions 7 3/8" high x 8 1/16" deep including trim flange. Mounting brackets may add to both dimensions, see Submittal in the Technical Documents tab at [www.draperinc.com](http://www.draperinc.com) for details. Extra drop may increase case size: call for dimensions.
- **Black Borders:** Image area fully framed with black. 12" black drop at top of viewing surface (standard).

### OPTIONS

- **Motor/Control Options:** Quiet Motor (Q), or Built-in Low-Voltage Controller (U or L) available. See page 35 for details. 220V motor is also available.
- **Case Options:** For more information on how to order case in advance of screen, see page 10. Black case available on request at an additional cost.
- **Extra Drop:** Additional drop above image (specify color—12" black is standard; surface color available on request). May increase case length. See page 36.
- **Viewing Surfaces:** CineFlex CH1200V (CB), and CineFlex White XT700V (CD) rear projection surface available by quotation—add 2-letter suffix noted above to any Matt White XT1000VB part number. Also available: ClearSound Perf XT900V, a perforated matt white—add the suffix SD to any Matt White XT1000VB part number. See page 5.

H x W / Diagonal	Image Area	OptiFlex Viewing Surfaces				ClearSound Surfaces			TecVision® Surfaces				Case Length	Ship Wt.	Freight Class	
		Matt White XT1000VB	Grey XH600V	Pure White XT1300V	PRICE	ClearSound NanoPerf XT1000V	ClearSound Perf XT900V	PRICE	TecVision®	PRICE	TecVision® NanoPerf	PRICE				
<b>16:10 Format</b>																
94"	50" x 80"	140111	140111FB	140111FN	\$3416	140111SC	140111SD	\$3587	140111**	\$4343	140111**	\$4514	103 3/8"	86	125	
109"	57 1/2" x 92"	140112	140112FB	140112FN	3712	140112SC	140112SD	3899	140112**	4938	140112**	5124	116 3/8"	97	125	
113"	60" x 96"	140113	140113FB	140113FN	3889	140113SC	140113SD	4084	140113**	5223	140113**	5418	120 3/8"	92	125	
123"	65" x 104"	140114	140114FB	140114FN	4037	140114SC	140114SD	4239	140114**	5604	140114**	5806	128 3/8"	106	125	
137"	72 1/2" x 116"	140039	140039FB	140039FN	4152	140039SC	140039SD	4524	140039**	6100	140039**	6471	141 1/2"	148	125	
165"	87 1/2" x 140"	140040	140040FB	140040FN	5304	140040SC	--	5676	140040**	8140	140040**	8512	167"	174	125	
189"	100" x 160"	140089	140089FB	140089FN	6215	140089SC	--	6586	140089**	9917	--	--	187"	304	125	
198"	105" x 168"	140042	140042FB	140042FN	9292	--	--	--	140042**	13376	--	--	195 1/2"	383	125	
226"	120" x 192"	140043	140043FB	140043FN	9727	--	--	--	140043**	15061	--	--	221 1/8"	419	125	
<b>16:9 HDTV Format</b>																
92"	45" x 80"	140106	140106FB	140106FN	\$3416	140106SC	140106SD	\$3587	140106**	\$4249	140106**	\$4421	103 3/8"	86	125	
100"	49" x 87"	140107	140107FB	140107FN	3597	140107SC	140107SD	3777	140107**	4584	140107**	4764	110 3/8"	90	125	
106"	52" x 92"	140108	140108FB	140108FN	3712	140108SC	140108SD	3899	140108**	4819	140108**	5006	115 3/8"	98	125	
110"	54" x 96"	140109	140109FB	140109FN	3889	140109SC	140109SD	4084	140109**	5089	140109**	5284	120 3/8"	105	125	
119"	58" x 104"	140110	140110FB	140110FN	4037	140110SC	140110SD	4239	140110**	5434	140110**	5636	128 3/8"	107	125	
133"	65" x 116"	140030	140030FB	140030FN	4152	140030SC	140030SD	4524	140030**	5900	140030**	6271	140 3/8"	151	125	
161"	79" x 140"	140031	140031FB	140031FN	5304	140031SC	140031SD	5676	140031**	7865	140031**	8237	165 1/2"	173	125	
184"	90" x 160"	140087	140087FB	140087FN	6215	140087SC	--	6586	140087**	9549	140087**	9920	187"	255	125	
193"	94 1/2" x 168"	140033	140033FB	140033FN	9292	140033SC	--	9667	140033**	12969	--	--	195"	375	125	
220"	108" x 192"	140034	140034FB	140034FN	9622	--	--	--	140034**	14423	--	--	219 1/2"	667	125	
<b>4:3 NTSC Video Format</b>																
7"	50" x 66 1/2"	140102	140102FB	140102FN	\$3177	140102SC	140102SD	\$3336	140102**	\$3947	140102**	\$4106	89 7/8"	79	125	
100"	60" x 80"	140103	140103FB	140103FN	3416	140103SC	140103SD	3587	140103**	4528	140103**	4699	104 3/8"	95	125	
10'	72" x 96"	140104	140104FB	140104FN	3889	140104SC	140104SD	4084	140104**	5489	140104**	5684	121 1/2"	105	125	
11'	78" x 104"	140105	140105FB	140105FN	4037	140105SC	140105SD	4239	140105**	5916	140105**	6118	129 1/2"	109	125	
150"	87" x 116"	140019	140019FB	140019FN	4246	140019SC	--	4619	140019**	6583	140019**	6956	143"	125	125	
15'	108" x 144"	140020	140020FB	140020FN	5431	--	--	--	140020**	9032	--	--	171 1/2"	159	125	
200"	118" x 158"	140091	140091FB	140091FN	6253	--	--	--	140091**	10569	--	--	187 1/8"	370	125	
210"	126" x 168"	140022	140022FB	140022FN	9174	--	--	--	140022**	14074	--	--	197 1/8"	381	125	
220"	132" x 176"	140023	140023FB	140023FN	9449	--	--	--	140023**	14828	--	--	205 1/8"	665	125	
240"	144" x 192"	140024	140024FB	140024FN	9727	--	--	--	140024**	16128	--	--	222 7/8"	689	125	
<b>AV Format</b>																
96" x 96"		140005	140005FB	140005FN	\$3861	140005SC	--	\$4236	--	--	--	--	123"	135	125	
7' x 9'		140006	140006FB	140006FN	3979	140006SC	--	4353	--	--	--	--	133 1/2"	143	125	
9' x 9'		140007	140007FB	140007FN	4276	--	--	--	--	--	--	--	135 1/2"	161	125	
8' x 10'		140008	140008FB	140008FN	4363	140008SC	--	4736	--	--	--	--	147"	191	125	
10' x 10'		140009	140009FB	140009FN	4761	--	--	--	--	--	--	--	149 1/8"	158	125	
10'6" x 14"		140011	140011FB	140011FN	5893	--	--	--	--	--	--	--	197 1/8"	637	125	
12' x 12'		140010	140010FB	140010FN	9245	--	--	--	--	--	--	--	197 1/8"	214	125	
14' x 14'		140012	140012FB	140012FN	9449	--	--	--	--	--	--	--	205 1/8"	402	125	
12' x 16'		140013	140013FB	140013FN	9794	--	--	--	--	--	--	--	222 7/8"	689	125	



\*\* To order a screen with a TecVision® surface, the suffix codes should be added to the end of the Matt White XT1000VB part number. (Ex. 140039TA for a 137" screen with the TecVision® CS1000X ALR surface.) See page 6 for full descriptions and formula codes of all available TecVision® surfaces.

**Note:** for alternate installation of Access screens, additional set (pair) of brackets is required. Part No. C502.240

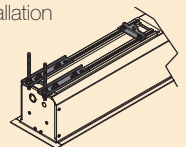

## XL tab-tensioned, ceiling-recessed electric screen

The Access XL line of Tab-Tensioned projection screens are motorized, ceiling-recessed, and offer the same great features as other Access screens—in a range of large sizes. Includes one 110-120V 3-position switch. Case lengths below include flange to support ceiling tile or trim ceiling opening. Plenum rated case (UL approved "Suitable for Use in Environmental Air Space"). Viewing surfaces from the OptiFlex, CineFlex, and TecVision® families.

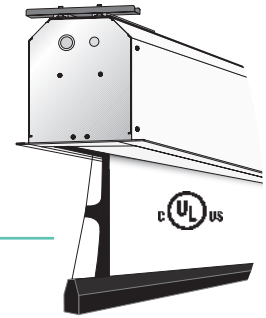

ELECTRIC SCREENS

### STANDARD SPECS

- **Sizes and Formats:** Custom sizes by quotation. Custom sizes need to be specified in detail, including extra drop, if desired.
- **Case Dimensions:** Case Dimensions 10 1/8" high x 9 7/16" deep including trim flange. Mounting brackets may add to both dimensions.
- **Black Borders:** Image area fully framed with black. 12" black drop at top of viewing surface (standard).

### OPTIONS

- **Motor/Control Options:** Built-in Low-Voltage Controller (U or L) available. See page 35 for details. 220V motor is also available.
- **Case Options:** Black case available on request at an additional cost.
- **Extra Drop:** Additional drop above image area optional (specify color—black is standard; surface color available upon request). Extra drop may increase case length. See page 36.

- **Viewing Surfaces:** CineFlex CH1200V (CB), and CineFlex White XT700V (CD) rear projection surfaces available by quotation—add 2-letter suffix noted above to any Matt White XT1000VB part number. See page 5.

H x W/ Diagonal	Image Area	OptiFlex Viewing Surfaces				Case Length	Shipping Wt. /lbs.	Freight Class
		Matt White XT1000VB	Grey XH600V	Pure White XT1300V	PRICE			
<b>16:10 Format</b>								
255"	135" x 216"	147007	147007FB	147007FN	\$11052	246 5/8"	702	125
<b>16:9 HDTV Format</b>								
248"	121 1/2" x 216"	147006	147006FB	147006FN	\$11052	244 7/8"	510	125
<b>4:3 NTSC Video Format</b>								
250"	148" x 198"	147004	147004FB	147004FN	\$10317	228 5/8"	653	125
270"	162" x 216"	147005	147005FB	147005FN	11276	248 5/8"	707	125
<b>AV Format</b>								
16' x 16'		147001	147001FB	147001FN	\$10795	229"	480	125
13' 6" x 18'		147002	147002FB	147002FN	11209	248 5/8"	707	125
18' x 18'		147003	147003FB	147003FN	12146	254 7/8"	724	125

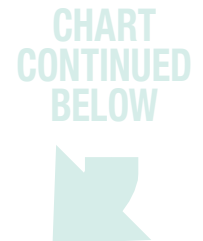

\*\* To order a screen with a TecVision® surface, the suffix codes should be added to the end of the Matt White XT1000VB part number. (Ex. 147007TA for a 255" screen with the TecVision® CS1000X ALR surface.) See page 6 for full descriptions and formula codes of all available TecVision® surfaces.

H x W/ Diagonal	Image Area	TecVision® Viewing Surfaces		Case Length	Shipping Wt. /lbs.	Freight Class
		TecVision®	PRICE			
<b>16:10 Format</b>						
255"	135" x 216"	147007**	\$17804	246 5/8"	702	125
<b>16:9 HDTV Format</b>						
248"	121 1/2" x 216"	147006**	\$17125	244 7/8"	510	125
<b>4:3 NTSC Video Format</b>						
250"	148" x 198"	147004**	\$17100	228 5/8"	653	125
270"	162" x 216"	147005**	19377	248 5/8"	707	125

**Note:** for alternate installation of Access XL screens, additional set (pair) of brackets is required. Part No. C502.281

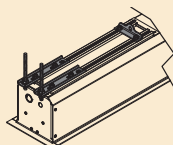

**Freight Class Key**

<b>Number</b>	LTL freight class
<b>P</b>	Parcel Service
<b>+</b>	\$15 surcharge (over 48" long)

**Example:** A freight code of 125 P+ indicates a item that may ship as freight class 125 or via parcel service with \$15 surcharge.

# Ultimate Access V

## Tab-tensioned electric screen with motorized closure

Tab-tensioned screen for ceiling-recessed installation. White finished folded steel case with "plug-in" wiring connections that enable installation of case early in construction, and viewing surface later. Independently motorized ceiling closure opens into the case. No exposed fasteners. Plenum rated case (UL approved "Suitable for Use in Environmental Air Space"). Includes one 110-120v 3-position switch. Left hand motor location only. Viewing surfaces from the OptiFlex, CineFlex, and TecVision® families.

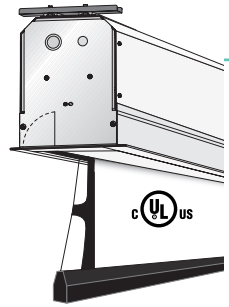

**An Ultimate Access case may be ordered and installed prior to selecting a screen size, type and format.**  
Please see page 10 for cases.

### STANDARD SPECS

- **Sizes and Formats:** Custom sizes by quotation. Custom sizes need to be specified in detail, including extra drop, if desired.
- **Case Dimensions:** Case Dimensions 9 7/8" high x 8" deep including trim flange. Mounting brackets may add to both dimensions, see Submittal in the Technical Documents tab at [www.draperinc.com](http://www.draperinc.com) for details. Extra drop will increase length of case: Call Draper for dimensions.
- **Black Borders:** Image area fully framed with black. 12" black drop at top of viewing surface (standard).

### OPTIONS

- **Motor/Control Options:** Quiet Motor (Q), or Built-in Low-Voltage Controller (U or L) available. See page 35 for details. 220V motor is also available at no extra cost.
- **Case Options:** For more information on how to order case in advance of screen, see page 10. All ceiling recessed cases can be painted black upon request at an additional cost.
- **Extra Drop:** Additional drop above image (specify color—12" black is standard; surface color available on request). Extra drop may increase case length. See page 36.

- **Viewing Surfaces:** CineFlex CH1200V (CB), and CineFlex White XT700V (CD) rear projection surfaces available by quotation—add 2-letter suffix noted above to any Matt White XT1000VB part number. Also available: ClearSound Perf XT900V, a perforated matt white—add the suffix SD to any Matt White XT1000VB part number. See page 5.

**Note:** for alternate installation of Ultimate Access screens, additional set (pair) of brackets is required. Part No.C502.279

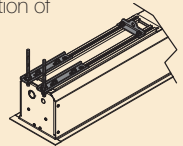

**TECVISION®** \*\* To order a screen with a TecVision® surface, the suffix codes should be added to the end of the Matt White XT1000VB part number.

(Ex. 143025TA for a 94" screen with the TecVision® CS1000X ALR surface.)

See page 6 for full descriptions and formula codes of all available TecVision® surfaces.

H x W / Diagonal	Image Area	OptiFlex Viewing Surfaces				TecVision® Surfaces		Case Length	Ship Wt./lbs.	Freight Class
		Matt White XT1000VB	Grey XH600V	Pure White XT1300V	PRICE	TecVision®	PRICE			
<b>16:10 Format</b>										
94"	50" x 80"	143025	143025FB	143025FN	\$5314	143025**	\$6241	103 3/8"	128	125
109"	57 1/2" x 92"	143026	143026FB	143026FN	5546	143026**	6771	116 3/8"	135	125
113"	60" x 96"	143027	143027FB	143027FN	5768	143027**	7101	120 3/8"	143	125
123"	65" x 104"	143028	143028FB	143028FN	6195	143028**	7762	128 3/8"	149	125
137"	72 1/2" x 116"	143029	143029FB	143029FN	6658	143029**	8605	141 1/2"	163	125
165"	87 1/2" x 140"	143030	143030FB	143030FN	7143	143030**	9979	167"	230	125
<b>16:9 HDTV Format</b>										
92"	45" x 80"	143018	143018FB	143018FN	\$5314	143018**	\$6148	103 3/8"	128	125
100"	49" x 87"	143019	143019FB	143019FN	5441	143019**	6428	110 3/8"	137	125
106"	52" x 92"	143020	143020FB	143020FN	5546	143020**	6653	115 3/8"	162	125
110"	54" x 96"	143021	143021FB	143021FN	5768	143021**	6968	120 3/8"	164	125
119"	58" x 104"	143022	143022FB	143022FN	6195	143022**	7592	128 3/8"	166	125
133"	65" x 116"	143023	143023FB	143023FN	6658	143023**	8405	140 3/8"	189	125
161"	79" x 140"	143024	143024FB	143024FN	7143	143024**	9704	165 1/2"	224	125
<b>4:3 NTSC Video Format</b>										
7"	50" x 66 1/2"	143012	143012FB	143012FN	\$5019	143012**	\$5789	89 7/8"	124	125 P+
100"	60" x 80"	143013	143013FB	143013FN	5386	143013**	6498	104 3/8"	135	125
10'	72" x 96"	143014	143014FB	143014FN	5646	143014**	7246	121 1/2"	145	125
11'	78" x 104"	143015	143015FB	143015FN	6376	143015**	8255	129 1/2"	177	125
150"	87" x 116"	143016	143016FB	143016FN	6691	143016**	9028	143"	224	125
15'	108" x 144"	143017	143017FB	143017FN	7231	143017**	10832	171 1/2"	238	125
<b>AV Format</b>										
70" x 70"		143003	143003FB	143003FN	\$5681	--	--	95 1/2"	115	125
84" x 84"		143004	143004FB	143004FN	5965	--	--	109 1/2"	130	125
72" x 96"		143014	143014FB	143014FN	5646	--	--	121 1/2"	147	125
96" x 96"		143005	143005FB	143005FN	6105	--	--	123"	152	125
7' x 9'		143006	143006FB	143006FN	6250	--	--	133 1/2"	160	125
9' x 9'		143007	143007FB	143007FN	6526	--	--	135 1/2"	165	125
8' x 10'		143008	143008FB	143008FN	6756	--	--	147"	172	125
10' x 10'		143009	143009FB	143009FN	7031	--	--	149 1/8"	180	125
9' x 12'		143017	143017FB	143017FN	7231	--	--	171 1/2"	190	125
12' x 12'		143010	143010FB	--	8958	--	--	174 7/8"	199	125

# Ultimate Access XL V

**ELECTRIC SCREENS**  
CEILING-RECESSED

## XL tab-tensioned electric screen with motorized closure

Tab-tensioned screen for ceiling-recessed installation. White finished folded steel case. Independently motorized ceiling closure opens into the case. No exposed fasteners. Plenum rated case (UL approved "Suitable for Use in Environmental Air Space"). Includes one 110-120v 3-position switch. Left hand motor location only. Viewing surfaces from the OptiFlex, CineFlex, and TecVision® families.



ELECTRIC SCREENS

### STANDARD SPECS

- **Sizes and Formats:** Custom sizes by quotation. Custom sizes need to be specified in detail, including extra drop, if desired.
- **Case Dimensions:** Case Dimensions 14-1/16" high x 10-3/8" deep including trim flange. Mounting brackets may add to both dimensions, see Submittal in the Technical Documents tab at [www.draperinc.com](http://www.draperinc.com) for details. Extra drop will increase length of case: call Draper for dimensions.
- **Black Borders:** Image area fully framed with black. 12" black drop at top of viewing surface (standard).

### OPTIONS

- **Motor/Control Options:** Built-in Low-Voltage Controller (U) available. See page 35 for details. 220V motor is also available at no extra cost.
- **Case Options:** All ceiling recessed cases can be painted black upon request at an additional cost.
- **Extra Drop:** Additional drop above image (specify color—12" black is standard; surface color available on request). Extra drop may increase case length. See page 5.

- **Viewing Surfaces:** CineFlex CH1200V (CB), and CineFlex White XT700V (CD) rear projection surfaces available by quotation—add 2-letter suffix noted above to any Matt White XT1000VB part number. Also available: ClearSound Perf XT900V, a perforated matt white—add the suffix SD to any Matt White XT1000VB part number. See page 5.

**TECVISION®** \*\* To order a screen with a TecVision® surface, the suffix codes should be added to the end of the Matt White XT1000VB part number.

(Ex. 145001TA for a 189" screen with the TecVision® CS1000X ALR surface.)

See page 6 for full descriptions and formula codes of all available TecVision® surfaces.

**Note:** for alternate installation of Ultimate Access XL screens, additional set (pair) of brackets is required. Part No. C502.280.

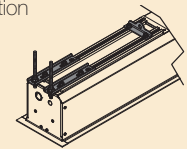

H x W / Diagonal	Image Area	OptiFlex Viewing Surfaces			TecVision® Viewing Surfaces		Case Length	Ship Wt./lbs.	Freight Class	
		Matt White XT1000VB	Grey XH600V	Pure White XT1300V	PRICE	TecVision®				PRICE
<b>16:10 Format</b>										
189"	100" x 160"	145001	145001FB	145001FN	\$10969	145001**	\$14671	186 3/4"	574	125
198"	105" x 168"	145002	145002FB	145002FN	11546	145002**	15630	195 1/4"	580	125
226"	120" x 192"	145003	145003FB	145003FN	12106	145003**	17440	220 7/8"	620	125
234"	124" x 198"	145004	145004FB	145004FN	12628	145004**	18310	226 7/8"	631	125
255"	135" x 216"	145005	145005FB	145005FN	13673	145005**	20424	246 5/8"	661	125
278"	147 1/2" x 236"	145006	145006FB	145006FN	14585	145006**	22618	270 1/8"	693	125
307"	162" x 260"	145007	145007FB	145007FN	15183	145007**	24937	296 1/8"	734	125
<b>16:9 HDTV Format</b>										
184"	90" x 160"	145008	145008FB	145008FN	\$10969	145008**	\$14303	186 3/4"	575	125
193"	94 1/2" x 168"	145009	145009FB	145009FN	11546	145009**	15223	194 3/4"	580	125
220"	108" x 192"	145010	145010FB	145010FN	11816	145010**	16617	219 1/4"	620	125
227"	111" x 198"	145011	145011FB	145011FN	12106	145011**	17195	225 1/4"	625	125
248"	121 1/2" x 216"	145012	145012FB	145012FN	13336	145012**	19409	244 7/8"	651	125
270"	133" x 236"	145013	145013FB	145013FN	14353	145013**	21619	270 1/8"	682	125
300"	146" x 260"	145014	145014FB	145014FN	15183	145014**	23975	294 1/8"	725	125
<b>4:3 NTSC Video Format</b>										
200"	118" x 158"	145015	145015FB	145015FN	\$10969	145015**	\$15285	186 7/8"	580	125
210"	126" x 168"	145016	145016FB	145016FN	11546	145016**	16447	196 7/8"	595	125
220"	132" x 176"	145017	145017FB	145017FN	11826	145017**	17205	204 7/8"	600	125
230"	138" x 184"	145018	145018FB	145018FN	12106	145018**	17984	214 5/8"	615	125
240"	144" x 192"	145019	145019FB	145019FN	12236	145019**	18637	222 5/8"	643	125
250"	148" x 198"	145020	145020FB	145020FN	13336	145020**	20119	228 5/8"	654	125
270"	162" x 216"	145021	145021FB	145021FN	13439	145021**	21541	248 5/8"	682	125
24' 7"	177" x 236"	145022	145022FB	145022FN	15183	145022**	24857	274 1/4"	717	125
27' 6"	194" x 260"	145023	145023FB	145023FN	16648	145023**	28331	300 1/2"	767	125
<b>AV Format</b>										
10' 6" x 14'		145024	145024FB	145024FN	\$11546	--	--	196 7/8"	595	125
14' x 14'		145025	145025FB	145025FN	11892	--	--	202 3/4"	615	125
16' x 16'		145027	145027FB	145027FN	13149	--	--	229"	682	125
13' 6" x 18'		145028	145028FB	145028FN	13439	--	--	248 5/8"	684	125
18' x 18'		145029	145029FB	145029FN	14781	--	--	258 3/8"	725	125
15' x 20'		145030	145030FB	145030FN	15183	--	--	278 1/4"	732	125
11' x 22'		145031	145031FB	145031FN	15816	--	--	296 3/8"	748	125
16' 6" x 22'		145032	145032FB	145032FN	16648	--	--	306 3/8"	767	125

# Paragon V

The Paragon is a large, ceiling-recessed screen designed for auditoriums and lecture halls. Offered in both tab-tensioned, and self-supporting, it features a white extruded aluminum case. Operates on a 6" steel roller powered by an extremely strong tubular motor-in-roller. Plenum rated case (UL approved "Suitable for Use in Environmental Air Space"). Includes one 110-120V 3-position switch. **Paragon sizes with a case length of 300" or more require special handling. Request a freight estimate.**

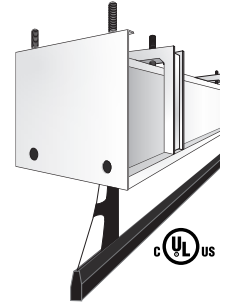

## STANDARD SPECS

- **Case Dimensions:** Case is 13 1/4" H x 12" D.
- **Black Borders:** Image area framed with black on all four sides. 12" black drop at top of viewing surface (standard).

## OPTIONS

- **Motor/Control Options:** 220V options available. See page 35.
- **Case Options:** All ceiling recessed cases can be painted black upon request at an additional cost.
- **Extra Drop:** Additional drop above image area: specify color of extra drop (surface color standard for AV; black for other formats). See page 36.

H x W/ Diagonal	Image Area	OptiFlex Viewing Surfaces			TecVision® Surfaces		Case Length	Ship Wt./lbs.	Freight Class
		Matt White XT1000VB	Pure White XT1300V	PRICE	TecVision®	PRICE			
<b>16:10 Format</b>									
234"	124" x 198"	114616	114616FN	\$6613	114616**	\$12296	220 1/4"	750	125
278"	147 1/2" x 236"	114617	114617FN	8972	114617**	17005	260"	850	125
307"	162" x 260"	114618	114618FN	9432	114618**	19186	286"	880	125
335"	177" x 284"	114619	114619FN	10699	114619**	22339	312 1/8"	1040	125
<b>16:9 HDTV Format</b>									
227"	111" x 198"	114612	114612FN	\$6613	114612**	\$11702	218 5/8"	759	125
270"	133" x 236"	114613	114613FN	8972	114613**	16238	260"	844	125
300"	146" x 260"	114614	114614FN	9432	114614**	18224	284"	957	125
324"	160" x 284"	114615	114615FN	10699	114615**	21218	310"	1040	125
<b>4:3 NTSC Video Format</b>									
250"	148" x 198"	114608	114608FN	\$6903	114608**	\$13686	222"	750	125
25'	177" x 236"	114609	114609FN	12147	114609**	21821	264 1/8"	820	125
27' 6"	194" x 260"	114610	114610FN	12733	114610**	24415	290 3/8"	880	125
30'	212" x 284"	114611	114611FN	14435	114611**	28379	316 1/4"	960	125
<b>AV Format</b>									
13' 6" x 18'		114600	114600FN	\$7276	114600**	--	242"	770	125
18' x 18'		114601	114601FN	13206	114601**	--	248 1/4"	796	125
15' x 20'		114602	114602FN	12237	114602**	--	268 1/8"	820	125
11' x 22'		114603	114603FN	12536	114603**	--	286 1/4"	880	125
16' 6" x 22'		114605	114605FN	12826	114605**	--	296 1/4"	925	125
12' x 24'		114606	114606FN	13711	114606**	--	312"	950	125
18' x 24'		114607	114607FN	14541	114607**	--	320 1/4"	1042	125

**Additional Paragon V Viewing Surfaces:** CineFlex CH1200V (CB) rear projection surface, and CineFlex White XT700V (CD) front/rear projection surface available by quotation—add the 2-letter suffix noted above to any Matt White XT1000VB part number. See pages 4-6.



\*\* To order a screen with a TecVision® surface, the suffix codes should be added to the end of the Matt White XT1000VB part number. (Ex. 114616TA for a 234" screen with the TecVision® CS1000X ALR surface.) See page 6 for full descriptions and formula codes of all available TecVision® surfaces.

## ACCESSORIES FOR PARAGON V

White Part No.	Black Part No.	PRICE	Ship Wt./lbs	Freight Class
<b>Wall Mounting Brackets (pr.)</b> —For wall installation. Includes hardware for attaching brackets to case.				
121204	121278	\$150	6	50 P
<b>Ceiling Trim Flange for Paragon endcaps (pr.)</b> —For endcaps. Includes hardware for attaching flanges to case.				
121205	121279	\$53	20	50 P
<b>Ceiling Trim Flange for Paragon case</b> —12' length of ceiling trim flange, with hardware for attaching it to case. Please divide length of case requiring trim (in feet) by 12 and round up to determine number of kits to order. Remember to order trim for both front and back of case if required.				
121206	121280	\$53	12	77.5 P+



## Tab-tensioned electric screen

Our most popular tab-tensioned electric screen. The Premier is housed in a black pentagonal steel case and utilizes a tubular motor-in-roller design. The Premier's endcaps are also its universal mounting brackets. Viewing surfaces from the TecVision®, OptiFlex, ClearSound, and CineFlex families.

### STANDARD SPECS

- **Sizes and Formats:** Custom sizes available by quotation. Custom sizes need to be specified in detail, including extra drop, if desired.
- **Case Dimensions:** Standard case is 5 7/8" H x 5 1/4" D, including endcaps with universal mounting brackets. Optional built-in controls and extra drop may increase case length: call Draper for dimensions.
- **Black Borders:** Image area fully framed with black; with 12" black drop at top of viewing surface is standard.

### OPTIONS

- **Motor/Control Options:** (Q) Quiet Motor, (U or L) Built-in Low-Voltage Controller and (P) Plug & Play™ available. See page 36 for details. 220V motor is also available at no extra cost.
- **Extra Drop:** Additional drop above image (black standard; surface color available on request). Extra drop will increase case length. See page 36.
- **Floating Screen Brackets** Optional wall/ceiling mounting brackets for added flexibility. For use with small case only. See page 18. **NOTE: Wall brackets ship standard. Floating Brackets MUST be specified at the time of order.**

- **Ceiling Opening Trim Kit:** Optional trim kit finishes opening for recessed installation in acoustical drop ceilings. See page 18.
- **Viewing Surface:** CineFlex CH1200V (CB) rear projection surface, and CineFlex White XT700V (CD) front/rear projection surface available by quotation—add the 2-letter suffix noted above to any Matt White XT1000VB part number. Also available with ClearSound Perf XT900V, a perforated matt white, in limited sizes by quotation—add the suffix SD to any Matt White XT1000VB part number. See page 5.



ELECTRIC SCREENS

**12" black drop as standard—NO EXTRA CHARGE! Please Note: Case length will increase by 2" for Premier with (U) Built-in Low-Voltage Controller LVC-IV.**

H x W / Diagonal	Image Area	OptiFlex Viewing Surfaces				Case Length	Ship Wt./lbs.	Dim Wt./lbs.	Freight Class	
		Matt White XT1000VB	PRICE	Grey XH600V	Pure White XT1300V					PRICE
<b>16:10 Format</b>										
76"	40" x 64"	101636	\$2220	101644	101636FN	\$2327	81"	59	66	125 P+
85"	45" x 72"	101637	2394	101645	101637FN	2511	89"	66	72	125 P+
94"	50" x 80"	101638	2472	101646	101638FN	2592	97"	74		125
109"	57 1/2" x 92"	101639	2537	101647	101639FN	2661	110"	73		125
113"	60" x 96"	101794	2607	101796	101794FN	2732	113 7/8"	80		125
123"	65" x 104"	101640	2817	101648	101640FN	2954	122"	85		125
137"	72 1/2" x 116"	101641	3036	101649	101641FN	3182	135"	91		125
165"	87 1/2" x 140"	101642	3501	101650	101642FN	3671	160 1/2"	105		125
<b>16:9 HDTV Format</b>										
73"	36" x 64"	101325	\$2220	101331	101325FN	\$2327	80"	59	66	125 P+
82"	40 1/2" x 72"	101326	2394	101332	101326FN	2511	89"	66	72	125 P+
92"	45" x 80"	101059	2472	101276	101059FN	2592	97 1/2"	69		125
100"	49" x 87"	101761	2506	101765	101761FN	2627	104"	70		125
106"	52" x 92"	101060	2537	101277	101060FN	2661	110"	74		125
110"	54" x 96"	101770	2607	101774	101770FN	2732	114"	76		125
119"	58" x 104"	101305	2817	101309	101305FN	2954	122"	88		125
133"	65" x 116"	101185	3036	101278	101185FN	3182	135"	91		125
161"	79" x 140"	101186	3501	101347	101186FN	3671	160 1/4"	111		125
<b>4:3 NTSC Video Format</b>										
7"	50" x 66 1/2"	101182	\$2225	101274	101182FN	\$2334	84 1/4"	59	70	125 P+
100"	60" x 80"	101056	2485	101275	101056FN	2607	97 3/4"	68		125
10'	72" x 96"	101058	2551	101271	101058FN	2674	115"	78		125
11'	78" x 104"	101183	2931	101345	101183FN	3074	124 1/4"	81		125
150"	87" x 116"	101184	3057	101346	101184FN	3206	136 1/4"	90		125
15'	108" x 144"	101179	3619	101373	101179FN	3796	165 3/4"	117		125
<b>AV Format</b>										
70" x 70"		101172	\$2352	101269	101172FN	\$2467	89"	60	75	125 P+
84" x 84"		101173	2579	101270	101173FN	2704	104 1/4"	65		125
96" x 96"		101174	2692	101272	101174FN	2822	117 3/4"	84		125
7' x 9'		101175	2851	101343	101175FN	2989	128 1/4"	87		125
9' x 9'		101176	3174	101344	101176FN	3329	129 3/4"	89		125
8' x 10'		101177	3302	101371	101177FN	3462	141 3/4"	93		125
10' x 10'		101178	3409	101372	101178FN	3574	143 1/2"	98		125
12' x 12'		101180	3994	101180FB	101180FN	4188	171 1/2"	122		125

CONTINUED



CHART

# Premier (Continued)

## ACCESSORIES FOR PREMIER—THESE ACCESSORIES ARE NOT COMPATIBLE WITH PREMIER XL.

**Ceiling Opening Trim Kit**—Designed for recessed installation in acoustical drop ceilings of Premier electric screens. Ships KD; assembles quickly with fasteners provided. Trims out the ceiling tile opening and attaches to screen endcaps. Painted white. Slot includes finished flange to accept acoustical ceiling tile or grid. Slot measures 2 1/8" in depth. Once installed, the finished slot length is equal to the Premier screen case length.

Finished Slot Length	Screen Case Length	Part No.	PRICE	Ship Wt./lbs.	Freight Class
102 1/2"	102 1/2" and shorter	121202	\$198	31	77.5
126 1/2"	102 1/2" – 126 1/2"	121203	217	36	77.5
174"	126 1/2" – 174"	121207	248	49	77.5

**Floating Screen Brackets**—Use Draper's Floating Screen Brackets for added flexibility and secure mounting of Premier even when available installation points are not located at the end of the case. Simply secure front and rear case brackets to screen case, attach wall/ceiling brackets to secure install points, then attach case brackets to wall/ceiling brackets. Available in black or white finish.

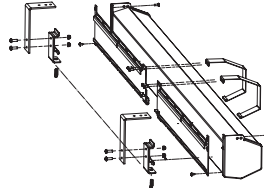

Floating Screen Brackets (pr.)	Part No.	PRICE	Shipping Wt./lbs.
White Finish	227025	\$100	11
Black Finish	227024	100	11

Non-Adjustable Wall Brackets	Part No.	PRICE	Shipping Wt./lbs.
6" Extension (white)	227212	\$26	2
6" Extension (black)	227213	26	2

**12" black drop as standard—NO EXTRA CHARGE!**

**Please Note: Case length will increase by 2" for Premier with (U) Built-in Low-Voltage Controller LVC-IV.**

H x W / Diagonal	Image Area	ClearSound Surface		TecVision® Viewing Surfaces				Case Length	Ship Wt./lbs.	Dim Wt./lbs.	Freight Class
		ClearSound NanoPerf XT1000V	PRICE	TecVision®	PRICE	TecVision® NanoPerf	PRICE				
<b>16:10 Format</b>											
76"	40" x 64"	101636SC	\$2719	101636**	\$2812	101636**	\$3311	81"	59	66	125 P+
85"	45" x 72"	101637SC	2901	101637**	3144	101637**	3651	89"	66	73	125 P+
94"	50" x 80"	101638SC	2984	101638**	3399	101638**	3911	97"	69		125
109"	57 1/2" x 92"	101639SC	3052	101639**	3762	101639**	4278	110"	74		125
113"	60" x 96"	101794SC	3127	101794**	3941	101794**	4461	113 7/8"	80		125
123"	65" x 104"	101640SC	3346	101640**	4384	101640**	4913	122"	85		125
137"	72 1/2" x 116"	101641SC	3574	101641**	4983	101641**	5521	135"	91		125
165"	87 1/2" x 140"	101642SC	4064	101642**	6336	101642**	6900	160 1/2"	105		125
<b>16:9 HDTV Format</b>											
73"	36" x 64"	101325SC	\$2719	101325**	\$2754	101325**	\$3252	80"	59	66	125 P+
82"	40 1/2" x 72"	101326SC	2901	101326**	3071	101326**	3577	89"	66	73	125 P+
92"	45" x 80"	101059SC	2984	101059**	3306	101059**	3817	97 1/2"	69		125
100"	49" x 87"	101761SC	3017	101761**	3492	101761**	4004	104"	70		125
106"	52" x 92"	101060SC	3052	101060**	3644	101060**	4159	110"	74		125
110"	54" x 96"	101770SC	3124	101770**	3807	101770**	4324	114"	76		125
119"	58" x 104"	101305SC	3346	101305**	4214	101305**	4743	122"	88		125
133"	65" x 116"	101185SC	3574	101185**	4783	101185**	5321	135"	92		125
161"	79" x 140"	101186SC	4064	101186**	6061	101186**	6625	160 1/4"	111		125
<b>4:3 NTSC Video Format</b>											
7'	50" x 66 1/2"	101182SC	\$2724	101182**	\$2996	101182**	\$3494	84 1/4"	59	71	125 P+
100"	60" x 80"	101056SC	2999	101056**	3597	101056**	4111	97 3/4"	68		125
10'	72" x 96"	101058SC	3064	101058**	4151	101058**	4664	115"	76		125
11'	78" x 104"	101183SC	3464	101183**	4809	101183**	5343	124 1/4"	81		125
150"	87" x 116"	101184SC	3597	101184**	5394	101184**	5935	136 1/4"	90		125
15'	108" x 144"	--	--	101179**	7220	--	--	165 3/4"	117		125
<b>AV Format</b>											
70" x 70"		101172SC	\$2857	--	--	--	--	89"	60	75	125 P+
84" x 84"		101173SC	3096	--	--	--	--	104 1/4"	65		125
96" x 96"		101174SC	3214	--	--	--	--	117 3/4"	84		125
7' x 9'		101175SC	3381	--	--	--	--	128 1/4"	87		125
9' x 9'		--	--	--	--	--	--	129 3/4"	89		125
8' x 10'		101177SC	3854	--	--	--	--	141 3/4"	93		125
10' x 10'		--	--	--	--	--	--	143 1/2"	98		125
12' x 12'		--	--	--	--	--	--	171 1/2"	122		125

**TECVISION** \*\* To order a screen with a TecVision® surface, the suffix codes should be added to the end of the Matt White XT1000VB part number. (Ex. 101635TA for a 67" screen with the TecVision® CS1000X ALR surface.) See page 6 for full descriptions and formula codes of all available TecVision® surfaces.

# Premier XL

ELECTRIC SCREENS  
WALL/CEILING MOUNTED

## Larger version of the popular Premier Tab-tensioned electric screen

The Premier XL is housed in a black aluminum case and utilizes a tubular motor-in-roller design. The Premier XL's endcaps are also its universal mounting brackets. Viewing surfaces from the OptiFlex, ClearSound, CineFlex, and TecVision® families.

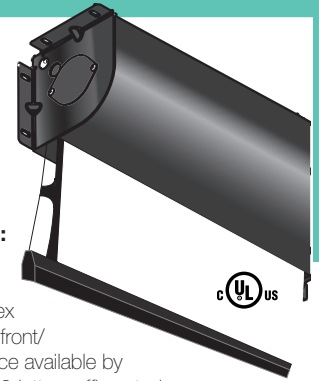

ELECTRIC SCREENS

### STANDARD SPECS

- **Sizes and Formats:** Custom sizes available by quotation. Custom sizes need to be specified in detail, including extra drop, if desired.
- **Case Dimensions:** Standard case is 6 3/4" H x 6 3/4" D, including endcaps with universal mounting brackets. Optional built-in controls and extra drop may increase case length: call Draper for dimensions.
- **Black Borders:** Image area fully framed with black; with 12" black drop at top of viewing surface is standard.

### OPTIONS

- **Motor/Control Options:** (U or L) Built-in Low-Voltage Controller, and (LP) Low-Voltage Controller with Plug & Play™ **\$179 NET** available. See page 36 for details. 220V motor is also available at no extra cost.
- **Extra Drop:** Additional drop above image (black standard; surface color available on request). Extra drop will increase case length. See page 36.

- **Viewing Surface:** CineFlex CH1200V (CB) rear projection surface, and CineFlex White XT700V (CD) front/rear projection surface available by quotation—add the 2-letter suffix noted above to any Matt White XT1000VB part number. Also available with ClearSound Perf XT900V, a perforated matt white, in limited sizes by quotation—add the suffix SD to any Matt White XT1000VB part number. See page 5.

**12" black drop as standard—NO EXTRA CHARGE! Please Note: Case length will increase by 2" for Premier with (U) Built-in Low-Voltage Controller LVC-IV. Not compatible with 6" Extension Brackets, Floating Brackets, Ceiling Opening Trim Kit, or optional Q and QL motors.**

H x W / Diagonal	Image Area	OptiFlex Viewing Surfaces				Case Length	Ship Wt./lbs.	Freight Class
		Matt White XT1000VB	Grey XH600V	Pure White XT1300V	PRICE			
<b>16:10 Format</b>								
189"	100" x 160"	101804	101805	101804FN	\$3836	183 1/8"	415	125
198"	105" x 168"	101779	101781	101779FN	4394	191 5/8"	428	125
226"	120" x 192"	101782	101784	101782FN	5006	217 1/4"	441	125
<b>16:9 HDTV Format</b>								
184"	90" x 160"	101800	101801	101800FN	\$3836	183 1/8"	410	125
193"	94 1/2" x 168"	101689	101690	101689FN	4394	191 1/8"	428	125
220"	108" x 192"	101391	101393	101391FN	5006	215 5/8"	439	125
<b>4:3 NTSC Video Format</b>								
200"	118" x 158"	101808	101809	101808FN	\$3836	183 1/4"	410	125
210"	126" x 168"	101686	101687	101686FN	4394	193 1/4"	393	125
220"	132" x 176"	101385	101385FB	101385FN	4553	201 1/4"	437	125
230"	138" x 184"	101386	101386FB	101386FN	4826	211"	452	125
20'	144" x 192"	101387	101387FB	101387FN	5119	219"	429	125
<b>AV Format</b>								
14' x 14'		101381	101381FB	101381FN	\$4513	199 1/8"	413	125
12' x 16'		101382	101382FB	101382FN	5196	219"	481	125

H x W / Diagonal	Image Area	ClearSound Surface		TecVision® Viewing Surfaces				Case Length	Ship Wt./lbs.	Freight Class
		ClearSound NanoPerf XT1000V	PRICE	TecVision®	PRICE	TecVision® NanoPerf	PRICE			
<b>16:10 Format</b>										
189"	100" x 160"	101804SC	\$4211	101804**	\$7538	--	--	183 1/8"	415	125
198"	105" x 168"	--	--	101779**	8478	--	--	191 5/8"	428	125
226"	120" x 192"	--	--	101782**	10340	--	--	217 1/4"	441	125
<b>16:9 HDTV Format</b>										
184"	90" x 160"	101800SC	\$4211	101800**	\$7170	101800**	\$7545	183 1/8"	410	125
193"	94 1/2" x 168"	101689SC	4766	101689**	8072	--	--	191 1/8"	428	125
220"	108" x 192"	--	--	101391**	9807	--	--	215 5/8"	439	125
<b>4:3 NTSC Video Format</b>										
200"	118" x 158"	--	--	101808**	\$8152	--	--	183 1/4"	410	125
210"	126" x 168"	--	--	101686**	9295	--	--	193 1/4"	393	125
220"	132" x 176"	--	--	101385**	9932	--	--	201 1/4"	437	125
230"	138" x 184"	--	--	101386**	10704	--	--	211"	452	125
20'	144" x 192"	--	--	101387**	11521	--	--	219"	429	125

**TECVISION®** \*\* To order a screen with a TecVision® surface, the suffix codes should be added to the end of the Matt White XT1000VB part number. (Ex. 101804TA for a 189" screen with the TecVision® CS1000X ALR surface.) See page 10 for full descriptions and formula codes of all available TecVision® surfaces.

# Silhouette V

## Tab-tensioned electric screen

Tab-tensioned screen for wall/ceiling installation, with streamlined extruded white aluminum case. No exposed fasteners or mounting fixtures. Includes one 110-120v 3-position switch. Viewing surfaces from the OptiFlex, ClearSound, CineFlex, and TecVision® families.



### STANDARD SPECS

- **Sizes and Formats:** Custom sizes available by quotation. Custom sizes need to be specified in detail, including extra drop, if desired.
- **Case Dimensions:** 6" H x 4 3/4" D. Optional built-in controls and extra drop may increase case length; call Draper for dimensions.
- **Black Borders:** Image area fully framed with black; with 12" black drop at top of viewing surface is standard.

### OPTIONS

- **Motor/Control Options:** (Q) Quiet Motor, (U or L) Built-in Low-Voltage Controller (Adds to case length), and (P) Plug & Play™ available. See page 36 for details. 220V motor is also available at no extra cost.
- **Extra Drop:** Additional drop above image (black standard; surface color available on request). Extra drop will increase case length. See page 36.
- **Finish Options:** White or Black case finish available at no extra charge.
- **Viewing Surface:** CineFlex CH1200V (CB) rear projection surface, and CineFlex White XT700V (CD) front/rear projection surface available by quotation—add the 2-letter suffix noted above to any Matt White XT1000VB part number. Also available with ClearSound Perf XT900V, a perforated matt white, in limited sizes by quotation—add the suffix SD to any Matt White XT1000VB part number. See page 5.

H x W / Diagonal	Image Area	OptiFlex Viewing Surfaces				ClearSound Surface		Case Length	Ship Wt./lbs.	Dim Wt./lbs.	Freight Class
		Matt White XT1000VB	Grey XH600V	Pure White XT1300V	PRICE	ClearSound NanoPerf XT1000V	PRICE				
<b>16:10 Format</b>											
76"	40" x 64"	107338	107343	107338FN	\$2589	107338SC	\$2982	85 3/4"	56	64	125 P+
85"	45" x 72"	107339	107344	107339FN	2774	107339SC	3147	93 3/4"	62	69	125 P+
94"	50" x 80"	107340	107345	107340FN	2892	107340SC	3264	101 3/4"	68		125
109"	57 1/2" x 92"	107341	107346	107341FN	2964	107341SC	3337	114 3/4"	83		125
113"	60" x 96"	107403	107405	107403FN	2982	107403SC	3356	118 5/8"	83		125
<b>16:9 HDTV Format</b>											
73"	36" x 64"	107320	107326	107320FN	\$2589	107320SC	\$2962	84 3/4"	55	64	125 P+
82"	40 1/2" x 72"	107321	107327	107321FN	2774	107321SC	3147	93 3/4"	62	69	125 P+
92"	45" x 80"	107250	107302	107250FN	2892	107250SC	3264	102 3/4"	66		125
100"	49" x 87"	107397	107401	107397FN	2926	107397SC	3299	108 3/4"	70		125
106"	52" x 92"	107251	107303	107251FN	2964	107251SC	3337	114 3/4"	80		125
110"	54" x 96"	107409	107411	107409FN	2982	107409SC	3356	118 5/8"	90		125
<b>4:3 NTSC Video Format</b>											
7'	50" x 66 1/2"	107248	107300	107248FN	\$2592	107248SC	\$2966	89 1/4"	59	65	125 P+
100"	60" x 80"	107249	107301	107249FN	2887	107249SC	3261	103 3/4"	70		125
10'	72" x 96"	107245	107297	107245FN	2961	107245SC	3332	119 3/4"	75		125
<b>AV Format</b>											
70" x 70"		107243	107295	107243FN	\$2732	107243SC	\$3104	93 3/4"	62	68	125 P+
84" x 84"		107244	107296	107244FN	2984	107244SC	3357	109"	70		125
96" x 96"		107246	107298	107246FN	3106	107246SC	3481	122 1/2"	82		125

**TECVISION®** \*\* To order a screen with a TecVision® surface, the suffix codes should be added to the end of the Matt White XT1000VB part number.

(Ex. 107337TA for a 67" screen with the TecVision® CS1000X ALR surface.)

See page 6 for full descriptions and formula codes of all available TecVision® surfaces.

CHART CONTINUED BELOW



H x W / Diagonal	Image Area	TecVision® Viewing Surfaces				Case Length	Ship Wt./lbs.	Dim Wt./lbs.	Freight Class
		TecVision®	PRICE	TecVision® NanoPerf	PRICE				
<b>16:10 Format</b>									
76"	40" x 64"	107338**	\$3181	107338**	\$3574	85 3/4"	56	64	125 P+
85"	45" x 72"	107339**	3524	107339**	3897	93 3/4"	62	69	125 P+
94"	50" x 80"	107340**	3819	107340**	4191	101 3/4"	68		125
109"	57 1/2" x 92"	107341**	4189	107341**	4563	114 3/4"	83		125
113"	60" x 96"	107403**	4316	107403**	4689	118 5/8"	83		125
<b>16:9 HDTV Format</b>									
73"	36" x 64"	107320**	\$3122	107320**	\$3496	84 3/4"	55	64	125 P+
82"	40 1/2" x 72"	107321**	3451	107321**	3824	93 3/4"	62	69	125 P+
92"	45" x 80"	107250**	3726	107250**	4097	102 3/4"	66		125
100"	49" x 87"	107397**	3912	107397**	4286	108 3/4"	70		125
106"	52" x 92"	107251**	4071	107251**	4444	114 3/4"	80		125
110"	54" x 96"	107409**	4183	107409**	4556	118 5/8"	75		125
<b>4:3 NTSC Video Format</b>									
7'	50" x 66 1/2"	107248**	\$3362	107248**	\$3736	89 1/4"	59	65	125 P+
100"	60" x 80"	107249**	3999	107249**	4373	103 3/4"	70		125
10'	72" x 96"	107245**	4561	107245**	4933	119 3/4"	75		125

## Self-supporting, ceiling-recessed electric screen.

Motor-in-roller electric screen for ceiling-recessed installation. The hinged door cover makes installation and service easier. White finished case. "Plug-in" wiring connections allow installation of case early and screen later. Plenum rated case (UL approved "Suitable for Use in Environmental Air Space"). Includes one 110-120v 3-position switch. An Access case may be ordered and installed prior to selecting a screen size, type and format. Note: for alternate installation of Access screens, additional set of brackets is required. Part no. C502.240

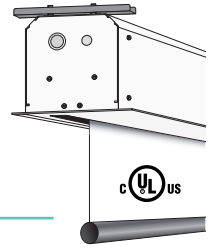

ELECTRIC SCREENS

### STANDARD SPECS

- **Sizes and Formats:** Custom sizes by quotation. Custom sizes need to be specified in detail, including extra drop, if desired.
- **Case Dimensions:** Case Dimensions 7 3/8" high x 8 1/16" deep including trim flange. Mounting brackets may add to both dimensions, see Submittal in the Technical Documents tab at [www.draperinc.com](http://www.draperinc.com) for details.
- **Black Borders:** NTSC, HDTV, and 16:10 format have image area framed with black on all four sides. Black side borders are available on request for AV format screens.

### OPTIONS

- **Motor/Control Options:** Quiet Motor (Q), or Built-in Low-Voltage Controller (U or L) available. See page 35 for details. 220V motor is also available at no extra cost.
- **Case Options:** For more information on how to order case in advance of screen, see page 10. Black case available on request at \$15 charge per lineal ft.
- **Extra Drop:** Additional drop above image area (specify color—surface color standard for AV format; black standard for all others). See page 36.

H x W / Diagonal	Image Area	Overall Size	OptiFlex Viewing Surfaces			ClearSound Viewing Surfaces			Case Length	Ship Wt./lbs.	Freight Class
			Matt White XT1000E	Contrast Grey XH800E	PRICE	ClearSound White Weave XT900E	ClearSound Grey Weave XH600E	PRICE			
<b>16:10 Format</b>											
94"	50" x 80"	62" x 83 1/2"	139113	139113EC	\$2739	139113SA	139113SB	\$5478	97 3/4"	107	125
109"	57 1/2" x 92"	69 1/2" x 96"	139114	139114EC	2774	139114SA	139114SB	5549	109 3/4"	113	125
113"	60" x 96"	72" x 100"	139115	139115EC	2804	139115SA	139115SB	5608	113 3/4"	117	125
123"	65" x 104"	69" x 108"	139116	139116EC	2814	139116SA	139116SB	5628	121 3/4"	121	125
137"	72 1/2" x 116"	76 1/2" x 120"	139117	139117EC	2849	139117SA	139117SB	5698	133 3/4"	129	125
165"	87 1/2" x 140"	92 1/2" x 144"	139042	139042EC	2859	139042SA	139042SB	5718	157 3/4"	153	125
189"	100" x 160"	105" x 164"	139043	139043EC	2927	139043SA	139043SB	5855	177 3/4"	172	125
198"	105" x 168"	110" x 172"	139044	139044EC	7777	139044SA	139044SB	15553	185 3/4"	285	125
222"	117 1/2" x 188"	122 1/2" x 192"	139045	139045EC	8075	--	--	--	205 3/4"	378	125
<b>16:9 HDTV Format</b>											
92"	45" x 80"	57" x 83 1/2"	139107	139107EC	\$2739	139107SA	139107SB	\$5478	97 3/4"	106	125
100"	49" x 87"	61" x 91"	139108	139108EC	2759	139108SA	139108SB	5518	104 3/4"	107	125
106"	52" x 92"	64" x 96"	139109	139109EC	2774	139109SA	139109SB	5549	109 3/4"	111	125
110"	54" x 96"	66" x 100"	139110	139110EC	2804	139110SA	139110SB	5608	113 3/4"	116	125
119"	58" x 104"	62" x 108"	139111	139111EC	2814	139111SA	139111SB	5628	121 3/4"	120	125
133"	65" x 116"	69" x 120"	139112	139112EC	2849	139112SA	139112SB	5698	133 3/4"	129	125
161"	79" x 140"	84" x 144"	139033	139033EC	2859	139033SA	139033SB	5718	157 3/4"	148	125
184"	90" x 160"	95" x 164"	139034	139034EC	2927	139034SA	139034SB	5855	177 3/4"	169	125
193"	94 1/2" x 168"	99 1/2" x 172"	139035	139035EC	7777	139035SA	139035SB	15553	185 3/4"	297	125
220"	106" x 188"	111" x 192"	139036	139036EC	8075	139036SA	139036SB	16150	205 3/4"	328	125
<b>4:3 NTSC Video Format</b>											
7'	50" x 66 1/2"	53 1/2" x 69 1/2"	139102	139102EC	\$2662	139102SA	139102SB	\$5323	83 1/4"	103	125
100"	60" x 80"	64" x 83 1/2"	139103	139103EC	2671	139103SA	139103SB	5339	97 3/4"	113	125
10'	69" x 92"	73" x 96"	139104	139104EC	2727	139104SA	139104SB	5453	109 3/4"	107	125
11'	78" x 104"	83" x 108"	139105	139105EC	2791	139105SA	139105SB	5581	121 3/4"	125	125
150"	87" x 116"	92" x 120"	139106	139106EC	2814	139106SA	139106SB	5628	133 3/4"	130	125
15'	105" x 140"	109" x 144"	139022	139022EC	2914	139022SA	139022SB	5828	157 3/4"	154	125
200"	118" x 158"	123" x 162"	139023	139023EC	2982	--	--	--	175 3/4"	210	125
210"	126" x 168"	131" x 172"	139024	139024EC	7777	--	--	--	185 3/4"	250	125
220"	132" x 176"	137" x 180"	139025	139025EC	7988	--	--	--	193 3/4"	278	125
240"	141" x 188"	146" x 192"	139026	139026EC	8075	--	--	--	205 3/4"	378	125
<b>AV Format</b>											
9' x 12'			139011	139011EC	\$3122	139011SA	139011SB	\$6243	157 3/4"	159	125
12' x 12'			139012	139012EC	3401	--	--	--	157 3/4"	142	125
10' 6" x 14"			139013	139013EC	7893	--	--	--	181 3/4"	200	125
14' x 14'			139014	139014EC	8372	--	--	--	181 3/4"	210	125
12' x 16'			139015	139015EC	8193	--	--	--	205 3/4"	278	125

# Access FIT E

## Slim, Self-supporting, ceiling-recessed electric screen

The Access FIT E features a lower-profile case to fit in smaller spaces. The hinged door cover makes installation and service easier. Access FIT E is motor-in-roller for ceiling-recessed installation. White finished case. "Plug-in" wiring connections allow installation of case early and screen later. Plenum rated case (UL approved "Suitable for Use in Environmental Air Space"). Includes one 110-120v 3-position switch.

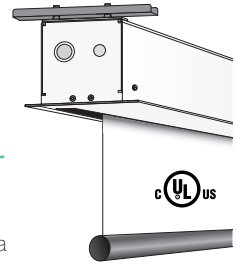

### STANDARD SPECS

- Sizes and Formats:** Custom sizes by quotation. Custom sizes need to be specified in detail, including extra drop, if desired.
- Case Dimensions:** Case Dimensions 5 11/16" high x 6 7/16" deep including trim flange. Mounting brackets may add to both dimensions, see Submittal in the Technical Documents tab at [www.draperinc.com](http://www.draperinc.com) for details.
- Black Borders:** NTSC, HDTV, and 16:10 format have image area framed with black on all four sides. Black side borders are available on request for AV format screens.

### OPTIONS

- Motor/Control Options:** Quiet Motor (Q), or Built-in Low-Voltage Controller (U or L) available. See page 36 for details. 220V motor is also available at no extra cost.
- Case Options:** An Access case may be ordered and installed prior to selecting a screen. For more information on how to order case in advance of screen, see page 10. Black case available on request at \$15 charge per lineal ft.
- Extra Drop:** Additional drop above image area (specify color—surface color standard for AV format; black standard for all others). See page 36.

\*These sizes include 12" black drop as standard—NO EXTRA CHARGE! For alternate installation, additional brackets required. Part No. C502.233 \$12 NET.

H x W / Diagonal	Image Area	Overall Size	OptiView Surfaces					ClearSound Viewing Sur-			Case Length	Ship Wt./lbs.	Freight Class	
			Matt White XT1000E	Contrast Grey XH800E	Contrast White XH1100E	Argent White XH1500E	Pearl White CH1900E	PRICE	ClearSound White Weave XT900E	ClearSound Grey Weave XH600E				PRICE
<b>16:10 Format</b>														
94"	50" x 80"	62" x 83 1/2"	139037	139037EC	139037EG	139037EH	139037EJ	\$2652	139037SA	139037SB	\$6105	99 1/2"	87	125
109"	57 1/2" x 92"	69 1/2" x 96"	139038	139038EC	139038EG	139038EH	139038EJ	2689	139038SA	139038SB	6183	111 1/2"	93	125
113"	60" x 96"	72" x 100"	139039	139039EC	139039EG	139039EH	139039EJ	2717	139039SA	139039SB	6248	115 1/2"	97	125
123"	65" x 104"	69" x 108"	139040	139040EC	139040EG	139040EH	--	2729	139040SA	139040SB	6275	123 1/2"	101	125
137"	72 1/2" x 116"	76 1/2" x 120"	139041	139041EC	139041EG	139041EH	--	2762	139041SA	139041SB	6355	135 1/2"	109	125
<b>16:9 HDTV Format</b>														
92"	45" x 80"	57" x 83 1/2"	139027	139027EC	139027EG	139027EH	139027EJ	\$2652	139027SA	139027SB	\$5814	99 1/2"	86	125
100"	49" x 87"	61" x 91"	139028	139028EC	139028EG	139028EH	139028EJ	2674	139028SA	139028SB	7471	106 1/2"	87	125
106"	52" x 92"	64" x 96"	139029	139029EC	139029EG	139029EH	139029EJ	2689	139029SA	139029SB	7767	111 1/2"	91	125
110"	54" x 96"	66" x 100"	139030	139030EC	139030EG	139030EH	--	2717	139030SA	139030SB	7885	115 1/2"	96	125
119"	58" x 104"	62" x 108"	139031	139031EC	139031EG	139031EH	--	2729	139031SA	139031SB	7950	123 1/2"	100	125
133"	65" x 116"	69" x 120"	139032	139032EC	139032EG	139032EH	--	2762	139032SA	139032SB	8147	135 1/2"	109	125
<b>4:3 NTSC Video Format</b>														
7"	50" x 66 1/2"	53 1/2" x 69 1/2"	139017	139017EC	139017EG	139017EH	139017EJ	\$2609	139017SA	139017SB	\$5998	85"	83	125 P+
100"	60" x 80"	64" x 83 1/2"	139018	139018EC	139018EG	139018EH	139018EJ	2671	139018SA	139018SB	6140	99 1/2"	93	125
10'	69" x 92"	73" x 96"	139019	139019EC	139019EG	139019EH	139019EJ	2727	139019SA	139019SB	7895	111 1/2"	87	125
11'	78" x 104"	83" x 108"	139020	139020EC	139020EG	139020EH	--	2791	139020SA	139020SB	8232	123 1/2"	105	125
150"	87" x 116"	92" x 120"	139021	139021EC	139021EG	139021EH	--	2814	139021SA	139021SB	8277	135 1/2"	110	125
<b>AV Format</b>														
70" x 70"			139003	139003EC	139003EG	139003EH	139003EJ	\$2627	139003SA	139003SB	\$6045	85"	74	125 P+
84" x 84"			139004	139004EC	139004EG	139004EH	139004EJ	2699	139004SA	139004SB	6206	99 1/2"	88	125
72" x 96"			139005	139005EC	139005EG	139005EH	139005EJ	2726	139005SA	139005SB	6270	111 1/2"	93	125
96" x 96"			139006	139006EC	139006EG	139006EH	139006EJ	2781	139006SA	139006SB	6393	111 1/2"	95	125
7' x 9'			139007	139007EC	139007EG	139007EH	--	2854	139007SA	139007SB	6563	123 1/2"	95	125
9' x 9'			139008	139008EC	139008EG	139008EH	--	2906	--	--	--	123 1/2"	95	125
8' x 10'			139009	139009EC	139009EG	139009EH	--	2949	139009SA	139009SB	6778	135 1/2"	111	125
10' x 10'			139010	139010EC	139010EG	139010EH	--	3002	--	--	--	135 1/2"	104	125

# Access XL E

## XL Self-supporting, ceiling-recessed electric screen.

The Access XL E line of projection screens are electric, ceiling-recessed, and offer the same great features as other Access screens—in a range of large sizes. Includes one 110-120v 3-position switch. Viewing surfaces available from the OptiView family. Case lengths below include flange to support ceiling tile or trim ceiling opening. Plenum rated case (UL approved "Suitable for Use in Environmental Air Space"). Note: for alternate installation of Access screens, additional set of brackets is required. Part No. C502.281

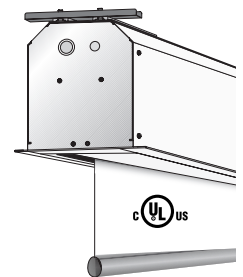

### STANDARD SPECS

- Sizes and Formats:** Custom sizes by quotation. Custom sizes need to be specified in detail, including extra drop, if desired.
- Case Dimensions:** Case Dimensions 10 1/8" high x 9 7/16" deep including trim flange. Mounting brackets may add to both dimensions, see Submittal at [www.draperinc.com](http://www.draperinc.com) for details.
- Black Borders:** NTSC, HDTV, and 16:10 format have image area framed with black on all four sides. Black side borders are available on request for AV format screens.

### OPTIONS

- Motor/Control Options:** Built-in Low-Voltage Controller (U or L) available. See page 35 for details. 220V motor is also available at no extra cost.
- Case Options:** Black case available on request at \$15 charge per lineal ft.
- Extra Drop:** Additional drop above image area (specify color—surface color standard for AV format; black standard for all others). See page 36.

H x W / Diagonal	Image Area	Overall Size	OptiView Sur-		Case Length	Ship Wt.	Freight Class
			Matt White XT1000E	PRICE			
<b>16:10 Format</b>							
255"	135" x 216"	140" x 220"	146012	\$9404	233 3/4"	500	125
278"	147 1/2" x 236"	152 1/2" x 240"	146013	9924	253 3/4"	585	125
<b>16:9 HDTV Format</b>							
248"	121 1/2" x 216"	126 1/2" x 220"	146010	\$9404	233 3/4"	500	125
270"	133" x 236"	138 1/2" x 240"	146011	9924	253 3/4"	542	125
<b>4:3 NTSC Video Format</b>							
250"	148" x 198"	153" x 202"	146007	\$8882	215 3/4"	450	125
270"	162" x 216"	167" x 220"	146008	9509	233 3/4"	542	125
295"	177" x 236"	182" x 240"	146009	10032	253 3/4"	565	125
<b>AV Format</b>							
16' x 16'			146001	\$9162	205 3/4"	425	125
13' 6" x 18'			146002	9627	229 3/4"	450	125
18' x 18'			146003	9757	229 3/4"	450	125
8' x 20'			146004	10045	253 3/4"	542	125
15' x 20'			146005	10204	253 3/4"	542	125
20' x 20'			146006	11002	253 3/4"	542	125

# Ultimate Access E

**ELECTRIC SCREENS**  
CEILING-RECESSED

## Self-supporting electric screen with motorized closure

Motor-in-roller electric screen for ceiling-recessed installation. White finished folded steel case with "plug-in" wiring connections that enable installation of case early in construction, and viewing surface later. No exposed fasteners. Independently motorized ceiling closure opens into the case. Plenum rated case (UL approved "Suitable for Use in Environmental Air Space"). Includes one 110-120v 3-position switch. Left hand motor location only. Viewing surfaces available from the OptiView, ClearSound, and TecVision® families. An Ultimate Access case may be ordered and installed prior to selecting a screen size, type and format. See page 10 for cases.

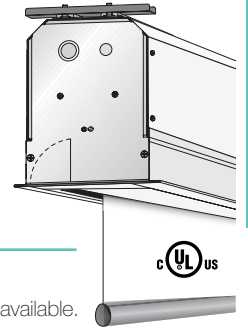

ELECTRIC SCREENS

### STANDARD SPECS

- **Sizes and Formats:** Custom sizes by quotation. Custom sizes need to be specified in detail, including extra drop, if desired.
- **Case Dimensions:** Case Dimensions 9 7/8" high x 8" deep including trim flange. Mounting brackets may add to both dimensions, see Submittal in the Technical Documents tab at [www.draperinc.com](http://www.draperinc.com) for details. Built in controls may increase length of case; call Draper for dimensions.
- **Black Borders:** NTSC, HDTV, and 16:10 format have image area framed with black on all four sides. Black side borders are available on request for AV format screens.

### OPTIONS

- **Motor/Control Options:** Quiet Motor (Q), or Built-in Low-Voltage Controller (U) available. See page 36 for details. 220V motor is also available at no extra cost.
- **Case Options:** For more information on how to order case in advance of screen, see page 10. Black case available on request at \$15 charge per lineal ft.
- **Extra Drop:** Additional drop above image (specify color— surface color standard for AV format; black standard for all others). See page 5.

**\*These sizes include 12" black drop as standard—NO EXTRA CHARGE!**

H x W / Diagonal	Image Area	Overall Size	OptiView Viewing Surfaces					ClearSound Viewing Sur-			Case Length	Ship Wt.	Freight Class	
			Matt White XT1000E	Contrast Grey XH800E	Contrast White XH1100E	Argent White XH1500E	Pearl White CH1900E	PRICE	ClearSound White Weave XT900E	ClearSound Grey Weave XH600E				PRICE
<b>16:10 Format</b>														
94"	50" x 80"	62" x 83 1/2"	142027	142027EC	142027EG	142027EH	142027EJ	\$3901	142027SA	142027SB	\$8293	99"	114	125
109"	57 1/2" x 92"	69 1/2" x 96"	142028	142028EC	142028EG	142028EH	142028EJ	3932	142028SA	142028SB	9097	111"	120	125
113"	60" x 96"	72" x 100"	142029	142029EC	142029EG	142029EH	--	4067	142029SA	142029SB	9899	115"	123	125
123"	65" x 104"	69" x 108"	142030	142030EC	142030EG	142030EH	--	4077	142030SA	142030SB	10662	123"	132	125
137"	72 1/2" x 116"	76 1/2" x 120"	142031	142031EC	142031EG	142031EH	--	4214	142031SA	142031SB	11587	135"	139	125
165"	87 1/2" x 140"	92 1/2" x 144"	142032	142032EC	--	--	--	4306	142032SA	142032SB	11841	159"	202	125
<b>16:9 HDTV Format</b>														
92"	45" x 80"	57" x 83 1/2"	142020	142020EC	142020EG	142020EH	142020EJ	\$3901	142020SA	142020SB	\$8293	99"	110	125
100"	49" x 87"	61" x 91"	142021	142021EC	142021EG	142021EH	142021EJ	3912	142021SA	142021SB	8692	106"	116	125
106"	52" x 92"	64" x 96"	142022	142022EC	142022EG	142022EH	142022EJ	3932	142022SA	142022SB	9899	111"	119	125
110"	54" x 96"	66" x 100"	142023	142023EC	142023EG	142023EH	--	4067	142023SA	142023SB	10417	115"	125	125
119"	58" x 104"	62" x 108"	142024	142024EC	142024EG	142024EH	--	4077	142024SA	142024SB	10662	123"	130	125
133"	65" x 116"	69" x 120"	142025	142025EC	142025EG	142025EH	--	4214	142025SA	142025SB	11587	135"	174	125
161"	79" x 140"	84" x 144"	142026	142026EC	--	--	--	4306	142026SA	142026SB	11841	159"	169	125
<b>4:3 NTSC Video Format</b>														
7'	50" x 66 1/2"	53 1/2" x 69 1/2"	142014	142014EC	142014EG	142014EH	142014EJ	\$3912	142014SA	142014SB	\$8122	85"	102	125
100"	60" x 80"	64" x 83 1/2"	142015	142015EC	142015EG	142015EH	142015EJ	3932	142015SA	142015SB	8740	99"	112	125
10'	69" x 92"	73" x 96"	142016	142016EC	142016EG	142016EH	142016EJ	4067	142016SA	142016SB	11022	111"	119	125
11'	78" x 104"	83" x 108"	142017	142017EC	142017EG	142017EH	--	4077	142017SA	142017SB	11551	123"	130	125
150"	87" x 116"	92" x 120"	142018	142018EC	142018EG	142018EH	--	4214	142018SA	142018SB	11841	135"	143	125
15'	105" x 140"	109" x 144"	142019	142019EC	--	--	--	4306	142019SA	142019SB	12366	159"	182	125
<b>AV Format</b>														
70" x 70"			142003	142003EC	142003EG	142003EH	142003EJ	\$3906	142003SA	142003SB	\$8202	85"	102	125
84" x 84"			142004	142004EC	142004EG	142004EH	142004EJ	4021	142004SA	142004SB	8825	99"	118	125
72" x 96"			142005	142005EC	142005EG	142005EH	142005EJ	4051	142005SA	142005SB	11129	111"	138	125
96" x 96"			142006	142006EC	142006EG	142006EH	142006EJ	4116	142006SA	142006SB	11396	111"	147	125
7' x 9'			142007	142007EC	142007EG	142007EH	--	4236	142007SA	142007SB	11664	123"	150	125
9' x 9'			142008	142008EC	--	--	--	4276	142008SA	142008SB	11811	123"	152	125
8' x 10'			142009	142009EC	142009EG	142009EH	--	4363	142009SA	142009SB	11957	135"	161	125
10' x 10'			142010	142010EC	--	--	--	4439	--	--	--	135"	167	125
9' x 12'			142011	142011EC	--	--	--	4461	--	--	--	159"	172	125
12' x 12'			142012	142012EC	--	--	--	4618	--	--	--	159"	182	125

### Freight Class Key

**Number** LTL freight class  
**P** Parcel Service  
**+** \$15 surcharge (over 48" long)

**Example:** A freight code of 125 P+ indicates a item that may ship as freight class 125 or via parcel service with \$15 surcharge.

**Note:** for alternate installation of Ultimate Access screens, additional set (pair) of brackets is required. Part No. C502.279

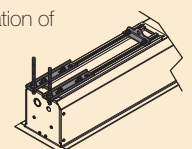

# Ultimate Access XL E

ELECTRIC SCREENS

## XL Self-supporting, electric screen with motorized closure

Motor-in-roller electric screen for ceiling-recessed installation. White finished folded steel case. No exposed fasteners. Independently motorized ceiling closure opens into the case. Plenum rated case (UL approved "Suitable for Use in Environmental Air Space"). Includes one 110-120v 3-position switch. Left hand motor location only. Viewing surfaces available from the OptiView and ClearSound families.

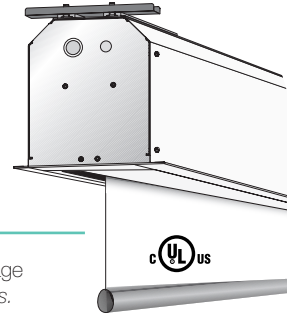

### STANDARD SPECS

- **Sizes and Formats:** Custom sizes by quotation. Custom sizes need to be specified in detail, including extra drop, if desired.
- **Case Dimensions:** Case is 14 1/16" H x 10 3/8" D (includes flange and mounting brackets). Case lengths below include flange to support ceiling tile or trim ceiling opening. Built in controls may increase length of case: call Draper for dimensions.
- **Black Borders:** NTSC, HDTV, and 16:10 format have image area framed with black on all four sides. Black side borders are available on request for AV format screens.

### OPTIONS

- **Motor/Control Options:** Built-in Low-Voltage Controller (U) available. See page 10 for details. 220V motor is also available at no extra cost
- **Case Options:** All ceiling recessed cases can be painted black upon request. \$15 charge per lineal ft.
- **Extra Drop:** Additional drop above image (specify color— surface color standard for AV format; black standard for all others). See page 5.

H x W / Diagonal	Image Area	Overall Size	OptiView Viewing Surfaces			ClearSound Viewing Surfaces			Case Length	Ship Wt.	Freight Class
			Matt White XT1000E	Contrast Grey XH800E	PRICE	ClearSound White Weave XT900E	ClearSound Grey Weave XH600E	PRICE			
<b>16:10 Format</b>											
189"	100" x 160"	105" x 164"	144001	144001EC	\$8860	144001SA	144001SB	\$10655	177 3/4"	573	125
198"	105" x 168"	110" x 172"	144002	144002EC	9327	144002SA	144002SB	14463	185 3/4"	578	125
222"	117 1/2" x 188"	122" x 192"	144003	144003EC	9624	--	--	--	205 3/4"	626	125
255"	135" x 216"	140" x 220"	144004	144004EC	10884	--	--	--	233 3/4"	675	125
278"	147 1/2" x 236"	152 1/2" x 240"	144005	144005EC	11302	--	--	--	257 1/4"	709	125
307"	162 1/2" x 260"	167 1/2" x 264"	144006	144006EC	11471	--	--	--	281 1/4"	751	125
<b>16:9 HDTV Format</b>											
184"	90" x 160"	95" x 164"	144007	144007EC	\$8860	144007SA	144007SB	\$10655	177 3/4"	573	125
193"	94 1/2" x 168"	99 1/2" x 172"	144008	144008EC	9327	144008SA	144008SB	14463	185 3/4"	578	125
220"	106" x 188"	111" x 192"	144009	144009EC	9624	144009SA	144009SB	17547	205 3/4"	588	125
248"	121 1/2" x 216"	126 1/2" x 220"	144010	144010EC	10884	--	--	--	233 3/4"	665	125
270"	133" x 236"	138 1/2" x 240"	144011	144011EC	11302	--	--	--	257 1/4"	697	125
300"	146" x 260"	151" x 264"	144012	144012EC	12031	--	--	--	281 1/4"	741	125
<b>4:3 NTSC Video Format</b>											
200"	118" x 158"	123" x 162"	144013	144013EC	\$8860	--	--	--	175 3/4"	578	125
210"	126" x 168"	131" x 172"	144014	144014EC	9327	--	--	--	185 3/4"	588	125
220"	132" x 176"	137" x 180"	144015	144015EC	9447	--	--	--	193 3/4"	598	125
230"	138" x 184"	143" x 188"	144016	144016EC	9532	--	--	--	201 3/4"	613	125
240"	141" x 188"	146" x 192"	144017	144017EC	9624	--	--	--	205 3/4"	640	125
250"	148" x 198"	153" x 202"	144018	144018EC	10379	--	--	--	215 3/4"	668	125
270"	162" x 216"	167" x 220"	144019	144019EC	10884	--	--	--	233 3/4"	697	125
24' 7"	177" x 236"	182" x 240"	144020	144020EC	11302	--	--	--	257 1/4"	734	125
27' 6"	194" x 260"	198" x 264"	144021	144021EC	12357	--	--	--	281 1/4"	785	125
<b>AV Format</b>											
14' x 14'			144023	144023EC	\$10045	--	--	--	185 3/4"	804	125
16' x 16'			144024	144024EC	10604	--	--	--	205 3/4"	864	125
13' 6" x 18'			144025	144025EC	10884	--	--	--	229 3/4"	862	125
18' x 18'			144026	144026EC	11714	--	--	--	233 1/4"	925	125
8' x 20'			144027	144027EC	12474	--	--	--	253 3/4"	935	125
15' x 20'			144028	144028EC	12499	--	--	--	257 1/4"	950	125
20' x 20'			144029	144029EC	12534	--	--	--	257 1/4"	955	125
11' x 22'			144030	144030EC	12749	--	--	--	281 1/4"	950	125
16' 6" x 22'			144031	144031EC	12964	--	--	--	281 1/4"	986	125

**Note:** for alternate installation of Ultimate Access XL screens, additional set (pair) of brackets is required. Part No. C502.280

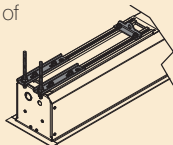



# Paragon E

ELECTRIC SCREENS  
CEILING-RECESSED

The Paragon is a large, ceiling-recessed screen designed for auditoriums and lecture halls. Offered in both tab-tensioned, and self-supporting, it features a white extruded aluminum case. Operates on a 6" steel roller powered by an extremely strong tubular motor-in-roller. Plenum rated case (UL approved "Suitable for Use in Environmental Air Space"). Includes one 110-120V 3-position switch. **Paragon sizes with a case length of 300" or more require special handling. Request a freight estimate.**

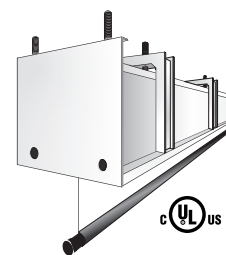

ELECTRIC SCREENS

## STANDARD SPECS

- **Case Dimensions:** Case is 13 1/4" H x 12" D.
- **Black Borders:** Image area framed with black on all four sides. 12" black drop at top of viewing surface (standard).

## OPTIONS

- **Motor/Control Options:** 220V options available. *P*page 35.
- **Case Options:** All ceiling recessed cases can be painted black upon request. \$15 charge per lineal ft.
- **Extra Drop:** Additional drop above image area: specify color of extra drop (surface color standard for AV; black for other formats). See page 36.

H x W/ Diagonal	Image Area	Overall Size	OptiView Surface		Case Length	Ship Wt./lbs.	Freight Class
			Matt White XT1000E	PRICE			
<b>16:10 Format</b>							
278"	147 1/2" x 236"	152 1/2" x 240"	114228	\$6315	250"	775	125
307"	162 1/2" x 260"	167 1/2" x 264"	114229	6645	274"	950	125
335"	177" x 284"	182" x 288"	114230	8637	298"	970	125
363"	192 1/2" x 308"	197 1/2" x 312"	114231	20286	322"	993	125
392"	207 1/2" x 332"	212 1/2" x 336"	114232	22596	346"	1220	125
<b>16:9 HDTV Format</b>							
270"	133" x 236"	138" x 240"	114209	\$6315	250"	828	125
300"	146" x 260"	151" x 264"	114210	6645	274"	950	125
324"	160" x 284"	165" x 288"	114211	8637	298"	970	125
354"	173" x 308"	178" x 312"	114216	20286	322"	1039	125
384"	187" x 332"	192" x 336"	114208	22596	346"	1220	125
<b>4:3 NTSC Video Format</b>							
25"	177" x 236"	182" x 240"	114113	\$6315	250"	872	125
27' 6"	194" x 260"	198" x 264"	114115	6645	274"	895	125
30"	212" x 284"	217" x 288"	114117	8637	298"	1033	125
32' 6"	230" x 308"	235" x 312"	114119	20462	322"	1045	125
35"	248" x 332"	253" x 336"	114121	23678	346"	1050	125
<b>AV Format</b>							
15' x 20'			114081	\$6501	250"	796	125
20' x 20'			114083	6918	250"	805	125
11' x 22'			114085	6670	274"	840	125
16' 6" x 22'			114087	6841	274"	850	125
22' x 22'			114089	7021	274"	861	125
12' x 24'			114091	7088	298"	930	125
18' x 24'			114093	8890	298"	950	125
24' x 24'			114095	11214	298"	961	125
13' x 26'			114097	16128	322"	970	125
19' 6" x 26'			114099	21766	322"	980	125
14' x 28'			114101	20499	346"	1000	125
21' x 28'			114103	24377	346"	1094	125

## ACCESSORIES FOR PARAGON E

White Part No.	Black Part No.	PRICE	Ship Wt./lbs	Freight Class
<b>Wall Mounting Brackets (pr.)</b> —For wall installation. Includes hardware for attaching brackets to case.				
121204	121278	\$150	6	50 P
<b>Ceiling Trim Flange for Paragon endcaps (pr.)</b> —For endcaps. Includes hardware for attaching flanges to case.				
121205	121279	\$53	20	50 P
<b>Ceiling Trim Flange for Paragon case</b> —12' length of ceiling trim flange, with hardware for attaching it to case. Please divide length of case requiring trim (in feet) by 12 and round up to determine number of kits to order. Remember to order trim for both front and back of case if required.				
121206	121280	\$53	12	77.5 P+

# Rolleramic

## Self-supporting, ceiling-recessed electric screen with wooden case

The Rolleramic's heavy-duty gear motor operates a 5" diameter roller. It is housed in a square case of high compression particle board painted flat black. Includes one 110-120v 3-position switch. Viewing surfaces from the OptiView family. Universal mounting brackets are included (two for sizes to 14' x 14'; three for larger sizes). Additional brackets available. Part No. 2113.50.

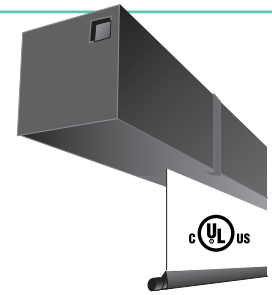

### STANDARD SPECS

- **Sizes and Formats:** Other formats and custom sizes available by quotation. Custom sizes need to be specified in detail, including extra drop, if desired.
- **Case Dimensions:** Case 9 1/8" H x 9 1/8" D (excluding brackets).
- **Black Borders:** NTSC, HDTV, and 16:10 format have image area framed with black on all four sides. Black side borders are available on request for AV format screens.

### OPTIONS

- **Motor/Control Options:** 220V options available. See page 35.
- **Extra Drop:** Additional drop above image area (specify color of extra drop—surface color standard for AV; black for other formats). See page 36.
- **Heavy-Duty Motor Rules Note:** Sizes 10'6" x 14' and larger include heavy-duty motor and roller. This motor is also required whenever total fabric (including extra drop) exceeds 144 sq. ft. See page 35.

\*These sizes include 12" black drop as standard—NO EXTRA CHARGE!

#### OptiView Viewing Surfaces

H x W / Diagonal	Image Area	Overall Size	Matt White XT1000E	Contrast Grey XH800E	PRICE	Case Length	Ship Wt./lbs.	Freight Class
<b>16:10 Format</b>								
94"	50" x 80"	62" x 83 1/2"	115380	115400	\$2569	108"	136	125
109"	57 1/2" x 92"	70" x 96"	115381	115401	2607	120"	154	125
113"	60" x 96"	72" x 100"	115511	115513	2626	124"	160	125
123"	65" x 104"	69" x 108"	115382	115402	2679	132"	172	125
137"	72 1/2" x 116"	76 1/2" x 120"	115383	115403	2909	144"	183	125
165"	87 1/2" x 140"	92 1/2" x 144"	115384	115404	3134	168"	220	125
189"	100" x 160"	105" x 164"	115385	115440	3734	194"	349	125
198"	105" x 168"	110" x 172"	115386	115441	3821	202"	420	125
222"	117 1/2" x 188"	122 1/2" x 192"	115387	115442	4258	222"	437	125
234"	123 3/4" x 198"	128 3/4" x 202"	115388	115443	4723	232"	459	125
278"	147 1/2" x 236"	152 1/2" x 240"	115389	--	6225	270"	509	125
<b>16:9 HDTV Format</b>								
92"	45" x 80"	57" x 83 1/2"	115244	115264	\$2569	108"	151	125
106"	52" x 92"	64" x 96"	115245	115265	2607	120"	154	125
110"	54" x 96"	66" x 100"	115505	115507	2626	124"	130	125
119"	58" x 104"	62" x 108"	115246	115266	2679	132"	170	125
133"	65" x 116"	69" x 120"	115247	115267	2909	144"	180	125
161"	79" x 140"	84" x 144"	115248	115268	3134	168"	229	125
184"	90" x 160"	95" x 164"	115249	115269	3734	194"	347	125
193"	94 1/2" x 168"	99 1/2" x 172"	115250	115451	3821	202"	353	125
220"	106" x 188"	111" x 192"	115251	115452	4258	222"	400	125
227"	111 1/2" x 198"	116 1/2" x 202"	115252	115453	4723	232"	459	125
270"	133" x 236"	138" x 240"	115253	115454	6225	270"	509	125
<b>4:3 NTSC Video Format</b>								
7'	50" x 66 1/2"	53 1/2" x 69 1/2"	115023	115172	\$2559	94"	130	125
100"	60" x 80"	64" x 83 1/2"	115024	115173	2617	108"	138	125
10'	69" x 92"	73" x 96"	115025	115174	2739	120"	154	125
11'	78" x 104"	83" x 108"	115026	115175	2856	132"	170	125
150"	87" x 116"	92" x 120"	115027	115176	2967	144"	180	125
15'	105" x 140"	109" x 144"	115028	115455	3151	168"	200	125
200"	118" x 158"	123" x 162"	115029	115456	3666	192"	345	125
20'	141" x 188"	146" x 192"	115030	115457	4249	222"	403	125
250"	148" x 198"	153" x 202"	115031	--	5023	232"	442	125
25'	177" x 236"	182" x 240"	115032	--	6225	270"	510	125
<b>AV Format</b>								
70" x 70"			115003	115164	\$2636	94"	144	125
84" x 84"			115004	115165	2692	108"	163	125
72" x 96"			115005	115166	2739	120"	167	125
96" x 96"			115006	115167	2782	120"	178	125
7' x 9'			115007	115168	2879	132"	185	125
9' x 9'			115008	115445	3019	132"	191	125
8' x 10'			115009	115169	3052	144"	192	125
10' x 10'			115010	115447	3134	144"	197	125
9' x 12'			115011	115446	3151	168"	229	125
12' x 12'			115012	115450	3434	168"	245	125
10' 6" x 14'			115013	115448	4181	198"	300	125
14' x 14'			115014	--	4293	198"	350	125
12' x 16'			115015	115449	4551	222"	400	125
16' x 16'			115016	--	4679	222"	421	125
13' 6" x 18'			115017	--	5691	246"	444	125
18' x 18'			115018	--	5838	246"	450	125
8' x 20'			115019	115444	6096	270"	456	125
15' x 20'			115020	--	6345	270"	492	125
20' x 20'			115021	--	6808	270"	493	125

**Freight Class Key**

**Number** LTL freight class  
**P** Parcel Service  
**+** \$15 surcharge (over 48" long)

**Example:** A freight code of 125 P+ indicates a item that may ship as freight class 125 or via parcel service with \$15 surcharge.

## Self-supporting electric screen

Popular electric screen. Housed in a pentagonal aluminum case, finished white with matching endcaps that also serve as a universal mounting bracket. Very reasonably priced; powered by a tubular motor-in-roller. Includes one 110-120v 3-position switch. Viewing surfaces from the OptiView and ClearSound families.

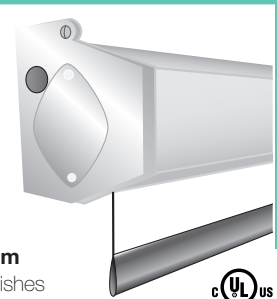

### STANDARD SPECS

- **Sizes and Formats:** Custom sizes available by quotation. Custom sizes need to be specified in detail, including extra drop, if desired.
- **Case Dimensions:** Standard case is 5 7/8" H x 5 1/4" D, including endcaps with universal mounting brackets. Optional built-in controls and extra drop may increase case length: call Draper for dimensions.
- **Black Borders:** NTSC, HDTV, and 16:10 have image area frames with black on all sides. Black borders on AV format available upon request.

### OPTIONS

- **Motor/Control Options:** (Q) Quiet Motor, (U or L) Built-in Low-Voltage Controller, and (P) Plug & Play™ available. See page 35 for details. 220V motor is also available at no extra cost.
- **Extra Drop:** Additional drop above image area (specify color—viewing area color standard for AV; black for other formats).
- **Floating Screen Brackets** Optional wall/ceiling mounting brackets for added flexibility. For use with small case only. See page 28.

- **Ceiling Opening Trim Kit:** Optional trim kit finishes opening for recessed installation in acoustical drop ceilings. See page 28.

\* Sizes footnoted below include 12" black drop as standard—NO EXTRA CHARGE!

		OptiView Viewing Surfaces					PRICE	Case Length	Ship Wt./lbs.	Dim Wt./lbs.	Freight Class	
H x W / Diagonal	Image Area	Overall Size	Matt White XT1000E	Contrast Grey XH800E	Contrast White XH1100E	Argent White XH1500E						Pearl White CH1900E
<b>16:10 Format</b>												
76"	40" x 64"	52" x 69 1/2"	116365	116373	116365EG	116365EH	116365EJ	\$1034	76 1/2"	51	58	125 P+
85"	45" x 72"	57" x 74"	116366	116374	116366EG	116366EH	116366EJ	1060	81"	53	60	125 P+
94"	50" x 80"	62" x 83 1/2"	116367	116375	116367EG	116367EH	116367EJ	1087	90 1/2"	57	69	125 P+
109"	57 1/2" x 92"	69 1/2" x 96"	116368	116376	116368EG	116368EH	116368EJ	1129	103"	62		125
113"	60" x 96"	72" x 100"	116530	116532	116530EG	116530EH	--	1154	107"	66		125
123"	65" x 104"	69" x 108"	116369	116377	116369EG	116369EH	--	1194	115"	69		125
137"	72 1/2" x 116"	76 1/2" x 120"	116370	116378	116370EG	116370EH	--	1255	127"	75		125
165"	87 1/2" x 140"	92 1/2" x 144"	116371	116379	--	--	--	1330	151"	94		125
189"	100" x 160"	105" x 164"	116482	116502	--	--	--	2526	171"	102		125
<b>16:9 HDTV Format</b>												
73"	36" x 64"	48" x 69 1/2"	116279	116285	116279EG	116279EH	116279EJ	\$1034	76 1/2"	51	58	125 P+
82"	40 1/2" x 72"	52 1/2" x 74"	116280	116286	116280EG	116280EH	116280EJ	1060	81"	53	60	125 P+
92"	45" x 80"	57" x 83 1/2"	116300	116304	116300EG	116300EH	116300EJ	1087	90 1/2"	58	69	125 P+
100"	49" x 87"	61" x 91"	116454	116456	116454EG	116454EH	116454EJ	1112	98"	60		125
106"	52" x 92"	64" x 96"	116301	116305	116301EG	116301EH	116301EJ	1129	103"	62		125
110"	54" x 96"	66" x 100"	116469	116471	116469EG	116469EH	--	1154	107"	65		125
119"	58" x 104"	62" x 108"	116240	116247	116240EG	116240EH	--	1194	115"	68		125
133"	65" x 116"	69" x 120"	116022	116193	116022EG	116022EH	--	1255	127"	77		125
161"	79" x 140"	84" x 144"	116023	116194	--	--	--	1330	151"	94		125
184"	90" x 160"	95" x 164"	116255	116257	--	--	--	2526	171"	105		125
<b>4:3 NTSC Video Format</b>												
7'	50" x 66 1/2"	53 1/2" x 69 1/2"	116014	116186	116014EG	116014EH	116014EJ	\$1019	76 1/2"	51	60	125 P+
100"	60" x 80"	64" x 83 1/2"	116015	116187	116015EG	116015EH	116015EJ	1082	90 1/2"	53	69	125 P+
10'	69" x 92"	73" x 96"	116016	116188	116016EG	116016EH	116016EJ	1135	103"	67		125
11'	78" x 104"	83" x 108"	116017	116189	116017EG	116017EH	--	1215	115"	71		125
150"	87" x 116"	92" x 120"	116018	116190	116018EG	116018EH	--	1244	127"	75		125
15'	105" x 140"	109" x 144"	116019	116512	--	--	--	1425	151"	92		125
16' 8"	118" x 162"	123" x 162"	116249	116513	--	--	--	2392	169"	118		125
<b>AV Format</b>												
70" x 70"			116003	116179	116003EG	116003EH	116003EJ	\$997	76 1/2"	51	60	125 P+
84" x 84"			116004	116180	116004EG	116004EH	116004EJ	1097	90 1/2"	53	69	125 P+
72" x 96"			116005	116181	116005EG	116005EH	116005EJ	1124	103"	63		125
96" x 96"			116006	116182	116006EG	116006EH	116006EJ	1184	103"	66		125
7' x 9'			116007	116183	116007EG	116007EH	--	1214	115"	68		125
9' x 9'			116008	116505	--	--	--	1382	115"	73		125
8' x 10'			116009	116184	116009EG	116009EH	--	1367	127"	74		125
10' x 10'			116010	116507	--	--	--	1510	127"	81		125
9' x 12'			116011	116506	--	--	--	1569	151"	95		125
12' x 12'			116012	116508	--	--	--	2502	151"	114		125

Please Note: Case length will increase by 2" for Targa with (U) Built-in Low-Voltage Controller LVC-IV.

CONTINUED



CHART

# Targa (Continued)

## ACCESSORIES FOR TARGA—THESE ACCESSORIES ARE NOT COMPATIBLE WITH TARGA XL.

**Ceiling Opening Trim Kit**—Designed for recessed installation in acoustical drop ceilings of Targa motorized screens. Ships knocked down; assembles quickly with fasteners provided. Trims out the ceiling tile opening and attaches to screen endcaps. Painted white. Slot includes finished flange to accept acoustical ceiling tile or grid. Slot measures 2 1/8" in depth. Once installed, the finished slot length is equal to the Targa screen case length.

**Floating Screen Brackets**—Use Draper's Floating Screen Brackets for added flexibility and secure mounting of the Targa even when available installation points are not located at the end of the case. Simply secure front and rear case brackets to screen case, attach wall/ceiling brackets to secure install points, then attach case brackets to wall/ceiling brackets. Available in black or white finish.

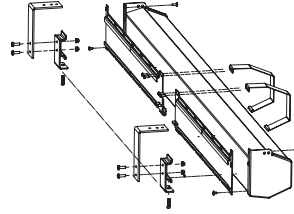

Finished Slot Length	Screen Case Length	Part No.	PRICE	Ship Wt./lbs.	Freight Class
102 1/2"	102 1/2" and shorter	121202	\$198	31	77.5
126 1/2"	102 1/2" – 126 1/2"	121203	217	36	77.5
174"	126 1/2" – 174"	121207	248	49	77.5

Floating Screen Brackets (pr.)	Part No.	PRICE	Shipping Wt./lbs.
White Finish	227025	\$100	11
Black Finish	227024	100	11

Non-Adjustable Wall Brackets	Part No.	PRICE	Shipping Wt./lbs.
6" Extension (white)	227212	\$26	2
6" Extension (black)	227213	26	2

\* Sizes footnoted below include 12" black drop as standard—NO EXTRA CHARGE!

### ClearSound Viewing Surfaces

H x W / Diagonal	Image Area	Overall Size	ClearSound White Weave XT900E	ClearSound Grey Weave XH600E	PRICE	Case Length	Ship Wt./lbs.	Dim Wt./lbs.	Freight Class
<b>16:10 Format</b>									
76**	40" x 64"	52" x 69 1/2"	116365SA	116365SB	\$3556	76 1/2"	51	58	125 P+
85**	45" x 72"	57" x 74"	116366SA	116366SB	3954	81"	53	60	125 P+
94**	50" x 80"	62" x 83 1/2"	116367SA	116367SB	4393	90 1/2"	57	69	125 P+
109**	57 1/2" x 92"	69 1/2" x 96"	116368SA	116368SB	4879	103"	62		125
113**	60" x 96"	72" x 100"	116530SA	116530SB	5424	107"	66		125
123"	65" x 104"	69" x 108"	116369SA	116369SB	6026	115"	69		125
137"	72 1/2" x 116"	76 1/2" x 120"	116370SA	116370SB	6696	127"	75		125
<b>16:9 HDTV Format</b>									
73**	36" x 64"	48" x 69 1/2"	116279SA	116279SB	\$3244	76 1/2"	51	58	125 P+
82**	40 1/2" x 72"	52 1/2" x 74"	116280SA	116280SB	3606	81"	53	60	125 P+
92**	45" x 80"	57" x 83 1/2"	116298	116296	4004	90 1/2"	58	69	125 P+
100**	49" x 87"	61" x 91"	116453	116452	4579	98"	60		125
106**	52" x 92"	64" x 96"	116299	116297	5358	103"	62		125
110**	54" x 96"	66" x 100"	116468	116467	5546	107"	65		125
119"	58" x 104"	62" x 108"	116244	116239	6521	115"	68		125
133"	65" x 116"	69" x 120"	116110	116234	6651	127"	77		125
161"	79" x 140"	84" x 144"	116444	116445	6780	151"	94		125
184"	90" x 160"	95" x 164"	116434	116435	7590	171"	105		125
<b>4:3 NTSC Video Format</b>									
100"	60" x 80"	64" x 83 1/2"	116106	116230	\$4348	90 1/2"	53	69	125 P+
10'	69" x 92"	73" x 96"	116107	116231	6343	103"	67		125
11'	78" x 104"	83" x 108"	116450	116451	6598	115"	71		125
150"	87" x 116"	92" x 120"	116446	116447	6636	127"	75		125

# Targa XL

ELECTRIC SCREENS  
WALL/CEILING MOUNTED

## Large version of the Targa Self-supporting electric screen

Popular electric screen. Housed in a steel case, finished white with matching endcaps that also serve as a universal mounting bracket. Very reasonably priced; powered by a tubular motor-in-roller. Includes one 110-120v 3-position switch. Viewing surfaces from the OptiView and ClearSound families.

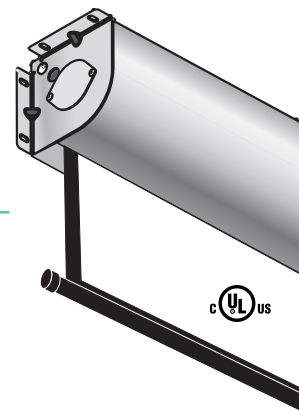

ELECTRIC SCREENS

### STANDARD SPECS

- **Sizes and Formats:** Custom sizes available by quotation. Custom sizes need to be specified in detail, including extra drop, if desired.
- **Case Dimensions:** Standard case is 6 3/4" H x 6 3/4" D, including endcaps with universal mounting brackets. Optional built-in controls and extra drop may increase case length: call Draper for dimensions.
- **Black Borders:** NTSC, HDTV, and 16:10 have image area frames with black on all sides. Black borders on AV format available upon request.

### OPTIONS

- **Motor/Control Options:** (U or L) Built-in Low-Voltage Controller, and (LP) Low-Voltage Controller with Plug & Play™ available. See page 36 for details. 220V motor is also available at no extra cost.
- **Extra Drop:** Additional drop above image area (specify color—viewing area color standard for AV; black for other formats).

Not compatible with 6" Extension Brackets, Floating Brackets, Ceiling Opening Trim Kit, or optional Q and QL motors.

#### OptiView Viewing Surfaces

H x W / Diagonal	Image Area	Overall Size	Matt White XT1000E	Contrast Grey XH800E	PRICE	Case Length	Ship Wt./lbs.	Freight Class
<b>16:10 Format</b>								
198"	105" x 168"	110" x 172"	116485	116503	\$2984	180 7/8"	250	125
222"	117 1/2" x 188"	122" x 192"	116486	116504	3709	200 7/8"	290	125
<b>16:9 HDTV Format</b>								
193"	94 1/2" x 168"	99 1/2" x 172"	116343	116510	\$2984	180 7/8"	243	125
220"	106" x 188"	111" x 192"	116344	116511	3709	200 7/8"	274	125
<b>4:3 NTSC Video Format</b>								
210"	126" x 168"	131" x 172"	116341	116514	\$3077	180 7/8"	270	125
240"	141" x 188"	146" x 192"	116342	116515	3709	200 7/8"	293	125
<b>AV Format</b>								
14' x 14'			116338	--	\$3139	176 7/8"	268	125
12' x 16'			116339	116509	3604	200 7/8"	299	125
16' x 16'			116340	--	3711	200 7/8"	300	125

#### ClearSound Viewing Surfaces

H x W / Diagonal	Image Area	Overall Size	ClearSound White Weave XT900E	ClearSound Grey Weave XH600E	PRICE	Case Length	Ship Wt./lbs.	Freight Class
<b>16:9 HDTV Format</b>								
193"	94 1/2" x 168"	99 1/2" x 172"	116343SA	116343SB	\$9965	180 7/8"	243	125
220"	106" x 188"	111" x 192"	116344SA	116344SB	12252	200 7/8"	274	125

#### Freight Class Key

**Number** LTL freight class  
**P** Parcel Service  
**+** \$15 surcharge (over 48" long)

**Example:** A freight code of 125 P+ indicates a item that may ship as freight class 125 or via parcel service with \$15 surcharge.

# Silhouette E

## Self-supporting electric screen

Self-supporting screen for wall/ceiling installation, with streamlined extruded white aluminum case. No exposed fasteners or mounting fixtures. Viewing surfaces from the OptiView and ClearSound families.

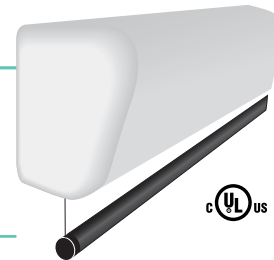

### STANDARD SPECS

- **Sizes and Formats:** Custom sizes available by quotation. Custom sizes need to be specified in detail, including extra drop, if desired.
- **Case Dimensions:** 6" H x 4 3/4" D. Optional built-in controls may increase case length: call Draper for dimensions.
- **Black Masking Borders:** NTSC, HDTV, and 16:10 format have image area framed with black on all four sides. Black side borders are available on request for AV format screens.

### OPTIONS

- **Motor/Control Options:** (Q) Quiet Motor, (U or L) Built-in Low-Voltage Controller (Adds to case length), and (P) Plug & Play™ available. See page 35 for details. 220V motor is also available at no extra cost.
- **Extra Drop:** Additional drop above image area (specify color—viewing area color standard for AV; black for other formats).
- **Finish Options:** White or Black case finish available at no extra charge.

\*These sizes include 12" black drop as standard—NO EXTRA CHARGE!

OptiView Viewing Surfaces													
H x W / Diagonal	Image Area	Overall Size	Matt White XT1000E	Contrast Grey XH800E	Contrast White XH1100E	Argent White XH1500E	Pearl White CH1900E	PRICE	Case Length	Ship Wt./lbs.	Dim Wt./lbs.	Freight Class	
<b>16:10 Format</b>													
67"	35 1/2" x 56 1/2"	47 1/2" x 59 1/2"	108350	108355	108350EG	108350EH	108350EJ	\$1370	71 1/2"	42	56	125	P+
76"	40" x 64"	52" x 69 1/2"	108351	108356	108351EG	108351EH	108351EJ	1409	81 1/2"	48	62	125	P+
85"	45" x 72"	57" x 74"	108352	108357	108352EG	108352EH	108352EJ	1464	86"	50	64	125	P+
94"	50" x 80"	62" x 83 1/2"	108353	108358	108353EG	108353EH	108353EJ	1489	95 1/2"	55	70	125	P+
109"	57 1/2" x 92"	69 1/2" x 96"	108354	108359	108354EG	108354EH	108354EJ	1545	108"	60			125
113"	60" x 96"	72" x 100"	108410	108412	108410EG	108410EH	--	1572	112"	60			125
<b>16:9 HDTV Format</b>													
65"	31 3/4" x 56 1/2"	43 3/4" x 59 1/2"	108300	108306	108300EG	108300EH	108300EJ	\$1370	71 1/2"	42	56	125	P+
73"	36" x 64"	48" x 69 1/2"	108301	108307	108301EG	108301EH	108301EJ	1409	81 1/2"	48	62	125	P+
82"	40 1/2" x 72"	52 1/2" x 74"	108302	108308	108302EG	108302EH	108302EJ	1464	86"	54	64	125	P+
92"	45" x 80"	57" x 83 1/2"	108322	108326	108322EG	108322EH	108322EJ	1489	95 1/2"	56	71	125	P+
100"	49" x 87"	61" x 91"	108392	108394	108392EG	108392EH	108392EJ	1515	103"	58			125
106"	52" x 92"	64" x 96"	108323	108327	108323EG	108323EH	108323EJ	1545	108"	60			125
110"	54" x 96"	66" x 100"	108400	108402	108400EG	108400EH	--	1572	112"	60			125
<b>4:3 NTSC Video Format</b>													
6'	42 1/2" x 56 1/2"	46 1/2" x 59 1/2"	108220	108276	108220EG	108220EH	108220EJ	\$1360	71 1/2"	42	56	125	P+
7'	50" x 66 1/2"	53 1/2" x 69 1/2"	108221	108277	108221EG	108221EH	108221EJ	1400	81 1/2"	48	62	125	P+
100"	60" x 80"	64" x 83 1/2"	108222	108278	108222EG	108222EH	108222EJ	1472	95 1/2"	54	71	125	P+
10'	69" x 92"	73" x 96"	108223	108279	108223EG	108223EH	108223EJ	1537	108"	70			125
<b>AV Format</b>													
60" x 60"			108215	108271	108215EG	108215EH	108215EJ	\$1342	71 1/2"	42	55	125	P+
70" x 70"			108216	108272	108216EG	108216EH	108216EJ	1369	81 1/2"	48	62	125	P+
84" x 84"			108217	108273	108217EG	108217EH	108217EJ	1485	95 1/2"	65	71	125	P+
72" x 96"			108218	108274	108218EG	108218EH	108218EJ	1515	108"	70			125
96" x 96"			108219	108275	108219EG	108219EH	108219EJ	1594	108"	72			125

ClearSound Viewing Surfaces													
H x W / Diagonal	Image Area	Overall Size	ClearSound White Weave XT900E	ClearSound Grey Weave XH600E	PRICE	Case Length	Ship Wt./lbs.	Dim Wt./lbs.	Freight Class				
<b>16:10 Format</b>													
76"	40" x 64"	52" x 69 1/2"	108351SA	108351SB	\$4504	81 1/2"	48	62	125	P+			
85"	45" x 72"	57" x 74"	108352SA	108352SB	4681	86"	50	64	125	P+			
94"	50" x 80"	62" x 83 1/2"	108353SA	108353SB	4759	95 1/2"	55	70	125	P+			
109"	57 1/2" x 92"	69 1/2" x 96"	108354SA	108354SB	4943	108"	60			125			
113"	60" x 96"	72" x 100"	108410SA	108410SB	5029	112"	60			125			
<b>16:9 HDTV Format</b>													
73"	36" x 64"	48" x 69 1/2"	108301SA	108301SB	\$4504	81 1/2"	48	62	125	P+			
82"	40 1/2" x 72"	52 1/2" x 74"	108302SA	108302SB	4681	86"	54	64	125	P+			
92"	45" x 80"	57" x 83 1/2"	108320	108318	4781	95 1/2"	56	71	125	P+			
100"	49" x 87"	61" x 91"	108391	108390	4883	103"	58			125			
106"	52" x 92"	64" x 96"	108321	108319	6736	108"	60			125			
110"	54" x 96"	66" x 100"	108406	108408	6976	112"	60			125			
<b>4:3 NTSC Video Format</b>													
7'	50" x 66 1/2"	53 1/2" x 69 1/2"	108221SA	108221SB	\$4479	81 1/2"	48	62	125	P+			
100"	60" x 80"	64" x 83 1/2"	108240	108296	4861	95 1/2"	54	71	125	P+			
10'	69" x 92"	73" x 96"	108241	108297	6811	108"	70			125			

CHART CONTINUED BELOW



### Freight Class Key

**Number** LTL freight class  
**P** Parcel Service  
**+** \$15 surcharge (over 48" long)

**Example:** A freight code of 125 P+ indicates a item that may ship as freight class 125 or via parcel service with \$15 surcharge.

# Salara HW

ELECTRIC SCREENS  
WALL/CEILING MOUNTED

## Self-supporting electric screen

Elliptical extruded aluminum case with white finish installs quickly to wall brackets. Hardwired like other Draper projection screens. Can be furnished with any standard control option. Viewing surfaces from the OptiView and ClearSound families. Wall/Ceiling brackets available C104.066SA (Single Bracket).

### STANDARD SPECS

- **Case Dimensions:** Case is 3 13/16" H x 5 1/16" D.
- **Black Borders:** NTSC, HDTV, and 16:10 format have image area framed with black on all four sides. Black side borders are available on request for AV format screens.

### OPTIONS

- **Motor/Control Options:** 120V motor is standard. 220V motor is also available upon request. See page 35 for controls.
- **Extra Drop:** Additional drop above image (specify color—black is standard; surface color standard for AV format for all others). See page 36.

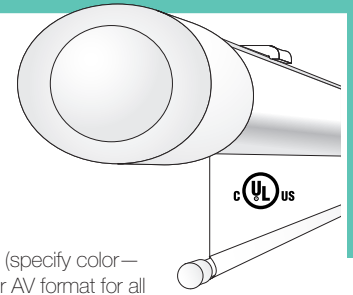

ELECTRIC SCREENS

\*These sizes include 12" black drop as standard—NO EXTRA CHARGE!

H x W / Diagonal	Image Area	Overall Size	OptiView Viewing Surfaces					Case Length	Ship Wt./lbs.	Dim Wt./lbs.	Freight Class	
			Matt White XT1000E	Contrast Grey XH800E	Contrast White XH1100E	Argent White XH1500E	Pearl White CH1900E					PRICE
<b>16:10 Format</b>												
76**	40" x 64"	52" x 69 1/2"	132172	132177	132172EG	132172EH	132172EJ	\$790	77 1/8"	36	45	125 P+
85**	45" x 72"	57" x 74"	132173	132178	132173EG	132173EH	132173EJ	835	81 5/8"	38	47	125 P+
94**	50" x 80"	62" x 83 1/2"	132174	132179	132174EG	132174EH	132174EJ	845	91 1/8"	40	54	125 P+
109**	57 1/2" x 92"	69 1/2" x 96"	132175	132180	132175EG	132175EH	132175EJ	894	103 5/8"	46		125
<b>16:9 HDTV Format</b>												
73**	36" x 64"	48" x 69 1/2"	132086	132092	132086EG	132086EH	132086EJ	\$790	77 1/8"	36	45	125 P+
82**	40 1/2" x 72"	52 1/2" x 74"	132087	132093	132087EG	132087EH	132087EJ	835	81 5/8"	38	49	125 P+
92**	45" x 80"	57" x 83 1/2"	132103	132107	132103EG	132103EH	132103EJ	845	91 1/8"	40	51	125 P+
100**	49" x 87"	61" x 91"	132211	132213	132211EG	132211EH	132211EJ	867	98 5/8"	46	57	125 P+
106**	52" x 92"	64" x 96"	132104	132108	132104EG	132104EH	132104EJ	894	103 5/8"	46		125
<b>4:3 NTSC Video Format</b>												
7'	50" x 66 1/2"	53 1/2" x 69 1/2"	132007	132033	132007EG	132007EH	132007EJ	\$783	77 1/8"	37	45	125 P+
100"	60" x 80"	64" x 83 1/2"	132008	132034	132008EG	132008EH	132008EJ	845	91 1/8"	42	57	125 P+
10'	69" x 92"	73" x 96"	132009	132035	132009EG	132009EH	132009EJ	894	103 5/8"	47		125
<b>AV Format</b>												
70" x 70"			132003	132029	132003EG	132003EH	132003EJ	\$768	77 1/8"	37	45	125 P+
84" x 84"			132004	132030	132004EG	132004EH	132004EJ	864	91 1/8"	39	53	125 P+
72" x 96"			132079	132081	132079EG	132079EH	132079EJ	895	103 5/8"	47		125
96" x 96"			132005	132031	132005EG	132005EH	132005EJ	947	103 5/8"	50		125

H x W / Diagonal	Image Area	Overall Size	ClearSound Viewing Surfaces			Case Length	Ship Wt./lbs.	Dim Wt./lbs.	Freight Class
			ClearSound White Weave XT900E	ClearSound Grey Weave XH600E	PRICE				
<b>16:10 Format</b>									
76**	40" x 64"	52" x 69 1/2"	132172SA	132172SB	\$3951	77 1/8"	36	45	125 P+
85**	45" x 72"	57" x 74"	132173SA	132173SB	4391	81 5/8"	38	47	125 P+
94**	50" x 80"	62" x 83 1/2"	132174SA	132174SB	4876	91 1/8"	40	54	125 P+
109**	57 1/2" x 92"	69 1/2" x 96"	132175SA	132175SB	5421	103 5/8"	46		125
<b>16:9 HDTV Format</b>									
73**	36" x 64"	48" x 69 1/2"	132086SA	132086SB	\$2919	77 1/8"	36	45	125 P+
82**	40 1/2" x 72"	52 1/2" x 74"	132087SA	132087SB	3242	81 5/8"	38	49	125 P+
92**	45" x 80"	57" x 83 1/2"	132119	132127	3604	91 1/8"	40	51	125 P+
100**	49" x 87"	61" x 91"	132217	132218	4274	98 5/8"	46	57	125 P+
106**	52" x 92"	64" x 96"	132120	132128	4943	103 5/8"	46		125
<b>4:3 NTSC Video Format</b>									
7'	50" x 66 1/2"	53 1/2" x 69 1/2"	132007SA	132007SB	\$3542	77 1/8"	37	45	125 P+
100"	60" x 80"	64" x 83 1/2"	132117	132125	3936	91 1/8"	42	57	125 P+
10'	69" x 92"	73" x 96"	132118	132126	5898	103 5/8"	47		125

CHART  
CONTINUED  
BELOW



### Freight Class Key

**Number** LTL freight class  
**P** Parcel Service  
**+** \$15 surcharge (over 48" long)

**Example:** A freight code of 125 P+ indicates a item that may ship as freight class 125 or via parcel service with \$15 surcharge.

# Salara Plug & Play

ELECTRIC SCREENS

## Self-supporting electric screen

Identical to Salara/HW, but comes with 10' power cord that plugs right into your wall's power outlet. Conventional electric screen with motor-in-roller.

### No wiring needed!

Also includes IR remote. Replacement IR Remote— part #121250. Wall/Ceiling brackets available C104.066SA (Single Bracket).

**\*These sizes include 12" black drop as standard—NO EXTRA CHARGE!**

OptiView Viewing Surfaces												
H x W / Diagonal	Image Area	Overall Size	Matt White XT1000E	Contrast Grey XH800E	Contrast White XH1100E	Argent White XH1500E	Pearl White CH1900E	PRICE	Case Length	Ship Wt./lbs.	Dim Wt./lbs.	Freight Class
<b>16:10 Format</b>												
76**	40" x 64"	52" x 69 1/2"	136194	136199	136194EG	136194EH	136194EJ	\$1102	77 1/8"	36	45	125 P+
85**	45" x 72"	57" x 74"	136195	136200	136195EG	136195EH	136195EJ	1145	81 5/8"	38	47	125 P+
94**	50" x 80"	62" x 83 1/2"	136196	136201	136196EG	136196EH	136196EJ	1165	91 1/8"	40	53	125 P+
109**	57 1/2" x 92"	69 1/2" x 96"	136197	136202	136197EG	136197EH	136197EJ	1219	103 5/8"	46		125
<b>16:9 HDTV Format</b>												
73**	36" x 64"	48" x 69 1/2"	136086	136092	136086EG	136086EH	136086EJ	\$1102	77 1/8"	36	45	125 P+
82**	40 1/2" x 72"	52 1/2" x 74"	136087	136093	136087EG	136087EH	136087EJ	1145	81 5/8"	38	49	125 P+
92**	45" x 80"	57" x 83 1/2"	136103	136107	136103EG	136103EH	136103EJ	1165	91 1/8"	40	54	125 P+
100**	49" x 87"	61" x 91"	136236	136238	136236EG	136236EH	136236EJ	1197	98 5/8"	43	57	125 P+
106**	52" x 92"	64" x 96"	136104	136108	136104EG	136104EH	136104EJ	1219	103 5/8"	46		125
<b>4:3 NTSC Video Format</b>												
7'	50" x 66 1/2"	53 1/2" x 69 1/2"	136007	136033	136007EG	136007EH	136007EJ	\$1095	77 1/8"	30	42	125 P+
100"	60" x 80"	64" x 83 1/2"	136008	136034	136008EG	136008EH	136008EJ	1154	91 1/8"	46	53	125 P+
10'	69" x 92"	73" x 96"	136009	136035	136009EG	136009EH	136009EJ	1205	103 5/8"	47		125
<b>AV Format</b>												
70" x 70"			136003	136029	136003EG	136003EH	136003EJ	\$1089	77 1/8"	37	45	125 P+
84" x 84"			136004	136030	136004EG	136004EH	136004EJ	1180	91 1/8"	39	53	125 P+
72" x 96"			136079	136081	136079EG	136079EH	136079EJ	1189	103 5/8"	40		125
96" x 96"			136005	136031	136005EG	136005EH	136005EJ	1270	103 5/8"	50		125

ClearSound Viewing Surfaces												
H x W / Diagonal	Image Area	Overall Size	ClearSound White Weave XT900E	ClearSound Grey Weave XH600E	PRICE	Case Length	Ship Wt./lbs.	Dim Wt./lbs.	Freight Class			
<b>16:10 Format</b>												
76**	40" x 64"	52" x 69 1/2"	136194SA	136194SB	\$4181	77 1/8"	36	45	125 P+			
85**	45" x 72"	57" x 74"	136195SA	136195SB	4644	81 5/8"	38	47	125 P+			
94**	50" x 80"	62" x 83 1/2"	136196SA	136196SB	5158	91 1/8"	40	53	125 P+			
109**	57 1/2" x 92"	69 1/2" x 96"	136197SA	136197SB	5731	103 5/8"	46		125			
<b>16:9 HDTV Format</b>												
73**	36" x 64"	48" x 69 1/2"	136086SA	136086SB	\$3169	77 1/8"	36	45	125 P+			
82**	40 1/2" x 72"	52 1/2" x 74"	136087SA	136087SB	3522	81 5/8"	38	49	125 P+			
92**	45" x 80"	57" x 83 1/2"	136119	136127	3912	91 1/8"	40	54	125 P+			
100**	49" x 87"	61" x 91"	136242	136243	4583	98 5/8"	43	57	125 P+			
106**	52" x 92"	64" x 96"	136120	136128	5253	103 5/8"	46		125			
<b>4:3 NTSC Video Format</b>												
7'	50" x 66 1/2"	53 1/2" x 69 1/2"	136007SA	136007SB	\$3822	77 1/8"	30	42	125 P+			
100"	60" x 80"	64" x 83 1/2"	136117	136125	4248	91 1/8"	46	53	125 P+			
10'	69" x 92"	73" x 96"	136118	136126	6211	103 5/8"	47		125			

CHART CONTINUED BELOW



### Freight Class Key

**Number** LTL freight class  
**P** Parcel Service  
**+** \$15 surcharge (over 48" long)

**Example:** A freight code of 125 P+ indicates a item that may ship as freight class 125 or via parcel service with \$15 surcharge.



## Outdoor, Self-supporting, electric screen

Designed for outdoor use on your patio, by your pool deck, or any other outdoor space. Weather- and insect-resistant solid aluminum square or curved headbox includes built-in hinge for easy installation and service. Ships standard with cable guides and weighted dowel. Both wall- and deck-mount cable guide brackets included. Viewing surfaces from the OptiView and ClearSound families. Choose the Nocturne+® C for manual crank operation. See page page 45.

### STANDARD SPECS

- **Sizes and Formats:** Custom sizes by quotation. Custom sizes need to be specified in detail, including extra drop, if desired.
- **Case Dimensions:** 3 5/8" H x 3 5/8" D. Optional built-in controls may increase case length: Call Draper for dimensions.
- **Black Borders:** Image area framed with 2" black border on all four sides.

### OPTIONS

- **Motor/Control Options:** 120V Motor is standard. 220V motor is also available. **\*Important\*** Optional switches and controls are *NOT* water resistant. It is the installer's responsibility to ensure that any hard wired controls are placed in an appropriate weatherproof fixture or location. See page 35.
- **Finish Options:** Headbox and exposed hardware standard in white. Also available in Silver, Ivory, Bronze, or Black. Custom powder coated colors available.
- **Extra Drop:** Additional drop above image (specify color—black standard; surface color available). See page 36.

H x W / Diagonal	Image Area	OptiView Viewing Surfaces			Case Length	Ship Wt./lbs.	Freight Class
		Matt White XT1000E	Contrast Grey XH800E	PRICE			
<b>16:10 Format</b>							
94**	50" x 80"	138019	138020	\$1344	86 7/8"	44	125 P+
102**	54" x 87"	138021	138022	1400	94 3/8"	47	125 P+
109**	57 1/2" x 92"	138023	138024	1439	99 3/8"	49	125
113**	60" x 96"	138025	138026	1474	103 3/8"	51	125
123"	65" x 104"	138027	138028	1569	111 3/8"	73	125
137"	72 1/2" x 116"	138029	138030	1734	123 3/8"	96	125
<b>16:9 HDTV Format</b>							
73**	36" x 64"	138003	138004	\$1265	72 7/8"	38	125 P+
82**	40 1/2" x 70"	138005	138006	1297	77 3/8"	40	125 P+
92**	45" x 80"	138007	138008	1337	86 7/8"	44	125 P+
100**	49" x 87"	138009	138010	1399	94 3/8"	59	125 P+
106**	52" x 92"	138011	138012	1430	99 3/8"	79	125
110**	54" x 96"	138013	138014	1470	103 3/8"	82	125
119"	58" x 104"	138015	138016	1554	111 3/8"	88	125
133"	65" x 116"	138017	138018	1749	123 3/8"	97	125
<b>4:3 NTSC Video Format</b>							
7'	50" x 66 1/2"	138033	138034	\$1265	72 7/8"	38	125 P+
100"	60" x 80"	138035	138036	1339	86 7/8"	44	125 P+
10'	69" x 92"	138037	138038	1502	99 3/8"	73	125
11'	78" x 104"	138039	138040	1594	111 3/8"	81	125
150"	87" x 116"	138041	138042	1655	123 3/8"	81	125

\*These sizes include 12" black drop as standard—NO EXTRA CHARGE!

## Patriot

### Motorized American flag

The Patriot displays an American flag either vertically or horizontally. Standard product includes a sewn, nylon American flag. Options include state flags or school banners, provided by customer (call for quotation). The flag rolls up into the case for storage, and rolls down for presentation at the turn of a key.

Choose Vertical or Horizontal display. Custom sizes available. Contact Draper for more details.

Description	Part No.	Price	Case Length	Shipping Wt./Lbs.	Freight Class
18' x 12'- Vertical Display	500101	\$4309	14'10"	340	125
12' x 18'- Horizontal Display	500102	4943	20'10"	456	125



Vertical Display shown

# Ropewalker

## Innovation for large venue screens

Ropewalker enables you to install a large, motorized projection screen high above the audience's line of sight in a large venue, then lower it into position when it's show time. The system consists of an inner and an outer case. The outer case is designed for ceiling recessed installation. The inner case contains the roller operated screen.

- Motorized assembly lowers entire screen from the ceiling using steel cables.
- When storing the screen, assembly is lifted back to ceiling, then screen is retracted.
- Eliminates black drop between the screen and tall ceilings.
- Ideal for most large venues, houses of worship, or gymnasiums.
- Available with tensioned and self-supporting viewing surfaces up to 18 feet wide.
- Comes with 6" of black drop standard.
- Optional Low-Voltage Controller available at an additional cost.
- **SAFETY FEATURE** – Safety cables with cable arresters connect the inner and outer cases at each end of case.

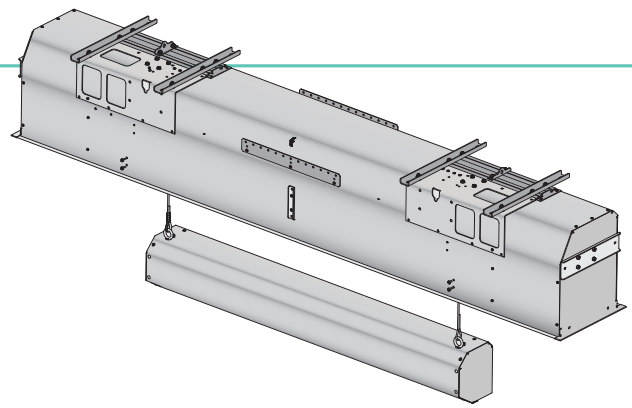

Max Screen Width	18 ft.
Operating Speed (Case)	20 ft. per minute
Operating Speed (Screen)	15 ft. per minute
Maximum Vertical Travel	34 ft.

### Sequence of Operation –

- 1. Down Cycle** – Screen surface unrolls, then inner case is lowered via stainless steel aircraft cables to the "show" position.
- 2. Up Cycle** – Inner case retracts into outer case, then screen surface retracts into inner case.

\*\* To order a Ropewalker screen in a specialty surface, the suffix codes should be added to the end of the Matt White XT1000VB part number. (Ex. 150001TA for a 65" Ropewalker screen with the TecVision® CS1000X ALR surface.) NanoPerf surfaces are not available on the Ropewalker. See pages 4-6 for full descriptions and formula codes of all available surfaces.



Screen Diagonal	Ropewalker E Argent White XH1500E, Contrast Grey XH800E, Contrast White XH1100E, Matt White XT1000E, or *Pearl White CH1900E	
	PART	PRICE
<b>16:10 Format</b>		
76"	150057**	\$20072
85"	150058**	20072
94"	150059**	20072
109"	150060**	20072
113"	150061**	20119
123"	150062**	20296
137"	150063**	20519
165"	150064**	21054
189"	150065**	21541
198"	150066**	21809
222"	150067**	22294
255"	150068**	23001
<b>16:9 HDTV Format</b>		
73"	150043**	\$19897
82"	150044**	19897
92"	150045**	19897
100"	150046**	19897
106"	150047**	19897
110"	150048**	20032
119"	150049**	20122
133"	150050**	20362
161"	150051**	20966
184"	150052**	21366
193"	150053**	21633
220"	150054**	22121
248"	150055**	22825
<b>NTSC Video Format</b>		
7'	150070**	\$20289
100"	150071**	20289
10'	150072**	20289
11'	150073**	20289
150"	150074**	20639
15'	150075**	20812
200"	150076**	21269
210"	150077**	21553
220"	150078**	21813
230"	150079**	22006
240"	150080**	22201
250"	150081**	22573
270"	150082**	22978

Screen Diagonal	Ropewalker V Grey XH600V, Matt White XT1000VB, or Pure White XT1300V	
	PART	PRICE
76"	150016**	\$20911
85"	150017**	20911
94"	150018**	20911
109"	150019**	20911
113"	150020**	21039
123"	150021**	21459
137"	150022**	22304
165"	150023**	22885
189"	150024**	23415
198"	150025**	24113
226"	150026**	24773
255"	150027**	25557
<b>16:9 HDTV Format</b>		
73"	150002**	\$20959
82"	150003**	20959
92"	150004**	20959
100"	150005**	20959
106"	150006**	20959
110"	150007**	21719
119"	150008**	21879
133"	150009**	22106
161"	150010**	22593
184"	150011**	23055
193"	150012**	23325
220"	150013**	25168
248"	150014**	25950
<b>NTSC Video Format</b>		
7'	150029**	\$21101
100"	150030**	21101
10'	150031**	21101
11'	150032**	21101
150"	150033**	22443
15'	150034**	22860
200"	150035**	23238
210"	150036**	23526
220"	150037**	25062
230"	150038**	25277
240"	150039**	25570
250"	150040**	25877
270"	150041**	26370

Screen Diagonal	Ropewalker TVX (TecVision® Surfaces)**	
	PART	PRICE
76"	150016**	\$21503
85"	150017**	21578
94"	150018**	21838
109"	150019**	22136
113"	150020**	22373
123"	150021**	23026
137"	150022**	24252
165"	150023**	25720
189"	150024**	27117
198"	150025**	28454
226"	150026**	30108
255"	150027**	32308
<b>16:9 HDTV Format</b>		
73"	150002**	\$21493
82"	150003**	21636
92"	150004**	21793
100"	150005**	21946
106"	150006**	22066
110"	150007**	22920
119"	150008**	23276
133"	150009**	23853
161"	150010**	25153
184"	150011**	26389
193"	150012**	27002
220"	150013**	29969
248"	150014**	32023
<b>NTSC Video Format</b>		
7'	150029**	\$21871
100"	150030**	22213
10'	150031**	22571
11'	150032**	22980
150"	150033**	24780
15'	150034**	26264
200"	150035**	27554
210"	150036**	28427
220"	150037**	30443
230"	150038**	31155
240"	150039**	31971
250"	150040**	32660
270"	150041**	34472

\*Pearl White CH1900E Max 96" Height

# Accessories for Electric Screens

Draper's Low-Voltage controller offers an all-inclusive option. This option can be built into the case at no additional cost. With the ability to build the control in to many of our electric screens, we have you covered for all wall and ceiling installations. The LVC-IV includes the RF receiver, RS232 capabilities, dry contact relays, and a VIC trigger for 4V-28V. Draper projection screens with 110-120V motors are furnished with one control switch (SS-1R). Optional motors shown below can be provided for the additional cost shown. Please specify at time of order by using part number suffix shown below.

## QUIET & BUILT IN LVC-IV MOTOR OPTIONS

Size limitations are listed in charts below.

	Part No. Suffix	PRICE
<b>Quiet Motor:</b> Reduces motor noise by approximately 30%.	<b>Q</b>	185
<b>Low-Voltage Control (LVC-IV) built in with Standard Motor:</b> Eliminates the need for additional external wiring. Adds 1 13/16" to the case length of Premier and Targa Screens. LVC-S Included. (Premier XL and Targa XL case lengths do not change)	<b>U</b>	278
<b>Low-Voltage Control (LVC-IV) built in with Quiet Motor:</b> Building the new LVC-IV into the screen case combined with a quiet motor gives the benefit of having a larger screen with a quiet/Low-Voltage control configuration. LVC-S included.	<b>QU</b>	463

To order a screen with one of these optional motors instead of standard motor, add the part number suffix (above) after the screen part number.  
Example: Access E – 10' diagonal NTSC format, Matt White XT1000E with optional Quiet Motor: Part number 139019Q.

## SPECIAL MOTOR AVAILABILITY AND SIZE LIMITATIONS

Screen Model	Quiet Motor (Q)	Built-In LVC-IV (U)	Quiet Motor with Built-In LVC-IV (QU)
Access FIT E and V	All Sizes	See Chart	All Sizes
Access E and V	See Chart	All Sizes	All Sizes
Access XL E and V	N/A	All Sizes	N/A
Ultimate Access E and V	All Sizes	All Sizes	All Sizes
Ultimate Access XL E and V	N/A	All Sizes	N/A
Silhouette E and V	All Sizes	All Sizes	All Sizes
Premier & Premier XL	See Chart	All Sizes	See Chart
Targa & Targa XL	See Chart	All Sizes	See Chart

## QUIET MOTOR SIZE LIMITATIONS (Q, AND QU)

Screen Type	AV	NTSC	HDTV	16:10
Tab Tensioned Screens	120" x 120"	150"	161"	165"
Tab Tensioned with TecVision® Surfaces	96" x 120"	150"	133"	137"
Non-Tab Tensioned with OptiView Surfaces	144" x 144"	200"	184"	189"

## OPTIONAL CONTROLS FOR MOTORIZED SCREENS

Control	Model Names	Part No.	PRICE
<b>110-120V Controls</b>			
Replacement single station wall switch (Black/Silver)	SS-1R (Standard)	121001	\$72
Replacement single station wall switch (White Decorator)	SS-1R (White)	121102	75
<b>*Low-Voltage Control (24v)</b>			
L.V. control module, no switches	LVC-IV	121222	\$248
Single station, L.V. control combo	LVC-IV & LVC-S	121223	298
2-station L.V. control combo	LVC-IV & 2 LVC-S	121224	347
Additional L.V. control stations	LVC-S	121225	70
LVC-S with locking cover plate		121232	150
RF Wireless Transmitter	WRT	121226	80
<b>*Infrared Remote Transmitter/Receiver</b>			
Extra IR remote Transmitter	IRT	121227	98
Extra IR remote Transmitter	IRT	121228	80
L.V. control with RF Wireless Transmitter	LVC-IV/WRT Kit	121233	347
L.V. control with IR Remote Transmitter	LVC-IV/IRT Kit	121234	347

\*Note—You must have Low-Voltage control module (LVC-IV) to use RF or IR wireless control. IR Wireless receiver plugs into LVC-IV.

### Key Operated Switches

Power supply switch (on-off)	KS-1	121017	\$98
Power supply and single station switch combo	KS-1/SS-1R	121032	168
3-position (up-off-down) key control switch (maintained)	KS-3	121018	110
3-position (up-off-down) key control switch (momentary)	SP-KSM	121022	110
Switch with locking cover plate	SP-KPS-I	121019	130

### Replacement Motors

Targa, Targa XL, Premier, Premier XL, Access E & V, Salara, & Silhouette			\$380
Rolleramic (through 12' x 12')			732
Rolleramic (over 12' x 12')			2099
Paragon			775

Replacement motors for other models available by request. Replacements for quiet and low voltage motors available at additional cost.

### 220V, 50HZ Motors

220V Standard and Quiet Motors available by request

### Networking Communication

Ethernet to Serial Bridge	LS101	121276	\$797
Network Serial Communication Kit	LVC-IV & LS101 Kit	121277	1047

SS-1R



LVC-IV



LVC-S



WRT



IRT



SP-KPS-I



KS-1



KS-3, SP-KSM



**PLEASE NOTE**—Most electric screens (except Salara/Plug & Play) are furnished with one 110-120v control switch (SS-1R). The SS-1R, and many optional controls, are packaged separately but shipped inside the same carton as the screen. BE SURE TO REMOVE THE CONTROLS BEFORE DISCARDING THE SHIPPING CARTON! When shipped separately, one item ships parcel service.

# Accessories for Electric Screens

## MOUNTING BRACKETS

	For use with:	Part No. (White Finish)	Part No. (Black Finish)	PRICE (Pair)	Ship Wt. /lbs.	Freight Class
<b>Non-Adjustable Wall Brackets</b>						
6" Extension	Targa & Premier	227212	227213	\$26	2	50 P
6" Extension	Silhouette	227225	227227	26	3	50 P
10" / 14" Extension	Silhouette	227226	227228	36	4	50 P
10" / 14" Extension	Premier, Targa	227214	227215	36	4	50 P
<b>Floating Screen Brackets</b>						
For floating wall/ceiling mounting	Targa & Premier	227025	227024	\$100	11	50 P

### EXTRA DROP (PER SQUARE FOOT)

Extra Drop may increase case length for Tab-Tensioned projection screens.

	PRICE
All OptiView, OptiFlex, CineFlex, ClearSound, and TecVision® Surfaces:	\$7.00

Extension Brackets and Floating Screen Brackets are not compatible with Premier XL or Targa XL.

## OPTIONAL MOTORS (ILT)— QUIET, PLUG & PLAY, AND BUILT IN LOW-VOLTAGE

Size limitations are listed in charts below.

	Part No. Suffix	PRICE
<b>Motor with built-in Low-Voltage Controller</b>		
Eliminates the need for an external Low-Voltage control module. Price includes wall switch to operate screen and set limit switches, plus 25' cable.	<b>L</b>	\$278
<b>Quiet Motor with built-in Low-Voltage Controller</b>		
Combines the benefits of quiet operation and Low-Voltage control and eliminates the need for an external Low-Voltage control module. Price includes wall switch to operate screen and set limit switches, plus 25' cable.	<b>QL</b>	463
<b>Plug &amp; Play Motor with built-in Low-Voltage Controller</b>		
Features a 10' power cord that plugs into a standard 110V wall outlet. Built-in Low-Voltage Controller eliminates the need for an external Low-Voltage control module. Price includes wall switch to operate screen and set limit switches.	<b>LP</b>	298
<b>Quiet Plug &amp; Play Motor with built-in Low-Voltage Controller</b>		
Adds the convenience of a Plug & Play motor to Draper's Quiet Motor with built-in Low-Voltage Controller. Features a 10' power cord that plugs into a standard 110V wall outlet. Price includes wall switch to operate screen and set limit switches.	<b>QLP</b>	483

Draper projection screens with 110–120V motors are furnished with one control switch (SS-1R). Optional motors shown below can be provided for the additional cost shown. Please specify at time of order by using part number suffix shown above.

To order a screen with one of these optional motors instead of the standard motor, add the part number suffix above after the screen part number. Example: Access FIT E – 10' diagonal NTSC format, Matt White XT1000E with optional Quiet Motor with Built-In Low-Voltage Controller: Part number 139019QL.

**Motor Options**—These motors offer all the features of the motors on page 35, and the limits may be set from special wall switch provided.

## SPECIAL MOTOR AVAILABILITY AND SIZE LIMITATIONS

Screen Model	Motor with Built-In Low-Voltage Control (L)	Quiet Motor with Built-In Low-Voltage Control (QL)	Plug & Play Motor with Built-In Low-Voltage Controller (LP)	Quiet Plug & Play Motor with Built-In Low-Voltage Controller (QLP)
Access FIT E & V	All Sizes	See Chart	N/A	N/A
Access E & V	All Sizes	See Chart	N/A	N/A
Access XL E & V	All Sizes	N/A	N/A	N/A
Ultimate Access E & V	N/A	N/A	N/A	N/A
Ultimate Access XL E & V	N/A	N/A	N/A	N/A
Silhouette E & V	All Sizes	All Sizes	All Sizes	All Sizes
Premier & Premier XL	All Sizes	See Chart	All Sizes	See Chart
Targa & Targa XL	All Sizes	See Chart	All Sizes	See Chart

## SIZE LIMITATIONS FOR MOTORS W/ BUILT-IN LOW VOLTAGE CONTROLLER (QL, AND QLP)

Screen Type	AV	NTSC	HDTV	16:10
Tab Tensioned Screens	96" x 96"	132"	119"	123"
Tab Tensioned with TecVision® Surfaces	84" x 84"	100"	110"	113"
Access FIT V with TecVision®	ALL	120"	ALL	ALL
Non-Tab Tensioned w/OptiView surfaces	108" x 144"	180"	184"	165"

## OPTIONAL CONTROLS FOR MOTORS (ILT) WITH BUILT-IN LOW-VOLTAGE CONTROLLER (L, LP, QL, AND QLP)

These controls are not compatible with LVC-IV. See page 35 for external LVC-IV and its control options.	Part No.	Price
Additional or Replacement Single Station Low-Voltage Wall Switch with cover plate and 25' cable	121171	\$67
RF Type Wireless Transmitter/Receiver	121167	292
Extra RF Type Wireless Transmitter	121168	178
Infrared Wireless Transmitter Receiver	121169	152
Extra Infrared Transmitter	121170	113
Optional 3 Button Single Station Low-Voltage Wall Switch with locking cover plate and 25' cable	121185	172
Optional 3 Position Single Station Low-Voltage ILT Key Operated Wall Switch (Momentary) and 25' cable	121179	172
Replacement 4 jack splitter	C156.096	60

# Manually Operated Screens

All Draper manually operated screens are carefully assembled and fully tested before packaging to make sure they operate perfectly. A significant benefit of Draper's spring-roller screens is that the opening in the case through which the fabric passes is wider than that of our competitors' screens. This significantly reduces friction between the viewing surface and the lips of the case—the greatest single source of spring-roller screen failure.

## Wall- or Ceiling-Mounted Screens

**Premier C**—This screen offers a perfectly flat viewing surface, thanks to Draper's Tab-Tensioning System, but is raised and lowered by using a detachable crank instead of a motor. Intended for data-graphics, video applications, or short throw projection applications where a motorized screen cannot be used. Pentagonal shaped black steel case. Sizes through 12' wide. Advantages of Tab-Tensioning System on page 8.

**Salara M**—Elliptical extruded aluminum case with domed endcaps and white finish. Floating gunlatch wall brackets grip the screen securely and are barely visible. Sizes through 96" wide. Also available with AutoReturn.

**Silhouette C**—The functional equivalent of the Premier C, housed in a strikingly contemporary white extruded aluminum case. Sizes through 96" wide. Advantages of Tab-Tensioning System on page 8.

**Silhouette M**—Spring-roller operated screen in gently radiused aluminum case with matching die cast aluminum endcaps. White (standard) or black. No exposed fasteners. Sizes through 96" wide. The shape of the future. Also available with AutoReturn.

**Luma 2**—Our largest, most rugged spring-roller operated screen, the Luma 2 is housed in a white (black optional) pentagonal-shaped steel case. All cases are formed of one continuous piece of steel without splices or welds. Sizes through 12' wide. Also available with AutoReturn.

**Luma**—Our most popular spring-roller operated screen. The Luma features a white pentagonal-shaped steel case and is offered in sizes up to and including 96" wide. This attractive screen enjoys strong sales in the commercial and educational markets. Also available with AutoReturn.

## Outdoor Screens

**Nocturne+® C**—Crank-operated, designed for outdoor use on your patio, by your pool deck, or any other outdoor space. Weather- and insect-resistant solid aluminum headbox includes built-in hinge for easy installation and service. Ships standard with cable guides and weighted dowel. Both wall and deck mount cable guide brackets included. Sizes through 132" wide with custom quote.

## Ceiling-Recessed Screens

**Access M**—Spring-roller operated screen with folded steel case for recessed ceiling installation. Flanges around all four sides support acoustical ceiling tile, or serve to trim the opening of any type of ceiling. Case may be installed during "dirty" phase of construction and latching brackets enable installation of screen into case any time thereafter. Sizes through 12' wide. Also available with AutoReturn.

**Access FIT M**—Spring-roller operated screen with "slim" case for recessed ceiling installation. Flanges around all four sides support acoustical ceiling tile, or serve to trim the opening of any type of ceiling. Case may be installed during "dirty" phase of construction and latching brackets enable installation of screen into case any time thereafter. Sizes through 10' wide. Also available with AutoReturn.

## AutoReturn

### AutoReturn roller for Draper manual projection screens

Draper is pleased to offer the AutoReturn feature for our unparalleled line of manual projection screens. In a manual projection screen with AutoReturn, the roller mechanism gently raises the screen surface back into the case with a simple tug on the handle/pull cord. AutoReturn is available on the following screens:

- Salara M - page 42
- Silhouette M - page 41
- Luma - page 43
- Luma 2 - page 44
- Access M - page 39
- Access FIT M - page 39

# Access M Family

Access FIT features a low-profile case to fit in smaller spaces. Hinged door cover makes installation and service easier. Access/M is spring-roller operated screen with white folded steel case, for ceiling-recessed installation. Also available with AutoReturn. Sizes above 70" in height include pull cord.

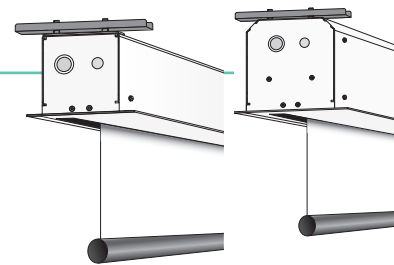

MANUAL SCREENS

## STANDARD SPECS

- **Sizes and Formats:** Custom sizes by quotation. Custom sizes need to be specified in detail, including extra drop, if desired.
- **Case Dimensions:** Mounting brackets may add to both dimensions, see Submittal in the Technical Documents tab at [www.draperinc.com](http://www.draperinc.com) for details. Extra drop may increase case length: call for dimensions.
- **Black Borders:** NTSC, HDTV, and 16:10 format have image area framed with black on all four sides. Black side borders are available on request for AV format screens.

## OPTIONS

- **Case Options:** For more information on how to order case in advance of screen, see page 39. All ceiling recessed cases can be painted black upon request at an additional \$15.00 per lineal foot.
- **Extra Drop:** Additional drop above image area (specify color—surface color standard for AV format; Black standard for all others). See page 45.
- **Operating Pole:** Aluminum operating pole is a popular option. See page 45.

# Access FIT M

**Case Dimensions 5 1/16" high x 6 7/16" deep including trim flange.** Mounting brackets may add to both dimensions, see Submittal in the Technical Documents tab at [www.draperinc.com](http://www.draperinc.com) for details.

\*These sizes include 12" black drop as standard—NO EXTRA CHARGE!

**Note:** for alternate installation of Access FIT screens, additional set (pair) of brackets is required. Part No. C502.233

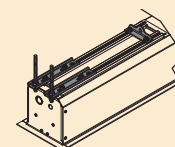

H x W / Diagonal	Image Area	Overall Size	OptiView Surfaces					Case Length	Ship Wt.	Dim Wt.	Freight Class		
			Matt White XT1000E	PRICE	Contrast Grey XH800E	Contrast White XH1100E	Argent White XH1500E					Pearl White CH1900E	PRICE
<b>16:10 Format</b>													
94"	50" x 80"	62" x 83 1/2"	197027	\$1047	197027EC	197027EG	197027EH	197027EJ	\$1100	90"	58	60	85 P+
109"	57 1/2" x 92"	69 1/2" x 96"	197028	1114	197028EC	197028EG	197028EH	197028EJ	1169	102"	67	67	85
113"	60" x 96"	72" x 100"	197029	1170	197029EC	197029EG	197029EH	197029EJ	1229	106"	67	67	85
123"	65" x 104"	69" x 108"	197030	1290	197030EC	197030EG	197030EH	--	1355	114"	77	85	85
137"	72 1/2" x 116"	76 1/2" x 120"	197031	1532	197031EC	197031EG	197031EH	--	1609	126"	87	85	85
<b>16:9 HDTV Format</b>													
92"	45" x 80"	57" x 83 1/2"	197020	\$1047	197020EC	197020EG	197020EH	197020EJ	\$1100	90"	58	60	85 P+
106"	52" x 92"	64" x 96"	197022	1114	197022EC	197022EG	197022EH	197022EJ	1169	102"	77	85	85
110"	54" x 96"	66" x 100"	197023	1170	197023EC	197023EG	197023EH	197023EJ	1229	106"	67	85	85
119"	58" x 104"	62" x 108"	197024	1290	197024EC	197024EG	197024EH	--	1355	114"	77	85	85
133"	65" x 116"	69" x 120"	197025	1477	197025EC	197025EG	197025EH	--	1550	126"	94	85	85
<b>4:3 NTSC Video Format</b>													
6'	42 1/2" x 56 1/2"	46 1/2" x 59 1/2"	197013	\$985	197013EC	197013EG	197013EH	197013EJ	\$1035	66"	40	45	85 P+
7'	50" x 66 1/2"	53 1/2" x 69 1/2"	197014	1039	197014EC	197014EG	197014EH	197014EJ	1090	76"	50	51	85 P+
100"	60" x 80"	64" x 83 1/2"	197015	1094	197015EC	197015EG	197015EH	197015EJ	1149	90"	59	60	85 P+
10'	69" x 92"	73" x 96"	197016	1114	197016EC	197016EG	197016EH	197016EJ	1169	102"	68	85	85
11'	78" x 104"	83" x 108"	197017	1450	197017EC	197017EG	197017EH	--	1524	114"	78	85	85
150"	87" x 116"	92" x 120"	197018	1532	197018EC	197018EG	197018EH	--	1609	126"	89	85	85
<b>AV Format</b>													
50" x 50"			197001	\$970	197001EC	197001EG	197001EH	197001EJ	\$1019	56"	39		85 P+
60" x 60"			197002	995	197002EC	197002EG	197002EH	197002EJ	1045	66"	45		85 P+
70" x 70"			197003	1045	197003EC	197003EG	197003EH	197003EJ	1097	76"	52		85 P+
84" x 84"			197004	1102	197004EC	197004EG	197004EH	197004EJ	1157	90"	61		85 P+
72" x 96"			197005	1114	197005EC	197005EG	197005EH	197005EJ	1169	102"	67		85
96" x 96"			197006	1219	197006EC	197006EG	197006EH	197006EJ	1280	102"	78		85
7' x 9'			197007	1280	197007EC	197007EG	197007EH	--	1344	114"	77		85
9' x 9'			197008	1317	197008EC	--	--	--	1382	114"	82		85
8' x 10'			197009	1532	197009EC	197009EG	197009EH	--	1609	126"	88		85
10' x 10'			197010	1602	197010EC	--	--	--	1682	126"	93		85

# Access M

**Case Dimensions 7 3/8" high x 8 1/16" deep including trim flange.** Mounting brackets may add to both dimensions, see Submittal in the Technical Documents tab at [www.draperinc.com](http://www.draperinc.com) for details.

**Note:** for alternate installation of Access M screens, additional set (pair) of brackets is required. Part No. C502.240.

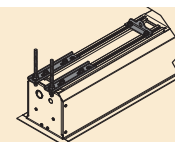

H x W / Diagonal	Image Area	Overall Size	OptiView Surfaces			Case Length	Ship Wt.	Freight Class	
			Matt White XT1000E	PRICE	Contrast Grey XH800E				PRICE
<b>16:10 Format</b>									
165"	87 1/2" x 140"	92 1/2" x 144"	197032	\$1635	197032EC	\$1717	150"	142	85
<b>16:9 HDTV Format</b>									
161"	79" x 140"	84" x 144"	197026	\$1635	197026EC	\$1717	150"	162	85
<b>4:3 NTSC Video Format</b>									
15'	105" x 140"	109" x 144"	197019	\$1794	197019EC	\$1884	150"	142	85
<b>AV Format</b>									
9' x 12'			197011	\$1794	197011EC	\$1884	150"	142	85
12' x 12'			197012	1947	197012EC	2045	150"	162	85

# Access FIT M with AutoReturn

MANUAL SCREENS  
CEILING-RECESSED

**Case Dimensions 5 11/16" high x 6 7/16" deep including trim flange.** Mounting brackets may add to both dimensions, see Submittal in the Technical Documents tab at [www.draperinc.com](http://www.draperinc.com) for details.

**\*These sizes include 12" black drop as standard—NO EXTRA CHARGE!**

H x W / Diagonal	Image Area	Overall Size	OptiView Surfaces							Case Length	Ship Wt.	Dim Wt.	Freight Class
			Matt White XT1000E	PRICE	Contrast Grey XH800E	Contrast White XH1100E	Argent White XH1500E	Pearl White CH1900E	PRICE				
<b>16:10 Format</b>													
94"	50" x 80"	62" x 83 1/2"	197059	\$1134	197059EC	197059EG	197059EH	197059EJ	\$1190	92"	58	60	85 P+
109"	57 1/2" x 92"	69 1/2" x 96"	197060	1200	197060EC	197060EG	197060EH	197060EJ	1260	102"	67	85	85
113"	60" x 96"	72" x 100"	197061	1257	197061EC	197061EG	197061EH	197061EJ	1320	106"	84	85	85
123"	65" x 104"	69" x 108"	197062	1375	197062EC	197062EG	197062EH	--	1444	114"	77	85	85
137"	72 1/2" x 116"	76 1/2" x 120"	197063	1617	197063EC	197063EG	197063EH	--	1699	126"	87	85	85
<b>16:9 HDTV Format</b>													
92"	45" x 80"	57" x 83 1/2"	197052	\$1134	197052EC	197052EG	197052EH	197052EJ	\$1190	90"	58	60	85 P+
106"	52" x 92"	64" x 96"	197054	1200	197054EC	197054EG	197054EH	197054EJ	1260	102"	67	85	85
110"	54" x 96"	66" x 100"	197055	1257	197055EC	197055EG	197055EH	197055EJ	1320	106"	67	85	85
119"	58" x 104"	62" x 108"	197056	1375	197056EC	197056EG	197056EH	--	1444	114"	77	85	85
133"	65" x 116"	69" x 120"	197057	1562	197057EC	197057EG	197057EH	--	1642	126"	96	85	85
<b>4:3 NTSC Video Format</b>													
6'	42 1/2" x 56 1/2"	46 1/2" x 59 1/2"	197045	\$1072	197045EC	197045EG	197045EH	197045EJ	\$1125	66"	41	45	85 P+
7'	50" x 66 1/2"	53 1/2" x 69 1/2"	197046	1124	197046EC	197046EG	197046EH	197046EJ	1180	76"	50	51	85 P+
100"	60" x 80"	64" x 83 1/2"	197047	1180	197047EC	197047EG	197047EH	197047EJ	1239	90"	59	60	85 P+
10'	69" x 92"	73" x 96"	197048	1200	197048EC	197048EG	197048EH	197048EJ	1260	102"	68	85	85
11'	78" x 104"	83" x 108"	197049	1537	197049EC	197049EG	197049EH	--	1614	114"	78	85	85
150"	87" x 116"	92" x 120"	197050	1617	197050EC	197050EG	197050EH	--	1699	126"	89	85	85
<b>AV Format</b>													
50" x 50"			197033	\$1055	197033EC	197033EG	197033EH	197033EJ	\$1109	56"	39	52	85 P+
60" x 60"			197034	1082	197034EC	197034EG	197034EH	197034EJ	1137	66"	45	60	85 P+
70" x 70"			197035	1132	197035EC	197035EG	197035EH	197035EJ	1189	76"	52	67	85 P+
84" x 84"			197036	1189	197036EC	197036EG	197036EH	197036EJ	1249	90"	61	80	85 P+
72" x 96"			197037	1200	197037EC	197037EG	197037EH	197037EJ	1260	102"	67	85	85
96" x 96"			197038	1305	197038EC	197038EG	197038EH	197038EJ	1370	102"	68	85	85
7' x 9'			197039	1367	197039EC	197039EG	197039EH	--	1435	114"	77	85	85
9' x 9'			197040	1404	197040EC	--	--	--	1474	114"	82	85	85
8' x 10'			197041	1617	197041EC	197041EG	197041EH	--	1699	126"	88	85	85
10' x 10'			197042	1687	197042EC	--	--	--	1772	126"	93	85	85

**Note:** for alternate installation of Access FIT screens, additional set (pair) of brackets is required. Part No. C502.233 .

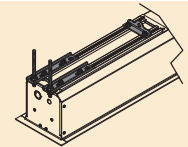

# Access M with AutoReturn

**Case Dimensions 7 3/8" high x 8 1/16" deep including trim flange.** Mounting brackets may add to both dimensions, see Submittal in the Technical Documents tab at [www.draperinc.com](http://www.draperinc.com) for details.

H x W / Diagonal	Image Area	Overall Size	OptiView Surfaces				Case Length	Ship Wt.	Freight Class
			Matt White XT1000E	PRICE	Contrast Grey XH800E	PRICE			
<b>16:10 Format</b>									
165"	87 1/2" x 140"	92 1/2" x 144"	197064	\$1720	197064EC	\$1807	150"	108	85
<b>16:9 HDTV Format</b>									
161"	79" x 140"	84" x 144"	197058	\$1720	197058EC	\$1807	150"	106	85
<b>4:3 NTSC Video Format</b>									
15'	105" x 140"	109" x 144"	197051	\$1880	197051EC	\$1975	150"	111	85
<b>AV Format</b>									
9' x 12'			197043	\$1880	197043EC	\$1975	150"	111	85
12' x 12'			197044	2034	197044EC	2134	150"	127	85

**Note:** for alternate installation of Access M screens, additional set (pair) of brackets is required. Part No. C502.240 .

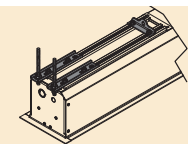

## The Access Family: Case Now, Screen Later.

You can install the case during the "dirty" phase of the construction process and keep the screen safe until you install the projector. Screen (motor-in-roller and attached viewing surface) installs in seconds with preset latching roller brackets and electrical pin connectors. Eliminates job site damage. Screens may be installed in cases up to 20" wider than the standard case lengths shown.

**Cases may be ordered and pre-installed. If ordering case in advance of screen, price of case will be deducted when screen is ordered. Please specify case length at time of order. If you are unsure of future size, please call Draper for suggestions or use printed size information for your most logical choice.**

**Case Options:** All ceiling recessed cases can be painted black upon request at an additional cost.

### Freight Class Key

**Number** LTL freight class  
**P** Parcel Service  
**+** \$15 surcharge (over 48" long)

**Example:** A freight code of 125 P+ indicates a item that may ship as freight class 125 or via parcel service with \$15 surcharge.

# Premier C

This screen offers a perfectly flat viewing surface, thanks to Draper's Tab-Tensioning System (see page 8), but is raised and lowered by using a detachable crank instead of a motor. Pentagonal shaped black steel case with matching endcaps and universal mounting brackets. Detachable crank is polished aluminum.



MANUAL SCREENS

## STANDARD SPECS

- Sizes and Formats:** Custom sizes available by quotation. Custom sizes need to be specified in detail, including extra drop, if desired.
- Case Dimensions:** 5 7/8" H x 5 1/4" D. Extra drop will increase length of case. Black Borders: Image area fully framed with black on all four sides and 12" black drop at top of viewing surface (standard).

## OPTIONS

- Extra Drop:** For additional drop see page 45 (specify color: Black is standard).
- Viewing Surface:** CineFlex CH1200V (CB) rear projection surface, CineFlex White XT700V (CD) front/rear projection surface. ClearSound NanoPerf XT1000V and ClearSound Perf XT900V surfaces are available by quotation. See page 5.

**TECVISION** \*\* To order a screen with a TecVision® surface, the suffix codes should be added to the end of the Matt White XT1000VB part number. (Ex. 200099TA for a 92" screen with the TecVision® CS1000X ALR surface.) See page 6 for full descriptions and formula codes of all available TecVision® surfaces.

H x W / Diagonal	Image Area	OptiFlex Viewing Surfaces				Case Length	Ship Wt./lbs.	Dim Wt./lbs.	Freight Class
		Matt White XT1000VB	Grey XH600V	Pure White XT1300V	PRICE				
<b>16:9 HDTV Format</b>									
92"	45" x 80"	200099	200142	200099FN	\$1864	97 5/8"	64	75	85 P+
106"	52" x 92"	200100	200143	200100FN	1929	110"	72		85
119"	58" x 104"	200150	200152	200150FN	2210	122"	81		85
133"	65" x 116"	200101	200144	200101FN	2422	135"	90		85
161"	79" x 140"	200102	200157	200102FN	2892	160 1/4"	107		85
<b>4:3 NTSC Video Format</b>									
6'	42 1/2" x 56 1/2"	200094	200139	200094FN	\$1452	74"	50	58	85 P+
7'	50" x 66 1/2"	200095	200140	200095FN	1615	84 1/2"	54	65	85 P+
100"	60" x 80"	200096	200141	200096FN	1879	97 5/8"	65		85
10'	72" x 96"	200086	200137	200086FN	1940	115"	73		85
11'	78" x 104"	200097	200155	200097FN	2324	124 1/4"	81		85
150"	87" x 116"	200098	200156	200098FN	2449	136 1/4"	91		85
<b>AV Format</b>									
50" x 50"		200082	200133	200082FN	\$1304	68"	39	54	85 P+
60" x 60"		200083	200134	200083FN	1437	78 3/4"	54	61	85 P+
70" x 70"		200084	200135	200084FN	1709	89"	60	69	85 P+
84" x 84"		200085	200136	200085FN	1930	104 1/4"	65		85
96" x 96"		200087	200138	200087FN	2044	117 3/4"	79		85
7' x 9'		200088	200153	200088FN	2199	128 1/4"	84		85
9' x 9'		200089	200154	200089FN	2519	129 3/4"	88		85
8' x 10'		200090	200090FB	200090FN	2646	141 3/4"	85		85
10' x 10'		200091	200091FB	200091FN	2749	143 1/2"	90		85

# Silhouette C

Crank operated screen housed in a contemporary extruded white aluminum case featuring Draper's Tab-Tensioning System (see page 8). Detachable crank is polished aluminum.

## STANDARD SPECS

- Sizes and Formats:** Custom sizes available by quotation. Custom sizes need to be specified in detail, including extra drop, if desired.
- Case Dimensions:** 6" H x 4 3/4" D. Extra drop will increase length of case.
- Black Borders:** Image area fully framed with black on all four sides and 12" black drop at top of viewing surface (standard).

## OPTIONS

- Options:** White standard, Black option case. Additional drop, see page 45.
- Viewing Surface:** CineFlex CH1200V (CB) rear projection surface and CineFlex White XT700V (CD) front/rear projection surface. ClearSound NanoPerf XT1000V, ClearSound Perf XT900V surfaces are available by quotation. See page 5.

**TECVISION** \*\* To order a screen with a TecVision® surface, the suffix codes should be added to the end of the Matt White XT1000VB part number. (Ex. 201090TA for a 92" screen with the TecVision® CS1000X ALR surface.) See page 6 for full descriptions and formula codes of all available TecVision® surfaces.

H x W / Diagonal	Image Area	OptiFlex Viewing Surfaces				TecVision® Surface		Case Length	Ship Wt./lbs.	Dim Wt./lbs.	Freight Class
		Matt White XT1000VB	Grey XH600V	Pure White XT1300V	PRICE	TecVision®	PRICE				
<b>16:9 HDTV Format</b>											
92"	45" x 80"	201090	201116	201090FN	\$2125	201090**	\$2959	102 3/4"	69	85	
106"	52" x 92"	201091	201117	201091FN	2197	201091**	3304	114 3/4"	95	85	
<b>4:3 NTSC Video Format</b>											
6'	42 1/2" x 56 1/2"	201087	201113	201087FN	\$1654	201087**	\$2209	79 1/4"	44	85 P+	
7'	50" x 66 1/2"	201088	201114	201088FN	1827	201088**	2597	89 1/4"	56	85 P+	
100"	60" x 80"	201089	201115	201089FN	2120	201089**	3232	103 3/4"	66	85	
10'	72" x 96"	201085	201111	201085FN	2194	201085**	3794	119 3/4"	91	85	
<b>AV Format</b>											
50" x 50"		201081	201107	201081FN	\$1494	201081**	--	72 3/4"	49	85 P+	
60" x 60"		201082	201108	201082FN	1642	201082**	--	83 3/4"	44	85 P+	
70" x 70"		201083	201109	201083FN	1925	201083**	--	93 3/4"	60	85 P+	
84" x 84"		201084	201110	201084FN	2174	201084**	--	109"	65	85	
96" x 96"		201086	201112	201086FN	2297	201086**	--	122 1/2"	72	85	





Spring-roller operated screen in gently radiused white aluminum case with matching die cast aluminum endcaps. No exposed fasteners. Also available with AutoReturn. Sizes above 70" in height include pull cord. Viewing surfaces from the OptiView family.

## STANDARD SPECS

- **Sizes and Formats:** Custom sizes available by quotation. Custom sizes need to be specified in detail, including extra drop, if desired.
- **Case Dimensions:** 6" H x 4 3/4" D.
- **Black Borders:** NTSC, HDTV, and 16:10 format have image area framed with black on all four sides. Black side borders are available on request for AV format screens.

\* These sizes include 12" black drop as standard- NO EXTRA CHARGE!

## OPTIONS

- **Case Finish:** White standard or Black option.
- **Extra Drop:** Extra drop above image area, see page 45 (specify color: surface color standard; Black available).

H x W / Diagonal	Image Area	Overall Size	OptiFlex Viewing Surfaces								Case Length	Ship Wt./lbs.	Dim Wt./lbs.	Freight Class
			Matt White XT1000E	PRICE	Contrast Grey XH800E	Contrast White XH1100E	Argent White XH1500E	Pearl White CH1900E	PRICE					
<b>16:10 Format</b>														
67"	35 1/4" x 56 1/2"	47 1/4" x 59 1/2"	202215	\$438	202219	202215EG	202215EH	202215EJ	\$472	62 1/2"	31	45	85 P+	
76"	40" x 64"	52" x 69 1/2"	202216	497	202220	202216EG	202216EH	202216EJ	532	72 1/2"	38	53	85 P+	
85"	45" x 72"	57" x 74"	202217	515	202221	202217EG	202217EH	202217EJ	558	77"	40	62	85 P+	
94"	50" x 80"	62" x 83 1/2"	202218	522	202222	202218EG	202218EH	202218EJ	565	86 1/2"	42	61	85 P+	
109"	57 1/2" x 92"	69 1/2" x 96"	202302	567	202303	202302EG	202302EH	202302EJ	613	99"	50	70	85 P+	
<b>16:9 HDTV Format</b>														
65"	31 3/4" x 56 1/2"	43 3/4" x 59 1/2"	202200	\$438	202206	202200EG	202200EH	202200EJ	\$472	62 1/2"	31	45	85 P+	
73"	36" x 64"	48" x 69 1/2"	202201	497	202207	202201EG	202201EH	202201EJ	532	72 1/2"	38	53	85 P+	
82"	40 1/2" x 72"	52 1/2" x 74"	202202	515	202208	202202EG	202202EH	202202EJ	558	77"	40	62	85 P+	
92"	45" x 80"	57" x 83 1/2"	202209	522	202213	202209EG	202209EH	202209EJ	565	86 1/2"	42	61	85 P+	
100"	49" x 87"	61" x 91"	202306	538	202308	202306EG	202306EH	202306EJ	587	94"	41	70	85 P+	
106"	52" x 92"	64" x 96"	202210	567	202214	202210EG	202210EH	202210EJ	613	99"	51	70	85 P+	
<b>4:3 NTSC Video Format</b>														
6'	42 1/2" x 56 1/2"	46 1/2" x 59 1/2"	202168	\$430	202194	202168EG	202168EH	202168EJ	\$465	62 1/2"	31	49	85 P+	
7'	50" x 66 1/2"	53 1/2" x 69 1/2"	202169	490	202195	202169EG	202169EH	202169EJ	523	72 1/2"	38	54	85 P+	
100"	60" x 80"	64" x 83 1/2"	202170	510	202196	202170EG	202170EH	202170EJ	550	86 1/2"	42	62	85 P+	
10'	69" x 92"	73" x 96"	202171	560	202197	202171EG	202171EH	202171EJ	607	99"	52	75	85 P+	
<b>AV Format</b>														
50" x 50"			202162	\$402	202188	202162EG	202162EH	202162EJ	\$427	52 1/2"	28	38	85 P	
60" x 60"			202163	430	202189	202163EG	202163EH	202163EJ	465	62 1/2"	31	45	85 P+	
70" x 70"			202164	467	202190	202164EG	202164EH	202164EJ	500	72 1/2"	38	53	85 P+	
84" x 84"			202165	498	202191	202165EG	202165EH	202165EJ	540	86 1/2"	42	60	85 P+	
72" x 96"			202166	560	202192	202166EG	202166EH	202166EJ	607	99"	47	69	85 P+	
96" x 96"			202167	580	202193	202167EG	202167EH	202167EJ	628	99"	49	70	85 P+	

# Silhouette M with AutoReturn

See page 37 for a description of the AutoReturn feature.

\*These sizes include 12" black drop as standard—NO EXTRA CHARGE!

H x W / Diagonal	Image Area	Overall Size	OptiFlex Viewing Surfaces								Case Length	Ship Wt./lbs.	Dim Wt./lbs.	Freight Class
			Matt White XT1000E	PRICE	Contrast Grey XH800E	Contrast White XH1100E	Argent White XH1500E	Pearl White CH1900E	PRICE					
<b>16:10 Format</b>														
67"	35 1/4" x 56 1/2"	47 1/4" x 59 1/2"	202231	\$512	202236	202231EG	202231EH	202231EJ	\$545	64 1/8"	31	45	85 P+	
76"	40" x 64"	52" x 69 1/2"	202232	572	202237	202232EG	202232EH	202232EJ	608	74 1/8"	38	53	85 P+	
85"	45" x 72"	57" x 74"	202233	588	202238	202233EG	202233EH	202233EJ	630	78 1/8"	40	62	85 P+	
94"	50" x 80"	62" x 83 1/2"	202234	595	202239	202234EG	202234EH	202234EJ	638	88 1/8"	42	62	85 P+	
109"	57 1/2" x 92"	69 1/2" x 96"	202235	667	202240	202235EG	202235EH	202235EJ	710	100 5/8"	57	70	85 P+	
<b>16:9 HDTV Format</b>														
65"	31 3/4" x 56 1/2"	43 3/4" x 59 1/2"	202287	\$512	202293	202287EG	202287EH	202287EJ	\$545	64 1/8"	31	45	85 P+	
73"	36" x 64"	48" x 69 1/2"	202288	572	202294	202288EG	202288EH	202288EJ	608	74 1/8"	38	52	85 P+	
82"	40 1/2" x 72"	52 1/2" x 74"	202289	588	202295	202289EG	202289EH	202289EJ	630	78 1/8"	40	55	85 P+	
92"	45" x 80"	57" x 83 1/2"	202296	595	202300	202296EG	202296EH	202296EJ	638	88 1/8"	42	61	85 P+	
100"	49" x 87"	61" x 91"	202309	630	202311	202309EG	202309EH	202309EJ	675	95 5/8"	41	66	85 P+	
106"	52" x 92"	64" x 96"	202297	667	202301	202297EG	202297EH	202297EJ	710	100 5/8"	47	69	85 P+	
<b>4:3 NTSC Video Format</b>														
6'	42 1/2" x 56 1/2"	43 3/4" x 59 1/2"	202257	\$502	202281	202257EG	202257EH	202257EJ	\$535	64 1/8"	31	45	85 P+	
7'	50" x 66 1/2"	48" x 69 1/2"	202258	565	202282	202258EG	202258EH	202258EJ	595	74 1/8"	38	52	85 P+	
100"	60" x 80"	52 1/2" x 74"	202259	585	202283	202259EG	202259EH	202259EJ	625	88 1/8"	50	62	85 P+	
10'	69" x 92"	57" x 83 1/2"	202260	657	202284	202260EG	202260EH	202260EJ	703	100 5/8"	52	69	85 P+	
<b>AV Format</b>														
50" x 50"			202251	\$467	202275	202251EG	202251EH	202251EJ	\$490	54 1/8"	28	39	85 P	
60" x 60"			202252	495	202276	202252EG	202252EH	202252EJ	527	64 1/8"	31	45	85 P+	
70" x 70"			202253	538	202277	202253EG	202253EH	202253EJ	573	74 1/8"	38	52	85 P+	
84" x 84"			202254	575	202278	202254EG	202254EH	202254EJ	617	88 1/8"	42	61	85 P+	
72" x 96"			202255	657	202279	202255EG	202255EH	202255EJ	703	100 5/8"	47	69	85 P+	
96" x 96"			202256	690	202280	202256EG	202256EH	202256EJ	735	100 5/8"	50	69	85 P+	

# Salara M

Elliptical extruded aluminum case with domed endcaps and white finish. Floating wall brackets grip the screen securely anywhere along the back of the case, and are barely visible. Sizes 70" in height or above include pull cord. Viewing surfaces from the OptiView family. Wall/Ceiling brackets available for both Salara M and Salara M with AutoReturn C104.066SA (Single Bracket).

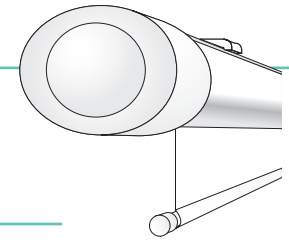

MANUAL SCREENS

## STANDARD SPECS

- Sizes and Formats:** Custom sizes available by quotation. Custom sizes need to be specified in detail, including extra drop, if desired.
- Case Dimensions:** 3 13/16" H x 5 1/16" D.
- Black Borders:** NTSC, HDTV, and 16:10 format have image area framed with black on all four sides. Black side borders are available on request for AV.

## OPTIONS

**Extra Drop:** Extra drop above image area, see page 45 (specify color: surface color is standard for AV format; Black for others).

**\*These sizes include 12" black drop as standard—NO EXTRA CHARGE!**

OptiFlex Viewing Surfaces													
H x W / Diagonal	Image Area	Overall Size	Matt White XT1000E	PRICE	Contrast Grey XH800E	Contrast White XH1100E	Argent White XH1500E	Pearl White CH1900E	PRICE	Case Length	Ship Wt./lbs.	Dim Wt./lbs.	Freight Class
<b>16:10 Format</b>													
67"	35 1/4" x 56 1/2"	47 1/4" x 59 1/2"	137112	\$395	137117	137112EG	137112EH	137112EJ	\$427	67 1/8"	26	40	125 P+
76"	40" x 64"	52" x 69 1/2"	137113	427	137118	137113EG	137113EH	137113EJ	465	77 1/8"	31	45	125 P+
85"	45" x 72"	57" x 74"	137114	450	137119	137114EG	137114EH	137114EJ	498	81 5/8"	33	47	125 P+
94"	50" x 80"	62" x 83 1/2"	137115	465	137120	137115EG	137115EH	137115EJ	512	91 1/8"	35	53	125 P+
109"	57 1/2" x 92"	69 1/2" x 96"	137116	515	137121	137116EG	137116EH	137116EJ	567	103 5/8"	40		125
<b>16:9 HDTV Format</b>													
65"	31 3/4" x 56 1/2"	43 3/4" x 59 1/2"	137043	\$395	137049	137043EG	137043EH	137043EJ	\$427	67 1/8"	26	40	85 P+
73"	36" x 64"	48" x 69 1/2"	137044	427	137050	137044EG	137044EH	137044EJ	465	77 1/8"	31	45	85 P+
82"	40 1/2" x 72"	52 1/2" x 74"	137045	450	137051	137045EG	137045EH	137045EJ	498	81 5/8"	37	47	85 P+
92"	45" x 80"	57" x 83 1/2"	137052	465	137056	137052EG	137052EH	137052EJ	512	91 1/8"	41	53	125 P+
100"	49" x 87"	61" x 91"	137152	490	137154	137152EG	137152EH	137152EJ	538	98 5/8"	43	55	85 P+
106"	52" x 92"	64" x 96"	137053	515	137057	137053EG	137053EH	137053EJ	567	103 5/8"	45		125
<b>4:3 NTSC Video Format</b>													
6'	42 1/2" x 56 1/2"	46 1/2" x 59 1/2"	137006	\$383	137032	137006EG	137006EH	137006EJ	\$420	67 1/8"	26	40	85 P+
7'	50" x 66 1/2"	53 1/2" x 69 1/2"	137007	418	137033	137007EG	137007EH	137007EJ	453	77 1/8"	31	45	125 P+
100"	60" x 80"	64" x 83 1/2"	137008	450	137034	137008EG	137008EH	137008EJ	498	91 1/8"	37	54	125 P+
10'	69" x 92"	73" x 96"	137009	522	137035	137009EG	137009EH	137009EJ	572	103 5/8"	42		125
<b>AV Format</b>													
50" x 50"			137001	\$362	137027	137001EG	137001EH	137001EJ	\$392	57 1/8"	23	34	85 P+
60" x 60"			137002	383	137028	137002EG	137002EH	137002EJ	420	67 1/8"	27	40	85 P+
70" x 70"			137003	407	137029	137003EG	137003EH	137003EJ	443	77 1/8"	32	45	85 P+
84" x 84"			137004	442	137030	137004EG	137004EH	137004EJ	485	91 1/8"	38	54	85 P+
72" x 96"			137040	500	137042	137040EG	137040EH	137040EJ	547	103 5/8"	42		85
96" x 96"			137005	522	137031	137005EG	137005EH	137005EJ	572	103 5/8"	45		85

# Salara M with AutoReturn

See page 37 for a description of the AutoReturn feature.

**\*These sizes include 12" black drop as standard—NO EXTRA CHARGE!**

OptiFlex Viewing Surfaces													
H x W / Diagonal	Image Area	Overall Size	Matt White XT1000E	PRICE	Contrast Grey XH800E	Contrast White XH1100E	Argent White XH1500E	Pearl White CH1900E	PRICE	Case Length	Ship Wt./lbs.	Dim Wt./lbs.	Freight Class
<b>16:10 Format</b>													
67"	35 1/4" x 56 1/2"	47 1/4" x 59 1/2"	137132	\$465	137137	137132EG	137132EH	137132EJ	\$497	67 1/8"	26	40	125 P+
76"	40" x 64"	52" x 69 1/2"	137133	497	137138	137133EG	137133EH	137133EJ	533	77 1/8"	31	45	125 P+
85"	45" x 72"	57" x 74"	137134	523	137139	137134EG	137134EH	137134EJ	568	81 5/8"	35	47	125 P+
94"	50" x 80"	62" x 83 1/2"	137135	538	137140	137135EG	137135EH	137135EJ	582	91 1/8"	37	54	125 P+
109"	57 1/2" x 92"	69 1/2" x 96"	137136	597	137141	137136EG	137136EH	137136EJ	643	103 5/8"	38		85
<b>16:9 HDTV Format</b>													
65"	31 3/4" x 56 1/2"	43 3/4" x 59 1/2"	137097	\$465	137103	137097EG	137097EH	137097EJ	\$497	67 1/8"	26	40	125 P+
73"	36" x 64"	48" x 69 1/2"	137098	497	137104	137098EG	137098EH	137098EJ	533	77 1/8"	31	45	125 P+
82"	40 1/2" x 72"	52 1/2" x 74"	137099	523	137105	137099EG	137099EH	137099EJ	568	81 5/8"	35	47	125 P+
92"	45" x 80"	57" x 83 1/2"	137106	538	137110	137106EG	137106EH	137106EJ	582	91 1/8"	37	53	125 P+
100"	49" x 87"	61" x 91"	137155	568	137157	137155EG	137155EH	137155EJ	615	98 5/8"	36		125
106"	52" x 92"	64" x 96"	137107	597	137111	137107EG	137107EH	137107EJ	643	103 5/8"	38		125
<b>4:3 NTSC Video Format</b>													
6'	42 1/2" x 56 1/2"	46 1/2" x 59 1/2"	137066	\$465	137088	137066EG	137066EH	137066EJ	\$497	67 1/8"	26	40	125 P+
7'	50" x 66 1/2"	53 1/2" x 69 1/2"	137067	497	137089	137067EG	137067EH	137067EJ	533	77 1/8"	31	45	125 P+
100"	60" x 80"	64" x 83 1/2"	137068	532	137090	137068EG	137068EH	137068EJ	573	91 1/8"	37	53	125 P+
10'	69" x 92"	73" x 96"	137069	593	137091	137069EG	137069EH	--	640	103 5/8"	42		125
<b>AV Format</b>													
50" x 50"			137061	\$425	137083	137061EG	137061EH	137061EJ	\$448	57 1/8"	23	34	125 P+
60" x 60"			137062	448	137084	137062EG	137062EH	137062EJ	485	67 1/8"	27	40	125 P+
70" x 70"			137063	482	137085	137063EG	137063EH	137063EJ	517	77 1/8"	32	45	125 P+
84" x 84"			137064	510	137086	137064EG	137064EH	137064EJ	555	91 1/8"	38	53	125 P+
72" x 96"			137094	593	137096	137094EG	137094EH	137094EJ	640	103 5/8"	42		125
96" x 96"			137065	612	137087	137065EG	137065EH	137065EJ	657	103 5/8"	45		125

The Luma features a white pentagonal-shaped steel case with matching endcaps that also serve as universal mounting brackets. Also available with AutoReturn. Sizes above 70" in height include pull cord. Viewing surfaces from the OptiView family.



## STANDARD SPECS

- **Sizes and Formats:** Custom sizes available by quotation. Custom sizes need to be specified in detail, including extra drop, if desired.
- **Case Dimensions:** 3 3/4" H x 3 1/4" D.
- **Black Borders:** NTSC, HDTV, and 16:10 format have image area framed with black on all four sides. Black side borders are available on request for AV format screens.

## OPTIONS

**Extra Drop:** Additional drop, see page 45 (specify color: surface color standard for AV format; black for other formats).

**\*These sizes include 12" black drop as standard—NO EXTRA CHARGE!**

H x W / Diagonal	Image Area	Overall Size	OptiFlex Viewing Surfaces		Case Length	Ship Wt./lbs.	Dim Wt./lbs.	Freight Class
			Matt White XT1000E	PRICE				
<b>16:10 Format</b>								
67"	35 1/4" x 56 1/2"	47 1/4" x 59 1/2"	207163	\$202	62 3/8"	19	23	85 P+
76"	40" x 64"	52" x 69 1/2"	207164	214	72 3/8"	17	25	85 P+
85"	45" x 72"	57" x 74"	207165	292	76 7/8"	20	27	85 P+
94"	50" x 80"	62" x 83 1/2"	207166	300	86 3/8"	21	30	85 P+
109"	57 1/2" x 92"	69 1/2" x 96"	207167	340	98 7/8"	26	35	85 P+
<b>16:9 HDTV Format</b>								
65"	31 3/4" x 56 1/2"	43 3/4" x 59 1/2"	207091	\$202	62 3/8"	14	16	85 P+
73"	36" x 64"	48" x 69 1/2"	207092	214	72 3/8"	17	25	85 P+
82"	40 1/2" x 72"	52 1/2" x 74"	207093	292	76 7/8"	20	23	85 P+
92"	45" x 80"	57" x 83 1/2"	207100	300	86 3/8"	22	35	85 P+
100"	49" x 87"	61" x 91"	207205	324	93 7/8"	25	33	85 P+
106"	52" x 92"	64" x 96"	207101	340	98 7/8"	27	35	85 P+
<b>4:3 NTSC Video Format</b>								
6'	42 1/2" x 56 1/2"	46 1/2" x 59 1/2"	207007	\$182	62 3/8"	14	22	85 P+
7'	50" x 66 1/2"	53 1/2" x 69 1/2"	207008	204	72 3/8"	17	25	85 P+
100"	60" x 80"	64" x 83 1/2"	207009	260	86 3/8"	23	30	85 P+
10'	69" x 92"	73" x 96"	207010	300	98 7/8"	28	35	85 P+
<b>AV Format</b>								
50" x 50"			207001	\$142	52 3/8"	13	19	85 P
60" x 60"			207002	156	62 3/8"	15	22	85 P+
70" x 70"			207003	168	72 3/8"	18	25	85 P+
84" x 84"			207004	264	86 3/8"	23	30	85 P+
72" x 96"			207005	300	98 7/8"	25	35	85 P+
96" x 96"			207006	334	98 7/8"	28	36	85 P+

## Luma with AutoReturn

See previous page for more information on the Luma, and page 37 for a description of the AutoReturn feature.

**\*These sizes include 12" black drop as standard—NO EXTRA CHARGE!**

H x W / Diagonal	Image Area	Overall Size	OptiFlex Viewing Surfaces		Case Length	Ship Wt./lbs.	Dim Wt./lbs.	Freight Class
			Matt White XT1000E	PRICE				
<b>16:10 Format</b>								
67"	35 1/4" x 56 1/2"	47 1/4" x 59 1/2"	207183	\$348	62 3/8"	14	22	85 P+
76"	40" x 64"	52" x 69 1/2"	207184	358	72 3/8"	30		85 P+
85"	45" x 72"	57" x 74"	207185	406	76 7/8"	33		85 P+
94"	50" x 80"	62" x 83 1/2"	207186	412	86 3/8"	35		85 P+
109"	57 1/2" x 92"	69 1/2" x 96"	207187	478	98 7/8"	37		85 P+
<b>16:9 HDTV Format</b>								
65"	31 3/4" x 56 1/2"	43 3/4" x 59 1/2"	207146	\$348	62 3/8"	14	16	85 P+
73"	36" x 64"	48" x 69 1/2"	207147	358	72 3/8"	17	22	85 P+
82"	40 1/2" x 72"	52 1/2" x 74"	207148	406	76 7/8"	20	23	85 P+
92"	45" x 80"	57" x 83 1/2"	207155	412	86 3/8"	22	23	85 P+
100"	49" x 87"	61" x 91"	207208	464	93 7/8"	25		85 P+
106"	52" x 92"	64" x 96"	207156	478	98 7/8"	26	35	85 P+
<b>4:3 NTSC Video Format</b>								
6'	42 1/2" x 56 1/2"	46 1/2" x 59 1/2"	207116	\$288	62 3/8"	14	16	85 P+
7'	50" x 66 1/2"	53 1/2" x 69 1/2"	207117	312	72 3/8"	17	25	85 P+
100"	60" x 80"	64" x 83 1/2"	207118	376	86 3/8"	20	30	85 P+
10'	69" x 92"	73" x 96"	207119	432	98 7/8"	30	35	85 P+
<b>AV Format</b>								
50" x 50"			207110	\$266	52 3/8"	12		85 P
60" x 60"			207111	278	62 3/8"	14	17	85 P+
70" x 70"			207112	298	72 3/8"	18	25	85 P+
84" x 84"			207113	392	86 3/8"	23		85 P+
72" x 96"			207114	432	98 7/8"	26		85 P+
96" x 96"			207115	486	98 7/8"	28		85 P+

**Freight Class Key**

**Number** LTL freight class  
**P** Parcel Service  
**+** \$15 surcharge (over 48" long)

**Example:** A freight code of 125 P+ indicates a item that may ship as freight class 125 or via parcel service with \$15 surcharge.



Crank-operated, designed for outdoor use on your patio, by your pool deck, or any other outdoor space. Weather- and insect-resistant solid aluminum headbox includes built-in hinge for easy installation and service. Ships standard with cable guides and weighted dowel. Both wall and deck mount cable guide brackets included. Choose the Nocturne® E for motorized operation. Viewing surfaces from the OptiView and ClearSound families.

### STANDARD SPECS

- **Sizes and Formats:** Custom sizes available by quotation. Custom sizes need to be specified in detail, including extra drop, if desired.
- **Case Dimensions:** 3 5/8" H x 3 5/8" D.
- **Black Borders:** Image area framed with black on all four sides.

### OPTIONS

- **Finish Options:** Headbox and exposed hardware standard in white. Also available in Silver, Ivory, Bronze, or Black. Custom powder coated colors available.
- **Extra Drop:** Additional drop above image (specify color—black standard; surface color available). See above.
- **Viewing Surface:** Surfaces from the ClearSound family are available by quotation—Contact Draper or see page 5 for details.

OptiFlex Viewing Surfaces						
H x W / Diagonal	Image Area	Matt White XT1000E	Contrast Grey XH800E	PRICE	Case Length	Dim Wt./lbs. Freight Class
<b>16:10 Format</b>						
94"	50" x 80"	200519	200520	\$1092	86 7/8"	64 85 P+
102"	54" x 87"	200521	200522	1147	94 3/8"	70 85 P+
109"	57 1/2" x 92"	200523	200524	1182	99 3/8"	85
113"	60" x 96"	200525	200526	1217	103 3/8"	85
123"	65" x 104"	200527	200528	1305	111 3/8"	85
137"	72 1/2" x 116"	200529	200530	1467	123 3/8"	85
<b>16:9 HDTV Format</b>						
65"	31 3/4" x 56 1/2"	200501	200502	\$965	62 1/8"	49 85 P+
73"	36" x 64"	200503	200504	1015	72 1/8"	55 85 P+
82"	40 1/2" x 70"	200505	200506	1044	77 3/8"	58 85 P+
92"	45" x 80"	200507	200508	1087	86 7/8"	64 85 P+
100"	49" x 87"	200509	200510	1145	94 3/8"	70 85 P+
106"	52" x 92"	200511	200512	1175	99 3/8"	85
110"	54" x 96"	200513	200514	1212	103 3/8"	85
119"	58" x 104"	200515	200516	1294	111 3/8"	85
133"	65" x 116"	200517	200518	1482	123 3/8"	85
<b>4:3 NTSC Video Format</b>						
6'	42 1/2" x 56 1/2"	200531	200532	\$960	62 1/8"	49 85 P+
7'	50" x 66 1/2"	200533	200534	1015	72 1/8"	55 85 P+
100"	60" x 80"	200535	200536	1087	86 7/8"	64 85 P+
10'	69" x 92"	200537	200538	1244	99 3/8"	85
11'	78" x 104"	200539	200540	1329	111 3/8"	85
150"	87" x 116"	200541	200542	1390	123 3/8"	85

**\*Sizes listed below include 12" black drop- NO EXTRA CHARGE!**

**16:10 Format**  
94", 102", 109", 113"

**16:9 Format**  
65", 73", 82", 92", 100", 106", 110"

## Accessories for Manual Screens

Accessory	For use with:	Part No. (White Finish)	Part No. (Black Finish)	PRICE	Shipping Wt. (kg)	Freight Class
<b>Adjustable Wall Brackets</b>						
18-24" Extension	Luma, Luma 2 to 8' wide	227216	227217	\$44	6	50 P
<b>Non-Adjustable Wall Brackets</b>						
6" Extension	Luma, & Luma 2	227212	227213	\$26	2	50 P
6" Extension	Silhouette	227225	227227	26	3	50 P
10/14" Extension	Luma, Luma 2 to 8' wide	227214	227215	36	4	50 P
10/14" Extension	Silhouette	227226	227228	36	4	50 P
<b>Floating Screen Brackets</b>						
For flexible wall/ceiling mounting	Luma 2	227025	227024	\$105	11	50 P
Accessory	For use with:	Part No. (Silver Finish)	PRICE	Shipping Wt. (kg)	Freight Class	
<b>T-Bar Twist Clips</b>						
Price per pair	Luma to 70" wide	227016	\$18	1	50 P	
<b>Magnetic Keystone Eliminator</b>						
	Manual screens with pull cord/bail	227023	\$7	1	77.5 P	
<b>Aluminum Operating Pole</b>						
4' length	All models	227008	\$26	5	85 P	
6' length	All models	227010	34	6	85 P+	
<b>Extra Drop (Price per square foot, selected manual screens)</b>						
<b>Extra Drop for All Viewing Surfaces</b>				\$7		

*Note: Extra Drop may increase case length for Tab Tensioned projection screens.*

# Replacement Viewing Surfaces

For all roller-operated non-tensioned screens. Specify model when ordering. Surfaces ship with tape for attachment to roller; dowel not included. Viewing surfaces from the OptiView family. NTSC, HDTV, and 16:10 format surfaces have black borders on all four sides.

**\*These sizes include 12" black drop as standard—NO EXTRA CHARGE!**

MANUAL SCREENS

OptiView Surfaces				
H x W / Diagonal	Image Area	Overall Size	Matt White XT1000E	Contrast Grey XH800E, Contrast White XH1100E, Argent White XH1500E, or Pearl White CH1900E
			PRICE	PRICE
<b>16:10 Format</b>				
70**	37" x 56 1/2"	49" x 59 1/2"	\$127	\$159
76**	40" x 64"	52" x 69 1/2"	135	169
85**	45" x 72"	57" x 74"	187	227
94**	50" x 80"	62" x 83 1/2"	209	251
103**	54 1/2" x 87"	66 1/2" x 91"	219	259
109**	57 1/2" x 92"	69 1/2" x 96"	227	272
113**	60" x 96"	72" x 100"	311	372
123"	65" x 104"	69" x 108"	394	468
137"	72 1/2" x 116"	76 1/2" x 120"	484	561
165"	87 1/2" x 140"	87 1/2" x 144"	621	701
<b>16:9 HDTV Format</b>				
65**	31 3/4" x 56 1/2"	43 3/4" x 59 1/2"	\$127	\$159
73**	36" x 64"	48" x 69 1/2"	135	169
82**	40 1/2" x 72"	52 1/2" x 74"	187	227
92**	45" x 80"	57" x 83 1/2"	209	251
100**	49" x 87"	61" x 91"	219	259
106**	52" x 92"	64" x 96"	227	272
110**	54" x 96"	66" x 100"	311	372
119"	58" x 104"	62" x 108"	394	468
133"	65" x 116"	69" x 120"	484	561
161"	79" x 140"	84" x 144"	621	701
<b>4:3 NTSC Video Format</b>				
6'	42 1/2" x 56 1/2"	46 1/2" x 59 1/2"	\$127	\$159
7'	50" x 66 1/2"	53 1/2" x 69 1/2"	135	169
100"	60" x 80"	64" x 83 1/2"	209	251
10'	69" x 92"	73" x 96"	227	272
11'	78" x 104"	83" x 108"	394	468
150"	87" x 116"	92" x 120"	484	561
15'	105" x 140"	109" x 144"	621	701
200"	118" x 158"	123" x 162"	952	1062
20'	141" x 188"	146" x 192"	1167	1303
250"	148" x 198"	153" x 202"	1416	1568
25'	177" x 236"	182" x 240"	1847	2031
<b>AV Format</b>				
40" x 40"			\$65	\$84
50" x 50"			75	97
60" x 60"			84	115
70" x 70"			94	130
84" x 84"			165	209
72" x 96"			187	230
96" x 96"			209	254
7' x 9'			351	421
9' x 9'			412	484
8' x 10'			446	523
10' x 10'			516	593
9' x 12'			578	660
12' x 12'			673	748
10' 6" x 14'			908	1024
14' x 14'			1024	1126
12' x 16'			1126	1258
16' x 16'			1258	1384
13' 6" x 18'			1361	1516
18' x 18'			1558	1712
15' x 20'			1785	1961
20' x 20'			1991	2168

### Freight Class Key

**Number** LTL freight class  
**P** Parcel Service  
**+** \$15 surcharge  
 (over 48" long)

**Example:** A freight code of 125 P+ indicates a item that may ship as freight class 125 or via parcel service with \$15 surcharge.

# Fixed Projection Screens

The primary advantage of Fixed Projection Screens is that the screen surface is perfectly flat, which provides excellent image quality and a great choice for short throw and ultra-short throw projectors. Screens of this type are permanently installed on the wall, and do not roll up into a headbox.

**Cineperm**—The Cineperm consists of a 1" tubular aluminum frame, which assembles without tools using slip fittings. It is permanently-mounted to the wall and has a snap-on viewing surface. The Cineperm is offered in a wide range of standard sizes and can be manufactured in virtually any custom size. Large sizes may require truss construction.

**Clarion**—The Clarion's aluminum frame forms an attractive 2" border, for a clean, theatre-like appearance. The standard frame color is black; Vel-Tex, a black, velvety textile covering is a recommended option that cuts reflection and conceals all trace of joints in the frame. Fabric attaches without snaps for quick assembly and a perfectly smooth viewing surface. This screen can also be curved.

**Onyx**—The Onyx has a 4" wide, beveled trim frame and a proprietary adjustable surface tensioning system that keeps the viewing surface perfectly flat, with no puckering. No snaps—assembles easily in minutes. The frame is wider to handle overscan, and provides up to 1 1/2" of horizontal or vertical viewing surface tension adjustment. Black painted aluminum frame is standard; Vel-Tex, a black, velvety textile covering, is a recommended option that cuts reflection and conceals all trace of joints in the frame. The Onyx enjoys a particularly good following in the home theatre market. This screen can also be curved.

**ShadowBox Clarion**—This product utilizes a 1 1/2" tubular aluminum frame painted flat black. The viewing surface attaches to the back side of the frame. Hence, the frame is visible and serves as a black border around the perimeter of the image area. Vel-Tex black, velvety textile covering, is a recommended option. This screen can also be curved.

**Edgeless Clarion**—The viewing surface of this product wraps completely around the frame and attaches to the back side. The Edgeless Clarion does not have a border of any kind—from the audience side you see only a solid screen surface. This screen can also be curved.

**Profile+** —The Profile+ creates the clean, high tech look of a flat panel screen on your wall—but in larger sizes that are only possible with projection. Its slender frame is less than 5/8" wide and 1 1/2" deep. Features Draper's proprietary surface tensioning system to keep the viewing surface perfectly flat with no puckering. Also available as a borderless product.

**Lace & Grommet** —This projection screen is versatile, wall mounted, and ideal for use in blending, multiformat, and curved applications. It includes a 3" powder coated aluminum frame (black standard) and unique wall mounting brackets used for either flat or curved applications.

**Fixed Projection Screens** ship K.D. (knocked-down) with viewing surface rolled on a core. Only by request will Draper ship a fixed screen assembled. Assembled screens ship in crates and cannot be shipped parcel service. Contact Draper for crate and freight estimate.

## Curved Frame Choices

Draper offers Onyx, Clarion, ShadowBox Clarion, Edgeless Clarion, and Lace & Grommet projection screens with factory-curved extruded aluminum frames featuring Vel-Tex. Custom radii available. See page 48.

FIXED SCREENS

## Screen Fabric Only

### Cut to size

Prices per square foot, based on overall size, no hem, no black border.

Prices per square foot	PRICE
<b>OptiView (Self-Supporting)</b>	
Contrast Grey XH800E	\$ 8.90
Matt White XT1000E	6.90
Contrast White XH1100E	8.90
Argent White XH1500E	8.90
Pearl White CH1900E	8.90
<b>OptiFlex (Flexible)</b>	
Grey XH600V	\$ 9.20
Matt White XT1000V	7.40
Pure White XT1300V	8.90
<b>CineFlex (Rear/Dual Projection)</b>	
CineFlex White XT700V	\$ 14.70
CineFlex CH1200V	14.70
<b>ClearSound (Acoustically Transparent)</b>	
ClearSound NanoPerf XT1000V	\$32.70
ClearSound Perf XT900V	32.70
ClearSound Grey Weave XH600E	33.20
ClearSound White Weave XT900E	33.20
<b>Chroma Key</b>	
Chroma Key Green (Cineperm Only)	\$12.10

## Custom Size Screens

Fixed Screens are available in almost any custom size. Call Draper for help planning your project.

# Curved Frame Screens

## Why Curved?

Curved projection screens offer several key advantages over flat projection screens. A curved screen helps offset pincushion distortion from a horizontal expansion lens, and also wraps the image around your periphery more than a flat screen for greater engagement with your projected image. In addition, the curved image is subject to less ambient reflected light from your room, while your projector's light is more accurately reflected by the perfectly smooth viewing surface for an ideal picture.

## Curvature

The curve is defined by its radius in feet. Draper's curved screens are available with a standard radius of 40'. Custom radii are available—call Draper for consultation.

## Size Ranges

Curved Onyx is available in sizes up to 19' wide.

Curved Clarion is available in sizes up to 13' wide.

Curved ShadowBox Clarion is available in sizes up to 16' wide.

Curved Edgeless Clarion is available in sizes up to 30' wide.

Curved Lace & Grommet is available in sizes up to 100' wide.

Custom sizes are available—contact Draper for details.

## Mounting Brackets

All standard and larger curved Onyx or Clarion screens include a set of mounting brackets: two brackets to attach the center of the curve to the wall at the top and bottom, and two extension brackets to attach the sides. For custom curves and special applications, floor or ceiling brackets may be needed. Call Draper for consultation or custom mounting requirements.

## How to Order

Choose your screen: Clarion (page 51) or Onyx (page 54) projection screen. After the 6-digit part number shown for the screen of your choice, add the letter "C" plus the radius in feet.

For example, if you choose a 148" diagonal Scope format Clarion screen with a Matt White XT1000V viewing surface, and you would like a 40' radius curve, the part number would become 252172C40.

## Veltex

Draper is proud to offer curved Clarion and Onyx projection screens featuring Vel-Tex covered extruded aluminum frames.

## Planning Sheet

Download and complete a planning sheet to collect and confirm your ordering details.

Download a planning sheet at the following address:

[www.draperinc.com/go/CurvedScreens.htm](http://www.draperinc.com/go/CurvedScreens.htm)

Planning sheet required with purchase order.

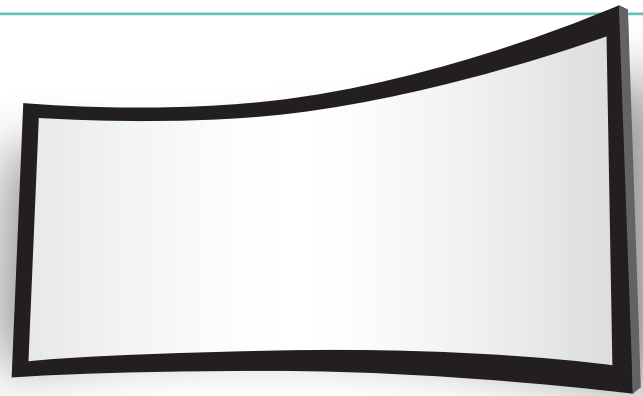

## Understanding Radii

Draper curved projection screens are offered with a variety of radii available, including our standard 40' radius. Imagine a circle with a 40' radius (the distance from the center of the circle to a point on the circle). The curvature of your projection screen will match a line segment of proportionate length cut from the circle.

The smaller the radius, the more curve a screen will have. The appropriate radius of your screen will be determined by several factors—contact Draper for assistance.

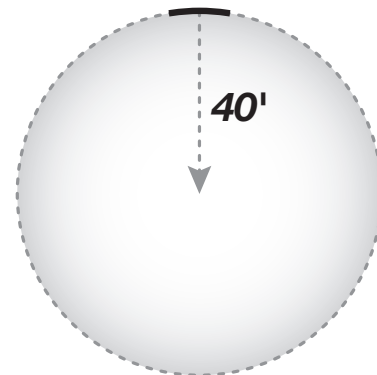

## Curved Frame Clarion and Onyx

Add the appropriate price below to the standard Clarion prices on page 51 or Onyx prices on page 54.

Vel-Tex will be added to all curved screens if it is not already included in the part number. Dealer Net \$135.

Frame Width of original screen	PRICE
≤ 72"	\$760
72 1/8"–84"	854
84 1/8"–96"	950
96 1/8"–108"	1045
108 1/8"–120"	1140
120 1/8"–132"	1235
132 1/8"–144"	1330
144 1/8"–156"	1425
<hr style="border-top: 1px dashed #000;"/>	
156 1/8"–168"	1519
168 1/8"–180"	1615
180 1/8"–192"	1710
192 1/8"–204"	1805
204 1/8" - 216"	1899
216 1/8" - 228"	1995

\*Curved Clarion available up to 13' wide.

# Custom Curved Screens

Lace & Grommet, Edgeless Clarion, and ShadowBox Clarion can also be curved. Please call Draper for pricing and details.

### Example pricing:

If you choose a 106" Onyx with Vel-Tex (Part number 253288), which has an overall width of 100", the pricing would be:

<b>Onyx cost:</b>	\$1,785
<b>+ Curve cost:</b>	\$1,045
<b>Total cost:</b>	\$2,830



# Cineperm

The Cineperm consists of a 1" tubular aluminum frame, which assembles without tools using slip fittings. It is permanently mounted to the wall and has a snap-on viewing surface. Mounting fasteners not provided.

- **Black Borders:** Snap-on viewing surfaces have 2" black vinyl borders.
- **Options:** Custom sizes available by quotation. CineFlex White XT700V front/rear projection surface is also available at the same price as CineFlex CH1200V. See page 5 for viewing surface details. When ordering these surfaces, use the CineFlex CH1200V part number followed by the appropriate suffix: CD for CineFlex White XT700V.

Truss-style construction includes a 6" border and is required for flown installations. Standard Cineperm cannot be flown. Truss Cineperm Fly bracket is required. See page 50 for details.

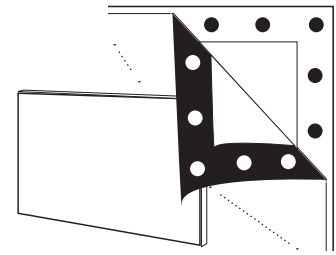

**\*This size requires truss-style construction. Price listed reflects truss-style construction.**

Nom. Diag.	Image Area	Overall Size	OptiFlex Surfaces				Ship Wt./lbs.	Dim Wt./lbs.	Freight Class	
			Matt White XT1000V	Pure White XT1300V	PRICE	Grey XH600V				PRICE
<b>16:10 Format</b>										
67"	35 1/4" x 56 1/2"	39 1/4" x 60 1/2"	251060	251060FN	\$557	251068	\$617	19	32	85 P+
76"	40" x 64"	44" x 68"	251061	251061FN	592	251069	655	20	39	85 P+
85"	45" x 72"	49" x 76"	251062	251062FN	680	251070	755	21	39	85 P+
94"	50" x 80"	54" x 84"	251063	251063FN	777	251071	865	22	43	85 P+
109"	57 1/2" x 92"	61 1/2" x 96"	251064	251064FN	955	251072	1062	23	47	85 P+
113"	60" x 96"	64" x 100"	251139	251139FN	982	251140	1089	26	51	85 P+
123"	65" x 104"	69" x 108"	251065	251065FN	1079	251073	1197	26	53	85 P+
137"	72 1/2" x 116"	76 1/2" x 120"	251066	251066FN	1150	251074	1279	30	55	85 P+
165"	87 1/2" x 140"	91 1/2" x 144"	251067	251067FN	1392	251075	1545	35	57	85 P+
<b>16:9 HDTV Format</b>										
65"	31 3/4" x 56 1/2"	35 3/4" x 60 1/2"	250124	250124FN	\$557	250130	\$617	19	32	85 P+
73"	36" x 64"	40" x 68"	250125	250125FN	592	250131	655	20	39	85 P+
82"	40 1/2" x 72"	44 1/2" x 76"	250126	250126FN	680	250132	755	20	40	85 P+
92"	45" x 80"	49" x 84"	250022	250022FN	777	250092	865	22	43	85 P+
100"	49" x 87"	53" x 91"	251121	251121FN	844	251124	937	24	47	85 P+
106"	52" x 92"	56" x 96"	250023	250023FN	955	250093	1062	25	49	85 P+
110"	54" x 96"	58" x 100"	251127	251127FN	982	251130	1089	26	51	85 P+
119"	58" x 104"	62" x 108"	250120	250120FN	1079	250123	1197	26	53	85 P+
133"	65" x 116"	69" x 120"	250024	250024FN	1150	250094	1279	27	55	85 P+
161"	79" x 140"	83" x 144"	250025	250025FN	1392	250095	1545	34	57	85 P+
193"	95" x 169"	99" x 173"	251109	251109FN	1747	251112	1939	45	58	85 P+
220"	108" x 192"	112" x 196"	251115	251115FN	2042	251118	2270	54		85
<b>4:3 NTSC Video Format</b>										
6"	43" x 57"	47" x 61"	250011	250011FN	\$525	250084	\$583	24	31	85 P+
6' 6"	47" x 63"	51" x 67"	250012	250012FN	580	250085	645	25	35	85 P+
7' 6"	54" x 72"	58" x 76"	250013	250013FN	697	250086	773	26	37	85 P+
100"	60" x 80"	64" x 84"	250014	250014FN	775	250087	862	28	39	85 P+
10'	72" x 96"	76" x 100"	250005	250005FN	955	250078	1062	30	40	85 P+
11'	78" x 104"	82" x 108"	250016	250016FN	1079	250088	1197	34	43	85 P+
150"	90" x 120"	94" x 124"	250007	250007FN	1150	250080	1279	36	49	85 P+
15'	108" x 144"	112" x 148"	250009	250009FN	1392	250133	1545	43		85
200"	120" x 160"	124" x 164"	250019	250019FN	1687	251058	1870	48		85
240**	144" x 194"	156" x 206"	250020	250020FN	4901	251059	5441	100	107	85 P+
25*	180" x 240"	192" x 252"	250021	250021FN	6520	250021FB	7236	172		85
<b>2.35:1 CinemaScope Format</b>										
115"	45" x 105 3/4"	49" x 109 3/4"	251035FN	251035FN	\$1174	251043	\$1302	22	30	85 P+
132"	52" x 122"	56" x 126"	251036FN	251036FN	1445	251044	1605	26	34	85 P+
148"	58" x 136 1/4"	62" x 140 1/4"	251037FN	251037FN	1597	251045	1775	28	38	85 P+
153"	60" x 141"	64" x 145"	251133FN	251133FN	1760	251134	1954	33	40	85 P+
166"	65" x 152 3/4"	69" x 156 3/4"	251038FN	251038FN	1894	251046	2104	47	41	85 P+

CONTINUED

CHART

FIXED SCREENS



Truss Cineperm is available with TecVision® surfaces in large, custom sizes by quotation. Please call for additional product information and pricing. See page 6 for full descriptions and formula codes of all available TecVision® surfaces.

**Freight Class Key**

**Number** LTL freight class

**P** . . . . . Parcel Service

**+** . . . . . \$15.00 surcharge (over 48" long)

**Example:** a freight code of 125 P+ indicates an item that may ship as freight class 125 or via parcel service with \$15.00 surcharge.

# Cineperm (Continued)

\*This size requires truss-style construction. Price listed reflects truss-style construction.

FIXED SCREENS

Nom. Diag.	Image Area	Overall Size	CineFlex Surface		ClearSound Surfaces					Ship Wt./lbs.	Dim Wt./lbs.	Freight Class
			CineFlex CH1200V	PRICE	ClearSound NanoPerf XT1000V	PRICE	ClearSound White Weave XT900E	ClearSound Grey Weave XH600E	PRICE			
<b>16:10 Format</b>												
67"	35 1/4" x 56 1/2"	39 1/4" x 60 1/2"	251060CB	\$657	251060SC	\$1924	251060SA	251060SB	\$2032	19	32	85 P+
76"	40" x 64"	44" x 68"	251061CB	698	251061SC	1967	251061SA	251061SB	2074	20	39	85 P+
85"	45" x 72"	49" x 76"	251062CB	802	251062SC	2005	251062SA	251062SB	2112	21	39	85 P+
94"	50" x 80"	54" x 84"	251063CB	917	251063SC	2050	251063SA	251063SB	2157	22	43	85 P+
109"	57 1/2" x 92"	61 1/2" x 96"	251064CB	1127	251064SC	2999	251064SA	251064SB	3104	23	47	85 P+
113"	60" x 96"	64" x 100"	251139CB	1159	251139SC	3079	251139SA	251139SB	3187	26	51	85 P+
123"	65" x 104"	69" x 108"	251065CB	1272	251065SC	3627	251065SA	251065SB	3736	26	53	85 P+
137"	72 1/2" x 116"	76 1/2" x 120"	251066CB	1357	251066SC	3742	251066SA	251066SB	3849	30	55	85 P+
165"	87 1/2" x 140"	91 1/2" x 144"	251067CB	1642	251067SC	4943	251067SA	251067SB	5048	35	57	85 P+
<b>16:9 HDTV Format</b>												
65"	31 3/4" x 56 1/2"	35 3/4" x 60 1/2"	251032	\$657	250124SC	\$1885	250124SA	250124SB	\$1992	19	32	85 P+
73"	36" x 64"	40" x 68"	251033	698	250125SC	1929	250125SA	250125SB	2035	20	39	85 P+
82"	40 1/2" x 72"	44 1/2" x 76"	251034	802	250126SC	2024	250126SA	250126SB	2132	20	40	85 P+
92"	45" x 80"	49" x 84"	251022	917	250022SC	2052	250065	250110	2159	22	43	85 P+
100"	49" x 87"	53" x 91"	251126	995	251121SC	2229	251123	251125	2334	24	47	85 P+
106"	52" x 92"	56" x 96"	251023	1127	250023SC	3001	250066	250111	3109	25	49	85 P+
110"	54" x 96"	58" x 100"	251132	1159	251127SC	3081	251129	251131	3189	26	51	85 P+
119"	58" x 104"	62" x 108"	251031	1272	250120SC	3629	250122	250119	3737	26	53	85 P+
133"	65" x 116"	69" x 120"	251024	1357	250024SC	3746	250067	250112	3852	27	55	85 P+
161"	79" x 140"	83" x 144"	251025	1642	250025SC	4944	250068	250113	5049	34	57	85 P+
193"	95" x 169"	99" x 173"	251114	2062	251109SC	5586	251111	251113	5694	45	58	85 P+
220"	108" x 192"	112" x 196"	251120	2410	--	--	251117	251119	6071	54		85
<b>4:3 NTSC Video Format</b>												
6'	43" x 57"	47" x 61"	251011	\$620	250011SC	\$1985	250011SA	250011SB	\$2094	24	31	85 P+
6' 6"	47" x 63"	51" x 67"	251012	685	250012SC	2139	250012SA	250012SB	2244	25	35	85 P+
7' 6"	54" x 72"	58" x 76"	251013	822	250013SC	2562	250013SA	250013SB	2671	26	37	85 P+
100"	60" x 80"	64" x 84"	251014	915	250014SC	2619	250063	250108	2726	28	39	85 P+
10'	72" x 96"	76" x 100"	251005	1127	250005SC	3402	250064	250109	3507	30	40	85 P+
11'	78" x 104"	82" x 108"	251016	1272	250016SC	3664	--	--	--	34	43	85 P+
150"	90" x 120"	94" x 124"	251007	1357	250007SC	3846	--	--	--	36	49	85 P+
15'	108" x 144"	112" x 148"	251009	1642	--	--	--	--	--	43		85
200"	120" x 160"	124" x 164"	251019	1990	--	--	--	--	--	48		85
240**	144" x 194"	156" x 206"	251020	5414	--	--	--	--	--	100	107	85 P+
25*	180" x 240"	192" x 252"	251021	7693	--	--	--	--	--	172		85
<b>2.35:1 CinemaScope Format</b>												
115"	45" x 105 3/4"	49" x 109 3/4"	--	--	251035SC	\$2974	251047	251051	\$3081	22	30	85 P+
132"	52" x 122"	56" x 126"	--	--	251036SC	3839	251048	251052	3949	26	34	85 P+
148"	58" x 136 1/4"	62" x 140 1/4"	--	--	251037SC	4673	251049	251053	4781	28	38	85 P+
153"	60" x 141"	64" x 145"	--	--	251133SC	5203	251137	251138	5309	33	40	85 P+
166"	65" x 152 3/4"	69" x 156 3/4"	--	--	251038SC	5746	251050	251054	5855	47	41	85 P+

## Accessories for Truss Cineperm

	Part No.	PRICE
Fly Bracket (single)	385223	\$54
Fly Bracket (pair)	385224	101

For Pricing on Screen material, see page 47.

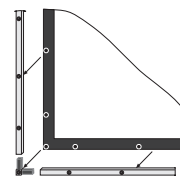

Standard Construction

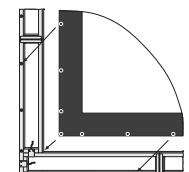

Truss Style Construction  
(very large sizes only)

The Clarion's aluminum frame forms an attractive 2" border for a clean, theatre-like appearance. The standard frame color is black. Fabric attaches without snaps for quick assembly and a perfectly smooth viewing surface. Permanent wall mounting brackets included.

- **Options:** Custom sizes available by quotation. Vel-Tex, a black, velvety textile covering is a recommended option that cuts reflection and conceals all trace of joints in the frame. **To include Vel-Tex on a Clarion screen where it is not standard, add the letter "V" after the part number when ordering (for example, Part number 252019V).**

CineFlex White XT700V front/rear projection surface is also available at the same price as CineFlex CH1200V. See page 5 for viewing surface details. When ordering these surfaces, use the CineFlex CH1200V part number followed by the appropriate suffix: CD for CineFlex White XT700V.

For ClearSound screen surfaces in sizes not listed, call Draper for quotation.

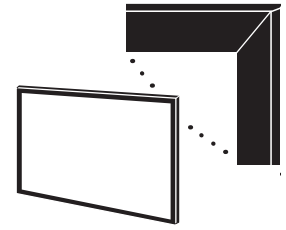

Nom. Diag.	Image Area	Overall Size	OptiFlex Surfaces				Ship Wt./lbs.	Dim Wt./lbs.	Freight Class
			Matt White XT1000V	Pure White XT1300V	PRICE	Grey XH600V			
<b>16:10 Format</b>									
67"	35 1/4" x 56 1/2"	39 1/4" x 60 1/2"	252190	252190FN	\$872	252198	\$919	21	85 P+
76"	40" x 64"	44" x 68"	252191	252191FN	919	252199	970	21	38 85 P+
85"	45" x 72"	49" x 76"	252192	252192FN	1024	252200	1080	24	40 85 P+
94"	50" x 80"	54" x 84"	252193	252193FN	1165	252201	1232	26	44 85 P+
109"	57 1/2" x 92"	61 1/2" x 96"	252194	252194FN	1454	252202	1535	31	50 85 P+
113"	59 1/8" x 95 3/4"	63 7/8" x 99 3/4"	252295	252295FN	1585	252298	1672	47	49 85 P
123"	65" x 104"	69" x 108"	252195	252195FN	1720	252203	1815	47	85
137"	72 1/2" x 116"	76 1/2" x 120"	252196	252196FN	1985	252204	2095	41	85
165"	87 1/2" x 140"	91 1/2" x 144"	252197	252197FN	2252	252205	2377	52	85
<b>16:9 HDTV Format</b>									
65"	31 3/4" x 56 1/2"	35 3/4" x 60 1/2"	252139	252139FN	\$872	252145	\$919	21	85 P+
73"	36" x 64"	40" x 68"	252140	252140FN	919	252146	970	21	85 P+
82"	40 1/2" x 72"	44 1/2" x 76"	252141	252141FN	1024	252147	1080	23	40 85 P+
92"	45" x 80"	49" x 84"	252016	252016FN	1165	252104	1232	25	45 85 P+
100"	49" x 87"	53" x 91"	252247	252247FN	1275	252250	1347	47	48 85 P+
106"	52" x 92"	56" x 96"	252017	252017FN	1454	252105	1535	30	49 85 P+
110"	54" x 96"	58" x 100"	252256	252256FN	1530	252259	1614	30	52 85 P+
119"	58" x 104"	62" x 108"	252133	252133FN	1720	252138	1815	32	85
133"	65" x 116"	69" x 120"	252018	252018FN	1985	252106	2095	39	85
161"	79" x 140"	83" x 144"	252019	252019FN	2252	252107	2377	50	85
<b>4:3 NTSC Video Format</b>									
6"	43" x 57"	47" x 61"	252008	252008FN	\$798	252096	\$844	21	85 P+
6' 6"	47" x 63"	51" x 67"	252009	252009FN	892	252097	940	23	36 85 P+
7"	50" x 67"	54" x 71"	252010	252010FN	942	252098	994	24	38 85 P+
7' 6"	54" x 72"	58" x 76"	252011	252011FN	1117	252099	1179	25	40 85 P+
100"	60" x 80"	64" x 84"	252012	252012FN	1165	252100	1232	29	45 85 P+
10'	72" x 96"	76" x 100"	252013	252013FN	1454	252101	1535	34	51 85 P+
150"	90" x 120"	94" x 124"	252014	252014FN	1985	252102	2095	47	85
15'	108" x 144"	112" x 148"	252015	252015FN	2559	252156	2699	59	85
<b>2.35:1 CinemaScope Format</b>									
115"	45" x 105 3/4"	49" x 109 3/4"	252244	252244FN	\$1677	252244FB	\$1762	32	85
132"	52" x 122"	56" x 126"	252245	252245FN	2019	252245FB	2120	38	85
148"	58" x 136 1/4"	62" x 140 1/4"	252246	252246FN	2310	252246FB	2427	42	85
<b>16:9 HDTV Format with Vel-Tex</b>									
82"	40 1/2" x 72"	44 1/2" x 76"	252283	252283FN	\$1249	252285	\$1305	23	40 85 P
92"	45" x 80"	49" x 84"	252087	252087FN	1390	252151	1457	27	44 85 P+
100"	49" x 87"	53" x 91"	252252	252252FN	1500	252253	1572	28	48 85 P+
106"	52" x 92"	56" x 96"	252088	252088FN	1679	252152	1760	31	50 85 P+
110"	54" x 96"	58" x 100"	252261	252261FN	1755	252262	1839	31	52 85 P+
119"	58" x 104"	62" x 108"	252137	252137FN	1945	252153	2040	34	85
133"	65" x 116"	69" x 120"	252277	252277FN	2210	252286	2320	38	85
161"	79" x 140"	83" x 144"	252290	252290FN	2477	252291	2602	50	85
<b>4:3 NTSC Video Format with Vel-Tex</b>									
7"	50" x 67"	54" x 71"	252084	252084FN	\$1167	252084FB	\$1219	30	39 85 P+
100"	60" x 80"	64" x 84"	252085	252085FN	1390	252085FB	1457	40	45 85 P+
10'	72" x 96"	76" x 100"	252086	252086FN	1679	252086FB	1760	58	85
<b>2.35:1 CinemaScope Format with Vel-Tex</b>									
115"	45" x 105 3/4"	49" x 109 3/4"	252170	252170FN	\$1762	252178	\$1987	47	85
132"	52" x 122"	56" x 126"	252171	252171FN	2244	252179	2345	54	85
148"	58" x 136 1/4"	62" x 140 1/4"	252172	252172FN	2536	252180	2652	56	85
153"	60" x 141"	64" x 145"	252271	252271FN	2757	252272	2897	55	85
166"	65" x 152 3/4"	69" x 156 3/4"	252173	252173FN	2927	252181	3079	48	85

For Pricing on Screen material, see page 47.

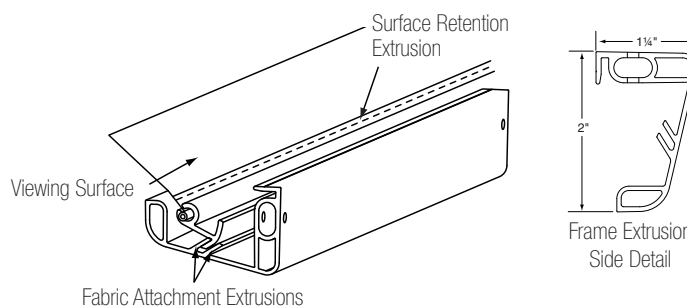

CONTINUED

CHART

FIXED SCREENS

Nom. Diag.	Image Area	Overall Size	CineFlex Surface		ClearSound Surfaces					Ship Wt./lbs.	Dim Wt./lbs.	Freight Class
			CineFlex CH1200V	PRICE	ClearSound NanoPerf XT1000V	PRICE	ClearSound White Weave XT900E	ClearSound Grey Weave XH600E	PRICE			
<b>16:10 Format</b>												
67"	35 1/4" x 56 1/2"	39 1/4" x 60 1/2"	252190CB	\$1029	252190SC	\$2117	252190SA	252190SB	\$2212	21		85 P+
76"	40" x 64"	44" x 68"	252191CB	1084	252191SC	2159	252191SA	252191SB	2254	21	38	85 P+
85"	45" x 72"	49" x 76"	252192CB	1209	252192SC	2334	252192SA	252192SB	2429	24	40	85 P+
94"	50" x 80"	54" x 84"	252193CB	1375	252193SC	2522	252193SA	252193SB	2619	26	44	85 P+
109"	57 1/2" x 92"	61 1/2" x 96"	252194CB	1715	252194SC	3687	252194SA	252194SB	3782	31	50	85 P+
113"	59 7/8" x 95 3/4"	63 7/8" x 99 3/4"	252295CB	1870	252295SC	4066	252295SA	252295SB	4162	47	49	85 P
123"	65" x 104"	69" x 108"	252195CB	2030	252195SC	4443	252195SA	252195SB	4539	47		85
137"	72 1/2" x 116"	76 1/2" x 120"	--	--	252196SC	4584	252196SA	252196SB	4681	51		85
165"	87 1/2" x 140"	91 1/2" x 144"	--	--	252197SC	6036	252197SA	252197SB	6133	52		85
<b>16:9 HDTV Format</b>												
65"	31 3/4" x 56 1/2"	35 3/4" x 60 1/2"	252165	\$1029	252139SC	\$1957	252139SA	252139SB	\$2054	21		85 P+
73"	36" x 64"	40" x 68"	252166	1084	252140SC	2117	252140SA	252140SB	2212	21		85 P+
82"	40 1/2" x 72"	44 1/2" x 76"	252167	1209	252141SC	2284	252141SA	252141SB	2380	23	40	85 P+
92"	45" x 80"	49" x 84"	252168	1375	252016SC	2526	252075	252123	2622	25	45	85 P+
100"	49" x 87"	53" x 91"	252247CB	1505	252247SC	2767	252249	252251	2864	27	48	85 P+
106"	52" x 92"	56" x 96"	252017CB	1715	252017SC	3689	252076	252124	3784	30	49	85 P+
110"	54" x 96"	58" x 100"	252256CB	1805	252256SC	3886	252258	252260	3982	30	52	85 P+
119"	58" x 104"	62" x 108"	252133CB	2030	252133SC	4448	252136	252132	4543	32		85
133"	65" x 116"	69" x 120"	--	--	252018SC	4494	252077	252125	4683	39		85
161"	79" x 140"	83" x 144"	--	--	252019SC	6040	252078	252126	6073	50		85
<b>4:3 NTSC Video Format</b>												
6"	43" x 57"	47" x 61"	252160	\$942	252008SC	\$2405	252008SA	252008SB	\$2504	21		85 P+
6' 6"	47" x 63"	51" x 67"	252161	1052	252009SC	2307	252009SA	252009SB	2404	23	36	85 P+
7"	50" x 67"	54" x 71"	252162	1112	252010SC	2562	252010SA	252010SB	2659	24	38	85 P+
7' 6"	54" x 72"	58" x 76"	252163	1319	252011SC	2849	252011SA	252011SB	2942	25	40	85 P+
100"	60" x 80"	64" x 84"	252164	1375	252012SC	3167	252073	252121	3266	29	45	85 P+
10'	72" x 96"	76" x 100"	252013CB	1715	252013SC	4159	252074	252122	4254	34	51	85 P+
150"	90" x 120"	94" x 124"	--	--	252014SC	4648	252014SA	252014SB	4744	47		85
15'	108" x 144"	112" x 148"	--	--	--	--	252015SA	252015SB	6161	59		85
<b>2.35:1 CinemaScope Format</b>												
115"	45" x 105 3/4"	49" x 109 3/4"	252244CB	\$1979	252244SC	\$3147	252265	252266	\$3244	32		85
132"	52" x 122"	56" x 126"	--	--	252245SC	3991	252267	252268	4086	38		85
148"	58" x 136 1/4"	62" x 140 1/4"	--	--	252246SC	4783	252269	252270	4878	42		85
<b>16:9 HDTV Format with Vel-Tex</b>												
82"	40 1/2" x 72"	44 1/2" x 76"	252283CB	\$1474	252283SC	\$2509	252283SA	252283SB	\$2606	23	40	85 P
92"	45" x 80"	49" x 84"	252087CB	1600	252087SC	2751	252239	252240	2847	27	44	85 P+
100"	49" x 87"	53" x 91"	252252CB	1730	252252SC	2992	252254	252255	3089	28	48	85 P+
106"	52" x 92"	56" x 96"	252088CB	1940	252088SC	3914	252241	252242	4009	31	50	85 P+
110"	54" x 96"	58" x 100"	252261CB	2030	252261SC	4111	252263	252264	4208	31	52	85 P+
119"	58" x 104"	62" x 108"	252137CB	2255	252137SC	4673	252243	252238	4768	34		85
133"	65" x 116"	69" x 120"	--	--	252277SC	4719	252288	252289	4908	38		85
161"	79" x 140"	83" x 144"	--	--	252290SC	6265	252293	252294	6298	50		85
<b>4:3 NTSC Video Format with Vel-Tex</b>												
7"	50" x 67"	54" x 71"	252084CB	\$1337	252084SC	\$2787	252084SA	252084SB	\$2884	30	39	85 P+
100"	60" x 80"	64" x 84"	252085CB	1640	252085SC	3392	252085SA	252085SB	3491	40	45	85 P+
10'	72" x 96"	76" x 100"	252086CB	1940	252086SC	4384	252086SA	252086SB	4479	58		85
<b>2.35:1 CinemaScope Format with Vel-Tex</b>												
115"	45" x 105 3/4"	49" x 109 3/4"	252170CB	\$2204	252170SC	\$3372	252182	252186	\$3469	47		85
132"	52" x 122"	56" x 126"	--	--	252171SC	4216	252183	252187	4311	54		85
148"	58" x 136 1/4"	62" x 140 1/4"	--	--	252172SC	5008	252184	252188	5103	56		85
153"	60" x 141"	64" x 145"	--	--	252271SC	5404	252275	252276	5564	57		85
166"	65" x 152 3/4"	69" x 156 3/4"	--	--	252173SC	6003	252185	252189	6511	58		85

**TECVISION** \*\* To order a screen with a TecVision® surface, the suffix codes should be added to the end of the Matt White XT1000V part number. (Ex. 252190TA for a 67" screen with the TecVision® CS1000X ALR surface.)  
 See page 6 for full descriptions and formula codes of all available TecVision® surfaces.

Nom. Diag.	Image Area	Overall Size	TecVision® Surfaces				Ship Wt./lbs.	Dim Wt./lbs.	Freight Class
			TecVision®	PRICE	TecVision® NanoPerf	PRICE			
<b>16:10 Format</b>									
67"	35 1/4" x 56 1/2"	39 1/4" x 60 1/2"	252190**	\$1334	252190**	\$2579	21		85 P+
76"	40" x 64"	44" x 68"	252191**	1510	252191**	2751	21	38	85 P+
85"	45" x 72"	49" x 76"	252192**	1774	252192**	3084	24	40	85 P+
94"	50" x 80"	54" x 84"	252193**	2092	252193**	3449	26	44	85 P+
109"	57 1/2" x 92"	61 1/2" x 96"	252194**	2679	252194**	4913	31	50	85 P+
113"	59 7/8" x 95 3/4"	63 7/8" x 99 3/4"	252295**	2912	252295**	5393	47	49	85 P
123"	65" x 104"	69" x 108"	252195**	3287	252195**	6010	47		85
137"	72 1/2" x 116"	76 1/2" x 120"	252196**	3932	252196**	6531	41		85
165"	87 1/2" x 140"	91 1/2" x 144"	252197**	5088	252197**	8872	52		85
<b>16:9 HDTV Format</b>									
65"	31 3/4" x 56 1/2"	35 3/4" x 60 1/2"	252139**	\$1289	252139**	\$2374	21		85 P+
73"	36" x 64"	40" x 68"	252140**	1452	252140**	2651	21		85 P+
82"	40 1/2" x 72"	44 1/2" x 76"	252141**	1700	252141**	2961	23	40	85 P+
92"	45" x 80"	49" x 84"	252016**	1999	252016**	3359	25	45	85 P+
100"	49" x 87"	53" x 91"	252247**	2262	252247**	3754	27	48	85 P+
106"	52" x 92"	56" x 96"	252017**	2561	252017**	4796	30	49	85 P+
110"	54" x 96"	58" x 100"	252256**	2731	252256**	5086	30	52	85 P+
119"	58" x 104"	62" x 108"	252133**	3117	252133**	5845	32		85
133"	65" x 116"	69" x 120"	252018**	3732	252018**	6241	39		85
161"	79" x 140"	83" x 144"	252019**	4813	252019**	8600	50		85
<b>4:3 NTSC Video Format</b>									
6'	43" x 57"	47" x 61"	252008**	\$1365	252008**	\$2972	21		85 P+
6' 6"	47" x 63"	51" x 67"	252009**	1579	252009**	2994	23	36	85 P+
7'	50" x 67"	54" x 71"	252010**	1717	252010**	3337	24	38	85 P+
7' 6"	54" x 72"	58" x 76"	252011**	2017	252011**	3749	25	40	85 P+
100"	60" x 80"	64" x 84"	252012**	2277	252012**	4279	29	45	85 P+
10'	72" x 96"	76" x 100"	252013**	3054	252013**	5759	34	51	85 P+
150"	90" x 120"	94" x 124"	252014**	4486	252014**	7148	47		85
15'	108" x 144"	112" x 148"	252015**	6160	--	--	59		85
<b>2.35:1 CinemaScope Format</b>									
115"	45" x 105 3/4"	49" x 109 3/4"	252244**	\$2779	252244**	\$4249	32		85
132"	52" x 122"	56" x 126"	252245**	3487	252245**	5459	38		85
148"	58" x 136 1/4"	62" x 140 1/4"	252246**	4137	252246**	6610	42		85

FIXED SCREENS

**Accessories for Clarion**

	Part No.	PRICE
<b>Corner Reinforcement Kit</b> —The Corner Reinforcement Kit is required for any Clarion that: will be suspended or "flown," is used with Acrobat, or has a viewing area greater than 120" in either height or width.	252154	\$98
<b>Vel-Tex®</b> —A velvety black textile that cuts reflections to virtually zero and conceals all trace of joints in the frame. To include Vel-Tex on a Clarion screen where it is not standard, add the letter "V" after the part number when ordering (for example, Part number 252019V).		225

**Freight Class Key**  
**Number** LTL freight class  
**P** . . . . . Parcel Service  
**+** . . . . . \$15.00 surcharge (over 48" long)  
**Example:** a freight code of 125 P+ indicates an item that may ship as freight class 125 or via parcel service with \$15.00 surcharge.

# Onyx

The Onyx has a 4" wide, beveled trim frame and a proprietary adjustable surface tensioning system that keeps the viewing surface perfectly flat, with no puckering. No snaps—assembles easily in minutes. The miter cut frame is wider to handle overscan, and provides up to 1 1/2" of horizontal or vertical viewing surface tension adjustment. Black painted aluminum frame is standard.

**Options:** Custom sizes, by quotation. Vel-Tex, a black, velvety textile covering, is a recommended option that cuts reflection and conceals all trace of joints in the frame. **To include Vel-Tex on an Onyx screen where it is not standard, add the letter "V" after the part number when ordering (for example, Part number 253215V).**

CineFlex White XT700V front/rear projection surface is also available at the same price as CineFlex CH1200V. See page 5 for viewing surface details. When ordering these surfaces, use the CineFlex CH1200V part number followed by the appropriate suffix: **CD** for CineFlex White XT700V.



**For ClearSound screen surfaces in sizes not listed below, call Draper for quotation.**

FIXED SCREENS

Nom. Diag.	Image Area	Overall Size	OptiFlex Surfaces				Ship Wt./lbs.	Dim Wt./lbs.	Freight Class
			Matt White XT1000V	Pure White XT1300V	PRICE	Grey XH600V			
<b>16:10 Format</b>									
67"	35 1/4" x 56 1/2"	43 1/4" x 64 1/2"	253817	253817FN	\$935	253816	\$987	35	85 P+
76"	40" x 64"	48" x 72"	253821	253821FN	992	253820	1044	37	85 P+
85"	45" x 72"	53" x 80"	253825	253825FN	1099	253824	1159	39	85 P+
94"	50" x 80"	58" x 88"	253831	253831FN	1254	253830	1322	42	85 P+
109"	57 1/2" x 92"	65 1/2" x 100"	253837	253837FN	1560	253836	1647	50	85 P+
113"	60" x 96"	68" x 104"	253892	253892FN	1620	253893	1712	55	85
123"	65" x 104"	73" x 112"	253843	253843FN	1845	253842	1947	57	85
137"	72 1/2" x 116"	80 1/2" x 124"	253849	253849FN	2132	253848	2249	63	85
165"	87 1/2" x 140"	95 1/2" x 148"	253855	253855FN	2420	253854	2554	66	85
<b>16:9 HDTV Format</b>									
65"	31 3/4" x 56 1/2"	39 3/4" x 64 1/2"	253606	253606FN	\$935	253612	\$987	35	85 P+
73"	36" x 64"	44" x 72"	253607	253607FN	992	253613	1044	39	85 P+
82"	40 1/2" x 72"	48 1/2" x 80"	253608	253608FN	1099	253614	1159	41	85 P+
92"	45" x 80"	53" x 88"	253216	253216FN	1254	253304	1322	42	85 P+
100"	49" x 87"	57" x 95"	253699	253699FN	1485	253497	1567	45	85 P+
106"	52" x 92"	60" x 100"	253217	253217FN	1560	253305	1647	49	85 P+
110"	54" x 96"	62" x 104"	253379	253379FN	1620	253461	1712	54	85 P+
119"	58" x 104"	66" x 112"	253338	253338FN	1845	253340	1947	56	85
133"	65" x 116"	73" x 124"	253218	253218FN	2132	253306	2249	63	85
161"	79" x 140"	87" x 148"	253219	253219FN	2420	253307	2554	83	85
193"	95" x 169"	103" x 177"	253773	253773FN	2842	253772	2997	110	85
220"	108" x 192"	116" x 200"	253784	253784FN	3066	253783	3236	112	85
<b>4:3 NTSC Video Format</b>									
6"	43" x 57"	51" x 65"	253208	253208FN	\$857	253296	\$905	35	85 P+
6' 6"	47" x 63"	55" x 71"	253209	253209FN	957	253297	1007	38	85 P+
7"	50" x 67"	58" x 75"	253210	253210FN	1012	253298	1067	39	85 P+
7' 6"	54" x 72"	62" x 80"	253211	253211FN	1197	253299	1264	41	85 P+
100"	60" x 80"	68" x 88"	253212	253212FN	1254	253300	1322	45	85 P+
10'	72" x 96"	80" x 104"	253213	253213FN	1560	253301	1647	51	85 P+
150"	90" x 120"	98" x 128"	253214	253214FN	2132	253302	2249	62	85
15'	108" x 144"	116" x 152"	253215	253215FN	2751	253705	2904	74	85
<b>16:10 Format with Vel-Tex</b>									
67"	35 1/4" x 56 1/2"	43 1/4" x 64 1/2"	253859	253859FN	\$1160	253858	\$1212	35	85 P+
76"	40" x 64"	48" x 72"	253862	253862FN	1217	253861	1269	37	85 P+
85"	45" x 72"	53" x 80"	253865	253865FN	1324	253864	1384	39	85 P+
94"	50" x 80"	58" x 88"	253870	253870FN	1479	253869	1547	42	85 P+
109"	57 1/2" x 92"	65 1/2" x 100"	253875	253875FN	1785	253874	1872	50	85 P+
113"	60" x 96"	68" x 104"	253898	253898FN	1845	253930	1937	50	85 P
123"	65" x 104"	73" x 112"	253880	253880FN	2070	253879	2172	60	85
137"	72 1/2" x 116"	80 1/2" x 124"	253883	253883FN	2357	253882	2474	63	85
<b>16:9 HDTV Format with Vel-Tex</b>									
65"	31 3/4" x 56 1/2"	39 3/4" x 64 1/2"	253620	253620FN	\$1160	253626	\$1212	35	85 P+
73"	36" x 64"	44" x 72"	253621	253621FN	1217	253627	1269	39	85 P+
82"	40 1/2" x 72"	48 1/2" x 80"	253622	253622FN	1324	253628	1384	41	85 P+
92"	45" x 80"	53" x 88"	253287	253287FN	1479	253342	1547	42	85 P+
100"	49" x 87"	57" x 95"	253476	253476FN	1710	253375	1792	48	85 P+
106"	52" x 92"	60" x 100"	253288	253288FN	1785	253343	1872	49	85 P+
110"	54" x 96"	62" x 104"	253383	253383FN	1845	253514	1937	54	85
119"	58" x 104"	66" x 112"	253374	253374FN	2070	253344	2172	56	85
133"	65" x 116"	73" x 124"	253399	253399FN	2357	253384	2474	63	85
161"	79" x 140"	87" x 148"	253429	253429FN	2646	253433	2779	83	85
193"	95" x 169"	103" x 177"	253779	253779FN	3067	253778	3222	110	85
220"	108" x 192"	116" x 200"	253790	253790FN	3291	253789	3461	112	85
<b>4:3 NTSC Video Format with Vel-Tex</b>									
7"	50" x 67"	58" x 75"	253284	253284FN	\$1237	253404	\$1292	39	85 P+
100"	60" x 80"	68" x 88"	253285	253285FN	1479	253341	1547	45	85 P+
10'	72" x 96"	80" x 104"	253286	253286FN	1785	253463	1872	51	85 P+
<b>2.35:1 CinemaScope Format</b>									
115"	45" x 105 3/4"	53" x 113 3/4"	253748	253748FN	\$2020	253747	\$2130	61	85
132"	52" x 122"	60" x 130"	253753	253753FN	2334	253752	2462	64	85
148"	58" x 136 1/4"	66" x 144 1/4"	253758	253758FN	2887	253757	3044	68	85
153"	60" x 141"	68" x 149"	253886	253886FN	3134	253887	3304	68	85
166"	65" x 152 3/4"	73" x 160 3/4"	253763	253763FN	3292	253762	3472	75	85
204"	80" x 188"	88" x 196"	253768	253768FN	4363	253767	4601	78	85

For Pricing on Screen material, see page 47.

Nom. Diag.	Image Area	Overall Size	CineFlex Surface		ClearSound Surfaces			Ship Wt./lbs.	Dim Wt./lbs.	Freight Class	
			CineFlex CH1200V	PRICE	ClearSound NanoPerf XT1000V	PRICE	ClearSound White Weave XT900E				ClearSound Grey Weave XH600E
<b>16:10 Format</b>											
67"	35 1/4" x 56 1/2"	43 1/4" x 64 1/2"	253819	\$1104	253817SC	\$2187	253817SA	253817SB	\$2287	35	85 P+
76"	40" x 64"	48" x 72"	253823	1170	253821SC	2365	253821SA	253821SB	2465	37	85 P+
85"	45" x 72"	53" x 80"	253827	1297	253825SC	2559	253825SA	253825SB	2659	39	85 P+
94"	50" x 80"	58" x 88"	253833	1479	253831SC	2766	253829	253828	2867	42	85 P+
109"	57 1/2" x 92"	65 1/2" x 100"	253839	1840	253837SC	4046	253835	253834	4146	50	85 P+
113"	60" x 96"	68" x 104"	253895	1912	253892SC	4543	253897	253896	4643	55	85
123"	65" x 104"	73" x 112"	253845	2177	253843SC	4876	253841	253840	4976	57	85
137"	72 1/2" x 116"	80 1/2" x 124"	253851	2516	253849SC	5028	253847	253846	5128	63	85
165"	87 1/2" x 140"	95 1/2" x 148"	253857	2856	253855SC	6615	253853	253852	6713	66	85
<b>16:9 HDTV Format</b>											
65"	31 3/4" x 56 1/2"	39 3/4" x 64 1/2"	253615	\$1104	253606SC	\$2134	253606SA	253606SB	\$2235	35	85 P+
73"	36" x 64"	44" x 72"	253616	1170	253607SC	2307	253607SA	253607SB	2407	39	85 P+
82"	40 1/2" x 72"	48 1/2" x 80"	253617	1297	253608SC	2494	253608SA	253608SB	2594	41	85 P+
92"	45" x 80"	53" x 88"	253328	1479	253216SC	3042	253275	253359	2867	42	85 P+
100"	49" x 87"	57" x 95"	253794	1752	253699SC	3589	253793	253795	3364	45	85 P+
106"	52" x 92"	60" x 100"	253329	1840	253217SC	4046	253276	253360	4146	49	85 P+
110"	54" x 96"	62" x 104"	253809	1912	253379SC	4543	253808	253810	4643	54	85 P+
119"	58" x 104"	66" x 112"	253330	2177	253338SC	4876	253369	253368	4976	56	85
133"	65" x 116"	73" x 124"	253331	2516	253218SC	5529	253277	253361	5128	63	85
161"	79" x 140"	87" x 148"	253332	2856	253219SC	6615	253278	253362	6713	83	85
193"	95" x 169"	103" x 177"	253775	3354	253773SC	7001	253771	253770	7101	110	85
220"	108" x 192"	116" x 200"	253786	3617	--	--	253782	253781	7663	112	85
<b>4:3 NTSC Video Format</b>											
6'	43" x 57"	51" x 65"	253320	\$1012	253208SC	\$2279	253208SA	253208SB	\$2379	35	85 P+
6' 6"	47" x 63"	55" x 71"	253321	1129	253209SC	2534	253209SA	253209SB	2634	38	85 P+
7'	50" x 67"	58" x 75"	253322	1194	253210SC	2814	253210SA	253210SB	2914	39	85 P+
7' 6"	54" x 72"	62" x 80"	253323	1412	253211SC	3126	253211SA	253211SB	3224	41	85 P+
100"	60" x 80"	68" x 88"	253324	1479	253212SC	3819	253273	253357	3571	45	85 P+
10'	72" x 96"	80" x 104"	253325	1840	253213SC	4561	253274	253358	4661	51	85 P+
150"	90" x 120"	98" x 128"	253326	2516	253214SC	4911	253812	253813	5011	62	85
15'	108" x 144"	116" x 152"	253327	3246	--	--	253814	253815	5499	74	85
<b>16:10 Format with Vel-Tex</b>											
67"	35 1/4" x 56 1/2"	43 1/4" x 64 1/2"	253859CB	\$1329	253859SC	\$2412	253859SA	253859SB	\$2512	35	85 P+
76"	40" x 64"	48" x 72"	253862CB	1395	253862SC	2591	253862SA	253862SB	2691	37	85 P+
85"	45" x 72"	53" x 80"	253865CB	1522	253865SC	2784	253865SA	253865SB	2884	39	85 P+
94"	50" x 80"	58" x 88"	253870CB	1704	253870SC	2991	253868	253867	3092	42	85 P+
109"	57 1/2" x 92"	65 1/2" x 100"	253875CB	2065	253875SC	4271	253873	253872	4371	50	85 P+
113"	60" x 96"	68" x 104"	253898CB	2137	253898SC	4768	253933	253932	4868	50	85 P
123"	65" x 104"	73" x 112"	253880CB	2402	253880SC	5101	253878	253877	5201	60	85
137"	72 1/2" x 116"	80 1/2" x 124"	253883CB	2741	253883SC	5253	--	--	--	63	85
<b>16:9 HDTV Format</b>											
65"	31 3/4" x 56 1/2"	39 3/4" x 64 1/2"	253620CB	\$1329	253620SC	\$2359	253620SA	253620SB	\$2460	35	85 P+
73"	36" x 64"	44" x 72"	253621CB	1395	253621SC	2532	253621SA	253621SB	2632	39	85 P+
82"	40 1/2" x 72"	48 1/2" x 80"	253622CB	1522	253622SC	2719	253622SA	253622SB	2819	41	85 P+
92"	45" x 80"	53" x 88"	253287CB	1704	253287SC	3267	253406	253381	3092	42	85 P+
100"	49" x 87"	57" x 95"	253476CB	1977	253476SC	3814	253566	253796	3589	48	85 P+
106"	52" x 92"	60" x 100"	253288CB	2065	253288SC	4271	253412	253510	4371	49	85 P+
110"	54" x 96"	62" x 104"	253383CB	2137	253383SC	4768	253582	253675	4868	54	85
119"	58" x 104"	66" x 112"	253374CB	2402	253374SC	5101	253483	253431	5201	56	85
133"	65" x 116"	73" x 124"	253399CB	2741	253399SC	5754	253425	253597	5353	63	85
161"	79" x 140"	87" x 148"	253429CB	3081	253429SC	6840	253722	253636	6938	83	85
193"	95" x 169"	103" x 177"	253790CB	3579	253790SC	7226	253777	253776	7326	110	85
220"	108" x 192"	116" x 200"	253790CB	3842	--	--	253788	253787	7888	112	85
<b>4:3 NTSC Video Format</b>											
7'	50" x 67"	58" x 75"	253284CB	\$1419	253284SC	\$3039	253284SA	253284SB	\$3139	39	85 P+
100"	60" x 80"	68" x 88"	253285CB	1704	253285SC	4044	253285SA	253285SB	3796	45	85 P+
10'	72" x 96"	80" x 104"	253286CB	2065	253286SC	4786	253286SA	253286SB	4886	51	85 P+
<b>2.35:1 CinemaScope Format</b>											
115"	45" x 105 3/4"	53" x 113 3/4"	253748CB	\$2344	253748SC	\$3861	253745	253746	\$3962	61	85
132"	52" x 122"	60" x 130"	253753CB	2714	253753SC	4789	253750	253751	4893	64	85
148"	58" x 136 1/4"	66" x 144 1/4"	253758CB	3366	253758SC	5698	253755	253756	5799	68	85
153"	60" x 141"	68" x 149"	253886CB	3657	253886SC	6143	253890	253891	6246	68	85
166"	65" x 152 3/4"	73" x 160 3/4"	253763CB	3844	253763SC	6780	253760	253761	6880	75	85
204"	80" x 188"	88" x 196"	253768CB	5108	253768SC	9532	253765	253766	9635	78	85

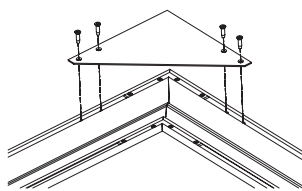

Corner Reinforcement Kit

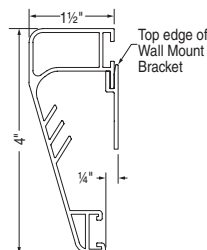

Frame Extrusion Side Detail

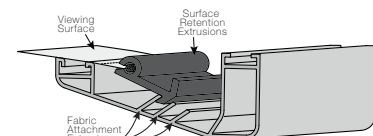
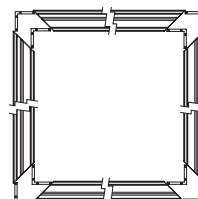

**TECVISION** \*\* To order a screen with a TecVision® surface, the suffix codes should be added to the end of the Matt White XT1000V part number.  
 (Ex. 253817TA for a 67" screen with the TecVision® CS1000X ALR surface.)  
 See page 6 for full descriptions and formula codes of all available TecVision® surfaces.

FIXED SCREENS

Nom. Diag.	Image Area	Overall Size	TecVision® Viewing Surfaces				Ship Wt./lbs.	Dim Wt./lbs.	Freight Class
			TecVision®	PRICE	TecVision® NanoPerf	PRICE			
<b>16:10 Format</b>									
67"	35 1/4" x 56 1/2"	43 1/4" x 64 1/2"	253817**	\$1397	253817**	\$2649	35		85 P+
76"	40" x 64"	48" x 72"	253821**	1584	253821**	2957	37	38	85 P+
85"	45" x 72"	53" x 80"	253825**	1849	253825**	3309	39	42	85 P+
94"	50" x 80"	58" x 88"	253831**	2180	253831**	3692	42	46	85 P+
109"	57 1/2" x 92"	65 1/2" x 100"	253837**	2786	253837**	5271	50	52	85 P+
113"	60" x 96"	68" x 104"	253892**	2954	253892**	5876	55		85
123"	65" x 104"	73" x 112"	253843**	3412	253843**	6443	57		85
137"	72 1/2" x 116"	80 1/2" x 124"	253849**	4079	253849**	6975	63		85
165"	87 1/2" x 140"	95 1/2" x 148"	253855**	5256	253855**	9450	66		85
<b>16:9 HDTV Format</b>									
65"	31 3/4" x 56 1/2"	39 3/4" x 64 1/2"	253606**	\$1352	253606**	\$2551	35		85 P+
73"	36" x 64"	44" x 72"	253607**	1525	253607**	2841	39		85 P+
82"	40 1/2" x 72"	48 1/2" x 80"	253608**	1775	253608**	3171	41		85 P+
92"	45" x 80"	53" x 88"	253216**	2087	253216**	3876	42	46	85 P+
100"	49" x 87"	57" x 95"	253699**	2472	253699**	4576	45	48	85 P+
106"	52" x 92"	60" x 100"	253217**	2667	253217**	5153	49	51	85 P+
110"	54" x 96"	62" x 104"	253379**	2821	253379**	5743	54		85 P+
119"	58" x 104"	66" x 112"	253338**	3242	253338**	6273	56		85
133"	65" x 116"	73" x 124"	253218**	3879	253218**	7276	63		85
161"	79" x 140"	87" x 148"	253219**	4981	253219**	9175	83		85
193"	95" x 169"	103" x 177"	253773**	6560	--	--	110		85
220"	108" x 192"	116" x 200"	253784**	7867	--	--	112		85
<b>4:3 NTSC Video Format</b>									
6"	43" x 57"	51" x 65"	253208**	\$1424	253208**	\$2846	35		85 P+
6' 6"	47" x 63"	55" x 71"	253209**	1644	253209**	3221	38		85 P+
7"	50" x 67"	58" x 75"	253210**	1787	253210**	3589	39		85 P+
7' 6"	54" x 72"	62" x 80"	253211**	2097	253211**	4026	41		85 P+
100"	60" x 80"	68" x 88"	253212**	2365	253212**	4931	45		85 P+
10'	72" x 96"	80" x 104"	253213**	3161	253213**	6161	51		85 P+
150"	90" x 120"	98" x 128"	253214**	4633	253214**	7411	62		85
15'	108" x 144"	116" x 152"	253215**	6351	253215**	--	74		85

## Accessories for Onyx

	Part No.	PRICE
<b>Corner Reinforcement Kit</b> —The Corner Reinforcement Kit is required for any Onyx that: will be suspended or "flown," or used with Acrobat.	253696	\$117
<b>Vel-Tex®</b> —A velvety black textile that cuts reflections to virtually zero and conceals all trace of joints in the frame. To include Vel-Tex on an Onyx screen where it is not standard, add the letter "V" after the part number when ordering (for example, Part number 253215V).		225



# ShadowBox Clarion

Utilizes a 1 1/2" tubular aluminum frame painted flat black. The viewing surface attaches to the back side of the frame. Hence, the frame is visible and serves as a black border around the perimeter of the image area.

- **Options:** Custom sizes and CinemaScope sizes available by quotation. Vel-Tex, a black, velvety textile covering, is a recommended option that cuts reflection and conceals all trace of joints in the frame. To include Vel-Tex on a ShadowBox Clarion, add the letter "V" after the part number when ordering (for example, Part number 253103V).

CineFlex White XT700V front/rear projection surface is also available at the same price as CineFlex CH1200V. See pages 4 and 5 for viewing surface details. When ordering these surfaces, use the CineFlex CH1200V part number followed by the appropriate suffix: **CD** for CineFlex White XT700V.

ShadowBox Clarion is now available curved, on legs, or with suspension brackets by request - please call for quotation.

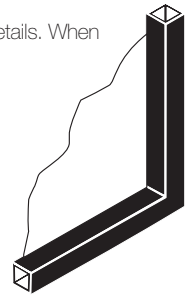

FIXED SCREENS

CHART CONTINUED BELOW

Nom. Diag.	Image Area	Overall Size	OptiFlex Surfaces				Ship Wt./lbs.	Dim Wt./lbs.	Freight Class	
			Matt White XT1000V	Pure White XT1300V	PRICE	Grey XH600V				PRICE
<b>16:10 Format</b>										
94"	50" x 80"	53" x 83"	253124	253124FN	\$1070	253123	\$1129	35	41	85 P+
109"	57 1/2" x 92"	60 1/2" x 95"	253128	253128FN	1325	253127	1397	35	49	85 P+
113"	60" x 96"	63" x 99"	253143	253143FN	1399	253144	1477	36	51	85 P+
123"	65" x 104"	68" x 107"	253132	253132FN	1565	253131	1650	40		85
137"	72 1/2" x 116"	75 1/2" x 119"	253136	253136FN	1812	253135	1910	43		85
165"	87 1/2" x 140"	90 1/2" x 143"	253140	253140FN	2069	253139	2184	55		85
<b>16:9 HDTV Format</b>										
92"	45" x 80"	48" x 83"	253016	253016FN	\$1070	253088	\$1129	35	41	85 P+
100"	49" x 87"	52" x 90"	253115	253115FN	1217	253118	1284	36	45	85 P+
106"	52" x 92"	55" x 95"	253017	253017FN	1325	253089	1397	36	47	85 P+
110"	54" x 96"	57" x 99"	253119	253119FN	1399	253122	1477	37	50	85 P+
119"	58" x 104"	61" x 107"	253097	253097FN	1565	253100	1650	40		85
133"	65" x 116"	68" x 119"	253018	253018FN	1812	253090	1910	46		85
161"	79" x 140"	83" x 143"	253019	253019FN	2069	253091	2184	55		85
193"	95" x 169"	98" x 172"	253103	253103FN	2234	253108	2355	65		85
220"	108" x 192"	111" x 195"	253109	253109FN	2419	253112	2554	80		85
<b>4:3 NTSC Video Format</b>										
6'	43" x 57"	46" x 60"	253008	253008FN	\$738	253080	\$780	29	30	85 P+
6' 6"	47" x 63"	50" x 66"	253009	253009FN	822	253081	867	31	33	85 P+
7'	50" x 67"	53" x 70"	253010	253010FN	865	253082	914	33	35	85 P+
90"	54" x 72"	57" x 75"	253011	253011FN	990	253083	1042	34	38	85 P+
100"	60" x 80"	63" x 83"	253012	253012FN	1069	253084	1127	34	42	85 P+
10'	72" x 96"	75" x 99"	253013	253013FN	1325	253085	1397	42	50	85 P+
150"	90" x 120"	93" x 123"	253014	253014FN	1799	253086	1899	54		85
15'	108" x 144"	111" x 147"	253015	253015FN	2060	253102	2174	65		85

**TECVISION** \*\* To order a screen with a TecVision® surface, the suffix codes should be added to the end of the Matt White XT1000V part number. (Ex. 253124TA for a 94" screen with the TecVision® CS1000X ALR surface.)

See page 6 for full descriptions and formula codes of all available TecVision® surfaces.

Nom. Diag.	Image Area	Overall Size	CineFlex Surface		ClearSound Surface		TecVision® Viewing Surfaces				Ship Wt./lbs.	Dim Wt./lbs.	Freight Class	
			CineFlex CH1200V	PRICE	ClearSound NanoPerf XT1000V	PRICE	TecVision®	PRICE	TecVision® NanoPerf	PRICE				
<b>16:10 Format</b>														
94"	50" x 80"	53" x 83"	253126	\$1264	253124SC	\$1442	253124**	\$1997	253124**	\$2369	35	42	85 P+	
109"	57 1/2" x 92"	60 1/2" x 95"	253130	1564	253128SC	1697	253128**	2551	253128**	2922	35	49	85 P+	
113"	60" x 96"	63" x 99"	253146	1650	253143SC	1770	253143**	2732	253143**	3104	36	51	85 P+	
123"	65" x 104"	68" x 107"	253134	1847	253132SC	1937	253132**	3132	253132**	3504	40		85	
137"	72 1/2" x 116"	75 1/2" x 119"	253138	2139	253136SC	2182	253136**	3759	253136**	4129	43		85	
165"	87 1/2" x 140"	90 1/2" x 143"	253142	2440	253140SC	2440	253140**	4904	253140**	5276	55		85	
<b>16:9 HDTV Format</b>														
92"	45" x 80"	48" x 83"	253064	\$1264	253016SC	\$1442	253016**	\$1904	253016**	\$2275	28	42	85 P+	
100"	49" x 87"	52" x 90"	253117	1435	253115SC	1589	253115**	2204	253115**	2576	32	46	85 P+	
106"	52" x 92"	55" x 95"	253065	1564	253017SC	1697	253017**	2432	253017**	2804	34	48	85 P+	
110"	54" x 96"	57" x 99"	253121	1650	253119SC	1770	253119**	2599	253119**	2971	36	50	85 P+	
119"	58" x 104"	61" x 107"	253099	1847	253097SC	1937	253097**	2962	253097**	3334	40		85	
133"	65" x 116"	68" x 119"	253066	2139	253018SC	2182	253018**	3559	253018**	3929	46		85	
161"	79" x 140"	83" x 143"	253067	2440	253019SC	2440	253019**	4629	253019**	5001	55		85	
193"	95" x 169"	98" x 172"	253107	2636	--	--	253103**	5951	253103**	--	65		85	
220"	108" x 192"	111" x 195"	253111	2854	--	--	253109**	7220	253109**	--	80		85	
<b>4:3 NTSC Video Format</b>														
6'	43" x 57"	46" x 60"	253056	\$872	253008SC	\$1110	253008**	\$1305	253008**	\$1677	29	31	85 P+	
6' 6"	47" x 63"	50" x 66"	253057	970	253009SC	1194	253009**	1509	253009**	1880	31	34	85 P+	
7'	50" x 67"	53" x 70"	253058	1020	253010SC	1237	253010**	1640	253010**	2012	33	36	85 P+	
90"	54" x 72"	57" x 75"	253059	1169	253011SC	1362	253011**	1890	253011**	2262	34	38	85 P+	
100"	60" x 80"	63" x 83"	253060	1260	253012SC	1439	253012**	2180	253012**	2551	34	42	85 P+	
10'	72" x 96"	75" x 99"	253061	1564	253013SC	1697	253013**	2926	253013**	3297	42	50	85 P+	
150"	90" x 120"	93" x 123"	253062	2122	--	--	253014**	4299	253014**	--	54		85	
15'	108" x 144"	111" x 147"	253063	2430	--	--	253015**	5661	--	--	65		85	

### Vel-Tex® for ShadowBox Clarion

PRICE
Vel-Tex® — A velvety black textile that cuts reflections to virtually zero and conceals all trace of joints in the frame. To add Vel-Tex on a ShadowBox Clarion, add the suffix "V" to the part number when ordering.
\$225

For Pricing on Screen material, see page 47.

### Brackets for ShadowBox Clarion

	Part No.	PRICE
Fly Bracket (single)	385225	\$23
Fly Bracket (pair)	385226	45

# Edgeless Clarion

The viewing surface of this product wraps completely around the frame and attaches to the back side. The Edgeless Clarion does not have a border of any kind—from the audience side you see only a solid screen surface. The image area will match the overall size.

• **Options:** Custom sizes and CinemaScope sizes available by quotation.

**Edgeless Clarion is now available curved, on legs, or with suspension brackets by request, please call for quotation.**

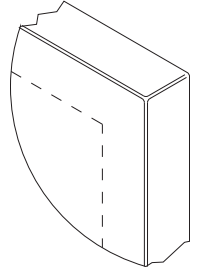

FIXED SCREENS

CHART CONTINUED BELOW

Nom. Diag.	Image Area	Overall Size	OptiFlex Surfaces				Ship Wt./lbs.	Dim Wt./lbs.	Freight Class	
			Matt White XT1000V	Pure White XT1300V	PRICE	Grey XH600V				PRICE
<b>16:10 Format</b>										
85"	45" x 72"	45" x 72"	255023	255023FN	\$1252	255042	\$1322	33	37	85 P+
94"	50" x 80"	50" x 80"	255025	255025FN	1442	255043	1520	34	40	85 P+
109"	57 1/2" x 92"	57 1/2" x 92"	255027	255027FN	1749	255044	1842	35	46	85 P+
113"	60" x 96"	60" x 96"	255049	255049FN	1842	255050	1944	37	48	85 P+
123"	65" x 104"	65" x 104"	255029	255029FN	2059	255045	2170	38	52	85 P+
<b>16:9 HDTV Format</b>										
82"	40 1/2" x 72"	40 1/2" x 72"	255015	255015FN	\$1252	255038	\$1322	33	37	85 P+
92"	45" x 80"	45" x 80"	255017	255017FN	1442	255039	1520	35	42	85 P+
106"	52" x 92"	52" x 92"	255019	255019FN	1749	255040	1842	36	46	85 P+
110"	54" x 96"	54" x 96"	255046	255046FN	1842	255047	1944	37	48	85 P+
119"	58" x 104"	58" x 104"	255021	255021FN	2059	255041	2170	38	52	85 P+
133"	65" x 116"	65" x 116"	255031	255031FN	2450	255033	2582	40		85
<b>4:3 NTSC Video Format</b>										
90"	54" x 72"	54" x 72"	255007	255007FN	\$1490	255034	\$1570	34	37	85 P+
100"	60" x 80"	60" x 80"	255009	255009FN	1722	255035	1819	34	40	85 P+
120"	72" x 96"	72" x 96"	255011	255011FN	2224	255036	2347	42	48	85 P+
132"	78" x 104"	78" x 104"	255013	255013FN	2494	255037	2634	54		85 P+

**TECVISION** \*\* To order a screen with a TecVision® surface, the suffix codes should be added to the end of the Matt White XT1000V part number. (Ex. 2555023TA for a 85" screen with the TecVision® CS1000X ALR surface.)

See page 6 for full descriptions and formula codes of all available TecVision® surfaces.

Nom. Diag.	Image Area	Overall Size	ClearSound Surfaces		TecVision® Surfaces				Ship Wt./lbs.	Dim Wt./lbs.	Freight Class
			ClearSound NanoPerf XT1000V	PRICE	TecVision®	PRICE	TecVision® NanoPerf	PRICE			
<b>16:10 Format</b>											
85"	45" x 72"	45" x 72"	255023SC	2205\$	255023**	\$2002	255023**	\$2956	33	37	85 P+
94"	50" x 80"	50" x 80"	255025SC	2450	255025**	2369	255025**	3377	34	41	85 P+
109"	57 1/2" x 92"	57 1/2" x 92"	255027SC	2781	255027**	2974	255027**	4006	35	47	85 P+
113"	60" x 96"	60" x 96"	255049SC	3024	255049**	3176	255049**	4358	37	49	85 P+
123"	65" x 104"	65" x 104"	255029SC	3214	255029**	3626	255029**	4781	38	53	85 P+
<b>16:9 HDTV Format</b>											
82"	40 1/2" x 72"	40 1/2" x 72"	255015SC	\$2159	255015**	\$1929	255015**	\$2836	33	37	85 P+
92"	45" x 80"	45" x 80"	255017SC	2450	255017**	2275	255017**	3284	35	42	85 P+
106"	52" x 92"	52" x 92"	255019SC	2781	255019**	2856	255019**	3887	36	47	85 P+
110"	54" x 96"	54" x 96"	255046SC	3024	255046**	3042	255046**	4224	37	49	85 P+
119"	58" x 104"	58" x 104"	255021SC	3214	255021**	3456	255021**	4611	38	53	85 P+
133"	65" x 116"	65" x 116"	255031SC	3446	255031**	4198	255031**	5193	40		85
<b>4:3 NTSC Video Format</b>											
90"	54" x 72"	54" x 72"	255007SC	\$2249	255007**	\$2390	255007**	\$3149	34	37	85 P+
100"	60" x 80"	60" x 80"	255009SC	2499	255009**	2834	255009**	3611	34	41	85 P+
120"	72" x 96"	72" x 96"	255011SC	3024	255011**	3824	255011**	4624	42	49	85 P+
132"	78" x 104"	78" x 104"	255013SC	3239	255013**	4373	255013**	5118	54		85 P+

For Pricing on Screen Material see page 47.

### Freight Class Key

Number LTL freight class  
**P** . . . . . Parcel Service  
**+** . . . . . \$15.00 surcharge (over 48" long)

**Example:** a freight code of 125 P+ indicates an item that may ship as freight class 125 or via parcel service with \$15.00 surcharge.

### Brackets for Edgeless Clarion

	Part No.	PRICE
Fly Bracket (single)	385225	\$23
Fly Bracket (pair)	385226	45

# Profile+

The Profile+ fixed projection screen creates the clean, high-tech look of a flat panel screen on your wall, but in larger sizes that are only possible with projection. Its slender frame is less than 5/8" wide and 1 1/2" deep. Features Draper's proprietary surface tensioning system to keep the viewing surface perfectly flat with no puckering. Assembles without snaps. Finished in black. Ships knocked down.

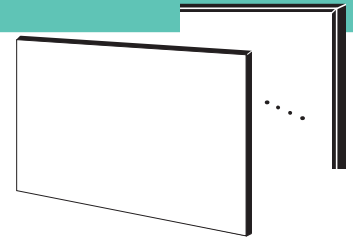

- Custom sizes, by quotation.
- LED Light Kits Available see chart below.
- Also available as a borderless product.

Nom. Diag.	Image Area	Overall Size	OptiFlex Surfaces				ClearSound Surface		Ship Wt./lbs.	Freight Class
			Matt White XT1000V	Pure White XT1300V	Grey XH600V	PRICE	ClearSound NanoPerf XT1000V	PRICE		
<b>16:10 Format</b>										
94"	50" x 80"	51 1/4" x 81 1/4"	254207	254207FN	254224	\$1537	254207SC	\$2721	47	85
109"	57 1/2" x 92"	58 3/4" x 93 1/4"	254208	254208FN	254225	1915	254208SC	3479	53	85
113"	60" x 96"	61 1/4" x 97 1/4"	254209	254209FN	254226	1990	254209SC	3689	56	85
123"	65" x 104"	66 1/4" x 105 1/4"	254210	254210FN	254227	2264	254210SC	4258	63	85
137"	72 1/2" x 116"	73 3/4" x 117 1/4"	254211	254211FN	254228	2616	254211SC	5099	68	85
165"	87 1/2" x 140"	88 3/4" x 141 1/4"	254212	254212FN	254229	2967	254212SC	6583	83	85
198"	105" x 168"	106 1/4" x 169 1/4"	254251	254251FN	254255	3489	--	--	98	85
226"	120" x 192"	121 1/4" x 193 1/4"	254252	254252FN	254256	4523	--	--	114	85
255"	135" x 216"	136 1/4" x 217 1/4"	254253	254253FN	254257	5431	--	--	122	85
283"	150" x 240"	151 1/4" x 241 1/4"	254254	254254FN	254258	6410	--	--	136	85
<b>16:9 HDTV Format</b>										
92"	45" x 80"	46 1/4" x 81 1/4"	254200	254200FN	254217	\$1537	254200SC	\$2601	38	85
100"	49" x 87"	50 1/4" x 88 1/4"	254201	254201FN	254218	1820	254201SC	3081	45	85
106"	52" x 92"	53 1/4" x 93 1/4"	254202	254202FN	254219	1915	254202SC	3331	51	85
110"	54" x 96"	55 1/4" x 97 1/4"	254203	254203FN	254220	1990	254203SC	3522	53	85
119"	58" x 104"	59 1/4" x 105 1/4"	254204	254204FN	254221	2264	254204SC	4044	57	85
133"	65" x 116"	66 1/4" x 117 1/4"	254205	254205FN	254222	2616	254205SC	4843	68	85
161"	79" x 140"	80 1/4" x 141 1/4"	254206	254206FN	254223	2967	254206SC	6235	83	85
193"	94 1/2" x 168"	95 3/4" x 169 1/4"	254263	254263FN	254267	3489	254263SC	8185	85	85
220"	108" x 192"	109 1/4" x 193 1/4"	254264	254264FN	254268	4126	--	--	100	85
248"	121 1/2" x 216"	122 3/4" x 217 1/4"	254265	254265FN	254269	5031	--	--	115	85
275"	135" x 240"	136 1/4" x 241 1/4"	254266	254266FN	254270	5911	--	--	130	85
<b>2.35:1 CinemaScope Format</b>										
115"	45" x 105 3/4"	46 1/4" x 107"	254213	254213FN	254230	\$2067	254213SC	\$3356	57	85
132"	52" x 122"	53 1/4" x 123 1/4"	254214	254214FN	254231	2417	254214SC	4156	68	85
148"	58" x 136 1/4"	59 1/4" x 137 1/2"	254215	254215FN	254232	2874	254215SC	5208	83	85
166"	65" x 152 3/4"	66 1/4" x 154"	254216	254216FN	254233	3307	254216SC	6241	83	85
204"	80" x 188"	81 1/4" x 189 1/4"	254275	254275FN	254279	4126	254275SC	8575	95	85
230"	90" x 211 1/2"	91 1/4" x 212 3/4"	254276	254276FN	254280	5031	254276SC	10710	111	85
248"	97" x 228"	98 1/4" x 229 1/4"	254277	254277FN	254281	5211	254277SC	11751	119	85
260"	101 3/4" x 239 1/4"	103" x 240 1/2"	254278	254278FN	254282	5911	--	--	133	85

CHART CONTINUED BELOW



\*\* To order a screen with a TecVision® surface, the suffix codes should be added to the end of the Matt White XT1000V part number. See page 6 for full descriptions and formula codes of all available TecVision® surfaces.

Nom. Diag.	Image Area	Overall Size	TecVision® Viewing Surfaces			
			TecVision®	PRICE	TecVision® NanoPerf	PRICE
<b>16:10 Format</b>						
94"	50" x 80"	51 1/4" x 81 1/4"	254207**	\$2464	254207**	\$3647
109"	57 1/2" x 92"	58 3/4" x 93 1/4"	254208**	3141	254208**	4704
113"	60" x 96"	61 1/4" x 97 1/4"	254209**	3324	254209**	5023
123"	65" x 104"	66 1/4" x 105 1/4"	254210**	3831	254210**	5824
137"	72 1/2" x 116"	73 3/4" x 117 1/4"	254211**	4563	254211**	7046
165"	87 1/2" x 140"	88 3/4" x 141 1/4"	254212**	5803	254212**	9419
198"	105" x 168"	106 1/4" x 169 1/4"	254251**	7573	--	--
226"	120" x 192"	121 1/4" x 193 1/4"	254252**	9857	--	--
255"	135" x 216"	136 1/4" x 217 1/4"	254253**	12182	--	--
283"	150" x 240"	151 1/4" x 241 1/4"	254254**	14745	--	--
<b>16:9 HDTV Format</b>						
92"	45" x 80"	46 1/4" x 81 1/4"	254200**	\$2370	254200**	\$3434
100"	49" x 87"	50 1/4" x 88 1/4"	254201**	2807	254201**	4067
106"	52" x 92"	53 1/4" x 93 1/4"	254202**	3022	254202**	4438
110"	54" x 96"	55 1/4" x 97 1/4"	254203**	3191	254203**	4723
119"	58" x 104"	59 1/4" x 105 1/4"	254204**	3661	254204**	5441
133"	65" x 116"	66 1/4" x 117 1/4"	254205**	4363	254205**	6590
161"	79" x 140"	80 1/4" x 141 1/4"	254206**	5528	254206**	8795
193"	94 1/2" x 168"	95 3/4" x 169 1/4"	254263**	7166	254263**	11862
220"	108" x 192"	109 1/4" x 193 1/4"	254264**	8927	--	--
248"	121 1/2" x 216"	122 3/4" x 217 1/4"	254265**	11104	--	--
275"	135" x 240"	136 1/4" x 241 1/4"	254266**	13413	--	--
<b>2.35:1 CinemaScope Format</b>						
115"	45" x 105 3/4"	46 1/4" x 107"	254213**	\$3169	254213**	\$4458
132"	52" x 122"	53 1/4" x 123 1/4"	254214**	3886	254214**	5624
148"	58" x 136 1/4"	59 1/4" x 137 1/2"	254215**	4701	254215**	7035
166"	65" x 152 3/4"	66 1/4" x 154"	254216**	5608	254216**	8542
204"	80" x 188"	81 1/4" x 189 1/4"	254275**	7610	254275**	12059
230"	90" x 211 1/2"	91 1/4" x 212 3/4"	254276**	9437	254276**	15116
248"	97" x 228"	98 1/4" x 229 1/4"	254277**	10329	--	--
260"	101 3/4" x 239 1/4"	103" x 240 1/2"	254278**	11549	--	--

### LED Light Kit Sizes

Nom. Diag. Viewing Surface	LED KIT
92"-148"	Small
161"-204"	Medium
220"-283"	Large

### Full LED Light Kits

Part Number	Description	PRICE
C041.078	<b>SMALL LED KIT-</b> IR 44 button Remote, Sony Battery, 12V-6A Power Supply with right angle cord, TWO RGB 5M LED strips.	\$488
C041.079	<b>MEDIUM LED KIT-</b> IR 44 button Remote, Sony Battery, 12V-6A Power Supply with right angle cord, TWO RGB 7.5M LED strips.	535
C041.080	<b>LARGE LED KIT-</b> IR 44 button Remote, Sony Battery, 12V-10A Power Supply with right angle cord, TWO RGB 10M LED strips.	585

### LED Light Kit Single Components

Part Number	Description	PRICE
C041.072	Single 5M LED Strip w/Black PCB	\$147
C041.073	Single 7.5M LED Strip w/Black PCB	225
C041.074	Single 10M LED Strip w/Black PCB	293
C041.075	Extra IR 44 Button Remote for LED Kit	103
C041.076	Extra LED Power Supply for LED Kit. I/P:100-240VAC, 12V6A, CE/FCC cert	98
C041.077	Extra LED Power Supply for LED Kit. I/P:100-240VAC, 12V10A, UL/CE/FCC cert	147

### Custom Fly Brackets for Profile+

	Part No.	PRICE
Fly Bracket (single)	254287	\$43
Fly Bracket (pair)	254288	75

# Lace & Grommet

Draper's Lace & Grommet projection screen is versatile, wall-mounted, and ideal for use in blending, multiformat, and curved applications. It includes a 3" powder coated aluminum frame (black standard) and unique wall mounting brackets used for either flat or curved applications. One of the greatest features of our Lace & Grommet screen is its simple and secure assembly. The frame sections attach with quick connectors while bungees ship laced and attached to the frame. This removes the tedious process of lace threading and ensures the install will be that much easier.

- **Options:** Custom sizes, up to 100' wide, available by quotation. Decorative trim available featuring rigid PVC with IFR (Inherently Flame Retardant) Velour in black finish.



## Lace & Grommet Screen Pricing

Prices per square foot, based on overall size, including 4" black webbing border.  
**Lacing Cord** and **Bungee Cord** available at additional cost.

FIXED SCREENS

Prices per square foot	Maximum Size	PRICE
<b>OptiFlex (Flexible)</b>		
Grey XH600V	27' x 100'	\$12.20
Matt White XT1000V	27' x 100'	11.40
Pure White XT1300V	27' x 100'	15.70
<b>TecVision®</b>		
All Formulations	22' H x 69' W	\$40.50
<b>TecVision® with NanoPerf*</b>		
All Formulations	100" H x 69' W	\$49.50

\*Standard perforation available at the same price as NanoPerf.

Please note: There is a 10% upcharge for any surface that exceeds 60' in wide or 20' high.

Prices per square foot	Maximum Size	PRICE
<b>CineFlex (Rear/Dual Projection)</b>		
CineFlex White XT700V	27' x 60'	\$15.40
CineFlex CH1200	27' x 60'	15.40
<b>ClearSound (Acoustically Transparent)</b>		
ClearSound NanoPerf XT1000V	100" x 100'	\$18.90
<b>Chroma Key</b>		
Chroma Key Green	27' x 100'	\$14.90

Accessories for Lace & Grommet	Part No.	PRICE
Wall Mount Bracket (Single)	C002.987SA	\$44
Telescoping Wall Bracket (Single)	C041.057	68
Lace and Grommet Accessory Kit - Includes (5) Bungee Cord Guides, (4) S Hooks, (2) Red Knobs, and 10' of Bungee Cord.	383832	56

Please note: Lace and Grommet frames cannot exceed 22' in a suspended application. Frames cannot exceed 28' high for wall mounts. Surface can only be made to shown maximum sizes.

## Frame Pricing

Price per lineal foot	PRICE
<b>Frame</b>	
Flat Frame	\$69
Curved Frame	87
<b>Trim</b>	
Soft - IFR Velour (black)	\$34

**Fly cages and stackers can easily mount your large venue projectors to trusses using cheeseborough clamps. Check out Draper's new fly cages on page 91!**

# Portable Projection Screens

## Folding and Modular Screens

**StageScreen®**—Fly it or use it with legs. The StageScreen is the strongest and most rigid screen on the market. Available in silver anodized or black frame finish. The 8" truss frame is completely modular. All available sizes of StageScreen are built from combinations of the same 6 standard color-coded frame sections (including optional legs). If a frame section should ever become lost or damaged you can replace it in seconds without tools. Standard sizes through 60' wide. Custom sizes available by quotation. 24' Maximum width with legs.

**FocalPoint®**—With 4" modular frame segments made of sturdy extruded aluminum, the FocalPoint is extremely rigid and durable, while remaining lightweight. With no hinges, the FocalPoint is strong, and still features quick and easy assembly. All available sizes are built from combinations of the same frame segments. Included screen legs are also constructed using these frame segments. Available in both Black and Silver Anodized frame finish. Sizes through 20' wide.

**Ultimate Folding Screen**—The Ultimate Folding Screen is the first screen manufactured with 100% CNC (Computer Numerical Controlled) components and assembly. The tubing is CNC machined, surfaces and borders are CNC cut; even rivet and snap holes are CNC placed. No competitive product meets this standard. Available in both Black and Silver Anodized frame finish. Sizes through 16' wide.

**Cinefold**—Portable folding screen in a wide range of sizes: through 14' wide with standard construction or 30' wide as **Truss Cinefold**. Available with interchangeable front and rear projection surfaces. Molded polyethylene case comes complete with wheels.

## Traveller

Sets up in seconds on floor or table. The Traveller features an infinitely adjustable telescoping mast that tensions screen in desired position. Upright stores in case. Detachable shoulder strap included. Features black extruded aluminum case with black powder coat finish.

- **Black Borders:** Includes ¾" black borders and 30" black "rise".
- **Options:** Padded carrying case with zipper and removable heavy nylon shoulder strap.

Nom. Diag.	Image Area	OptiView Viewing Surfaces							Case Length	Ship Wt./lbs.	Dim Wt./lbs.	Freight Class
		Matt White XT1000E	PRICE	Contrast Grey XH800E	Contrast White XH1100E	Argent White XH1500E	Pearl White CH1900E	PRICE				
<b>16:10 Format</b>												
47"	25" x 40"	230135	\$614	230140	230135EG	230135EH	230135EJ	\$644	46 ½"	16	19	85 P
57"	30" x 48"	230136	636	230141	230136EG	230136EH	230136EJ	670	54 ½"	17	22	85 P
68 ½"	36 ¼" x 58"	230137	702	230142	230137EG	230137EH	230137EJ	738	64"	21	26	85 P+
76"	40" x 64"	230138	778	230143	230138EG	230138EH	230138EJ	818	70 ½"	24	29	85 P+
94"	50" x 80"	230139	918	230144	230139EG	230139EH	230139EJ	964	86 ½"	31	35	85 P+
<b>16:9 HDTV Format</b>												
46"	22 ½" x 40"	230116	\$614	230126	230116EG	230116EH	230116EJ	\$644	46 ½"	16	19	85 P
55"	27" x 48"	230117	636	230127	230117EG	230117EH	230117EJ	670	54 ½"	17	22	85 P
66 ½"	32 ½" x 58"	230118	702	230128	230118EG	230118EH	230118EJ	738	64"	21	26	85 P+
73"	36" x 64"	230119	778	230129	230119EG	230119EH	230119EJ	818	70 ½"	24	29	85 P+
92"	45" x 80"	230120	918	230130	230120EG	230120EH	230120EJ	964	86 ½"	27	35	85 P+
<b>4:3 NTSC Video Format</b>												
50"	30" x 40"	230101	\$614	230111	230101EG	230101EH	230101EJ	\$644	46 ½"	16	19	85 P
60"	36" x 48"	230103	636	230112	230103EG	230103EH	230103EJ	670	54 ½"	19	23	85 P
72"	43 ½" x 58"	230105	702	230113	230105EG	230105EH	230105EJ	738	64"	21	26	85 P+
80"	48" x 64"	230107	778	230114	230107EG	230107EH	230107EJ	818	70 ½"	24	28	85 P+
100"	60" x 80"	230109	918	230115	230109EG	230109EH	230109EJ	964	86 ½"	31	35	85 P+

## Padded Carrying Cases for Traveller

Nom. Diag.	Image Area	Height Range (set up)	Closed Dimensions (D x H x L)	Part No.	PRICE	Carrying Case Length	Ship Wt./lbs.	Dim Wt./lbs.	Freight Class
<b>16:10 Format</b>									
47"	25" x 40"	30" - 60"	4 ½" x 5" x 46 ½"	C091.019	\$144	50"	3	10	70 P
57"	30" x 48"	35" - 65"	4 ½" x 5" x 54 ½"	230058	154	60"	3	10	70 P
68 ½"	36 ¼" x 58"	41 ¼" - 71 ¼"	4 ½" x 5" x 64"	C091.020	162	72"	4	10	70 P
76"	40" x 64"	45" - 75"	4 ½" x 5" x 70 ½"	C091.023	170	80"	4	11	70 P
94"	50" x 80"	55" - 85"	4 ½" x 5" x 86 ½"	C091.021	194	100"	4	11	85 P
<b>16:9 HDTV Format</b>									
46"	22 ½" x 40"	27 ½" - 57 ½"	4 ½" x 5" x 46 ½"	C091.019	\$144	50"	3	10	70 P
55"	27" x 48"	32" - 62"	4 ½" x 5" x 54 ½"	230058	154	60"	3	10	70 P
66 ½"	32 ½" x 58"	37 ½" - 67 ½"	4 ½" x 5" x 64"	C091.020	162	72"	4	10	70 P
73"	36" x 64"	41" - 71"	4 ½" x 5" x 70 ½"	C091.023	170	80"	4	11	70 P
92"	45" x 80"	50" - 80"	4 ½" x 5" x 86 ½"	C091.021	194	100"	4	11	85 P
<b>4:3 NTSC Video Format</b>									
50"	30" x 40"	35" - 65"	4 ½" x 5" x 46 ½"	C091.019	\$144	50"	3	10	70 P
60"	36" x 48"	41" - 71"	4 ½" x 5" x 54 ½"	230058	154	60"	3	10	70 P
72"	43 ½" x 58"	48 ½" - 78 ½"	4 ½" x 5" x 64"	C091.020	162	72"	4	10	70 P
80"	48" x 64"	53" - 83"	4 ½" x 5" x 70 ½"	C091.023	170	80"	4	11	70 P
100"	60" x 80"	65" - 95"	4 ½" x 5" x 86 ½"	C091.021	194	100"	4	11	85 P

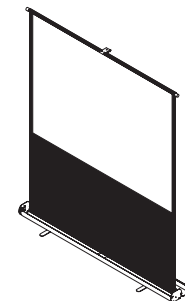

**Replacement Traveller Telescopic Upright Pole**

Part No.	For Screens	PRICE
400520	60" and smaller	\$130
400521	Over 60"	140

# Luma 2/R Screen for use with Floor Stand

Spring-roller operated heavy duty screen, inverted and cradled in a floor stand (sold separately). **Floor Stand is required in order to operate Luma 2/R correctly.** Case is scratch-resistant black finished steel (plastisol) or covered with black carpet. Viewing surface is Matt White XT1000E.

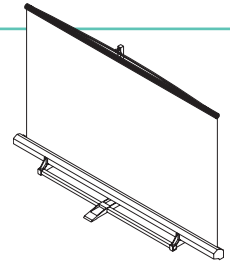

- **Sizes and Formats:** Custom sizes available by quotation. Custom sizes need to be specified in detail, including extra rise, if desired.
- **Options:** 2" wide black borders on AV format screens, no extra charge on request.

H x W / Diagonal	Image Area	Overall Size	Matt White XT1000E				Case Length	Ship Wt./lbs.	Dim Wt./lbs.	Freight Class
			Black Plastisol Case		Black Carpeted Case					
			Part No.	PRICE	Part No.	PRICE				
<b>4:3 NTSC Video Format</b>										
10'	69" x 92"	73" x 96"	211009	\$684	211021	\$882	98 5/8"	39	68	85 P+
11'	78" x 104"	83" x 108"	211010	882	211022	1130	111 1/4"	45		85
150"	87" x 116"	92" x 120"	211011	1076	211023	1380	123 1/4"	50		85
15'	105" x 140"	109" x 144"	211012	1412	211024	1672	147 1/4"	100		85
<b>AV Format</b>										
72" x 96"			211001	\$684	211013	\$882	98 5/8"	39	68	85 P+
96" x 96"			211002	728	211014	938	98 5/8"	41	68	85 P+
7' x 9'			211003	882	211015	1130	111"	45		85
9' x 9'			211004	1086	211016	1384	111"	48		85
8' x 10'			211005	1186	211017	1404	123 1/4"	50		85
10' x 10'			211006	1260	211018	1578	123 1/4"	64		85
9' x 12'			211007	1412	211019	1672	147 1/4"	75		85
12' x 12'			211008	1520	211020	1764	147 1/4"	86		85

## Floor Stand

Sturdy support for Luma 2/R. Screen case rests in "cradle"; viewing surface pulls up. Adjustable upright permits square-format screens to be used in movie, NTSC and slide formats. **Floor Stand is required in order to operate Luma 2/R correctly.**

Part No.	PRICE	Shipping Wt./lbs.	Freight Class
212001	\$708	25	85 P+

PORTABLE SCREENS

## Skirts for Mobile AV Carts and Tables

Removable skirts include hook and loop for instant attachment. Loop side is attached to the skirt with hook side on the cart. Three fabrics: 10 oz. Poly-Knit satiny polyester, 12 oz. Classic Twill wrinkle-resistant polyester and 12 oz. Vellite brushed polyester with a crushed appearance.

- **Colors:** Poly-Knit and Vellite are available in Navy or Black. Classic Twill is available in Navy or Black, other colors available on request.

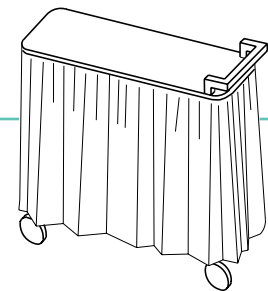

Cart Size H x W x L	Skirt Size H x W	No. of Sides	Black Poly-Knit		Black Classic Twill		Black Vellite		Freight Class
			Part No.	PRICE	Part No.	PRICE	Part No.	PRICE	
26" x 18" x 24"	22" x 84"	4	C168.194	\$51	C168.222	\$71	C168.166	\$71	70 P
34" x 18" x 24"	30" x 84"	4	C168.195	54	C168.223	72	C168.167	89	70 P
42" x 18" x 24"	38" x 84"	4	C168.196	65	C168.224	92	C168.168	96	70 P
42" x 25" x 30"	38" x 94"	3	C168.197	83	C168.225	104	C168.169	107	70 P
	38" x 110"	4	C168.198	92	C168.226	104	C168.170	126	70 P
48" x 25" x 30"	38" x 116"	4	C168.199	95	C168.227	131	C168.171	138	70 P
	44" x 94"	3	C168.200	90	C168.228	129	C168.172	111	70 P
48" x 25" x 30"	44" x 110"	4	C168.201	96	C168.229	149	C168.173	132	70 P
	44" x 116"	4	C168.202	102	C168.230	162	C168.174	140	70 P
54" x 25" x 30"	50" x 94"	3	C168.203	89	C168.231	132	C168.175	101	70 P
	50" x 110"	4	C168.204	104	C168.232	150	C168.176	119	70 P
#203-56	50" x 116"	4	C168.205	111	C168.233	165	C168.177	138	70 P
	56" x 65"	4	C168.206	119	C168.234	195	C168.178	147	70 P
#425	56" x 86"	4	C168.207	159	C168.235	266	C168.179	159	70 P

Available on request: 1) Custom sizes (no minimum order); 2) 100% cotton Velour.

# Diplomat R

A tripod screen designed primarily with special modifications for the audiovisual rental market. Steel case is finished in baked-on black plastisol or black carpeting. Viewing surfaces from the OptiView family. **The Diplomat/R has gone through rigorous testing and is stronger and more durable than ever before. The strengthened internal roller mechanism and steel end caps handle the rigors of carrying a portable screen.**

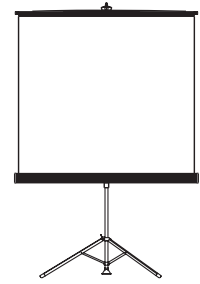

- **Black Borders:** NTSC, HDTV, and 16:10 formats have image area framed with black on all four sides. Black side borders are available on request for AV format screens.
- **Options:** Additional viewing surfaces and formats available by request.

H x W / Diagonal	Image Area	Overall Size	Black Plastisol Case – OptiView Surface		Black Carpeted Case – OptiView Surface		Optional Carrying Case		Case Length	Shipping Wt./lbs.	Freight Class
			Matt White XT1000E	PRICE	Matt White XT1000E	PRICE	Part No.	PRICE			
<b>16:10 Format</b>											
67"	35 1/2" x 56 1/2"	39 1/2" x 59 1/2"	215021	\$364	--	--	214002	\$60	70 1/2"	33	85 P+
78"	41 1/2" x 66 1/2"	45" x 69 1/2"	215022	398	--	--	214003	64	72 1/4"	38	85 P+
94"	50" x 80"	54" x 83 1/2"	215023	510	--	--	214004	80	92"	44	85 P+
109"	57 1/2" x 92"	61 1/2" x 96"	215024	548	--	--	214005	82	104"	47	85 P+
<b>16:9 HDTV Format</b>											
65"	31 1/2" x 56 1/2"	34 1/2" x 59 1/2"	215029	\$364	--	--	214002	\$60	70 1/2"	33	85 P+
76"	37 1/2" x 66 1/2"	41 1/2" x 69 1/2"	215030	398	--	--	214003	64	72 1/4"	38	85 P+
92"	45" x 80"	49" x 83 1/2"	215031	510	--	--	214004	80	92"	42	85 P+
106"	51 1/2" x 92"	55 1/2" x 96"	215032	552	--	--	214005	82	104"	47	85 P+
<b>4:3 NTSC Video Format</b>											
6'	42 1/2" x 56 1/2"	46 1/2" x 59 1/2"	215007	\$364	215017	\$430	214002	\$60	70 1/2"	33	85 P+
7'	50" x 66 1/2"	53 1/2" x 69 1/2"	215008	398	215018	470	214003	64	72 1/4"	38	85 P+
100"	60" x 80"	64" x 83 1/2"	215009	504	215019	614	214004	80	92"	44	85 P+
10'	69" x 92"	73" x 96"	215010	548	215020	678	214005	82	104"	47	85 P+
<b>AV Format</b>											
50" x 50"			215001	\$336	215011	\$400	214001	\$58	57 1/2"	28	85 P+
60" x 60"			215002	364	215012	430	214002	60	70 1/2"	33	85 P+
70" x 70"			215003	398	215013	470	214003	64	72 1/4"	38	85 P+
84" x 84"			215004	510	215014	628	214004	80	92"	44	85 P+
72" x 96"			215005	538	215015	656	214005	82	104"	47	85 P+
96" x 96"			215006	628	215016	770	214005	82	104"	49	85 P+

PORTABLE SCREENS

## Skirts for Diplomat R

All skirts are 38" high and attach with hook and loop (supplied). Loop side of attachment is standard on skirt, with adhesive hook strip included for attachment to screen case. If hook side is required to be attached to skirt, please call Draper.

- **Vellite and Poly-Knit colors:** Navy or Black.
- **Classic Twill colors:** Navy or Black, other colors available on request.

Screen Size H x W	Screen Size Diag.	Skirt Size H x W	Black Poly-Knit		Black Classic Twill		Black Vellite		Freight Class
			Part No.	PRICE	Part No.	PRICE	Part No.	PRICE	
50" x 50"	—	38" x 53"	C168.156	\$63	C168.001	\$72	C168.146	\$84	70 P
60" x 60"	6'	38" x 63"	C168.157	66	C168.030	75	C168.147	86	70 P
70" x 70"	7'	38" x 73"	C168.158	74	C168.059	92	C168.148	105	70 P
84" x 84"	100"	38" x 87"	C168.159	84	C168.088	105	C168.149	129	70 P
72" x 96"	10'	38" x 99"	C168.160	104	C168.117	128	C168.150	147	70 P

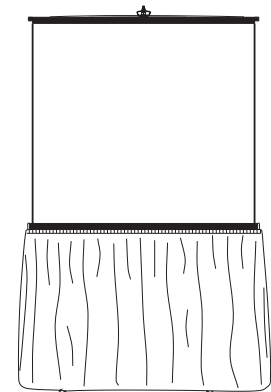

# StageScreen®

Fly it or use it with legs. The StageScreen® is the strongest and most rigid screen on the market. Available in silver anodized or black frame finish.

The 8" truss frame is completely modular. All available sizes of StageScreen® are built from combinations of the same 6 standard color-coded frame sections (including optional legs). If a frame section should ever become lost or damaged, you can replace it in seconds without tools.

A complete StageScreen® consists of frame, viewing surface with pouch, an appropriate number of protective floor tarps and carrying cases. The leg packages include 2 legs, clamps to attach legs to frame, and any necessary additional carrying cases. Legs are made up of the same pieces that make the frame.

All viewing area sizes are exact true format. Custom sizes available—call for quotation. Freight Class: 85

## Viewing Surface Attachment

The viewing surface attaches quickly and easily with the attached DuraLoop™ bungees and handy nylon pull-tabs. Simply hook the surface to the posts on the frame.

## Carrying Case

A wheeled heavy-duty polyethylene carrying case is included.

## Viewing Surfaces

The viewing surface is stretched perfectly flat, resulting in the highest picture quality. Standard viewing surfaces include Black-Backed Matt White XT1000VB—the perfect matt white diffusing surface; or CineFlex CH1200V—A neutral grey for rear projection. CineFlex White XT700V front/rear projection surface is also available. See page 5 for viewing surface details.

## StageScreen Planning

Do you need a complete screen? Follow these steps to help find the right pricing in the charts on the following pages:

1. Choose your frame finish (silver anodized or black).
2. Choose your viewing surface (Black-Backed XT1000VB, CineFlex CH1200V or CineFlex White XT700V).
3. Add legs if needed.

Do you need multiple sizes from one kit? You can also utilize our easy online StageScreen® configurator by visiting [DraperInc.com/DraperPRO](http://DraperInc.com/DraperPRO), or call 800.989.0112 for assistance.

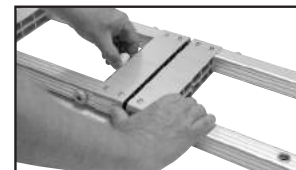
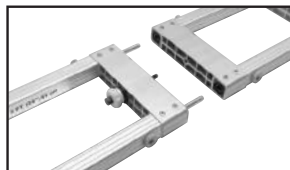
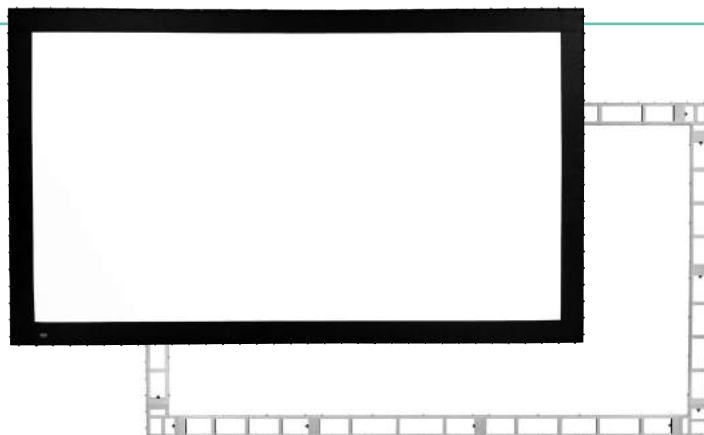

PORTABLE SCREENS

### TecVision Surfaces

Image Area (feet)	Image Area (Inches)	Diagonal	Overall Size	TecVision	Price
<b>16:10 Format</b>					
5' x 8'	60" x 96"	113"	76 1/2" x 112 1/2"	383163**	\$1985
6' 3" x 10'	75" x 120"	142"	94 1/2" x 136 1/2"	383164**	2771
7' 6" x 12'	90" x 144"	170"	106 1/2" x 160 1/2"	383165**	3674
8' 9" x 14'	105" x 168"	198"	124 1/2" x 184 1/2"	383166**	4826
10' x 16'	120" x 192"	226"	136 1/2" x 208 1/2"	383167**	6227
11' 3" x 18'	135" x 216"	255"	154 1/2" x 232 1/2"	383168**	8042
12' 6" x 20'	150" x 240"	283"	166 1/2" x 256 1/2"	383169**	9963
15' x 24'	180" x 288"	340"	196 1/2" x 304 1/2"	383170**	13778
18' 9" x 30'	225" x 360"	425"	244 1/2" x 376 1/2"	383171**	22203
25' x 40'	300" x 480"	566"	316 1/2" x 496 1/2"	383172**	39479
<b>16:9 HDTV Format</b>					
4' 6" x 8'	54" x 96"	110"	70 1/2" x 112 1/2"	383153**	\$1844
5' 7 1/2" x 10'	67 1/2" x 120"	138"	88 1/2" x 136 1/2"	383154**	2568
6' 9" x 12'	81" x 144"	165"	100 1/2" x 160 1/2"	383155**	3386
7' 10 1/2" x 14'	94 1/2" x 168"	193"	112 1/2" x 184 1/2"	383156**	4385
9' x 16'	108" x 192"	220"	124 1/2" x 208 1/2"	383157**	5685
10' 1 1/2" x 18'	121 1/2" x 216"	248"	142 1/2" x 232 1/2"	383158**	7436
11' 3" x 20'	135" x 240"	275"	154 1/2" x 256 1/2"	383159**	9144
13' 6" x 24'	162" x 288"	330"	178 1/2" x 304 1/2"	383160**	12549
16' 10 1/2" x 30'	202 1/2" x 360"	413"	220 1/2" x 376 1/2"	383161**	20075
22' 6" x 40'	270" x 480"	551"	286 1/2" x 496 1/2"	383162**	35693
<b>4:3 NTSC Video Format</b>					
6' x 8'	72" x 96"	120"	88 1/2" x 112 1/2"	383143**	\$2271
7' 6" x 10'	90" x 120"	150"	106 1/2" x 136 1/2"	383144**	3185
9' x 12'	108" x 144"	180"	124 1/2" x 160 1/2"	383145**	4280
10' 6" x 14'	126" x 168"	210"	142 1/2" x 184 1/2"	383146**	5915
12' x 16'	144" x 192"	240"	160 1/2" x 208 1/2"	383147**	7409
13' 6" x 18'	162" x 216"	270"	178 1/2" x 232 1/2"	383148**	9378
15' x 20'	180" x 240"	300"	196 1/2" x 256 1/2"	383149**	11679
18' x 24'	216" x 288"	360"	232 1/2" x 304 1/2"	383150**	16359
22' 6" x 30'	270" x 360"	450"	286 1/2" x 376 1/2"	383151**	27627
<b>MultiFormat</b>					
12' x 40'	144" x 480"	501"	160 1/2" x 496 1/2"	383173**	\$18948
15' x 50'	180" x 600"	626"	196 1/2" x 616 1/2"	383174**	29613
18' x 60'	216" x 720"	752"	232 1/2" x 736 1/2"	383175**	42644



\*\* To order a screen with a TecVision surface, the suffix codes should be added to the end of the Matt White XT1000V part number. (Ex. 383163TA for a 113" screen with the TecVision CS1000X ALR surface.) See page 6 for full descriptions and formula codes of all available TecVision surfaces.

**NOTE: TecVision surfaces cannot be folded and must be rolled on a core for transportation and storage.**

### Freight Class Key

Number LTL freight class  
**P** . . . . . Parcel Service  
**+** . . . . . \$15 surcharge (over 48" long)

**Example:** a freight code of 125 P+ indicates an item that may ship as freight class 125 or via parcel service with \$15 surcharge.



# StageScreen® with Black Frame & Black-Backed Matt White XT1000VB Front Projection Surface

Sewn white borders are optionally available—add 5% to the cost of the surface.

**Silver Anodized Frames and components are also available. Call for a quote!**

Image Area (Feet)	Image Area (Inches)	Diagonal	Overall Size	Frame, Surface, and Case(s)			Optional Black Legs (pr.)			Surface Only	
				Part No.	PRICE	Ship Wt./ lbs.	Part No.	Leg Kit	PRICE	Part No.	PRICE
<b>16:10 Format</b>											
5' x 8'	60" x 96"	113"	76 1/2" x 112 1/2"	383504	\$3485	89	383785	A	\$3750	383163	\$785
6' 3" x 10'	75" x 120"	142"	94 1/2" x 136 1/2"	383505	4050	119	383785	A	3750	383164	896
7' 6" x 12'	90" x 144"	170"	106 1/2" x 160 1/2"	383506	4821	151	383785	A	3750	383165	974
8' 9" x 14'	105" x 168"	198"	124 1/2" x 184 1/2"	383507	5444	163	383786	B	4065	383166	1151
10' x 16'	120" x 192"	226"	136 1/2" x 208 1/2"	383508	5826	238	383786	B	4065	383167	1427
11' 3" x 18'	135" x 216"	255"	154 1/2" x 232 1/2"	383509	6543	191	383787	C	4383	383168	1967
12' 6" x 20'	150" x 240"	283"	166 1/2" x 256 1/2"	383510	7131	272	383787	C	4383	383169	2463
15' x 24'	180" x 288"	340"	196 1/2" x 304 1/2"	383511	7905	369	383788	D	5547	383170	2978
18' 9" x 30'	225" x 360"	425"	244 1/2" x 376 1/2"	383512	11622	485	—	—	—	383171	5328
25' x 40'	300" x 480"	566"	316 1/2" x 496 1/2"	383513	17454	644	—	—	—	383172	9479
<b>16:9 HDTV Format</b>											
4' 6" x 8'	54" x 96"	110"	70 1/2" x 112 1/2"	383494	\$3444	160	383785	A	\$3750	383153	\$764
5' 7 1/2" x 10'	67 1/2" x 120"	138"	88 1/2" x 136 1/2"	383495	3783	175	383785	A	3750	383154	882
6' 9" x 12'	81" x 144"	165"	100 1/2" x 160 1/2"	383496	4020	210	383785	A	3750	383155	956
7' 10 1/2" x 14'	94 1/2" x 168"	193"	112 1/2" x 184 1/2"	383497	4736	218	383785	A	3750	383156	1076
9' x 16'	108" x 192"	220"	124 1/2" x 208 1/2"	383498	5739	232	383786	B	4065	383157	1365
10' 1 1/2" x 18'	121 1/2" x 216"	248"	142 1/2" x 232 1/2"	383499	6278	268	383786	B	4065	383158	1971
11' 3" x 20'	135" x 240"	275"	154 1/2" x 256 1/2"	383500	7025	324	383787	C	4383	383159	2394
13' 6" x 24'	162" x 288"	330"	178 1/2" x 304 1/2"	383501	7716	347	383787	C	4383	383160	2829
16' 10 1/2" x 30'	202 1/2" x 360"	413"	220 1/2" x 376 1/2"	383502	11228	453	—	—	—	383161	4883
22' 6" x 40'	270" x 480"	551"	286 1/2" x 496 1/2"	383503	16916	594	—	—	—	383162	8693
<b>4:3 NTSC Video Format</b>											
6' x 8'	72" x 96"	120"	88 1/2" x 112 1/2"	383484	\$3597	114	383785	A	\$3750	383143	\$831
7' 6" x 10'	90" x 120"	150"	106 1/2" x 136 1/2"	383485	4154	145	383785	A	3750	383144	935
9' x 12'	108" x 144"	180"	124 1/2" x 160 1/2"	383486	5007	157	383786	B	4065	383145	1040
10' 6" x 14'	126" x 168"	210"	142 1/2" x 184 1/2"	383487	5805	201	383786	B	4065	383146	1505
12' x 16'	144" x 192"	240"	160 1/2" x 208 1/2"	383488	6150	228	383787	C	4383	383147	1649
13' 6" x 18'	162" x 216"	270"	178 1/2" x 232 1/2"	383489	6780	244	383787	C	4383	383148	2088
15' x 20'	180" x 240"	300"	196 1/2" x 256 1/2"	383490	7440	350	383788	D	5547	383149	2679
18' x 24'	216" x 288"	360"	232 1/2" x 304 1/2"	383491	8544	393	383788	D	5547	383150	3399
22' 6" x 30'	270" x 360"	450"	286 1/2" x 376 1/2"	383492	13931	501	—	—	—	383151	7377
<b>MultiFormat</b>											
12' x 40'	144" x 480"	501"	160 1/2" x 496 1/2"	383514	\$12737	487	—	—	—	383173	\$4548
15' x 50'	180" x 600"	626"	196 1/2" x 616 1/2"	383515	15831	552	—	—	—	383174	7113
18' x 60'	216" x 720"	752"	232 1/2" x 736 1/2"	383516	19818	647	—	—	—	383175	10244

# StageScreen® with Black Frame & CineFlex CH1200V Rear Projection Surface

CineFlex White XT700V front/rear projection surface is also available at the same price as CineFlex CH1200V.  
 See page 5 for viewing surface details. When ordering use the CineFlex CH1200V part number followed by the suffix:  
**CD** for CineFlex White XT700V. Sewn white borders are optionally available—add 5% to the cost of the surface.

**Silver Anodized Frames and components are also available. Call for a quote!**

PORTABLE SCREENS

Image Area (Feet)	Image Area (Inches)	Diagonal	Overall Size	Frame, Surface, and Case(s)			Optional Black Legs (pr.)			Surface Only	
				Part No.	PRICE	Ship Wt./ lbs.	Part No.	Leg Kit	PRICE	Part No.	PRICE
<b>16:10 Format</b>											
5' x 8'	60" x 96"	113"	76 1/2" x 112 1/2"	383570	\$4007	89	383785	A	\$3750	383196	\$902
6' 3" x 10'	75" x 120"	142"	94 1/2" x 136 1/2"	383571	4658	119	383785	A	3750	383197	1031
7' 6" x 12'	90" x 144"	170"	106 1/2" x 160 1/2"	383572	5544	151	383785	A	3750	383198	1119
8' 9" x 14'	105" x 168"	198"	124 1/2" x 184 1/2"	383573	6260	163	383786	B	4065	383199	1323
10' x 16'	120" x 192"	226"	136 1/2" x 208 1/2"	383574	6701	238	383786	B	4065	383200	1641
11' 3" x 18'	135" x 216"	255"	154 1/2" x 232 1/2"	383575	7524	191	383787	C	4383	383201	2262
12' 6" x 20'	150" x 240"	283"	166 1/2" x 256 1/2"	383576	8201	272	383787	C	4383	383202	2832
15' x 24'	180" x 288"	340"	196 1/2" x 304 1/2"	383577	9092	369	383788	D	5547	383203	3425
18' 9" x 30'	225" x 360"	425"	244 1/2" x 376 1/2"	383578	13365	485	--	--	--	383204	6128
25' x 40'	300" x 480"	566"	316 1/2" x 496 1/2"	383579	20072	644	--	--	--	383205	10901
<b>16:9 HDTV Format</b>											
4' 6" x 8'	54" x 96"	110"	70 1/2" x 112 1/2"	383560	\$3960	160	383785	A	\$3750	383186	\$878
5' 7 1/2" x 10'	67 1/2" x 120"	138"	88 1/2" x 136 1/2"	383561	4350	175	383785	A	3750	383187	1014
6' 9" x 12'	81" x 144"	165"	100 1/2" x 160 1/2"	383562	4623	210	383785	A	3750	383188	1100
7' 10 1/2" x 14'	94 1/2" x 168"	193"	112 1/2" x 184 1/2"	383563	5447	218	383785	A	3750	383189	1238
9' x 16'	108" x 192"	220"	124 1/2" x 208 1/2"	383564	6600	232	383786	B	4065	383190	1571
10' 1 1/2" x 18'	121 1/2" x 216"	248"	142 1/2" x 232 1/2"	383565	7220	268	383786	B	4065	383191	2267
11' 3" x 20'	135" x 240"	275"	154 1/2" x 256 1/2"	383566	8078	324	383787	C	4383	383192	2753
13' 6" x 24'	162" x 288"	330"	178 1/2" x 304 1/2"	383567	8874	347	383787	C	4383	383193	3254
16' 10 1/2" x 30'	202 1/2" x 360"	413"	220 1/2" x 376 1/2"	383568	12912	453	--	--	--	383194	5615
22' 6" x 40'	270" x 480"	551"	286 1/2" x 496 1/2"	383569	19454	594	--	--	--	383195	9996
<b>4:3 NTSC Video Format</b>											
6' x 8'	72" x 96"	120"	88 1/2" x 112 1/2"	383550	\$4137	114	383785	A	\$3750	383176	956\$
7' 6" x 10'	90" x 120"	150"	106 1/2" x 136 1/2"	383551	4776	145	383785	A	3750	383177	1074
9' x 12'	108" x 144"	180"	124 1/2" x 160 1/2"	383552	5759	157	383786	B	4065	383178	1196
10' 6" x 14'	126" x 168"	210"	142 1/2" x 184 1/2"	383553	6677	201	383786	B	4065	383179	1730
12' x 16'	144" x 192"	240"	160 1/2" x 208 1/2"	383554	7073	228	383787	C	4383	383180	1896
13' 6" x 18'	162" x 216"	270"	178 1/2" x 232 1/2"	383555	7797	244	383787	C	4383	383181	2402
15' x 20'	180" x 240"	300"	196 1/2" x 256 1/2"	383556	8556	350	383788	D	5547	383182	3081
18' x 24'	216" x 288"	360"	232 1/2" x 304 1/2"	383557	9825	393	383788	D	5547	383183	3909
22' 6" x 30'	270" x 360"	450"	286 1/2" x 376 1/2"	383558	16020	501	--	--	--	383184	8484
<b>MultiFormat</b>											
12' x 40'	144" x 480"	501"	160 1/2" x 496 1/2"	383580	\$14648	487	--	--	--	383206	\$5231
15' x 50'	180" x 600"	626"	196 1/2" x 616 1/2"	383581	18206	552	--	--	--	383207	8180
18' x 60'	216" x 720"	752"	232 1/2" x 736 1/2"	383582	22791	647	--	--	--	383208	11780

# StageScreen Components

Colors below refer to the color-coded knobs on frame sections.

Description	Black Finish	Silver Finish	Overall Size	PRICE
	Part No.	Part No.		
2' (Yellow) Frame Section	383473	383001	24" x 8"	\$222
3' (Red) Frame Section	383474	383002	36" x 8"	258
3 1/2' (Green) Frame Section	383475	383003	42" x 8"	269
4' (Blue) Frame Section	383476	383004	48" x 8"	305
5' (Orange) Frame Section	383477	383005	60" x 8"	321
6' (Purple) Frame Section	383478	383006	72" x 8"	365
Frame Corner	383479	383007	14 1/4" x 8"	222
Leg T-Section	383480	383008	14 1/4" x 20 1/2"	345
Top T-Section	383823	383825	24" x 24"	350
Bottom T-Section	383824	383826	24" x 24"	356
Frame Stiffener Bar	383481	383009	2" x 22"	42
Dual Frame Stiffener Bar	383790	383789	4" x 22"	437
Anti-Sway Stabilizers (Pair)	383805	383808	2" x 22"	429
Anti-Sway Stabilizer (Left)	383806	383809	2" x 22"	215
Anti-Sway Stabilizer (Right)	383807	383810	2" x 22"	215
Leg Attachment Clamp (black finish)	383482	383482	2" x 2"	63
Carrying Case	219200	219200	15 5/8" x 20 1/2"	678
Tarp	383483	383483	144" x 216"	44

Combinations of these pieces make up **ANY SIZE** frame and legs!

## StageScreen Accessories

Description	Part No.	PRICE
Bungee loop repair kit	383829	\$8
Pull-Tab repair kit	383831	5
Wall Mount Bracket (single)	383827	75
Fly Bracket (single)	385221	57
Fly Bracket (pair)	385222	98

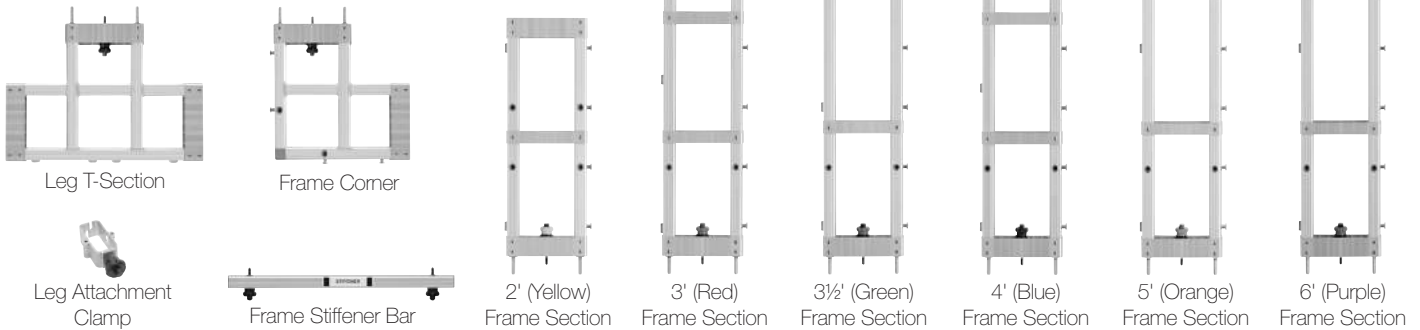

PORTABLE SCREENS

## DRAPER PRO PORTAL

### Online StageScreen Configurator

Draper's online StageScreen configurator allows you to quickly and easily see what screen sizes your inventory can build, or see what frame pieces are required to create one or a whole list of sizes.

register at: [DraperInc.com/DraperPRO](http://DraperInc.com/DraperPRO)

**Fly cages and stackers can easily mount your large venue projectors to trusses using cheeseborough clamps.**

**Check out Draper's new fly cages on page 91!**

# StageScreen® Dress Kits

A complete StageScreen Dress Kit includes a 68" tall skirt, 14" tall valance, universal valance bars, a pair of 32" wide side drapes and adjustable drapery bars. Valance and drapery bars fit snugly onto the StageScreen frame—no tools needed. The skirt attaches with a Duraloop™ bungee on each end, and convenient built-in magnetic fasteners. A wheeled heavy-duty polyethylene carrying case is included.



Inherently Flame Retardant (IFR) Velour is standard for StageScreen Dress Kits, also available in 20 oz. Velour. Draper's IFR Velour never needs retreating—it is flame retardant for the life of the fabric. More resistant to wrinkling than standard Velour, yet 15% lighter weight for easier installation and fabric management.

- **Options:** Black is standard, also available in rich navy or a variety of custom colors—details available on request. 20 oz Velour (treated for flame retardancy) also available. Masking strips are optional.

**Flame Retardancy Standards**—Draper's Inherently Flame Retardant Velour is manufactured and certified to meet these flame retardancy standards: NFPA 701, MVS-302, BIFMA-F-1-1978, SC-191-53 Class 1 California, and UFAC Class 1.

Image Area (Feet)	Image Area (Inches)	Diag.	IFR Dress Kit with Case(s)			IFR Skirt Only		Velour Dress Kit with Case(s)			Velour Skirt Only		Freight Class
			Part No.	PRICE	Ship Wt./lbs.	Part No.	PRICE	Part No.	PRICE	Ship Wt./lbs.	Part No.	PRICE	
<b>16:10 Format</b>													
5' x 8'	60" x 96"	113"	384017	\$2301	85	384041	\$575	384065	\$2247	90	384089	\$546	70
6' 3" x 10'	75" x 120"	142"	384018	2636	100	384042	704	384066	2577	105	384090	669	70
7' 6" x 12'	90" x 144"	170"	384019	2969	112	384043	831	384067	2901	115	384091	791	70
8' 9" x 14'	105" x 168"	198"	384020	3296	116	384044	872	384068	3222	120	384092	827	70
10' x 16'	120" x 192"	226"	384021	3621	120	384045	1098	384069	3542	123	384093	1044	70
11' 3" x 18'	135" x 216"	255"	384022	3819	125	384046	1187	384070	3744	124	384094	1128	70
12' 6" x 20'	150" x 240"	283"	384023	4001	130	384047	1271	384071	3927	130	384095	1208	70
15' x 24'	180" x 288"	340"	384024	4806	140	384048	1485	384072	4707	145	384096	1413	70
<b>16:9 HDTV Format</b>													
4' 6" x 8'	54" x 96"	110"	384009	\$2288	85	384033	\$575	384057	\$2229	90	384081	\$546	70
5' 7 1/2" x 10'	67 1/2" x 120"	138"	384010	2483	100	384034	704	384058	2430	105	384082	669	70
6' 9" x 12'	81" x 144"	165"	384011	2802	112	384035	831	384059	2744	115	384083	791	70
7' 10 1/2" x 14'	94 1/2" x 168"	193"	384012	3123	116	384036	872	384060	3059	120	384084	827	70
9' x 16'	108" x 192"	220"	384013	3315	118	384037	1098	384061	3254	123	384085	1044	70
10' 1 1/2" x 18'	121 1/2" x 216"	248"	384014	3788	120	384038	1187	384062	3710	124	384086	1128	70
11' 3" x 20'	135" x 240"	275"	384015	3971	130	384039	1271	384063	3896	130	384087	1208	70
13' 6" x 24'	162" x 288"	330"	384016	4760	140	384040	1485	384064	4662	145	384088	1413	70
<b>4:3 NTSC Video Format</b>													
6' x 8'	72" x 96"	120"	384001	\$2351	90	384025	\$893	384049	\$2298	90	384073	\$848	70
7' 6" x 10'	90" x 120"	150"	384002	2607	105	384026	1092	384050	2528	107	384074	1037	70
9' x 12'	108" x 144"	180"	384003	2949	115	384027	1334	384051	2871	117	384075	1265	70
10' 6" x 14'	126" x 168"	210"	384004	3210	125	384028	1418	384052	3150	128	384076	1347	70
12' x 16'	144" x 192"	240"	384005	3405	138	384029	1778	384053	3329	140	384077	1691	70
13' 6" x 18'	162" x 216"	270"	384006	3588	144	384030	1578	384054	3504	145	384078	1502	70
15' x 20'	180" x 240"	300"	384007	4073	150	384031	1952	384055	4004	150	384079	1856	70
18' x 24'	216" x 288"	360"	384008	4893	178	384032	2549	384056	4806	180	384080	2423	70

All products in above table are in freight class 70.

PORTABLE SCREENS

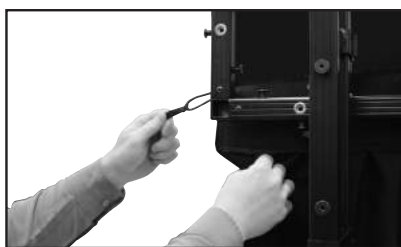

Attaching the Dress Kit Skirt to a StageScreen



Valance Bar



Two-piece Drapery Bar

## Valance Bar

Attach Valance Bars to the top of your StageScreen as needed to hang an attractive top valance. Quickly snaps onto viewing surface attachment posts and hang your valance. Black finish.

## Two-Piece Drapery Bar

Allows you to add side drapes to your StageScreen. Quickly hangs onto viewing surface attachment posts. Two piece assembly allows for easy storage. Purchase individually or in pairs. Black finish.

## StageScreen Dress Kit Accessories

Description	Part No.	PRICE
Two-Piece Drapery Bar (Pair)	384100	\$116
Two-Piece Drapery Bar (Single)	384099	59
Drapery Bar Replacement Piece (Upper Portion)	384097	33
Drapery Bar Replacement Piece (Lower Portion)	384098	35
Valance Bar	384101	53
Carrying Case	219200	678
Masking Strips for StageScreen	<b>Call for quotation</b>	

### Freight Class Key

**Number** LTL freight class  
**P** . . . . . Parcel Service  
**+** . . . . . \$15.00 surcharge (over 48" long)  
**Example:** a freight code of 125 P+ indicates an item that may ship as freight class 125 or via parcel service with \$15 surcharge.

With small profile frame sections made of sturdy extruded aluminum, the FocalPoint is extremely rigid and durable, while remaining lightweight. With no hinges, the FocalPoint is strong, and still features quick and easy assembly. All available sizes of FocalPoint are built from different length combinations of the same frame sections including the legs.

AV rental dealers can improve their ROI while streamlining inventory with the FocalPoint. You can easily build multiple screen sizes from a common inventory of frame sections, you only need to purchase separate viewing surfaces for different sizes.

**Silver Anodized Frames and components are also available. Call for a quote!**



## FocalPoint with Black-Backed Matt White XT1000VB Viewing Surface

Image Area Diagonal	Image Area (H x W)	Overall Size	Complete Screen with Matt White Surface and Black Anodized Frame		Matt White XT1000VB Surface Only		TecVision Surface Only		Complete Ship Wt./lbs.	Freight Class
			Part No.*	PRICE	Surface Part No.	PRICE	Surface Part No.	PRICE		
<b>16:10 Format</b>										
94"	50" x 80"	62" x 92"	385122	\$2529	386132	\$744	386132**	\$1578	109	85 P+
113"	60" x 96"	68" x 104"	385123	2669	386133	836	386133**	2036	149	85 P+
142"	75" x 120"	86" x 128"	385125	3369	386134	954	386134**	2829	143	85 P+
170"	90" x 144"	90" x 152"	385126	4107	386135	1166	386135**	3866	173	85
198"	105" x 168"	116" x 176"	385127	4448	386136	1302	386136**	4977	184	85
226"	120" x 192"	128" x 200"	385128	5360	386137	1733	386137**	6533	203	85
255"	135" x 216"	146" x 224"	385129	5930	386138	2010	386138**	8085	226	85
283"	150" x 240"	158" x 248"	385130	6432	386139	2384	386139**	9884	266	85
<b>16:9 HDTV Format</b>										
92"	45" x 80"	56" x 92"	385102	\$2514	386116	\$728	386116**	\$1478	108	85 P+
110"	54" x 96"	62" x 104"	385103	2618	386117	813	386117**	1893	110	85 P+
138"	67 1/2" x 120"	80" x 128"	385105	3326	386118	914	386118**	2600	160	85 P+
165"	81" x 144"	92" x 152"	385106	4172	386119	1097	386119**	3527	175	85
193"	94 1/2" x 168"	104" x 176"	385107	4374	386120	1262	386120**	4571	185	85
220"	108" x 192"	116" x 200"	385108	4944	386121	1418	386121**	5738	276	85
248"	121 1/2" x 216"	134" x 224"	385109	5825	386122	1973	386122**	7437	286	85
275"	135" x 240"	146" x 248"	385110	6306	386123	2282	386123**	9032	295	85
<b>4:3 NTSC Video Format</b>										
100"	60" x 80"	68" x 92"	385086	\$2658	386100	\$791	386100**	\$1791	120	85 P+
120"	72" x 96"	80" x 104"	385087	2799	386101	887	386101**	2327	151	85 P+
150"	90" x 120"	98" x 128"	385088	3882	386102	1011	386102**	3261	163	85
180"	108" x 144"	116" x 152"	385089	4212	386103	1200	386103**	4440	181	85
210"	126" x 168"	134" x 176"	385090	5198	386104	1539	386104**	5949	188	85
240"	144" x 192"	152" x 200"	385091	5757	386105	1818	386105**	7578	210	85
270"	162" x 216"	170" x 224"	385092	6201	386106	2172	386106**	9462	273	85
300"	180" x 240"	188" x 248"	385093	6791	386107	2595	386107**	11595	288	77.5

\*Screen part numbers include complete screen: frame, surface, legs and carrying case(s).

## FocalPoint Accessories & Components

Frame section colors below refer to the color-coded knobs.

Description	Overall Size	Silver Finish	Black Finish	PRICE
		Part No.	Part No.	
2' (Yellow) Frame Section	24" x 4"	385008	385001	\$105
3' (Red) Frame Section	36" x 4"	385009	385002	132
3 1/2' (Green) Frame Section	42" x 4"	385010	385003	171
4' (Blue) Frame Section	48" x 4"	385011	385004	186
Frame Corner	14 1/4" x 8"	385007	385005	129
Frame Corner for Large Screens	14 1/4" x 8"	385197	385196	132
Leg Package A (pair)*	—	385018	385016	1281
Leg Package B (pair)*	—	385022	385020	1947
Leg Package C (pair)*	—	385026	385024	2780
Heavy Duty Leg Brace (pr)	2" x 22"	385148	385146	150
Heavy Duty Leg Brace (single)	2" x 22"	385149	385147	75
Anti-sway Stabilizer (pr)	—	385144	385142	285
Anti-sway Stabilizer (single)	—	385145	385143	140
Crank for Leg Attachment	2 1/8"	385028	385028	14
Crank for HD Leg Brace	1 3/4"	385214	385214	14
Crank for Anti-Sway	1.31"	385215	385215	14
Leg Base "front"	4" x 12"	385014	385012	63
Tall Leg Base "front"	40" x 12"	385220	385219	140
Tall Leg Base "front" (pair)	40" x 12"	385199	385198	227
Carrying Case	—	219098	219098	359
Tarp	144" x 216"	383483	383483	44
Bungee Loop Repair Kit	—	385216	385216	6
Pull-Tab Loop Repair Kit	—	383831	383831	5
FocalPoint Fly bracket (single)	—	—	385217	54
FocalPoint Fly bracket (pair)	—	—	385218	98

\*Leg Package A (includes 8-24", 2-48", 2-T pieces) is for use with 72" high image areas or below, Leg Package B (includes 4-24", 4-36", 4-48", 2-T pieces, anti-sway and HD support) is for use with 73" to 126" image height screens, Leg Package C (includes 2-24", 6-36", 6-48", 2-T pieces, anti-sway and HD support) is for screens with 127" or larger image heights.

**Format Masking Strips are available for FocalPoint. Call for quote.**



\*\* To order a screen with a TecVision surface, the suffix codes should be added to the end of the Matt White XT1000V part number. (Ex. 386132TA for a 94" screen with the TecVision CS1000X ALR surface.) See page 6 for full descriptions and formula codes of all available TecVision surfaces.

### FocalPoint Dress Kit Accessories

Description	Part No.	PRICE
2 pc. Drape Bar (pair)	387100	\$93
2 pc. Drape Bar (single)	387099	48
Drape Bar Replacement Piece (upper portion)	384097	35
Drape Bar Replacement Piece (lower portion)	387098	36
Valance Bar (single)*	384101	53
Carrying Case	219098	354

\*Attach Valance Bars to top of FocalPoint as needed to hang an attractive top valance. Wider screens will require more.

## DRAPER PRO PORTAL

### Online FocalPoint Configurator

Draper's online FocalPoint configurator allows you to quickly and easily see what screen sizes your inventory can build, or see what frame pieces are required to create one or a whole list of sizes.

register at: [DraperInc.com/DraperPRO](http://DraperInc.com/DraperPRO)

# FocalPoint with CineFlex CH1200V Rear Viewing Surface

CineFlex White XT700V front/rear projection surface is also available at the same price as CineFlex CH1200V. See page 5 for viewing surface details. When ordering, use the CineFlex CH1200V part number followed by the appropriate suffix: **CD** for CineFlex White XT700V.

**Silver Anodized Frames and components are also available. Call for a quote!**

Image Area Diagonal	Image Area (H x W)	Overall Size	Complete Screen with CineFlex Surface and Black Anodized Frame		CineFlex CH1200V Surface Only		Complete Ship Wt./lbs.	Freight Class
			Part No.*	PRICE	Surface Part No.	PRICE		
<b>16:10 Format</b>								
94"	50" x 80"	62" x 92"	385133	\$2909	386140	\$855	109	85 P+
113"	60" x 96"	68" x 104"	385134	3069	386141	962	149	85 P+
142"	75" x 120"	86" x 128"	385136	3875	386142	1097	143	85 P+
170"	90" x 144"	98" x 152"	385137	4724	386143	1341	173	85
198"	105" x 168"	116" x 176"	385138	5115	386144	1497	184	85
226"	120" x 192"	128" x 200"	385139	6164	386145	1992	203	85
255"	135" x 216"	146" x 224"	385140	6819	386146	2312	226	85
283"	150" x 240"	158" x 248"	385141	7397	386147	2741	266	85
<b>16:9 HDTV Format</b>								
92"	45" x 80"	56" x 92"	385111	\$2891	386124	\$837	108	85 P+
110"	54" x 96"	62" x 104"	385112	3011	386125	935	110	85 P+
138"	67 1/2" x 120"	80" x 128"	385114	3825	386126	1050	160	85 P+
165"	81" x 144"	92" x 152"	385115	4797	386127	1262	175	85
193"	94 1/2" x 168"	104" x 176"	385116	5030	386128	1451	185	85
220"	108" x 192"	116" x 200"	385117	5685	386129	1631	276	85
248"	121 1/2" x 216"	134" x 224"	385118	6698	386130	2268	286	85
275"	135" x 240"	146" x 248"	385119	7253	386131	2624	295	85
<b>4:3 NTSC Video Format</b>								
100"	60" x 80"	68" x 92"	385094	\$3057	386108	\$909	120	85 P+
120"	72" x 96"	80" x 104"	385095	3219	386109	1020	168	85 P+
150"	90" x 120"	98" x 128"	385096	4464	386110	1163	176	85
180"	108" x 144"	116" x 152"	385097	4844	386111	1380	181	85
210"	126" x 168"	134" x 176"	385098	5978	386112	1770	188	85
240"	144" x 192"	152" x 200"	385099	6621	386113	2091	210	85
270"	162" x 216"	170" x 224"	385100	7131	386114	2498	273	85
300"	180" x 240"	188" x 248"	385101	7809	386115	2985	288	77.5

\*Screen part numbers include complete screen: frame, surface, legs and carrying case(s).

## FocalPoint Dress Kits—Inherently Flame Retardant (IFR) & Standard 20 oz. Velour

Image Area Diagonal	Image Area (H x W)	Overall Size	IFR Dress Kit Complete with Case(s)		IFR Skirt Only		Velour Dress Kit Complete with Case(s)		Velour Skirt Only		Complete Ship Wt./lbs.	Freight Class
			Dress Kit Part No.*	PRICE	Skirt Part No.	PRICE	Dress Kit Part No.*	PRICE	Skirt Part No.	PRICE		
<b>16:10 Format</b>												
94"	50" x 80"	62" x 92"	387017	\$2024	387041	\$525	387065	\$1883	387089	\$494	109	85 P+
113"	60" x 96"	68" x 104"	387018	2042	387042	569	387066	1895	387090	534	149	85 P+
142"	75" x 120"	86" x 128"	387019	2390	387043	659	387067	2217	387091	623	143	85 P+
170"	90" x 144"	98" x 152"	387020	2636	387044	776	387068	2454	387092	731	173	85
198"	105" x 168"	116" x 176"	387021	3000	387045	861	387069	2792	387093	818	184	85
226"	120" x 192"	128" x 200"	387022	3192	387046	1032	387070	2984	387094	972	203	85
255"	135" x 216"	146" x 224"	387023	3488	387047	1194	387071	3242	387095	1110	226	85
283"	150" x 240"	158" x 248"	387024	4115	387048	1415	387072	3824	387096	1323	266	85
<b>16:9 HDTV Format</b>												
92"	45" x 80"	56" x 92"	387009	\$2009	387033	\$525	387057	\$1866	387081	\$494	108	85 P+
110"	54" x 96"	62" x 104"	387010	2028	387034	569	387058	1881	387082	534	110	85 P+
138"	67 1/2" x 120"	80" x 128"	387011	2372	387035	659	387059	2205	387083	623	160	85 P+
165"	81" x 144"	92" x 152"	387012	2624	387036	776	387060	2439	387084	731	175	85
193"	94 1/2" x 168"	104" x 176"	387013	2967	387037	861	387061	2762	387085	818	185	85
220"	108" x 192"	116" x 200"	387014	3164	387038	1032	387062	2951	387086	972	276	85
248"	121 1/2" x 216"	134" x 224"	387015	3440	387039	1194	387063	3212	387087	1110	286	85
275"	135" x 240"	146" x 248"	387016	3648	387040	1415	387064	3489	387088	1323	295	85
<b>4:3 NTSC Video Format</b>												
100"	60" x 80"	68" x 92"	387001	\$2042	387025	\$525	387049	\$1832	387073	\$494	120	85 P+
120"	72" x 96"	80" x 104"	387002	2141	387026	569	387050	1928	387074	534	168	85 P+
150"	90" x 120"	98" x 128"	387003	2418	387027	659	387051	2253	387075	623	176	85
180"	108" x 144"	116" x 152"	387004	2700	387028	776	387052	2513	387076	731	181	85
210"	126" x 168"	134" x 176"	387005	3047	387029	861	387053	2838	387077	818	188	85
240"	144" x 192"	152" x 200"	387006	3252	387030	1026	387054	3044	387078	972	210	85
270"	162" x 216"	170" x 224"	387007	3533	387031	1185	387055	3302	387079	1110	273	85
300"	180" x 240"	188" x 248"	387008	3755	387032	1274	387056	3513	387080	1199	288	77.5

\*Dress Kit part numbers include: a 58" tall skirt, 14" tall valance, universal valance bars, a pair of 30" wide side drapes and adjustable drapery bars and needed case(s).

PORTABLE SCREENS

# Ultimate Folding Screen

The Ultimate Folding Screen is the first screen manufactured with 100% Computer Numerical Controlled (CNC) components and assembly. The tubing is CNC machined, surfaces and borders are CNC cut; even rivet and snap holes are CNC placed. No competitive product meets this standard—and we did not stop there. Our Lock & Load latch is designed for ease of operation and maximum life. Couple these advantages with clear anodized 1.25" x 0.7" wall aluminum tubing, and you've got the precision and stability that allows Draper to offer the Ultimate Folding Screen in sizes through 16' wide.

The Ultimate Folding Screen is available with Matt White XT1000V for front projection. For rear projection, choose CineFlex CH1200V or CineFlex White XT700V front/rear projection surface. For maximum flexibility, choose multiple surfaces! All surfaces—front and rear—have square corners. Borders are electronically welded using a PVC material that provides straight, clean edges. Ultimate Folding Screen standard viewing surfaces may be interchanged freely with Cinefold surfaces and have 2¾" black masking borders.

Standard Legs support the Ultimate Folding Screen in a vertical position. The screen may also be tilted for keystone elimination using the Heavy-Duty Legs which offer extra stability with an adjustable gusset (recommended for sizes larger than 7½' high). For maximum stability, Extra Heavy-Duty Legs are recommended in sizes 10 ½' high or larger. The Ultimate Folding Screen comes packed in Draper's heavy-duty, molded polyethylene wheeled carrying case.

**Note—Custom sizes are not available.**



Shown with Heavy Duty Legs



Lock & Load latch open



Lock & Load latch closed



Corner Hinge closed



Corner Hinge open

Our Lock & Load latch is designed for ease of operation and maximum life. Lock & Load mortise latches bite down when the surface is attached, making the frame extremely rigid. The most user-friendly and incredibly durable hinge locking mechanism available.

## Ultimate Folding Screen with Flexible Matt White XT1000V Front Projection Surface

Overall Size H x W	Image Area	Nom. Diag.	Complete with Standard Legs		Complete with Heavy Duty Legs		Complete with Extra Heavy Duty Legs		Surface Only		Carrying Case Part No.	Complete Shipping Wt./lbs.	Freight Class
			Part No.	PRICE	Part No.	PRICE	Part No.	PRICE	Part No.	PRICE			
<b>16:10 Format</b>													
56" x 86"	50 ½" x 80 ¾"	95"	241281	\$1113	241301	\$1382	241311	\$1476	241291	\$423	219203	61	85 P
62" x 96"	56 ½" x 90 ½"	107"	241282	1164	241302	1431	241312	1526	241292	444	219203	70	85 P
69" x 107"	63 ½" x 101 ½"	120"	241283	1301	241303	1574	241313	1667	241293	611	219203	72	85 P
83" x 130"	77 ½" x 124"	146"	241284	1481	241304	1755	241314	1848	241294	642	219203	79	85 P
97" x 152"	91 ½" x 146 ½"	173"	241323	1698	241325	1970	241327	2063	241335	957	219098	95	85 P
112" x 176"	106 ½" x 170 ½"	201"	241285	1985	241305	2253	241315	2346	241295	1022	219098	98	85 P
<b>16:9 HDTV Format</b>													
56" x 96"	50 ½" x 90 ½"	106"	241013	\$1113	241035	\$1382	241248	\$1476	241057	\$423	219203	70	85 P
62" x 108"	56 ½" x 102 ½"	119"	241014	1164	241036	1431	241249	1526	241058	444	219203	72	85 P
69" x 120"	63 ½" x 114 ½"	133"	241015	1301	241037	1574	241250	1667	241059	611	219203	75	85 P
83" x 144"	77 ½" x 138 ½"	161"	241181	1481	241182	1755	241251	1854	241183	858	219203	78	85 P
97" x 168"	91 ½" x 162 ½"	186"	241329	1698	241331	1970	241333	2063	241337	957	219098	89	85 P
112" x 196"	106 ½" x 190 ½"	220"	241016	1985	241038	2253	241252	2346	241060	1022	219098	99	85 P+
<b>16:9 HDTV - Euro Format</b>													
56" x 94"	48" x 86"	98"	381017	\$1110	381043	\$1365	381209	\$1455	381069	\$413	219203	75	85 P
67" x 113"	59" x 105"	120"	381018	1214	381044	1517	381210	1596	381070	504	219203	85	85 P
80" x 136"	72" x 128"	147"	381019	1422	381045	1647	381211	1734	381071	684	219203	92	85 P
89" x 152"	81" x 144"	165"	381284	1526	381286	1820	381288	1941	381290	891	219203	96	85 P
<b>4:3 NTSC Video Format</b>													
54" x 74"	48 ½" x 68 ½"	90"	241007	\$828	241028	\$1103	241241	\$1197	241050	\$270	219203	59	85 P
62" x 83"	56 ½" x 77 ½"	100"	241008	1053	241029	1326	241242	1421	241051	306	219203	69	85 P
6' x 8'	66 ½" x 90 ½"	10'	241009	1130	241030	1406	241243	1499	241052	423	219203	75	85 P
7' 6" x 10'	84 ½" x 114 ½"	150"	241010	1301	241031	1574	241244	1667	241053	629	219203	80	85 P
9' x 12'	102 ½" x 138 ½"	15'	241011	1481	241032	1755	241245	1848	241054	857	219203	84	85 P
10' 6" x 14'	120 ½" x 162 ½"	200"	241012	1698	241033	1970	241246	2063	241055	1119	219203	85	85 P
12' x 16'	138 ½" x 186 ½"	20'	--	--	241034	2358	241214	2453	241056	1374	219098	99	85 P+
<b>1:1 Square Format</b>													
6' x 6'	66 ½" x 66 ½"		241001	\$1071	241022	\$1353	241235	\$1451	241044	\$335	219203	60	85 P
7' x 7'	78 ½" x 78 ½"		241002	1169	241023	1451	241236	1551	241045	438	219203	63	85 P
8' x 8'	90 ½" x 90 ½"		241003	1257	241024	1539	241237	1638	241046	534	219203	71	85 P
9' x 9'	102 ½" x 102 ½"		241004	1386	241025	1668	241238	1769	241047	749	219203	72	85 P
10' x 10'	114 ½" x 114 ½"		241005	1467	241026	1748	241239	1844	241048	851	219203	75	85 P
12' x 12'	138 ½" x 138 ½"		241006	1725	241027	2007	241240	2103	241049	1061	219098	83	85 P

<sup>1</sup> Heavy-Duty Legs are recommended for frame heights greater than 7'6". All Heavy-Duty Legs are 144" tall.  
<sup>2</sup> Extra Heavy-Duty Legs are recommended for added stability on frame heights measuring 10'6" or greater.

# Ultimate Folding Screen with CineFlex CH1200V Rear Projection Surfaces

CineFlex White XT700V front/rear projection surface is also available at the same price as CineFlex CH1200V.

See page 5 for viewing surface details. When ordering these surfaces, use the CineFlex CH1200V part number followed by the appropriate suffix: **CD** for CineFlex White XT700V.

PORTABLE SCREENS

Overall Size H x W	Image Area	Nom. Diag.	Complete with Standard Legs		Complete with Heavy Duty Legs		Complete with Extra Heavy Duty Legs		Surface Only		Carrying Case Part No.	Complete Shipping Wt./lbs.	Freight Class
			Part No.	PRICE	Part No.	PRICE	Part No.	PRICE	Part No.	PRICE			
<b>16:10 Format</b>													
56" x 86"	50 1/2" x 80 3/4"	95"	241286	\$1280	241306	\$1589	241316	\$1698	241296	\$486	219203	70	85 P
62" x 96"	56 1/2" x 90 1/2"	107"	241287	1338	241307	1646	241317	1755	241297	510	219203	71	85 P
69" x 107"	63 1/2" x 101 1/2"	120"	241288	1496	241308	1809	241318	1917	241298	702	219203	72	85 P
83" x 130"	77 1/2" x 124"	146"	241289	1703	241309	2019	241319	2126	241299	738	219203	77	85 P
97" x 152"	91 1/2" x 146 1/2"	173"	241324	1953	241326	2265	241328	2372	241336	1101	219098	95	85 P
112" x 176" <sup>1</sup>	106 1/2" x 170 1/2"	201"	241290	2282	241310	2591	241320	2699	241300	1175	219098	98	85 P
<b>16:9 HDTV Format</b>													
56" x 96"	50 1/2" x 90 1/2"	106"	241078	\$1280	241100	\$1589	241271	\$1698	241122	\$486	219203	70	85 P
62" x 108"	56 1/2" x 102 1/2"	119"	241079	1338	241101	1646	241272	1755	241123	510	219203	73	85 P
69" x 120"	63 1/2" x 114 1/2"	133"	241080	1496	241102	1809	241273	1917	241124	702	219203	75	85 P
83" x 144"	77 1/2" x 138 1/2"	161"	241184	1703	241185	2019	241274	2132	241186	987	219203	83	85 P
97" x 168"	91 1/2" x 162 1/2"	186"	241330	1953	241332	2265	241334	2372	241338	1101	219098	95	85 P
112" x 196" <sup>1</sup>	106 1/2" x 190 1/2"	220"	241081	2282	241103	2591	241275	2699	241125	1175	219098	99	85 P+
<b>16:9 HDTV - Euro Format</b>													
56" x 94"	48" x 86"	98"	381095	\$1277	381121	\$1571	381235	\$1674	381147	\$474	219203	75	85 P
67" x 113"	59" x 105"	120"	381096	1395	381122	1745	381236	1836	381148	579	219203	85	85 P
80" x 136"	72" x 128"	147"	381097	1635	381123	1895	381237	1994	381149	786	219203	92	85 P
89" x 152"	81" x 144"	165"	381285	1755	381287	2093	381289	2232	381291	1025	219203	96	85 P
<b>4:3 NTSC Video Format</b>													
54" x 74"	48 1/2" x 68 1/2"	90"	241072	\$953	241093	\$1268	241264	\$1377	241115	\$311	219203	59	85 P
62" x 83"	56 1/2" x 77 1/2"	100"	241073	1211	241094	1526	241265	1634	241116	353	219203	61	85 P
6" x 8"	66 1/2" x 90 1/2"	10'	241074	1299	241095	1617	241266	1724	241117	486	219203	75	85 P
7' 6" x 10'1"	84 1/2" x 114 1/2"	150"	241075	1496	241096	1809	241267	1917	241118	723	219203	82	85 P
9' x 12'1"	102 1/2" x 138 1/2"	15'	241076	1703	241097	2019	241268	2126	241119	986	219203	83	85 P
10' 6" x 14'2"	120 1/2" x 162 1/2"	200"	241077	1953	241098	2265	241269	2372	241120	1287	219203	85	85 P
12' x 16'2"	138 1/2" x 186 1/2"	20'	--	--	241099	2712	241270	2820	241121	1580	219098	99	85 P+
<b>1:1 Square Format</b>													
6' x 6'	66 1/2" x 66 1/2"		241066	\$1232	241087	\$1556	241258	\$1668	241109	\$384	219203	60	85 P
7' x 7'	78 1/2" x 78 1/2"		241067	1344	241088	1668	241259	1784	241110	504	219203	62	85 P
8' x 8'1"	90 1/2" x 90 1/2"		241068	1446	241089	1770	241260	1884	241111	614	219203	65	85 P
9' x 9'1"	102 1/2" x 102 1/2"		241069	1595	241090	1919	241261	2034	241112	861	219203	69	85 P
10' x 10'1"	114 1/2" x 114 1/2"		241070	1688	241091	2010	241262	2120	241113	978	219203	75	85 P
12' x 12'2"	138 1/2" x 138 1/2"		241071	1985	241092	2309	241263	2418	241114	1220	219098	83	85 P

<sup>1</sup> Heavy-Duty Legs are recommended for frame heights greater than 7'6". All Heavy-Duty Legs are 144" tall.

<sup>2</sup> Extra Heavy-Duty Legs are recommended for added stability on frame heights measuring 10'6" or greater.

## Ultimate Folding Screen Accessories

Accessory	Part No.	Price
Heavy-Duty Legs, ordered separately (pr.)	382104	\$555
Extra Heavy-Duty Legs, ordered separately (pr.)	382107	648
Anti-Sway Stabilizers (pr.)	382119	179
Standard T-Legs—115" tall (pr.)	382101	369
Standard T-Legs—126" tall (pr.)	382113	369
Standard T-Legs—144" tall (pr.)	382116	369
Crank with large washer, for use only with UFS Adjustable Skirt Bar	219060	8
Handy Crank (2.25")	219004	8
Handy Crank (2.75")	219059	8
Carrying Case for Screen see page 83	219203	296
Carrying Case for Dress Kit see page 83	219203	296
Repair Kit for UFS with tools	382155	483
Repair Kit for UFS without tools	382156	276
Brace Clamp Kit for UFS	382478	155
HDTV to NTSC Masking Strips	see page 78	
Fly Bracket (single)	385221	57
Fly Bracket (pair)	385222	98

**Freight Class Key**

**Number** LTL freight class

**P** . . . . . Parcel Service

**+** . . . . . \$15.00 surcharge (over 48" long)

**Example:** a freight code of 125 P+ indicates an item that may ship as freight class 125 or via parcel service with \$15 surcharge.



# Dress Kits for Ultimate Folding Screen with standard velour

Standard fabric is 20 oz. black cotton Velour, treated for flame retardancy. A complete Dress Kit includes 46" height skirt, 12" height valance, and two 32" width side drapes. 100% CNC (Computer Numerical Controlled) valance bar and drapery bars fit snugly into the top of the Ultimate Folding Screen frame—no tools needed. The viewing surface is fitted with snaps to accept the skirt.

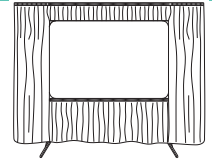

- Options:** Also available in rich navy or a variety of custom colors. Details available on request. The Adjustable Skirt Bar allows you to quickly and easily change the aspect ratio of your screen by masking the bottom of the viewing surface—indefinitely adjustable. *Replacement carrying case see page 78.*

**Note: Heavy-Duty or Extra Heavy-Duty Legs are recommended for extra stability. Weights include carrying case.**

**\*Extra Heavy-Duty Legs recommended for these screens with full dress kit.**

Overall Screen Size	Dress Kit with Case		Dress Kit without Case		Adjustable Skirt Bar		Skirt Only		Dress Kit Shipping Wt./lbs.	Freight Class
	Part No.	PRICE	Part No.	PRICE	Part No.	PRICE	Part No.	PRICE		
<b>16:10 Format</b>										
56" x 86"	242193	\$1944	242198	\$1643	242203	\$315	242208	\$437	55	70 P
62" x 96"	242194	2025	242199	1722	242204	318	242209	495	65	70 P
69" x 107"	242195	2130	242200	1826	242205	323	242210	537	73	70 P
83" x 130"	242196	2325	242201	2021	242206	345	242211	603	87	70 P
97" x 152"	242269	2438	242270	2142	242273	359	242275	662	87	70 P
112" x 176"	242197	2526	242202	2217	242207	378	242212	725	96	70 P
<b>16:9 HDTV Format</b>										
56" x 96"	242014	\$1944	242038	\$1643	242096	\$315	242073	\$437	55	70 P
62" x 108"	242015	2025	242039	1722	242097	318	242074	495	65	70 P
69" x 120"	242016	2130	242040	1826	242098	323	242075	537	73	70 P
83" x 144"	242017	2325	242041	2021	242099	345	242076	603	87	70 P
97" x 168"	242271	2438	242272	2142	242274	359	242212	725	90	70 P
112" x 196"	242018	2526	242042	2217	242118	378	242077	725	96	70 P
<b>16:9 HDTV - Euro Format</b>										
56" x 94"	382216	\$1926	382242	\$1626	382379	\$315	382268	\$434	55	70 P
67" x 113"	382217	2076	382243	1761	382380	321	382269	506	64	70 P
80" x 136"	382218	2204	382244	1902	382381	335	382270	567	71	70 P
89" x 152"	382472	2370	382473	2070	--	--	--	627	72	70 P
<b>4:3 NTSC Video Format</b>										
54" x 74"	242007	\$2138	242031	\$1830	242089	\$309	242066	\$537	49	70 P
62" x 83"	242008	1721	242032	1415	242090	312	242067	347	52	70 P
6' x 8'	242009	1865	242033	1560	242091	315	242068	411	63	70 P
7' 6" x 10'	242010	1944	242034	1643	242092	323	242069	437	68	70 P
9' x 12"	242011	2325	242035	2021	242093	345	242070	603	76	70 P
10' 6" x 14"	242012	2486	242036	2183	242094	359	242071	662	79	70 P
12' x 16"	242024	2658	242037	2354	242095	378	242072	720	98	70 P
<b>1:1 Square Format</b>										
6' x 6'	242001	\$1766	242025	\$1463	242083	\$309	242060	\$347	55	70 P
7' x 7'	242002	1923	242026	1619	242084	312	242061	411	65	70 P
8' x 8'	242003	2019	242027	1709	242085	315	242062	437	73	70 P
9' x 9"	242004	2106	242028	1803	242086	318	242063	495	76	70 P
10' x 10"	242005	2237	242029	1932	242087	323	242064	537	79	70 P
12' x 12"	242006	2451	242030	2147	242088	345	242065	603	94	70 P

PORTABLE SCREENS

Overall Screen Size	Valance Bar		Valance		Drapery Bars (pr.)		Drapes (pr.)	
	Part No.	PRICE	Part No.	PRICE	Part No.	PRICE	Part No.	PRICE
<b>16:10 Format</b>								
56" x 86"	242213	\$240	220305	\$243	382112	\$246	220310	\$467
62" x 96"	242214	245	220306	251	382112	246	220311	473
69" x 107"	242215	248	220307	275	382112	246	220312	506
83" x 130"	242216	272	220308	294	382112	246	220313	593
97" x 152"	242279	275	220325	318	382112	246	220329	669
112" x 176"	242217	284	220309	345	382112	246	220314	714
<b>16:9 HDTV Format</b>								
56" x 96"	242106	\$240	220177	\$243	382112	\$246	220185	\$467
62" x 108"	242107	245	220178	251	382112	246	220186	473
69" x 120"	242108	248	220179	275	382112	246	220187	506
83" x 144"	242109	272	220180	294	382112	246	220188	593
97" x 168"	242280	275	220327	318	382112	246	220331	669
112" x 196"	242110	284	220191	345	382112	246	220195	714
<b>4:3 NTSC Video Format</b>								
54" x 74"	242103	\$179	220189	\$210	382112	\$246	220193	\$419
62" x 83"	242104	230	220072	227	382112	246	220152	431
6' x 8'	242051	240	220073	243	382112	246	220153	467
7' 6" x 10'	242052	248	220074	275	382112	246	220154	512
9' x 12"	242053	272	220075	294	382112	246	220155	593
10' 6" x 14"	242105	275	220076	318	382112	246	220156	669
12' x 16"	242054	284	220190	338	382112	246	220194	749
<b>1:1 Square Format</b>								
6' x 6'	242057	\$179	220066	\$210	382112	\$246	220098	\$467
7' x 7'	242058	230	220067	227	382112	246	220099	491
8' x 8'	242059	240	220068	243	382112	246	220100	536
9' x 9"	242100	245	220069	251	382112	246	220101	555
10' x 10'	242101	248	220070	275	382112	246	220102	611
12' x 12'	242102	272	220071	294	382112	246	220103	719

# Dress Kits for Ultimate Folding Screen with IFR velour

Draper's Inherently Flame Retardant (IFR) Velour never needs retreating—it is flame retardant for the life of the fabric. More resistant to wrinkling than standard velour, yet 15% lighter weight for easier installation and fabric management.

**Flame Retardancy Standards**—Draper's Inherently Flame Retardant Velour is manufactured and certified to meet these flame retardancy standards: NFPA 701, MVS-302, BIFMA-F-1-1978, SC-191-53 Class 1 California, and UFAC Class 1.

A complete Dress Kit includes 46" height skirt, 12" height valance, and two 32" width side drapes, all in IFR Velour. The viewing surface is fitted with snaps to accept the skirt.

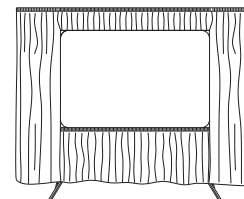

• **Options:** The Adjustable Skirt Bar allows you to quickly and easily change the aspect ratio of your screen by masking the bottom of the viewing surface—indefinitely adjustable. Replacement carrying case—see page 78.

Overall Screen Size	Dress Kit with Case		Dress Kit without Case		Adjustable Skirt Bar		Skirt Only		Dress Kit Shipping Wt./lbs.	Freight Class
	Part No.	PRICE	Part No.	PRICE	Part No.	PRICE	Part No.	PRICE		
<b>16:10 Format</b>										
56" x 86"	242218	\$2049	242223	\$1757	242203	\$315	242233	\$480	55	70 P
62" x 96"	242219	2139	242224	1847	242204	318	242234	548	65	70 P
69" x 107"	242220	2270	242225	1980	242205	323	242235	606	73	70 P
83" x 130"	242221	2474	242226	2183	242206	345	242236	674	87	70 P
97" x 152"	242244	2592	242245	2210	242273	359	242276	705	87	70 P
112" x 176"	242222	2720	242227	2430	242207	378	242237	818	96	70 P
<b>16:9 HDTV Format</b>										
56" x 96"	242136	\$2049	242160	\$1757	242096	\$315	242183	\$480	55	70 P
62" x 108"	242137	2139	242161	1847	242097	318	242184	548	65	70 P
69" x 120"	242138	2270	242162	1980	242098	323	242185	606	73	70 P
83" x 144"	242139	2474	242163	2183	242099	345	242186	674	87	70 P
97" x 168"	242246	2592	242247	2210	242274	359	242278	705	87	70 P
112" x 196"	242140	2720	242164	2430	242118	378	242187	818	96	70 P
<b>16:9 HDTV - Euro Format</b>										
56" x 94"	382405	\$2037	382431	\$1754	382379	\$315	382457	468	55	70 P
67" x 113"	382406	2193	382432	1920	382380	321	382458	575	64	70 P
80" x 136"	382407	2361	382433	2070	382381	335	382459	638	71	70 P
<b>4:3 NTSC Video Format</b>										
54" x 74"	242130	\$2289	242153	\$2391	242089	\$309	242176	\$606	49	70 P
62" x 83"	242131	2679	242154	1997	242090	312	242177	743	52	70 P
6' x 8'	242132	1790	242155	1505	242091	315	242178	377	59	70 P
7' 6" x 10'	242133	1964	242156	1673	242092	323	242179	452	62	70 P
9' x 12"	242134	2060	242157	1773	242093	345	242180	480	68	70 P
10' 6" x 14"	242135	2496	242158	2207	242094	359	242181	674	75	70 P
12' x 16"	242146	2870	242159	2583	242095	378	242182	809	98	70 P
<b>1:1 Square Format</b>										
6' x 6'	242124	\$1854	242147	\$1563	242083	\$309	242170	\$377	55	70 P
7' x 7'	242125	2034	242148	1745	242084	312	242171	452	65	70 P
8' x 8'	242126	2147	242149	1857	242085	315	242172	480	76	70 P
9' x 9'	242127	2261	242150	1976	242086	318	242173	548	76	70 P
10' x 10"	242128	2412	242151	2121	242087	323	242174	606	79	70 P
12' x 12"	242129	2643	242152	2355	242088	345	242175	674	94	70 P

Note: Heavy-Duty or Extra Heavy-Duty Legs are recommended for extra stability. Weights include carrying case.

\*Extra Heavy-Duty Legs recommended for these screens with full dress kit.

Overall Screen Size	Valance Bar		Valance		Drapery Bars (pr.)		Drapes (pr.)	
	Part No.	PRICE	Part No.	PRICE	Part No.	PRICE	Part No.	PRICE
<b>16:10 Format</b>								
56" x 86"	242213	\$240	220315	\$260	382112	\$246	220320	\$537
62" x 96"	242214	245	220316	276	382112	246	220321	543
69" x 107"	242215	248	220317	300	382112	246	220322	591
83" x 130"	242216	272	220318	324	382112	246	220323	678
97" x 152"	242279	275	220326	335	382112	246	220330	752
112" x 176"	242217	284	220319	380	382112	246	220324	785
<b>16:9 HDTV Format</b>								
56" x 96"	242106	\$240	220288	\$260	382112	\$246	220292	\$537
62" x 108"	242107	245	220289	276	382112	246	220293	543
69" x 120"	242108	248	220290	300	382112	246	220294	591
83" x 144"	242109	272	220291	324	382112	246	220295	678
97" x 168"	242280	275	220328	335	382112	246	220332	752
112" x 196"	242110	284	220298	380	382112	246	220302	785
<b>4:3 NTSC Video Format</b>								
54" x 74"	242103	\$179	220296	\$218	382112	\$246	220300	\$492
62" x 83"	242104	230	220236	243	382112	246	220272	513
6' x 8'	242051	240	220237	260	382112	246	220273	557
7' 6" x 10'	242052	248	220238	300	382112	246	220274	608
9' x 12"	242053	272	220239	324	382112	246	220275	699
10' 6" x 14'	242105	275	220240	354	382112	246	220276	789
12' x 16"	242054	284	220297	377	382112	246	220301	879
<b>1:1 Square Format</b>								
6' x 6'	242057	\$179	220230	\$218	382112	\$246	220246	\$557
7' x 7'	242058	230	220231	243	382112	246	220247	588
8' x 8'	242059	240	220232	260	382112	246	220248	639
9' x 9'	242100	245	220233	276	382112	246	220249	671
10' x 10'	242101	248	220234	300	382112	246	220250	734
12' x 12'	242102	272	220235	324	382112	246	220251	851

PORTABLE SCREENS

Portable folding screen complete with carrying case. Available with interchangeable front and rear projection surfaces. Rotational molded polyethylene case comes complete with wheels. Standard viewing surfaces can be interchanged freely with Ultimate Folding Screen surfaces.

Complete unit includes frame, legs and snap-on surface with protective soft pouch in one polyethylene carrying case. Shipping weights are based on one standard complete Cinefold. Addition of a replacement surface or other options may increase the weight. Heavy-Duty Legs and anti-sway stabilizers are recommended for any Cinefold when used with a dress kit. **Multi-image and custom sizes available: call for quotation.**

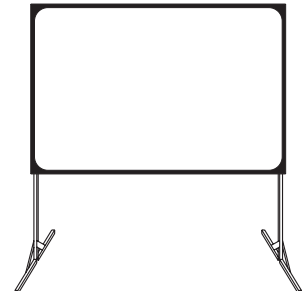

## Cinefold with Flexible Matt White XT1000V Front Projection Surface

Overall Size	Image Area	Nom. Diag.	Complete with Standard Legs		Complete with HD Legs		Surface Only		Carrying Case Part No.	Ship Wt./lbs. Complete	Dim Wt./lbs. Complete	Freight Class
			Part No.	PRICE	Part No.	PRICE	Part No.	PRICE				
<b>16:9 HDTV Format</b>												
56" x 96"	50 1/2" x 90 1/2"	106"	218177	\$1073	218193	\$1337	218181	\$402	219203	50	66	85 P
62" x 108"	56 1/2" x 102 1/2"	119"	218178	1122	218194	1385	218182	422	219203	52	66	85 P
69" x 120"	63 1/2" x 114 1/2"	133"	218179	1257	218195	1518	218183	578	219203	73	98	85 P
83" x 144"	77 1/2" x 138 1/2"	161"	218180	1430	218196	1695	218184	815	219203	65	66	85 P
<b>4:3 NTSC Video Format</b>												
47" x 60"	41 1/2" x 54 1/2"	72"	218008	\$779	218084	\$1043	218027	\$252	219203	50	66	85 P
54" x 74"	48 1/2" x 68 1/2"	90"	218009	804	218085	1065	218028	258	219203	52	66	85 P
62" x 83"	56 1/2" x 77 1/2"	100"	218010	1016	218086	1280	218029	290	219203	56	66	85 P
6' x 8'	66 1/2" x 90 1/2"	10'	218011	1097	218087	1356	218030	402	219203	54	66	85 P
7' 6" x 10'	84 1/2" x 114 1/2"	150"	218012	1257	218088	1518	218031	593	219203	68		85 P
9' x 12' <sup>1</sup>	102 1/2" x 138 1/2"	15'	218013	1430	218089	1695	218032	813	219203	75		85 P
10' 6" x 14' <sup>2</sup>	120 1/2" x 162 1/2"	200"	218014	1640	218090	1904	218033	1061	219203	85	103	85 P
<b>1:1 Square Format</b>												
6' x 6'	66 1/2" x 66 1/2"		218002	\$1035	218078	\$1311	218021	\$318	219203	50	66	85 P
7' x 7'	78 1/2" x 78 1/2"		218003	1130	218079	1404	218022	417	219203	65	66	85 P
8' x 8'	90 1/2" x 90 1/2"		218004	1214	218080	1487	218023	507	219098	77		85 P+
9' x 9' <sup>1</sup>	102 1/2" x 102 1/2"		218005	1337	218081	1614	218024	707	219203	75		85 P
10' x 10' <sup>1</sup>	114 1/2" x 114 1/2"		218006	1416	218082	1692	218025	807	219203	80		85 P
12' x 12' <sup>2</sup>	138 1/2" x 138 1/2"		218007	1664	218083	1940	218026	1007	219098	90		85 P+

<sup>1</sup> Heavy-Duty Legs recommended.

<sup>2</sup> Heavy-Duty Legs recommended, and anti-sway stabilizers recommended but not included in any price above. See Accessories for prices.

## Cinefold with CineFlex CH1200V Rear Projection Surface

CineFlex White XT700V front/rear projection surface is also available at the same price as CineFlex CH1200V. See page 4 for viewing surface details. When ordering these surfaces, use the CineFlex CH1200V part number followed by the appropriate suffix: **CD** for CineFlex White XT700V.

Overall Size	Image Area	Nom. Diag.	Complete with Standard Legs		Complete with HD Legs		Surface Only		Carrying Case Part No.	Ship Wt./lbs. Complete	Dim Wt./lbs. Complete	Freight Class
			Part No.	PRICE	Part No.	PRICE	Part No.	PRICE				
<b>16:9 HDTV Format</b>												
56" x 96"	50 1/2" x 90 1/2"	106"	218185	\$1233	218197	\$1538	218189	\$462	219203	50	66	85 P
62" x 108"	56 1/2" x 102 1/2"	119"	218186	1290	218198	1592	218190	485	219203	52	66	85 P
69" x 120"	63 1/2" x 114 1/2"	133"	218187	1446	218199	1746	218191	665	219203	73	98	85 P
83" x 144"	77 1/2" x 138 1/2"	161"	218188	1644	218200	1950	218192	936	219203	65	66	85 P
<b>4:3 NTSC Video Format</b>												
47" x 60"	41 1/2" x 54 1/2"	72"	218046	\$896	218103	\$1199	218065	\$290	219203	50	66	85 P
54" x 74"	48 1/2" x 68 1/2"	90"	218047	924	218104	1226	218066	297	219203	52	66	85 P
62" x 83"	56 1/2" x 77 1/2"	100"	218048	1169	218105	1472	218067	333	219203	56	66	85 P
6' x 8'	66 1/2" x 90 1/2"	10'	218049	1262	218106	1560	218068	462	219203	54	66	85 P
7' 6" x 10'	84 1/2" x 114 1/2"	150"	218050	1446	218107	1746	218069	681	219203	68		85 P
9' x 12' <sup>1</sup>	102 1/2" x 138 1/2"	15'	218051	1644	218108	1950	218070	935	219203	75		85 P
10' 6" x 14' <sup>2</sup>	120 1/2" x 162 1/2"	200"	218052	1886	218109	2189	218071	1220	219203	85	103	85 P
<b>1:1 Square Format</b>												
6' x 6'	66 1/2" x 66 1/2"		218040	\$1191	218097	\$1508	218059	\$366	219203	50	66	85 P
7' x 7'	78 1/2" x 78 1/2"		218041	1299	218098	1614	218060	480	219203	65	66	85 P
8' x 8'	90 1/2" x 90 1/2"		218042	1395	218099	1710	218061	584	219098	77		85 P+
9' x 9' <sup>1</sup>	102 1/2" x 102 1/2"		218043	1538	218100	1856	218062	813	219203	75		85 P
10' x 10' <sup>1</sup>	114 1/2" x 114 1/2"		218044	1629	218101	1946	218063	929	219203	80		85 P
12' x 12' <sup>2</sup>	138 1/2" x 138 1/2"		218045	1913	218102	2231	218064	1158	219098	90		85 P+

<sup>1</sup> Heavy-Duty Legs recommended.

<sup>2</sup> Heavy-Duty Legs recommended, and anti-sway stabilizers recommended but not included in any price above. See Accessories for prices.

# Dress Kits for Cinefold with **standard velour**

Black 20 oz. cotton Velour is standard, treated for flame retardancy. A complete Cinefold Dress Kit includes 46" height skirt, valance, valance bar, 2 drapes and 2 drapery bars.

- **Options:** Blue 20 oz. Velour available at no additional charge. Other colors available by quotation. Heavy-Duty Legs and anti-sway stabilizers recommended but not included in prices below.

See Cinefold Accessories on page 77 for price. Wheeled polyethelene carrying case—see page 78.

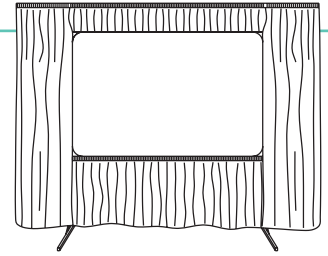

PORTABLE SCREENS

Overall Size	Dress Kit with Case		Dress Kit without Case		Optional Adjustable Skirt Bar		Skirt Only		Ship Wt./lbs. Complete	Dim Wt./lbs. Complete	Freight Class	*Weight Includes Carrying Case.
	Part No.	PRICE	Part No.	PRICE	Part No.	PRICE	Part No.	PRICE				
<b>16:9 HDTV Format</b>												
56" x 96"	220157	\$1910	220161	\$1610	220165	\$311	220169	\$429	55		70 P	
62" x 108"	220158	1985	220162	1689	220166	314	220170	480	65		70 P	
69" x 120"	220159	2088	220163	1787	220167	317	220171	527	73		70 P	
83" x 144"	220160	2277	220164	1980	220168	338	220172	591	77	87	70 P	
<b>4:3 NTSC Video Format</b>												
62" x 83"	220120	\$1827	220008	\$1530	220024	\$308	220040	\$405	48	52	70 P	
6' x 8'	220121	1910	220009	1610	220025	311	220041	429	59		70 P	
7' 6" x 10'	220122	2093	220010	1793	220026	317	220042	527	62		70 P	
9' x 12'	220123	2277	220011	1980	220027	338	220043	591	68		70 P	
10' 6" x 14'	220124	2438	220012	2139	220028	351	220044	648	75		70 P	
<b>1:1 Square Format</b>												
6' x 6'	220114	\$1731	220002	\$1437	220018	\$300	220034	\$339	55		70 P	
7' x 7'	220115	1889	220003	1586	220019	308	220035	405	65		70 P	
8' x 8'	220116	1979	220004	1680	220020	311	220036	429	73		70 P	
9' x 9'	220117	2066	220005	1769	220021	314	220037	480	76		70 P	
10' x 10'	220118	2195	220006	1895	220022	317	220038	527	79		70 P	
12' x 12'	220119	2402	220007	2105	220023	338	220039	591	94		70 P	

Overall Size	Valance Bar		Valance		Drapery Bars (pr.)		Drapes (pr.)		Carrying Case Part No.
	Part No.	PRICE	Part No.	PRICE	Part No.	PRICE	Part No.	PRICE	
<b>16:9 HDTV Format</b>									
56" x 96"	220173	\$216	220177	\$243	220181	\$224	220185	\$467	219203
62" x 108"	220174	218	220178	251	220182	224	220186	473	219203
69" x 120"	220175	219	220179	275	220183	224	220187	506	219203
83" x 144"	220176	242	220180	294	220184	224	220188	593	219098
<b>4:3 NTSC Video Format</b>									
62" x 83"	220056	\$210	220072	\$227	220147	\$224	220152	\$431	219203
6' x 8'	220057	216	220073	243	220148	224	220153	467	219203
7' 6" x 10'	220058	219	220074	275	220149	224	220154	512	219203
9' x 12'	220059	242	220075	294	220150	224	220155	593	219098
10' 6" x 14'	220060	245	220076	318	220151	224	220156	669	219098
<b>1:1 Square Format</b>									
6' x 6'	220050	\$162	220066	\$210	220082	\$224	220098	\$467	219203
7' x 7'	220051	210	220067	227	220083	224	220099	491	219203
8' x 8'	220052	216	220068	243	220084	224	220100	536	219098
9' x 9'	220053	218	220069	251	220085	224	220101	555	219098
10' x 10'	220054	219	220070	275	220086	224	220102	611	219098
12' x 12'	220055	242	220071	294	220087	224	220103	719	219098

### Freight Class Key

**Number** LTL freight class  
**P** . . . . . Parcel Service  
**+** . . . . . \$15.00 surcharge (over 48" long)

**Example:** a freight code of 125 P+ indicates an item that may ship as freight class 125 or via parcel service with \$15 surcharge.

Draper's Inherently Flame Retardant Velour never needs retreating. It is flame retardant for the life of the fabric (see page 74 for details). More resistant to wrinkling than standard Velour, yet 15% lighter weight for easier installation and transportation. A complete Cinefold Dress Kit includes skirt, valance, valance bar, 2 drapes, 2 drapery bars and 1 molded polypropylene case with wheels.

- Options: Black is standard. Other colors available by quotation. Heavy-Duty Legs and anti-sway stabilizers recommended but not included in prices below. See Cinefold Accessories below for price. *Wheeled polyethelene carrying case*—see page 78.

Overall Size	Dress Kit with Case		Dress Kit without Case		Optional Adjustable Skirt Bar		Skirt Only		Ship Wt./lbs. Complete	Dim Wt./lbs. Complete	Freight Class
	Part No.	PRICE	Part No.	PRICE	Part No.	PRICE	Part No.	PRICE			
<b>16:9 HDTV Format</b>											
56" x 96"	220304	\$2007	220280	\$1722	220165	\$311	220284	\$473	55		70 P
62" x 108"	220277	2096	220281	1812	220166	314	220285	536	58	65	70 P
69" x 120"	220278	2225	220282	1940	220167	317	220286	594	59	73	70 P
83" x 144"	220279	2426	220283	2141	220168	338	220287	660	62	87	70 P
<b>4:3 NTSC Video Format</b>											
62" x 83"	220263	\$1923	220204	\$1640	220024	\$308	220220	\$444	48		70 P
6' x 8'	220264	2021	220205	1736	220025	311	220221	473	59		70 P
7' 6" x 10'	220265	2241	220206	1955	220026	317	220222	660	62		70 P
9' x 12'	220266	2448	220207	2163	220027	338	220223	674	68		70 P
10' 6" x 14'	220267	2624	220208	2342	220028	351	220224	725	75		70 P
<b>1:1 Square Format</b>											
6' x 6'	220257	\$1818	220198	\$1535	220018	\$300	220214	\$368	55		70 P
7' x 7'	220258	1997	220199	1709	220019	308	220215	444	65		70 P
8' x 8'	220259	2105	220200	1821	220020	311	220216	473	73		70 P
9' x 9'	220260	2217	220201	1932	220021	314	220217	536	76		70 P
10' x 10'	220261	2364	220202	2079	220022	317	220218	594	79		70 P
12' x 12'	220262	2591	220203	2307	220023	338	220219	660	94		70 P

Overall Size	Valance Bar		Valance		Drapery Bars (pr.)		Drapes (pr.)		Carrying Case Part No.
	Part No.	PRICE	Part No.	PRICE	Part No.	PRICE	Part No.	PRICE	
<b>16:9 HDTV Format</b>									
56" x 96"	220173	\$216	220288	\$260	220181	\$224	220292	\$537	219203
62" x 108"	220174	218	220289	263	220182	224	220293	543	219203
69" x 120"	220175	219	220290	300	220183	224	220294	591	219203
83" x 144"	220176	242	220291	324	220184	224	220295	678	219098
<b>4:3 NTSC Video Format</b>									
62" x 83"	220056	\$210	220236	\$243	220147	\$224	220272	\$513	219203
6' x 8'	220057	216	220237	260	220148	224	220273	557	219203
7' 6" x 10'	220058	219	220238	287	220149	224	220274	608	219203
9' x 12'	220059	242	220239	324	220150	224	220275	699	219098
10' 6" x 14'	220060	245	220240	354	220151	224	220276	789	219098
<b>1:1 Square Format</b>									
6' x 6'	220050	\$162	220230	\$218	220082	\$224	220246	\$557	219203
7' x 7'	220051	210	220231	243	220083	224	220247	588	219203
8' x 8'	220052	216	220232	260	220084	224	220248	639	219098
9' x 9'	220053	218	220233	276	220085	224	220249	671	219098
10' x 10'	220054	219	220234	300	220086	224	220250	734	219098
12' x 12'	220055	242	220235	309	220087	224	220251	851	219098

## Truss & Cinefold Accessories

Accessory	Part No.	Price
Heavy-Duty Legs—7 1/2' tall, ordered separately (pr.)	219006	\$521
Heavy-Duty Legs—9' tall, ordered separately (pr.)	219007	521
Heavy-Duty Legs—12' tall, ordered separately (pr.)	219008	521
Standard T-Legs—7 1/2' tall (pr.)	219009	363
Standard T-Legs—9' tall (pr.)	219010	363
Standard T-Legs—12' tall (pr.)	219011	363
Anti-Sway Stabilizers for Cinefold (pr.) —Heavy Duty Legs required.	219001	176
Anti-Sway Stabilizers for Truss Cinefold (pr.)	219044	176
Stiffener bar for Truss Cinefold	219053	60
Screen Connection Strip (white or black)		120
Screen Connection Clamps (pr.)	219002	23
Hinge Clamps (pr.)	219003	63
Truss Cinefold Feet (pr.)	219047	333
Truss Cinefold foot Stage Left	219048	176
Truss Cinefold foot Stage Right	219049	176

Accessory	Part No.	Price
Standard crank used for all UFS, Cinefold and Truss Cinefold screens except as noted below	219004	\$8
Short crank for use only with L-Section at top of Truss Cinefold	219058	8
Repair Kit for Cinefold with tools	219005	579
Repair Kit for Cinefold without tools	219057	285
Carrying Case for screen	see page 78	
Carrying Case for Dress Kit	see page 78	
Fly Bracket (single)	385223	54
Fly Bracket (pair)	385224	101

# Portable Folding Screen and Dress Kit Cases

Designed for service and dependability. Each case has two wheels. Handles are molded into each end of case. Lid handle is steel with rubber grip, recessed in inset. Lid is secured with two adjustable straps. Stacks with lids on or nests compactly with lids off.

Draper has redesigned our portable screen cases for Portables Stronger and more stackable than ever, these cases hold larger sizes and are even easier to use. They also feature more internal space and a dramatically reinforced shell.

## Cases for Complete Screens

Part Number	Case Dimensions	Case Ship Wt./lbs.	Accommodates the following sizes:			PRICE	Replacement Case Strap	PRICE
			Square	NTSC	HDTV			
219203	12" x 15 <sup>3</sup> / <sub>4</sub> " x 52"	29	All Cinefold and UFS sizes use case 219203 except the sizes below which use 219098			\$296	219102	\$13
219098	16 <sup>3</sup> / <sub>8</sub> " x 17 <sup>1</sup> / <sub>4</sub> " x 60"	37	8' x 8' 12' x 12'	12' x 16'	112" x 196"	354	219102	13
			Used for all FocalPoint sizes					
219200	15 <sup>5</sup> / <sub>8</sub> " x 20 <sup>1</sup> / <sub>2</sub> " x 84"	51	Standard for all StageScreen and Truss Cinefold sizes			678	219103	13

## Cases for Complete Dress Kits

Part Number	Case Dimensions	Case Ship Wt./lbs.	Accommodates the following sizes:			PRICE	Replacement Case Strap	PRICE
			Square	NTSC	HDTV			
219203	12" x 15 <sup>3</sup> / <sub>4</sub> " x 52"	29	All Cinefold and UFS sizes use case 219203 except the sizes below which use 219098			\$296	219102	\$13
219098	16 <sup>3</sup> / <sub>8</sub> " x 17 <sup>1</sup> / <sub>4</sub> " x 60"	37	8' x 8' 9' x 9' 10' x 10' 12' x 12'	9' x 12' 10'6" x 14' 12' x 16'	112" x 196"	354	219102	13
			Also used for all FocalPoint sizes					
219200	15 <sup>5</sup> / <sub>8</sub> " x 20 <sup>1</sup> / <sub>2</sub> " x 84"	51	Standard for all StageScreen and Truss Cinefold sizes			678	219103	13

**Please Note—Case(s) are provided with each Ultimate Folding Screen and Cinefold portable projection screen. Case(s) are optionally available for the Ultimate Folding Screen or Cinefold Dress Kits.**

## Screen Format Masking Strips

Quickly and easily convert your HDTV folding screen to NTSC format with these black masking strips. Available in black Velour. Also available for StageScreen or 16:10 Formats—call for quotation.

HDTV Screen Size <i>without</i> Masking		NTSC Screen Size <i>with</i> Masking		Part No.	Price (Pair)	Shipping Wt./Lbs.	Freight Class
Nominal Diagonal	Image Area HxW	Nominal Diagonal	Image Area HxW				
<b>Truss Cinefold/Cineperm Masking—16:9 HDTV to 4:3 NTSC Video</b>							
220"	108" x 192"	180"	108" x 144"	219094	\$443	13	70 P
250"	120" x 218"	200"	120" x 160"	219095	474	16	70 P
275"	135" x 240"	225"	135" x 180"	219096	527	17	70 P
330"	162" x 288"	270"	162" x 216"	219097	593	19	70 P
<b>Cinefold Masking—16:9 HDTV to 4:3 NTSC Video</b>							
106"	52" x 92"	90"	52" x 70"	219090	\$176	7	70 P
119"	58" x 104"	100"	58" x 79"	219091	213	8	70 P
133"	65" x 116"	109"	65" x 87"	219092	225	9	70 P
161"	79" x 140"	133"	79" x 106"	219093	243	11	70 P
<b>UFS Masking—16:9 HDTV to 4:3 NTSC Video</b>							
106"	50 <sup>1</sup> / <sub>2</sub> " x 90 <sup>1</sup> / <sub>2</sub> "	84"	50 <sup>1</sup> / <sub>2</sub> " x 67 <sup>1</sup> / <sub>2</sub> "	219085	\$176	7	70 P
119"	56 <sup>1</sup> / <sub>2</sub> " x 102 <sup>1</sup> / <sub>2</sub> "	95"	56 <sup>1</sup> / <sub>2</sub> " x 75 <sup>1</sup> / <sub>2</sub> "	219086	213	8	70 P
133"	63 <sup>1</sup> / <sub>2</sub> " x 114 <sup>1</sup> / <sub>2</sub> "	105"	63 <sup>1</sup> / <sub>2</sub> " x 84 <sup>1</sup> / <sub>2</sub> "	219087	225	9	70 P
161"	77 <sup>1</sup> / <sub>2</sub> " x 138 <sup>1</sup> / <sub>2</sub> "	103"	77 <sup>1</sup> / <sub>2</sub> " x 103 <sup>1</sup> / <sub>2</sub> "	219088	243	11	70 P
186"	91 <sup>1</sup> / <sub>2</sub> " x 162 <sup>1</sup> / <sub>2</sub> "	151"	91 <sup>1</sup> / <sub>2</sub> " x 121"	219202	308	12	70 P
220"	106 <sup>1</sup> / <sub>2</sub> " x 190 <sup>1</sup> / <sub>2</sub> "	178"	106 <sup>1</sup> / <sub>2</sub> " x 142"	219089	398	13	70 P



**Freight Class Key**

**Number** LTL freight class  
**P** . . . . . Parcel Service  
**+** . . . . . \$15.00 surcharge (over 48" long)

**Example:** a freight code of 125 P+ indicates an item that may ship as freight class 125 or via parcel service with \$15 surcharge.

PORTABLE SCREENS

# Truss-Style Cinefold

Complete unit includes truss frame, truss legs, snap-on surface with soft case, Heavy-Duty Legs, anti-sway stabilizers, frame stiffeners for all horizontal hinges and heavy-duty carrying case. Case dimensions are 15 5/8" x 20 1/2" x 84 1/4". Shipping weight and number of cases are based on one complete truss-style Cinefold. Frame finish is scratch-resistant silver. Screens with additional viewing surfaces, hardware and draperies will be heavier and may require additional cases.

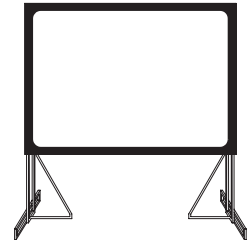

- Options: Replacement heavy-duty carrying case: **Part No. 219200. Price \$710.** Multi-image and custom sizes available—call for quotation. CineFlex White XT700V front/rear projection surface is also available at the same price as CineFlex CH1200V. See page 5 for viewing surface details. When ordering these surfaces, use the CineFlex CH1200V part number followed by the appropriate suffix: **CD** for CineFlex White XT700V.

Overall Size	Viewing Area	Flexible Matt White XT1000V Front Screen		CineFlex CH1200V Rear Screen		Ship Wt./lbs.	Freight Class	No. of Cases				
		Complete Unit Part No.	Surface Only PRICE	Complete Unit Part No.	Surface Only PRICE							
<b>16:9 HDTV Format</b>												
10' x 17'	9' x 16'	221049	\$5042	221053	\$1406	221057	\$5798	221061	\$1617	220	85	2
11' x 19'	10' x 18'	221050	5420	221054	1745	221058	6233	221062	2006	240	85	2
12' 3" x 21'	11' 3" x 20'	221051	6917	221055	2145	221059	7955	221063	2468	293	85	2
14' 6" x 25'	13' 6" x 24'	221052	7998	221056	3012	221060	9198	221064	3464	398	85	2
<b>4:3 NTSC Video Format</b>												
7' x 9'	6' x 8'	221005	\$2619	221016	\$669	221027	\$3012	221038	\$770	143	85 P+	2
8' 6" x 11'	7' 6" x 10'	221006	3836	221017	861	221028	4412	221039	990	152	85	2
10' x 13'	9' x 12'	221007	4451	221018	1094	221029	5118	221040	1257	276	85	2
11' 6" x 15'	10' 6" x 14'	221008	4944	221019	1424	221030	5685	221041	1637	286	85	2
13' x 17'	12' x 16'	221009	5940	221020	1839	221031	6831	221042	2115	312	85	2
16' x 21'	15' x 20'	221010	7416	221021	2793	221032	8529	221043	3212	340	85	2
19' x 25'	18' x 24'	221011	11574	221022	3932	221033	13310	221044	4521	371	85	2

Please Note—Case(s) provided with each Truss Style Cinefold portable projection screen and each Truss Style Dress Kit.

## Truss-Style Dress Kits with standard Velour

Black 20 oz. cotton Velour is standard, treated for flame retardancy. Complete Truss Dress Kit includes skirt, valance, valance bar, 2 drapes, 2 drapery bars and wheeled heavy-duty carrying case. Case dimensions are 15 5/8" x 20 1/2" x 84 1/4".

- Options: Blue 20 oz. Velour available at prices listed below. Other colors, custom and multi-image sizes by quotation.

Overall Size	Image Area	Complete Dress Kit		Optional Adjustable Skirt Bar		Skirt Only		Complete Dress Kit Shipping Wt./lbs.	Freight Class
		Part No.	PRICE	Part No.	PRICE	Part No.	PRICE		
<b>16:9 HDTV Format</b>									
10' x 17'	9' x 16'	222045	\$2637	222049	\$545	222053	\$749	220	85
11' x 19'	10' x 18'	222046	3072	222050	567	222054	842	240	85
12' 3" x 21'	11' 3" x 20'	222047	3777	222051	636	222055	932	293	85
14' 6" x 25'	13' 6" x 24'	222048	4001	222052	659	222056	1109	398	85
<b>4:3 NTSC Video Format</b>									
7' x 9'	6' x 8'	222005	\$1731	222016	\$365	222027	\$501	143	85 P+
8' 6" x 11'	7' 6" x 10'	222006	2571	222017	474	222028	581	152	85
10' x 13'	9' x 12'	222007	2796	222018	485	222029	650	276	85
11' 6" x 15'	10' 6" x 14'	222008	3012	222019	536	222030	746	286	85
13' x 17'	12' x 16'	222009	3239	222020	545	222031	749	312	85
16' x 21'	15' x 20'	222010	3711	222021	636	222032	932	340	85
19' x 25'	18' x 24'	222011	4310	222022	659	222033	1109	371	85

## Truss-Style Dress Kits with IFR Velour

Draper's Inherently Flame Retardant Velour never needs retreating. It is flame retardant for the life of the fabric (see page 74 for details). More resistant to wrinkling than standard Velour, yet 15% lighter weight for easier installation and fabric management. Complete Truss Dress Kit includes skirt, valance, valance bar, 2 drapes, 2 drapery bars and wheeled heavy-duty carrying case. Case dimensions are 15 5/8" x 20 1/2" x 84 1/4".

Overall Size	Image Area	Complete Dress Kit		Optional Adjustable Skirt Bar		Skirt Only		Complete Dress Kit Shipping Wt./lbs.	Freight Class
		Part No.	PRICE	Part No.	PRICE	Part No.	PRICE		
<b>16:9 HDTV Format</b>									
10' x 17'	9' x 16'	222154	\$2837	222049	\$545	222158	\$821	220	85
11' x 19'	10' x 18'	222155	3276	222050	567	222159	920	240	85
12' 3" x 21'	11' 3" x 20'	222156	3962	222051	636	222160	1020	293	85
14' 6" x 25'	13' 6" x 24'	222157	4244	222052	659	222161	1217	398	85
<b>4:3 NTSC Video Format</b>									
7' x 9'	6' x 8'	222136	\$1859	222016	\$365	222147	\$545	143	85 P+
8' 6" x 11'	7' 6" x 10'	222137	2690	222017	474	222148	636	152	85
10' x 13'	9' x 12'	222138	2933	222018	485	222149	710	276	85
11' 6" x 15'	10' 6" x 14'	222139	3162	222019	536	222150	818	286	85
13' x 17'	12' x 16'	222140	3422	222020	545	222151	821	312	85
16' x 21'	15' x 20'	222141	3938	222021	636	222152	1020	340	85
19' x 25'	18' x 24'	222142	4575	222022	659	222153	1217	371	85

# Pipe & Drape Runoffs

Free-standing modular drapery system for use with StageScreen, FocalPoint, Cinefold, and Ultimate Folding Screen portable projection screens. A variety of hardware and drapery configurations are available.

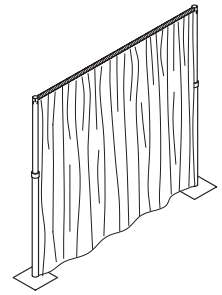

Pipe 2.0™ by Versatop™

PORTABLE SCREENS

	Net Wt.*/lbs.	Part No.	PRICE	Freight Class
<b>Telescopic Uprights With Slip-Lok Feature</b>				
3'-5' model	3	223001	\$152	85 P
7'-12' model	6	223002	172	85 P+
9'-16' model	7	223003	183	85
7'-17' three-piece upright.	14	223019	270	85 P
<b>Pipe 2.0® by Versatop™ Uprights</b>				
3'-5' model	3	223029	\$183	85
7'-12' model	6	223030	221	85
9'-16' model	14	223032	257	85
7'-17' three-piece upright.	7	223031	401	85
*Shipping notes: 1 to 10 uprights will ship in one 10 lb carton. (Studs can be packed with uprights.)				
<b>Flat Steel Bases &amp; Studs</b>				
3/8" x 18" x 18"	35	223004	\$137	85 P
3/16" x 18" x 18"	18	223005	95	85 P
(For use with telescoping uprights. Draper does not recommend the use of lighter bases with fabric panels 12' and higher.)				
*Shipping notes: Single pieces will ship at listed weight. Two or more bases will ship on one, 30 lb. skid.				
<b>Horizontal Drape Supports</b>				
6' / 8' / 10'	4	223007	\$75	85 P+
7' / 10' / 12'	3	223008	83	85 P+
Adjustable Drape Support Bracket	4	223021	42	85 P
<b>Pipe 2.0® by Versatop™ Telescopic Drape Supports</b>				
6' / 8' / 10'	3	223033	\$114	85
7' / 10' / 12'	3	223034	131	85
*Shipping notes: Single pieces ship in one, 10 lb. carton. Up to 25 pieces will fit in one, 10 lb. carton.				
<b>Replacement Parts</b>				
Upright Repair Ends for 2 pc upright	1	223009	\$17	85 P
Upright Repair Ends for 3 pc upright	1	223028	20	85 P
Horizontal Bar Repair End - Large Bar	1	C057.008	9	85 P
Horizontal Bar Repair End - Small Bar	1	C057.007	9	85 P
Collar Repair Kit for 2 or 3 pc upright	1	C121.026	127	85 P
Stud & Screw for Bases - 2" x 6"	1	223010	21	85 P
Stud & Screw for Bases - 2" x 4"	1	223027	21	70 P
<b>Carrying Cases</b>				
Zippered Pouch—Accommodates up to 12 uprights and/or horizontal supports.	8	223018	\$128	70 P
Heavy-Duty Carrying Case <sup>1</sup>	51	219200	678	250 P+
Optional Carrying Case <sup>2</sup>	30	219098	354	250 P+

<sup>1</sup> Case size is 15 5/8" x 20 1/2" x 84 1/2" and accommodates up to 4 drape panels @ 13' x 12' or 13' x 16'; or 8 panels @ 16' x 50".

<sup>2</sup> Case size is 16 3/8" x 17 1/4" x 60" and accommodates up to 2 drape panels @ 13' x 12' or 13' x 16'; or 6 panels @ 16' x 50".

## Draperies

Widths shown below are actual cloth width, to be reduced for fullness. Draper does not recommend more than one 13' panel per drape support.

- Standard 16 oz. Velour: Black cotton Velour, treated for flame retardancy. 20 oz. optionally available.
- Inherently Flame Retardant Velour: Draper's Inherently Flame Retardant Velour never needs retreating. It is flame retardant for the life of the fabric. More resistant to wrinkling than standard Velour.
- Vellite, Poly-Knit and Velour colors: Navy or Black.
- Classic Twill colors: Navy or Black, other colors available on request.

Size H x W	Black 16 oz. Velour (0.9 Opacity)		Inherently Flame Retardant Black Velour (0.9 Opacity)		Vellite (0.75 Opacity)	Classic Twill (0.5 Opacity)	Poly-Knit (0.5 Opacity)	Ship Wt./lbs.	Freight Class
	Part No.	PRICE	Part No.	PRICE	PRICE	PRICE	PRICE		
<b>Drape Panels</b>									
12' x 50"	223013	\$228	223023	\$290	--	--	--	10	70 P
16' x 50"	223014	306	223025	390	--	--	--	11	70 P
12' x 13'	223015	821	223022	945	\$745	\$593	\$455	18	70 P
16' x 13'	223016	972	223024	1163	897	703	547	23	70 P



# Presentation Easels

We're streamlining our easel product offering and keeping the best. Draper Heavy Duty Easels are designed to last, even under the wear and tear of rental use. The 1" square tubular aluminum frame stands up to the demands of constant setup, teardown, and transportation.

Model	Part No.	Description	PRICE	Shipping Wt./lbs.	Freight Class
DR890	350059	Our classic heavy-duty non-folding easel comes with silver anodized legs. Stands 6' tall and folds flat for storage or transportation.	\$485	31	125 P
DR890 Black	350070	Our classic heavy-duty non-folding easel is now finished in all black. The matte powder coat finish is highly scratch resistant. Stands 6' tall and folds flat for storage or transportation.	485	31	125 P
DR895	350061	Similar to the DR890, the DR895 stands 6' tall and features a satin silver leg finish with folding legs for more compact storage. The folding legs allow the entire unit to fold to a compact 6" x 29" x 39".	557	25	85 P
DR990	350068	This heavy-duty easel features a dry-erase writing panel and satin silver anodized frame. Stands 6' tall and folds flat for storage	485	25	125 P+

### Easel Accessories

	Part No.	PRICE
Dry Erase Accessory Kit	800319	\$30
Magnets (24 pack)	352008	33

### Easel Paper Pads

27" x 34", with rigid chipboard backing, 16 lb. plain white sulfite bond, without headstrip. Pads are securely bound at top, with 2 5/16" diameter holes on 17 1/2" centers. AV15 ships 50 sheets per pad, 4 pads per carton. AV-15-40 ships 40 sheets per pad, 5 pads per carton.

Model	Part No.	PRICE	Shipping Wt./lbs.	Freight Class
AV15	351001	\$53	20	55P+
AV15-40	351002	53	20	55P



DR990 Heavy-Duty Easel

PORTABLE SCREENS

#### Freight Class Key

**Number** LTL freight class  
**P** . . . . . Parcel Service  
**+** . . . . . \$15.00 surcharge  
 (over 48" long)

**Example:** a freight code of 125 P+ indicates an item that may ship as freight class 125 or via parcel service with \$15 surcharge.

# Rigid Rear Projection Screens

Draper offers several distinct types of rear projection screens—traditional diffusion, optical screens, and exclusive IRUS technology.

## DIFFUSION REAR SCREENS

A transparent substrate, either glass or acrylic, with a permanently bonded diffusion medium. The diffusion medium distributes projected light and creates a uniform high-resolution reproduction of the projected image. Cinescreen, Draper's diffusion rear screen, is unique among rear screens because its diffusion medium consists of both an optical coating and an optical tint—each formulated for specific requirements. (Optical coatings and optical tints are described on page 83)

The advantages of diffusion screens are superior clarity of image and availability in extremely large sizes. Accordingly, diffusion screens are great for high resolution applications.

### Cineglass®

Recommended for maximum sound isolation, scratch resistance, service life and any application that requires multiple projectors. Weighs approximately twice as much as acrylic, must be installed by a glazier. Recommended for wide and multiple projection installs.

### Cineplex®

Lightweight, durable and break resistant. Easier to install. Requires more care in cleaning, as acrylic scratches more easily than glass. Not recommended for multiple projection installs.

### VersaRoll

Draper now offers our standard rear screens, rolled up for shipping, whether you use the Cinescreen or IRUS product. The new VersaRoll frame solutions and lighter substrate provide a more cost effective shipping and handling solution and are a suitable option for blending when glass is not possible. The same great Cinescreen and IRUS coatings are still available with VersaRoll substrate and frame.

### Cinescreen®

Only Draper offers you a choice of optical coatings and unique optical tints. With a Draper Cinescreen, you can select the optimum combination of optical coating and tint based upon your projection equipment, audience seating pattern, desired contrast level, screen aspect ratio, ambient light level and aesthetic considerations. Only Draper offers you this versatility. Custom gains and tints are available by quotation. Draper uses the finest plate glass and clear acrylic as Cinescreen substrates. Virtually identical optical qualities.

When ordering a Cinescreen, we need to know the following:

- Dimensions
- Substrate
- Thickness
- Optical coating
- Tint
- If NonGlare is required
- If factory-installed frame is required (specify framing system and finish)
- Or contact Draper and let a Draper Consultant help you specify the proper product for your application.

### IRUS Technology

The Draper IRUS—Infinite Resolution Uniformity Screen—is specifically designed to provide maximum legibility with any projector. Today's projectors offer higher resolution than ever before—and that means more information for your audience to absorb. The IRUS is up to the challenge. In order to convey an increasing amount of information to the viewer, the IRUS uses proprietary technology to display the sharpest, most uniform image you've ever seen. An extra wide angle view makes this screen perfect for short throw projectors or blending applications.

### CUSTOM REQUIREMENTS

Draper offers many custom and unique possibilities with rigid front and rear projection screens, or even when projection is not used.

- Video Conferencing Camera Portal
- Rollable Rigid Rear Screens
- Curved Rigid Front or Rear Screens
- Custom Shapes
- Transparent Rear Screens
- Custom Coatings
- VideoWalls
- Zero Edge Framing System
- MultiScreen System
- Projector Support Structures and Custom Cube Stands
- See other custom options in the new Custom Audio Video Solutions section starting on page 93.

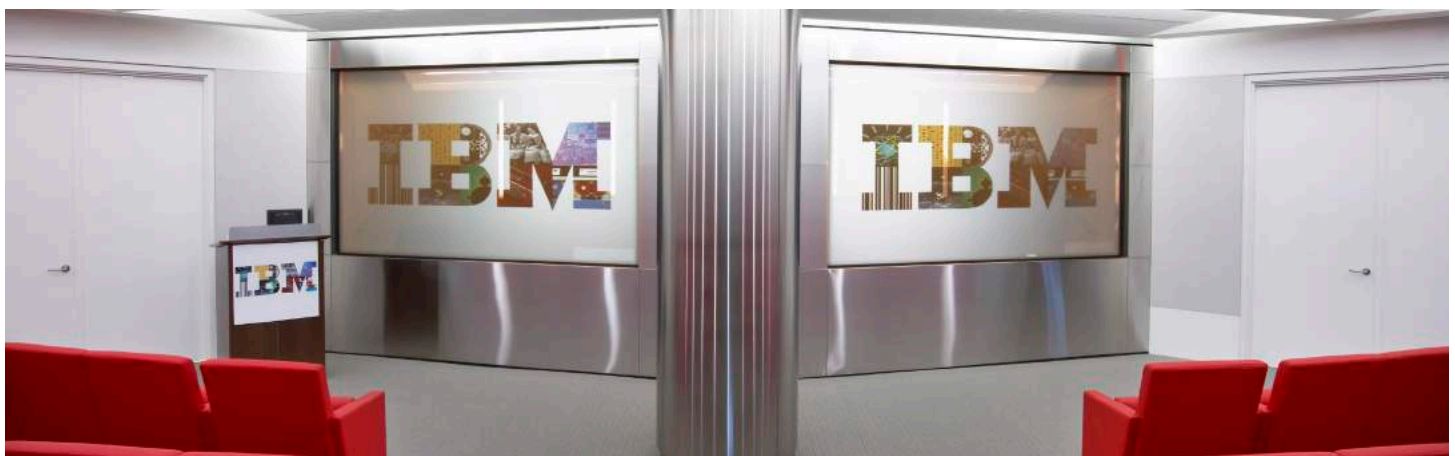

136" diag 16:9 - 1/2" Cineglass - 1.0 Gain , IBM Corporate Executive Center – New York, NY., Photography © Eric Laignel

# Rigid Rear Projection Screens

## IRUS—Infinite Resolution Uniformity Screen

The Draper IRUS is specifically designed for blending and wide viewing applications. Unique antiglare finish on glass or acrylic substrate with 0.7 gain and 180° viewing cone. IRUS is an improvement for every rear screen application, but is particularly suited for short throw projectors or blending images.

- **Substrates available:** Acrylic, Glass (for use with multiple projectors).

### IRUS with Curved or Semi Rigid VersaRoll

VersaRoll curved screens typically utilize 3/16" or 1/4" thick, IRUS substrate. Maximum standard size for 3/16" thick curved screens is 100" high by 360" wide. Minimum curve radius is 8'. Some tighter radius curves may require custom framing. Please call Draper for pricing and additional product details.

## Cinescreen® Rear Screens

Our optical coatings are specially formulated to your requested tint and gain. This advantage is at no extra charge to you.

### Cinescreen® with Curved or Semi Rigid VersaRoll

VersaRoll curved screens typically utilize 3/16" or 1/4" thick, Cinescreen® substrate. Maximum standard size for 3/16" thick curved screens is 100" high by 360" wide. Minimum curve radius is 8'. Some tighter radius curves may require custom framing. Please call Draper for pricing and additional product details. Call Draper to request a quote.

**Note: Adding frame changes overall Sizes.**

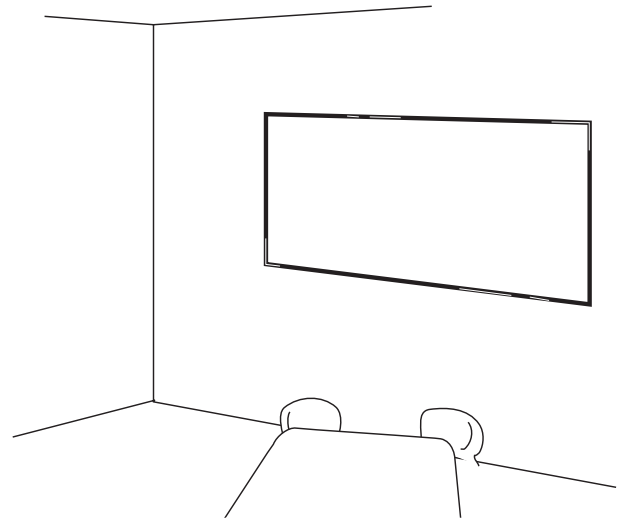

### Rear Screen Freight Information

#### Freight Damage Policy

It is the customer's responsibility to open the crate immediately, inspect and note any freight damage on the carrier's receiving bill of lading, while the driver is present. If no damage is noted, then it is your responsibility to report and file your own freight damage claim. The damaged product must be held at the original shipping address and in its original crate.

If the above procedure is not followed, or if the shipment is not insured, Draper cannot assume any responsibility for freight damage or collection of resulting claim. Please call for freight quote. Some large sizes require contract haul and also require special handling and framing considerations. Please discuss with Draper before you quote your customer.

#### Please Note

All rear screen returns and credits must be authorized by Draper, and a Return Material Authorization number must be issued. If a return is authorized, we will extend as much credit as possible for the screen based on its salvage value upon receipt by Draper.

#### Freight Class Key

**Number** LTL freight class  
**P** . . . . . Parcel Service  
**+** . . . . . \$15 surcharge  
 (over 48" long)

**Example:** a freight code of 125+ indicates an item that may ship as freight class 125 or via parcel service with \$15 surcharge.

### Optical Coatings and Tints for Cinescreen

Draper's optical coatings and unique optical tints allow you to select the optimum combination based upon your projection equipment, audience seating pattern, desired contrast level, screen aspect ratio, ambient light level and aesthetic considerations. Optical coating determines the brightness and viewing angle. Optical tint influences image contrast and color value.

#### Optical Coatings

- Cine 10: Gain of 1.0.
- Cine 13: Gain of 1.3.
- Cine 15: Gain of 1.5.

*Custom tints available. Contact Draper for details.*

#### Optical Tints

- HC** High Contrast (e.g. Cine 13HC)—Dark grey tint.
- NG** Standard formulation (e.g. Cine 13NG)—Medium grey tint.
- W** White (e.g. Cine 13W)—White optical tint.

*Custom tints available. Contact Draper for details.*

### Special Coatings

- **NonGlare**—Optional NonGlare coating on polished (uncoated) side of screen, call Draper.
- **ArmorKote**—Protective coating applied over diffusion coating, call Draper.
- **Custom coatings available**—call Draper for your special needs!

# Cineframe®

## Factory-Installed Frame for Glass and Acrylic Screens

Draper offers three factory-installed aluminum framing systems for both standard and custom size glass and acrylic screens. Pricing for several standard rear screens with framing systems included can be found in each rear screen model price grid. Please note size limits for various models in the dimensions chart at bottom.

Cineframe Dimensions	SYSTEM 200	SYSTEM 350	SYSTEM 400	VERSAROLL
Cinescreen or IRUS thickness	1/4", 3/8"	1/2"	All Sizes	3/16"
Cineglass through:	7' x 16'	All Sizes	All Sizes	--
Cineplex through:	7' x 16'	All Sizes	All Sizes	100" H X 30' W
IRUS through	7' x 16'	All Sizes	All Sizes	100" H X 30' W
Weight per linear foot	1 lb.	1 lb. 7 oz.	1 lb. 7 oz.	1 lb.

### Size Chart—

Add to image area to get overall frame size:	5 1/4"	3"	2 3/8"	3 1/8"
--	--------	----	--------	--------

\*This is the overall size of that portion of the System 400 Cineframe which is within the rough opening.

Refer to drawing below for complete dimensions. Recommended rough opening should be 3/8" larger than overall frame size.

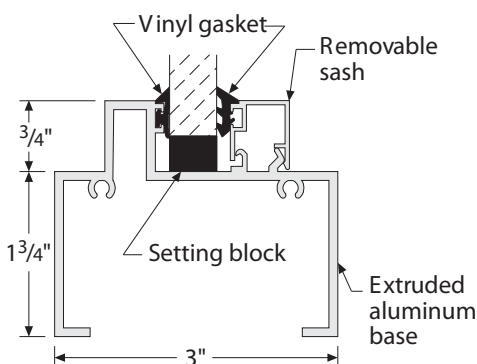

SYSTEM 200 dimensions

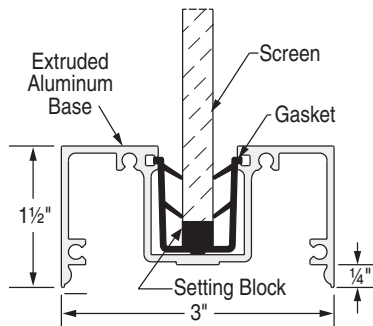

SYSTEM 350 dimensions

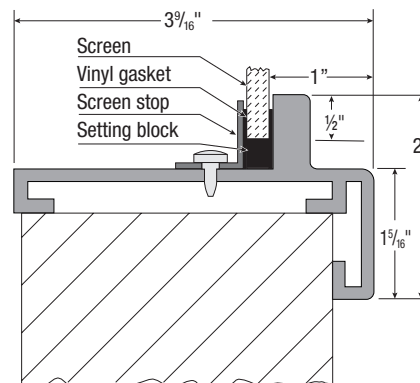

SYSTEM 400 dimensions

REAR SCREENS

## VersaRoll Screen

Same great optical choices of using the IRUS or Cinescreen but in a Semi Rigid 3/16" thickness. What you get with this product is an easy way to get a rigid screen into a building. Unroll once inside the room, attach fasteners, flatten in the hole opening, and you have a great product that does not move from air pressure changes. Call Draper for quotations Available up to 100" x 360" by quotation and wider choices may be available, discuss with your Draper representative.

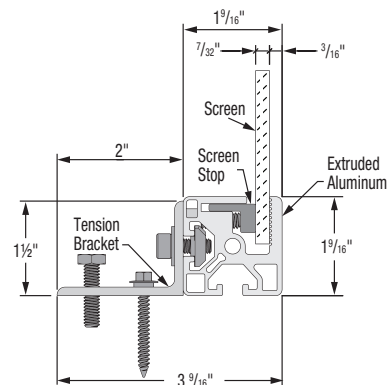

VERSAROLL dimensions

# Draper RPX Rear Projection System

The world's best engineered, most precise projector/first surface mirror mounting system. Easy to install, adjust and fine tune. Draper's RPX offers more product for your money. Its sturdy 1 3/4" x 1 3/4" aluminum extrusion allows incredible adjustment and easy assembly.

Each RPX consists of—

1. A cradle, with multi-axis adjustment, built specifically to fit your projector.
2. A high quality (94% reflective) first surface mirror.
3. A sturdy frame, built specifically for your requirement, to support and position the projector and mirror in precisely the right positions relative to the rear projection screen and to each other.
4. A 6-axis adjustment system is standard.

## RPX SYSTEM

Ship Wt./lbs.	PRICE
400	\$9018

**Mirror size may effect price. Call Draper for a drawing or quote.**

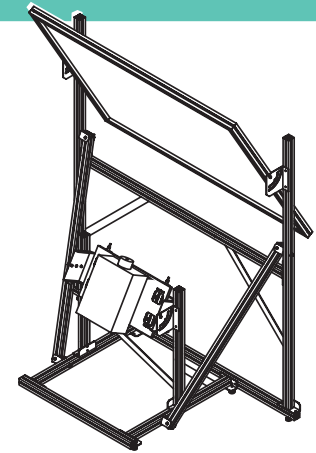

## Draper Rear Projection System

**RPX**—Designed for use with most projectors. Custom built to accommodate any required screen size or height.

# Mirror Manager

Available with any Mirror System or Draper RPX unit. The Mirror Manager allows you to fine tune the image within minutes, not hours. Individual adjustments for each corner or side of the image can be made with the turn of a knob.

Part Number	PRICE
254019	\$2412

As substitute for standard mirror and frame.

*Mirror Manager is available with First Surface Mirrors when sold separately. Price may increase for larger mirrors.*

# First Surface Mirrors

Draper first surface mirrors are 1/4" glass, optical grade, 94% reflective—the highest quality, commercially available first surface mirrors in the world. First surface mirrors are offered with or without frame. Frame is extruded aluminum with compression gasket to prevent distortion, in black anodized finish. Purchase of mirror complete with frame simplifies installation. Mirrors ship freight class 100. Custom sizes also available—call for quotation.

Mirror Size (H x W)	Mirror Only		Mirror Assembly Complete with Frame	
	Part No.	PRICE	Part No.	PRICE
30" x 40"	254002	3404	254010	\$6058
43" x 50"	254003	5194	254011	9082
43" x 60"	254004	7331	254012	10785
48" x 60"	254006	11619	254014	15096

# MiroClear

A superior quality cleaning and restoration kit designed specifically for all first surface glass mirrors. Improves image quality, maintains new mirrors to the highest standards, brings new life to older mirrors and restores reflectivity loss caused by dust, dirt, fingerprints and grimy build-up that accumulates and robs mirror of critical reflectivity.

Part No.	PRICE
254020	\$53

**Freight Class Key**

**Number** LTL freight class

**P** . . . . . Parcel Service

**+** . . . . . \$15 surcharge (over 48" long)

**Example:** a freight code of 125+ indicates an item that may ship as freight class 125 or via parcel service with \$15 surcharge.

## Design and Production Capabilities

Draper's project-oriented team designs and manufactures purpose-built products which deliver best-in-class results.

Draper brings a wealth of design and fabrication expertise to architects, consultants, and our system integrators through strategic partnerships with leading display manufacturers.

Draper focuses on design build opportunities with new construction and major retrofit projects while supporting a wide range of indoor and outdoor video wall and digital signage applications.



### WHAT

- Project-based business developing and selling purpose-built products
- Mounting solutions to interface buildings, workspaces, and technology
- Custom structures, frames, mounts, and trim for digital displays and more

### WHY

- We have a long history of custom engineering and manufacturing
- Consistent with rebranding message: focused on innovative solutions
- Revitalize Draper's relevancy in the AV marketplace and grow market share.

### HOW

- Through strategic partnerships with leading display manufacturers
- Draper brings a wealth of design and fabrication expertise to relationships
- Design-build opportunities with new construction and major retrofit projects



## CORE, ADVANCED AND TAILORED PRODUCTS

■ Draper has the capability and capacity to produce core, advanced and tailored solutions – in short, we can deliver you a solution that matches your unique needs, from the simplest of jobs to the most complex challenges. Our core product offerings are easy to order and deliver quickly on a short turnaround time. Our Advanced solutions take those core concepts a step further, offering with more options that help your solution adapt to more your specific needs. Tailored solutions offer the most flexibility for complex installations, allowing us to partner with you to find your perfect fit.



# Icon Ace Freestanding

The Icon Ace Freestanding creates a stable and reliable freestanding modular video wall perfect for events, retail, and corporate. Minimal components make this stylish unit easy to assemble. Fine XY/Z axis adjustment capabilities provide precise display alignment in all four corners. Height and width can be adjusted with millimeter precision for edge-to-edge mounting. This modular system allows multiple Icon Ace Freestands to be mounted side-by-side to create an extra-long video wall. Each display mount can be secured, with screws (included) or with padlocks (not included). The base can be bolted to the floor if required. Optional cladding can be ordered separately and is available for bottom, sides, and back. Contact Draper for pricing.

- Compatible video wall configurations: 2 x 2, 3 x 3, or 4 x 4.
- Maximum weight per display: 50 kg (110 lb).
- Available in 2 x 2, 3 x 3, or 4 x 4 size video wall.
- VESA pattern: 200 x 200 to 800 x 400.
- Finish: Textured grey powder coat.

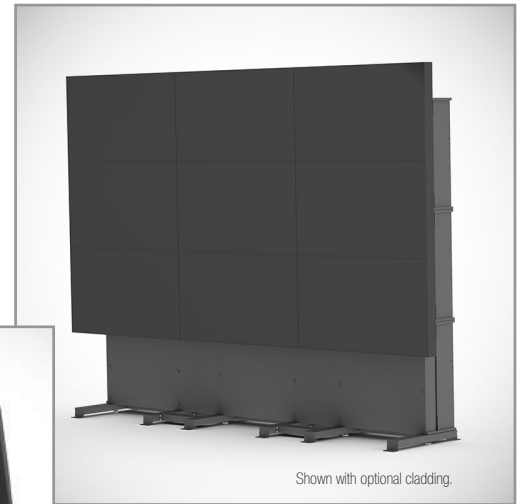

		PRICE
46" Displays	Part Number	Freight NOT Included
2 x 2	C140006-2A0	\$5168
3 x 3	C140004-2A0	10194
4 x 4	C140005-2A0	16278
55" Displays	Part Number	
2 x 2	C140003-2A0	\$5168
3 x 3	C140001-2A0	10194
4 x 4	C140002-2A0	16278

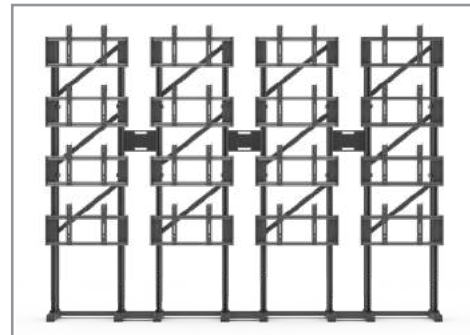

## Multi Display Wall Rails

The Multi Display Wall Rail simplifies mounting by utilizing one 78.75" (2,000 mm) long rail instead of multiple smaller rails for extra fast and accurate mounting. This provides a single installation with a continuous level mounting point for all displays in the row. One rail provides easier alignment regarding horizontal rows, and incorporating two rails makes vertical alignment of rows simpler. These aluminum wall rails can be cut to desired length in the field and combined. Attractive endcaps provide a nice finish. The Multi Display Wall Rail can be used with any of the video wall mount series.

		PRICE
Part Number	Description	Freight NOT Included
PW010016	MWD Rail 1 x 2000 mm	\$183
PW010006	MWD Rail 2 x 2000 mm	227



# Video Wall Mount

Video Wall Mounts provide a simple, cost-effective way of building a video wall of any dimension and shape with the aid of mounts designed to make exact alignment of each unit easy. Fine X/Y/Z axis adjustment capabilities provide precise display alignment in all four corners. Height and width can be adjusted with millimeter precision for edge-to-edge mounting. The final result lies closer to the wall than most other products on the market. Each display mount can be locked with screws (included) or with padlocks (not included) to increase public safety and reduce the risk of theft.

Part Number	Description	Screen Sizes	Max Load	PRICE
				Freight NOT Included
PW010001	<b>Video Wall Mount</b> - Recommended for 1-2 high arrays. VESA pattern: 100-400 mm vertically. 1 Bracket per display.	37" - 65"	220 lb (100 kg)	\$217
PW010003	<b>Portrait Video Wall Mount</b> - Recommended for 1-2 high arrays. VESA pattern: from 300 mm x 100 mm to 400 mm x 900 mm. 1 Bracket per display.	46" - 70"	220 lb (100 kg)	250
PW010010	<b>XL Video Wall Mount</b> - One bracket required per display, landscape and portrait. VESA pattern: 300-900 mm vertically and 300-900 mm horizontally.	70" - 82"	331 lb (150 kg)	267
PW010020	<b>Extendable Video Wall Mount</b> - No limitation on array height or width. VESA vertical pattern: 100-400 mm. 1 Bracket per display.	37" - 60"	88 lb (45 kg)	533



AV MOUNTS & STRUCTURES



## SPECIFICATIONS - SMARTTRIM™ FOR BARCO UNISEE®

SmartTrim is constructed of 0.08" (2 mm) aluminum and hardware of 11-gauge 0.118" (3.0 mm thick) steel, with a textured powder coat finish. Available in black, white or optional custom colors. Each trim section extends past the display edge no more than 4.53" (115mm) once installed. SmartTrim's design allows for smaller packaging, ease of handling by one person during installation and service, and simple expansion when adding more displays.

SmartTrim connection assembly hardware attaches to each Barco UniSee wall cross using the Barco service tool provided with the system. No other are tools are necessary. Trim is easily attached with guiding pins to ensure a proper fit and clicks securely into place with powerful magnets. Trim edges are padded with soft foam to help protect the UniSee displays.

Lower trim panel flanges are vented to allow for convection cooling. Vents are 2.45" x 0.24" (62 x 6 mm) with 0.35" (9 mm) spacing between the vent slots. Side trim panel flanges will be vented when the video wall array is greater than three displays high. Top trim panels do not include flanges to allow for maximum air flow, but are available as an option. Please note: it is the installer's responsibility to ensure the Barco UniSee video wall is installed correctly and always operating within Barco's published specifications for ambient conditions.

Standard trim flange depth is based on a flush wall-mount installation and allows for a nominal 0.25" (6.4 mm) gap between the trim and the wall. Standard trim depth is 2.75" (70 mm). If the UniSee video wall installation requires structural mounting support (e.g., Draper Mount Interface, Plywood backing, or Unistrut), additional flange depth will be needed and may be supplied upon request. Black finish standard, White is available upon request.

Patent information: available at [www.draperinc.com/legal/patents](http://www.draperinc.com/legal/patents)

Downloadable 3-part specifications: available at [www.draperinc.com](http://www.draperinc.com)

1x7	2x7	3x7	4x7	5x7	6x7	7x7
1x6	2x6	3x6	4x6	5x6	6x6	7x6
1x5	2x5	3x5	4x5	5x5	6x5	7x5
1x4	2x4	3x4	4x4	5x4	6x4	7x4
1x3	2x3	3x3	4x3	5x3	6x3	7x3
1x2	2x2	3x2	4x2	5x2	6x2	7x2
1x1	2x1	3x1	4x1	5x1	6x1	7x1

Most common sizes shown above. Prices for these common sizes shown below. Barco UniSee video wall and SmartTrim are scalable beyond 7 x 7 panels.

Description	Approximate Image Size	SmartTrim Kit Name	PRICE
* 16:9 Format	W x H (D), Excludes Trim	Black	Freight NOT Included
2 x 2"	7.96' x 4.48' (109.7" D)	ST2X2B	\$1514
2 x 3	7.96' x 6.72' (125.1" D)	ST2X3B	1815
2 x 4	7.96' x 8.96' (143.9" D)	ST2X4B	2059
3 x 2	11.95' x 4.48' (153.1" D)	ST3X2B	\$1997
3 x 3"	11.95' x 6.72' (164.5" D)	ST3X3B	2300
3 x 4	11.95' x 8.96' (179.2" D)	ST3X4B	2542
4 x 2	15.93' x 4.48' (198.6" D)	ST4X2B	\$2482
4 x 3	15.93' x 6.72' (207.5" D)	ST4X3B	2784
4 x 4"	15.93' x 8.96' (219.3" D)	ST4X4B	3026

Side trim flanges will be vented whenever the video wall array is greater than 3 displays high.

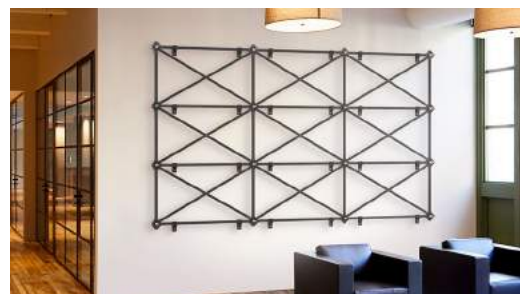
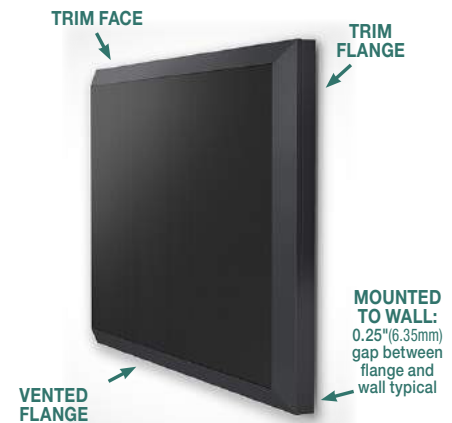

## Draper Mount Interface for Barco UniSee® Video Walls

This simple-to-install wall-mounting solution enables installation onto various wall construction types. The built-in precision alignment feature provides precise location of the Barco UniSee wall crosses, eliminating the need for additional wall-mounting hardware or substrates. Simple to use and lightweight—the mount interface can be installed by one person reducing on site installation costs. The configurable design will accommodate any Barco UniSee video wall array size, plus, when combined with the Draper® SmartTrim for UniSee trim kit, the solution is ideal for any Barco UniSee installation.

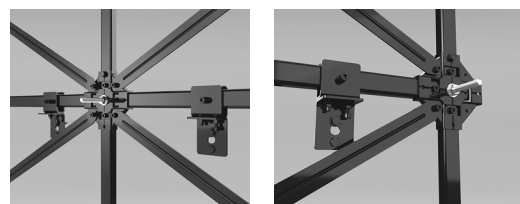

Description	Approximate Image Size	SmartTrim with Draper Mount Interface		Draper Mount Interface	
		Black	Freight NOT Included	Black	Freight NOT Included
* 16:9 Format	W x H (D), Excludes Trim				
2 x 2"	7.96' x 4.48' (109.7" D)	DMI2X2	\$967	ST2X2BDMI	\$2320
2 x 3	7.96' x 6.72' (125.1" D)	DMI2X3	1450	ST2X3BDMI	3026
2 x 4	7.96' x 8.96' (143.9" D)	DMI2X4	1934	ST2X4BDMI	3672
3 x 2	11.95' x 4.48' (153.1" D)	DMI3X2	\$1450	ST3X2BDMI	\$3207
3 x 3"	11.95' x 6.72' (164.5" D)	DMI3X3	2175	ST3X3BDMI	4116
3 x 4	11.95' x 8.96' (179.2" D)	DMI3X4	2901	ST3X4BDMI	4963
4 x 2	15.93' x 4.48' (198.6" D)	DMI4X2	\$1934	ST4X2BDMI	\$4096
4 x 3	15.93' x 6.72' (207.5" D)	DMI4X3	2901	ST4X3BDMI	5204
4 x 4"	15.93' x 8.96' (219.3" D)	DMI4X4	3867	ST4X4BDMI	6253

Side trim flanges will be vented whenever the video wall array is greater than 3 displays high.



# Projector & VC Camera Lifts / Cages

Draper offers the finest quality and widest variety of lifts, and continues to grow and innovate an unparalleled product line.

**Silent Partner**— Lockable enclosure designed to hold projectors from 5,000 to 15,000 ANSI lumens and reduce fan noise. See page 91.

**Fly Cages and Stackers**— Sturdy long-lasting protection for valuable projectors in multiple sizes. See page 91.

**Credenza Lift**—Draper's motorized projector lift designed to hide your projector inside cabinetry, and raise it at the touch of a button. See page 93.

**Custom Lifts**—You provide the inspiration, and we will custom design a lift system to meet your need. See page 92.

**Acrobat**— Motorized assembly lowers entire screen or other equipment from the ceiling using steel cables. See page 92.

**Micro Projector Lift**—Designed to fit within a 2' x 2' ceiling grid system. Lowers the projector up to 4' with three sets of scissors. UL approved. See page 93.

**LCD Lift**— Compact projector lift with bomb bay door closure. Available in two sizes. Furnished complete with Environmental Airspace Housing. See page 93.

**Scissor Lift**—Draper's Scissor Lift SL and SLX are UL approved. With travel distances from 4' to 28', there is a Scissor Lift to fit a vast range of needs. See page 94.

**Revelation**—This unique projector mount permanently conceals the projector above the ceiling and hides its noise as well. See page 95.

**AeroLifts**—Three models with a simplified design to install in even the tightest spots. UL approved! See page 96.

**Video Conferencing Camera Lift: Ceiling**—To raise and lower video conferencing camera from ceiling behind projection screen. See page 97.

**Video Conferencing Camera Lift: Credenza**—To raise and lower video conferencing camera from inside cabinetry or table. See page 97.

**Controls for Projector Lifts**—See page 98.



**Scissor Lift SLX24**

## DRAPER PRO PORTAL







### Online Projector Lift Selector

Draper's online Projector Lift Selector allows you to quickly and easily see what projector lift best suits your needs.

register at: [DraperInc.com/DraperPRO](http://DraperInc.com/DraperPRO)

## Draper Projector Lifts

PROJECTOR & CAMERA LIFTS

Model	Required Height above ceiling (inches)	Overall Size (inches)	Travel Distance	Lifting Capacity (lbs.)	Special Features
 <b>MPL</b>	varies	23 1/2" x 23 1/2"	4'	35	Fits within a 2' x 2' ceiling grid system
<b>LCD A</b>	17 3/4"	24 1/2" x 24 1/2"	Projector right below ceiling	65	Bomb bay doors; furnished complete with Environmental Airspace Housing and ceiling closure
<b>LCD B</b>	22 3/4"	29 1/2" x 29 1/2"	Projector right below ceiling	65	Bomb bay doors; furnished complete with Environmental Airspace Housing and ceiling closure
<b>Revelation A</b>	13 5/8"	38 1/4" x 34"	N/A	100	Conceals the projector above the ceiling
<b>Revelation B</b>	13 5/8"	38 1/4" x 44"	N/A	100	Conceals the projector above the ceiling
 <b>Scissor Lift SL</b>	varies	24" x 24"	4'–12'	100	Fits within a 2' x 2' ceiling grid system; "store", "show" and "service" positions
 <b>Scissor Lift SLX</b>	varies	37 1/8" x 38 5/8"	10'–28'	350	"Store", "show" and "service" positions
 <b>AeroLift 35</b>	varies	23 1/2" x 14 1/8"	24 1/2"	35	Installs in even the tightest spots
 <b>AeroLift 100</b>	varies	29 1/2" x 29 1/2"	38 1/2"	100	Installs in even the tightest spots
 <b>AeroLift 150</b>	varies	29" x 39 1/2"	38 1/2"	150	Installs in even the tightest spots

# Silent Partner

Reduce the distraction of projector fan noise in a home cinema/theater, higher education classroom, auditorium, or boardroom/conference room application. Silent Partner's acoustic insulation foam reduces projector noise. The enclosure is designed to hold projectors from 5,000 to 15,000 ANSI lumens. It mounts beneath most ceilings or can be attached to a projector lift to conceal the unit when not in use. Lockable access doors provide easy projector service and added security.

## Features

- Available in three sizes: Model A: 5K-8K lumens, Model B: 8K-10K lumens, and Model C: 10K-15K lumens
- Exhaust labyrinth for optimum noise attenuation reduces projector noise by 20–25 dBA
- Thermostatic fan control with sensitivity adjustment for noise and temperature optimization
- Electrostatic inlet air filters
- Removable and lockable side and back access doors with optical grade port glass.
- Easy install for ceiling, lift, or tabletop. Projector clamp firmly holds projector for tabletop or ceiling orientation
- Can be attached to lifts for concealment when not in use
- Inboard transformer accepts both 110v and 220v

Description	White Part. No.	PRICE	*Black Part. No.	PRICE
Model A	300387	\$11262	300386	\$13229
Model B	300389	12362	300388	14331
Model C	300391	13469	300390	15438

\*White version in stock. Black version requires 4-6 weeks lead time.

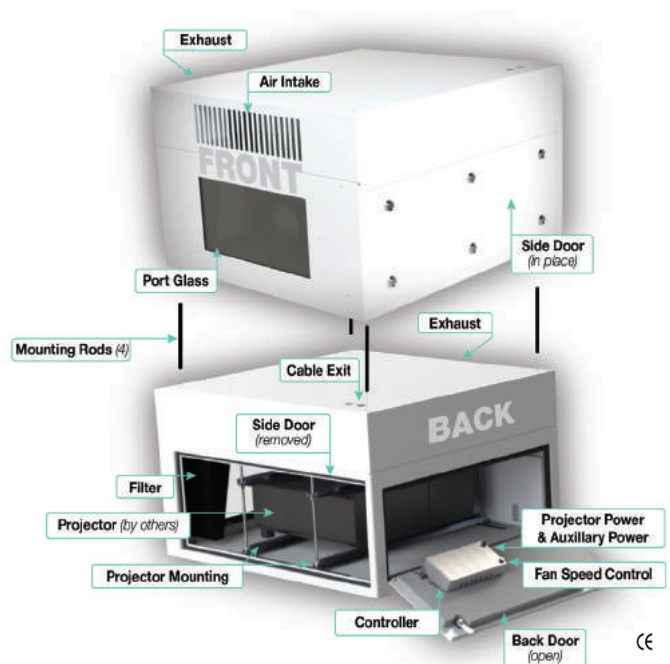

# Fly Cages and Stackers

Sturdy long-lasting protection. Draper Fly Cages are available in several sizes and designed to provide sturdy, dependable, long-lasting rigging for your valuable projectors. Manufactured from 2" (5 cm) tubing, Draper fly cages easily attach to cheeseborough clamps for quick and secure mounting to truss. Includes stacking pins to stack cages up to three high.

## Features

- 5 standard size configurations fit most projectors
- The cages can be custom made to fit any size projector
- Include 3 axis adjustment (roll, tilt, yaw) mechanism to help with image alignment
- Include pins to allow cages to be stacked for increased projector brightness or redundancy
- Extremely rigid and strong frame

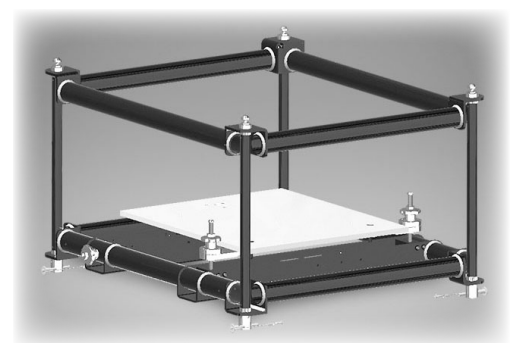

Size	Fits Projector Sizes	PRICE
Small	<35" L x <19" W	\$4901
Medium	<35-38" L x <19-26" W	5951
Large	<38-50" L x <26-29" W	6651
Wide-Small	<23" L x <24" W	4901
Wide-Large	<23-25" L x <24-30" W	5951

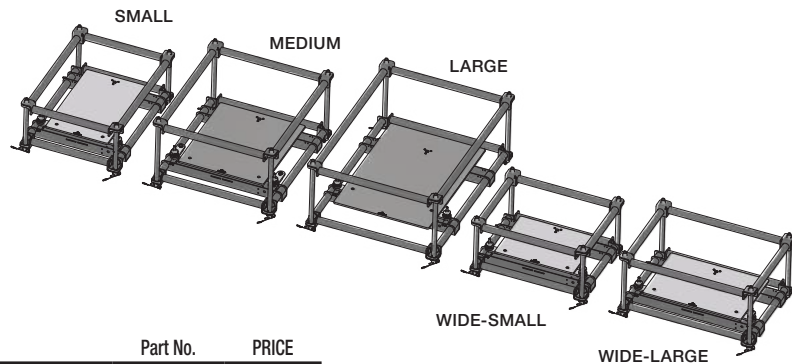

Custom configuration available be request. Call for pricing.

Fly Cage Accessories	Part No.	PRICE
1.5" Pipe Adapter - For hanging a single cage and projector from 1.5" pipe.	232179	\$522
One Clamp Adapter - For hanging fly cage and projector from a single clamp. Holds up to 2 cages stacked. 1,100 lb capacity.	232178	358
One Clamp Pack - Cheeseborough type clamp attaches fly cages to 1.66"-2" OD truss pipe.	232180	150
Four Clamp Pack - Cheeseborough type clamp attaches fly cages to 1.66"-2" OD truss pipe.	232181	565

# Custom Lifts

Do your customers ever ask for help concealing their AV equipment? Do they ask for mechanisms you've never seen before? Draper can help!

Draper's Custom Lifts are not based on standard lift products, but rather are custom designed to fit any need. Whether you want to conceal a single video conferencing camera or you want 20 flat panel displays to move in concert, Draper's Custom Lifts can help. **You provide the inspiration, and we will design a customized lifting system to fit your need.** The possibilities are endless. If you have a requirement not easily addressed by Draper's or other manufacturers' standard lift products, give us a call. We'll consider anything.

## What products would you like to conceal?

- Projectors
- LED, LCD, OLED displays
- Videoconferencing cameras
- Speakers
- Microphones
- Computer monitors and keyboards
- Document cameras
- Controls, touch panels and remotes

## Where would you like to conceal them?

- Walls
- Ceilings
- Floors
- Tables
- Credenzas
- Cabinets
- Furniture

## How would you like your lift to move your product?

- Lift up
- Drop down
- Pull out
- Swing down
- Swivel
- Pivot
- Turn
- Rotate

## How would you like to control your Custom Lifts?

- RF Remote
- IR Remote
- Touch pad
- Wall Switch

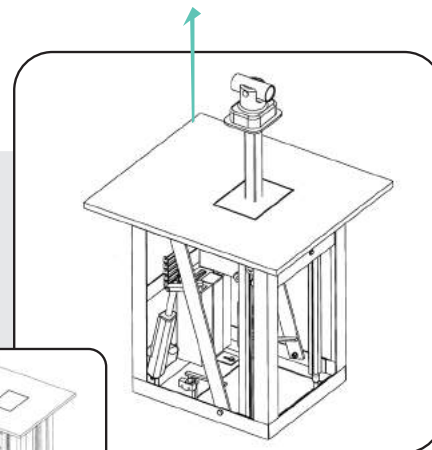

Videoconferencing camera concealed in table, then raised for use.

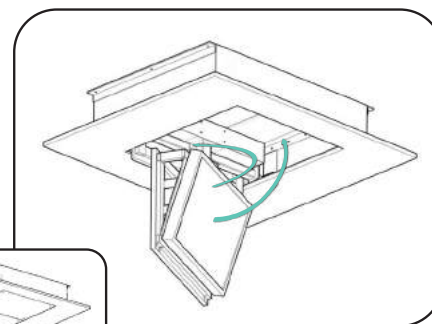
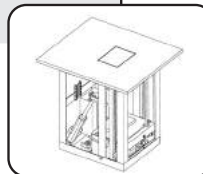

Flat panel display pivoted down and rotated.

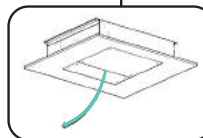

# Acrobat

Raise and lower a wide range of products, including projection screens

- Utility line set system consists of: Motor end assembly, Idler end assembly, drive pipe, and lift cables
- Order as a complete assembly, or select sub-assemblies to address unique job site requirements.
- Lower projection screens or other equipment up to 34 feet, eliminating the need for an extensive amount of black drop.
- Standard lift capacity up to 1000 pounds.
- Control options range from a basic wall switch to contact closure.
- **SAFETY FEATURE** – Motor and idler end assemblies are each fitted with a safety belt to keep the screen from falling should the cable fail.

Acrobat can also be used to raise and lower a wide range of products commonly used on stages, in gymnasiums and churches and other public venues, including –

- Lighting
- Speakers
- Backdrops
- Background sets
- Scenery
- Draperies
- Curtains
- Scrim
- Signs
- Banners
- Flags
- Chandeliers

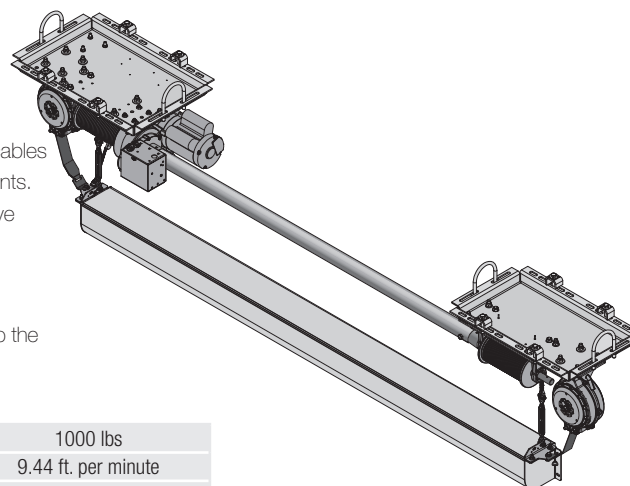

Lift Capacity	1000 lbs
Operating Speed	9.44 ft. per minute
Maximum Vertical Travel	34 ft.

## COMPLETE ACROBAT ASSEMBLY

Description	PRICE
To raise and lower Targa, Targa XL, Premier, Premier XL, Paragon E, or Paragon V screens	\$12071
To raise and lower StageScreen or other devices, please call for quotation.	
<b>Note – Price valid for any width of screen and any vertical travel up to 34 ft. and includes electrical cable management system and 110v operating switch. Custom sized screens do not include cable management system and must be specified as needed.</b>	
Add low voltage controller to control the Acrobat.	\$642

# Credenza Projector Lift

The Credenza Lift conceals your projector in a credenza, cabinet, or table and raises it quietly into position when it's time for the presentation to begin. When concealed, your projector is protected and out of the way. Features 12" vertical travel and a small footprint, making it easy to install in virtually any conference room furnishings. Includes single wall switch. Weight limit is 100 lbs.

Travel Range	Part No.	PRICE	Interior Shelf Dimensions	Shipping Wt. /lbs.	Freight Class
12"	300450	\$3611	20"w x 10"h x 20"d	30	85 P

Custom sizes are also available. Please call Draper for additional information and pricing.

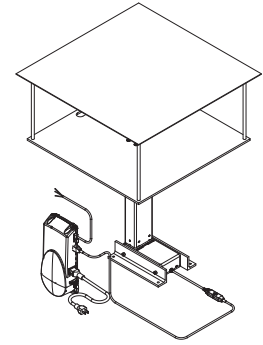

# Micro Projector Lift

Draper's MPL fits within an existing 2' x 2' ceiling grid. Three sets of scissors stabilize projector laterally and front-to-back. The Micro Projector Lift lowers down to the maximum of 48". Lifting capacity is 35 lbs. UL-approved. The MPL has a retracted height of only 5" (without projector, Environmental Airspace Housing, or closure).

- **Options:** See page 98 for control options.

Draper will furnish and factory install cables for your projector's HDMI, RGBHV, Video, and control. Includes mating trim wiring.

Model	Part No.	PRICE	Shipping Wt./lbs.	Freight Class
MPL	300198	\$4071	39	77.5 P

## Micro Projector Lift Optional Accessories

Description	White Part No.	Black Part No.	PRICE
Factory-installed cables for HDMI, RGBHV, Video, and Control	--	--	\$1300
Environmental Airspace Housing	300200	300573	1044
Ceiling Closure Panel	300201	300574	678
Ceiling Finish Kit (Consists of ceiling closure panel and mating trim ring)	300202	300575	1139
Universal Projector Mount, White (maximum load of 26 lbs)	300212	--	365

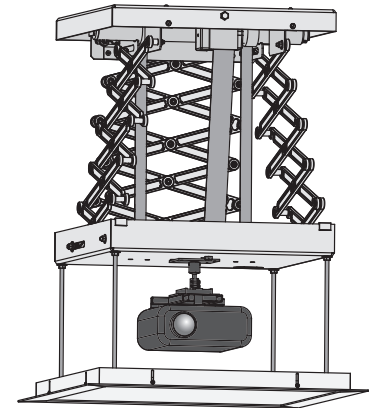

Shown with optional ceiling closure panel. 

Please see the Micro Projector Lift Planning sheet [draperinc.com/go/mpl.htm](http://draperinc.com/go/mpl.htm).

# LCD Lift

Draper's LCD Lift is compact and accommodates most LCD/DLP projectors. Bomb Bay doors open into the room, and the projector descends with the lift's traveling pan. Or choose the LCD Lift with flat closure. Flat closure can accept ceiling tile to match surrounding ceiling. LCD Lift comes with Environmental Airspace Housing and Bomb Bay or Flat Ceiling Closure in one part number.

- **Options:** See page 98 for control options.

Model	Bomb Bay Doors	PRICE	Flat Closure	PRICE	Shipping Wt./lbs.	Freight Class
	Part No.		Part No.			
LCD Lift A	300031	\$3916	300037	\$4122	95	150 P
LCD Lift B	300051	4216	300058	4423	130	150 P

## LCD Lift Optional Accessories

Description	Part No.	PRICE
Factory Installed Cables (HDMI, RGBHV, Video, Control)	--	\$1042
Universal Projector Mount, White (maximum load of 26 lbs)	300212	365

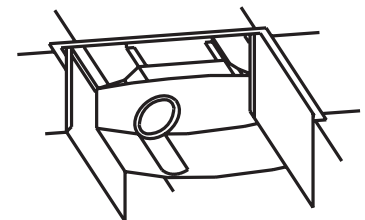

# Scissor Lifts

Draper's SL & SLX Scissor Lifts (11 distinct models) offer UL approval, easier installation, adjustment, and maximum travel ranges from 4' to 28'. SL Scissor Lifts fit perfectly in a 24" x 24" (60 cm x 60 cm) grid ceiling. Three position settings for "store", "show", and "service" are easy to adjust during installation.

**Three sets of scissors**—an exclusive Draper feature—assure both lateral and front-to-back stability.

The lifting capacity of the SLX is 350 lbs. (159 kg); the SL lift capacity is 100 lbs. (45 kg). Projector can be mounted using optional compact universal-style mount (maximum load of 26 lbs), or bolted directly to the lift's bottom plate. SL and SLX have white finish standard. Available in black finish, specify at ordering.

Scissor Lift SL Models	Height of lift in closed position <sup>1</sup>	Max. down travel (service position)	Part No.	PRICE	Shipping Wt./lbs.	Freight Class
SL4	8" (20 cm)	4' (1.2 m)	300270	\$6055	113	77.5 P
SL6	10" (25 cm)	6' (1.8 m)	300271	6471	123	77.5 P
SL8	12" (30 cm)	8' (2.4 m)	300272	7096	131	77.5 P
SL10	14" (36 cm)	10' (3 m)	300273	7515	141	77.5 P
SL12	16" (41 cm)	12' (3.6 m)	300278	7933	146	77.5 P

Scissor Lift SLX Models	Height of lift in closed position <sup>1</sup>	Max. down travel (service position)	Part No.	PRICE	Shipping Wt./lbs.	Freight Class
SLX10	14 1/16" (36 cm)	10'7" (3.2 m)	300250	\$8350	343	77.5
SLX14	16 5/16" (41 cm)	14'2" (4.3 m)	300251	9287	353	150
SLX17	18 9/16" (47 cm)	17'8" (5.4 m)	300252	11072	355	150
SLX21	20 13/16" (53 cm)	21'3" (6.5 m)	300253	11962	364	150
SLX24	23 1/16" (59 cm)	24'9" (7.5 m)	300254	14193	395	150
SLX28	25 5/16" (64 cm)	28'5" (8.7 m)	300255	15863	425	150

<sup>1</sup> Overall height of projector, optional mount, optional ceiling closure, and optional Environmental Air Space Housing all add to the overall height of equipment installed above ceiling.

## Scissor Lift SL Accessories

	White Part No.	Black Part no.	PRICE
(SL) Ceiling Finish Kit (18 1/4"W x 21 19/16"L projector space)	300286	300579	\$1202
(SL) Ceiling Closure Panel (18 1/4"W x 21 19/16"L projector space)	300291	300580	939
(SL) Environmental Airspace Housing (18 1/4"W x 21 19/16"L projector space)	300282	300581	1335
(B) Ceiling Finish Kit (28 1/8"W x 25 3/8"L projector space)	300284	300582	1202
(B) Ceiling Closure Panel (28 1/8"W x 25 3/8"L projector space)	300289	300583	939
(B) Environmental Airspace Housing (28 1/8"W x 25 3/8"L projector space)	300280	300584	1335
(E) Ceiling Finish Kit (25 1/8"W x 38 3/8"L projector space)	300285	300585	1202
(E) Ceiling Closure Panel (25 1/8"W x 38 3/8"L projector space)	300290	300586	939
(E) Environmental Airspace Housing (25 1/8"W x 38 3/8"L projector space)	300281	300587	1335
(U) Ceiling Finish Kit (34 7/8"W x 26 1/8"L projector space)	300287	300588	1202
(U) Ceiling Closure Panel (34 7/8"W x 26 1/8"L projector space)	300292	300589	939
(U) Environmental Airspace Housing (34 7/8"W x 26 1/8"L projector space)	300283	300590	1335
Optional Current Sensor	300382	300384	313

## Scissor Lift SLX Accessories

	White Part No.	Black Part no.	PRICE
SLX Ceiling Finish Kit (35"W x 39"L projector space)	300264	300591	\$1202
SLX Ceiling Closure Panel (35"W x 39"L projector space)	300265	300592	939
SLX Environmental Airspace Housing (35"W x 39"L projector space)	300266	300593	1335
SLXR Ceiling Finish Kit (35"W x 45"L projector space)	300293	300594	1202
SLXR Ceiling Closure Panel (35"W x 45"L projector space)	300294	300595	939
SLXR Environmental Airspace Housing (35"W x 45"L projector space)	300295	300596	1335
Optional Current Sensor	300382	300384	313

## Factory Installed Cables for Scissor Lift

	Part No.	PRICE
Factory installed cables (HDMI, RGBHV, Video, & Control) for SL	—	\$1300
Factory installed cables (HDMI, RGBHV, Video, & Control) for SLX10-SL17	—	1470
Factory installed cables (HDMI, RGBHV, Video, & Control) for SLX21-SLX28	—	1869

Standard Controls



Show Position Switch 121246



Key Operated Switch for Service Position 121022

Additional Controls Available— See page 98.

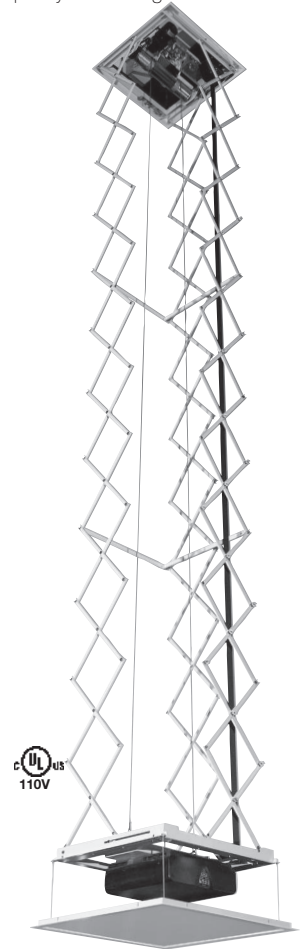

## Universal Projector Mounts

Description	White Part No.	Black Part No.	PRICE
Mount for SL-White (26 lbs. or less)	300212	N/A	\$365
Multiple Axis Adjustment Projector Mount (Medium, for SL & SLX) For weights 26-200 lbs.	300454	300453	735
Multiple Axis Adjustment Projector Mount (Large, for SLX) For projectors above 200 lbs. -Black	N/A	-	3589

# Max Projector Sizes

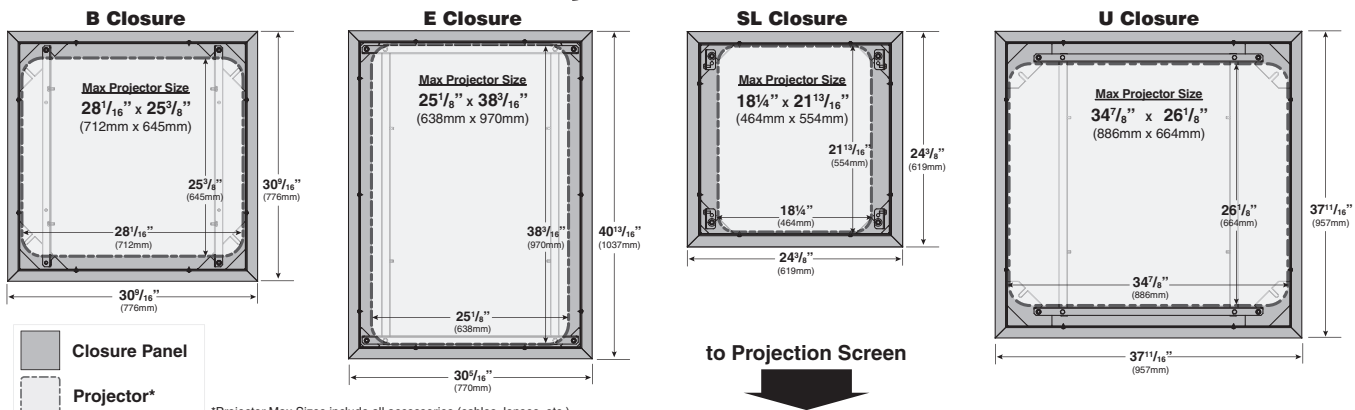

\*Projector Max Sizes include all accessories (cables, lenses, etc.)

# Revelation

Motorized Ceiling-Recessed Projector Mount. With a Revelation, the projector is permanently concealed above the ceiling. You won't see or hear the projector. Revelation's lower mirror fits into a 2' x 2' grid style ceiling. Mirrors are optical grade glass—94% reflective. 220v version available.

Visit <http://draperinc.com/go/RevelationPlanSheet.htm> for a planning sheet.

- **Options:** See page 98 for control options.



Revelation	Part No.	PRICE	Ship Wt./lbs.	Freight Class
<b>With Environmental Airspace Housing</b>				
Model A	300027	\$5950	189	150
Model B	300023	6055	209	150
<b>Without Environmental Airspace Housing</b>				
Model A	300025	\$4333	186	150
Model B	300019	4489	170	300
<b>Environmental Airspace Housing Only</b>				
Model A	300014	\$1775	43	300 P
Model B	300021	1775	89	300 P

## Revelation Optional Accessories

Revelation Accessory	Part No.	PRICE	Ship Wt./lbs.
Revelation Shield	300030	\$950	13
MiroClear	254020	50	3
<b>Ceiling Access Doors</b>			
White Finish	300007	\$447	35
Accepts Ceiling Tile	300008	813	25

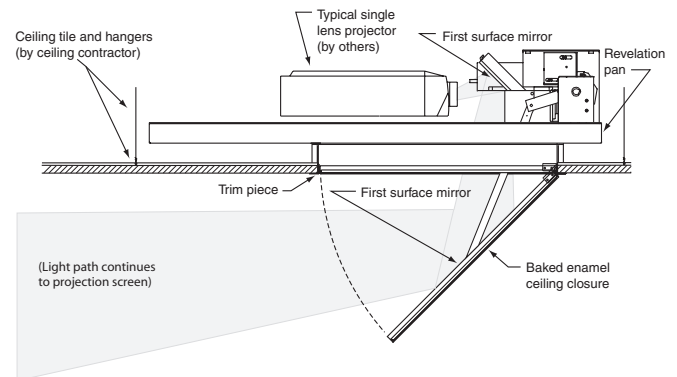

## Revelation Shield

Made of anti-reflective glass and installed between the first and second mirror/ceiling closure. The Shield serves two valuable purposes: It reduces projector noise in the audience area by more than 80%, and it prevents dust, dirt, grease, or other harmful substances from reaching the projector. Virtually none of the projected light is lost as it passes through the Shield.

## MiroClear

A superior quality cleaning and restoration kit designed specifically for all first surface glass mirrors. Improves image quality, maintains new mirrors to the highest standards, brings new life to older mirrors, and restores reflectivity loss caused by dust, dirt, fingerprints, and grimy build-up that accumulates and robs mirror of critical reflectivity.

## Ceiling Access Door

If you plan to install your Draper Projector Lift above a finished ceiling, these access doors provide above-the-ceiling access for cleaning, maintenance, or repairs without damage to the ceiling. Available with a white painted finish, or recessed to accept ceiling tile.

### Freight Class Key

- Number** LTL freight class
- P** . . . . . Parcel Service
- +** . . . . . \$15 surcharge (over 48" long)

**Example:** a freight code of 125 P+ indicates an item that may ship as freight class 125 or via parcel service with \$15 surcharge.

# AeroLift

The cleverly designed AeroLift keeps overall footprint and height to a minimum. All models are UL listed! Choose your model based on desired weight capacity: 35, 100 or 150 pounds. The AeroLift is powered by a motor-in-roller design, and features a stabilizing arm which can also be used for cable management. Built-in adjustability allows you to deal with job site conditions quickly and easily. Projector may be mounted flush to bottom pan.

**Note: The AeroLift may also be used to recess speakers, security cameras, video conferencing cameras, or document cameras.**

- **Options:** See page 98 for control options.

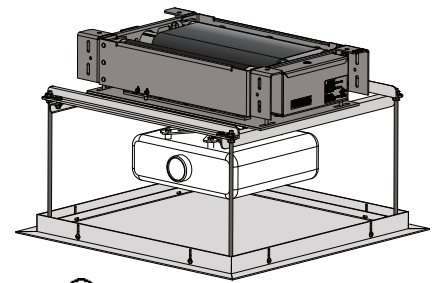

AeroLift 35 shown with optional small closure panel

Model	Lifting Capacity (lbs.)	Travel Distance	 Part No.	PRICE	Shipping Wt./lbs.	Freight Class
AeroLift 35	35	24 1/2"	300319	\$3128	36	77.5
AeroLift 100	100	38 1/2"	300321	4384	52	77.5
AeroLift 150	150	38 1/2"	300323	5531	84	77.5

## AeroLift Optional Accessories

Accessory Description	White Part No.	Black Part No.	PRICE	Shipping Wt./lbs.
<b>For AeroLift 35</b>				
Small Environmental Airspace Housing (14 <sup>9</sup> / <sub>16</sub> " x 23 <sup>7</sup> / <sub>8</sub> ")	300222	300576	\$627	42
Small Ceiling Closure Panel (15 <sup>5</sup> / <sub>8</sub> " x 25")	300223	300577	680	10
Small Ceiling Finish Kit	300224	300578	835	15
Large Environmental Airspace Housing—23 1/2" x 23 1/2"—For 2' x 2' grid ceiling (same as Micro Projector Lift option)	300200	300573	1044	32
Ceiling Closure Panel—For 2' x 2' grid ceiling (same as Micro Projector Lift option)	300201	300574	678	12
Ceiling Finish Kit (Closure and trim ring)—For 2' x 2' grid ceiling (same as Micro Projector Lift option)	300202	300575	1139	27
<b>For AeroLift 100</b>				
Environmental Airspace Housing	300280	300584	\$1335	118
Ceiling Closure Panel	300289	300583	939	26
Ceiling Finish Kit (Closure and trim ring)	300284	300582	1202	40
<b>For AeroLift 150</b>				
Environmental Airspace Housing	300281	300587	\$1335	145
Ceiling Closure Panel	300331	--	939	37
Ceiling Finish Kit (Closure and trim ring)	300334	--	1202	45
<b>For All AeroLifts</b>				
Ceiling Access Door for above-ceiling access. White Finish.	300007	--	\$447	35
Ceiling Access Door to accept ceiling tile for above-ceiling access.	300008	--	813	25
Universal Projector Mount (maximum load of 26 lbs)		300215	365	6
Multiple Axis Adjustment Projector Mount (Medium, For Aerolift 100 and 150) For projectors 26-200 lbs.	300454	300453	735	

## AeroLift Video Conferencing Camera Shelf and Closure

The Video Conferencing Camera Shelf and Closure enables the installation of the video conferencing camera of your choice on the AeroLift 35. This shelf ensures that the structure to mount the ceiling closure is out of the camera's field of view. The foot print is smaller to better match the dimensions of a camera. It is a clean, simple way to mount your camera and then conceal in the ceiling.

Accessory Description	White Part No.	Black Part No.	PRICE	Shipping Wt./lbs.
<b>Video Conferencing Closure /Shelf and Plenum for AeroLift 35 only</b>				
Plenum	300216	300217	\$627	10
Closure/Shelf	300218	300219	834	42

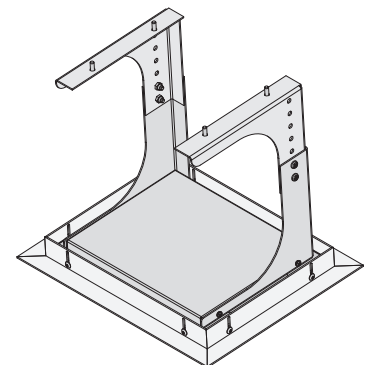

PROJECTOR & CAMERA LIFTS

### Freight Class Key

**Number** LTL freight class  
**P** . . . . . Parcel Service  
**+** . . . . . \$15 surcharge (over 48" long)

**Example:** a freight code of 125 P+ indicates an item that may ship as freight class 125 or via parcel service with \$15 surcharge.



## Video Conferencing Camera Lift: CEILING

Draper's ceiling Video Conferencing Camera Lift (VCCL/Ceiling) is a unique product designed expressly for video conferencing cameras. It conceals the camera just above the ceiling when not in use, lowering it into position immediately below the bottom edge of a ceiling mounted projection screen in "down" position. Ceiling-recessed case features motorized door closures and installs directly behind screen case.

The VCCL/Ceiling can be used with any ceiling-recessed projection screen and has a vertical travel down to 120" with infinite adjustability. Maximum camera size\* 14" W x 9" D x 8" H. Add \$70 per lineal ft. if you want VCCL/Ceiling case and screen case to be exactly the same width. Includes built-in LVC-IV with LVC-S switch. See page 98 for other control options.

Travel Range	PRICE	Case Dimensions length
120"	\$9777	Base cost for 77" case

\* Contact Draper for alternative solutions for larger cameras.

PRICE		
Factory Installed Cables	\$1074	Draper will install up to two cables (HDMI, CAT6) on lift.

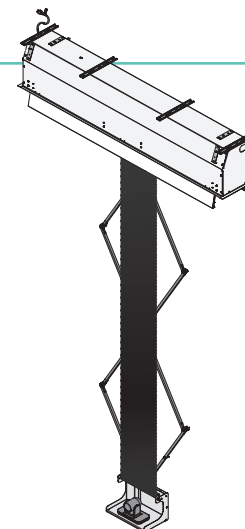

## Video Conferencing Camera Lift: CREDENZA

The Video Conferencing Camera Lift - Credenza conceals your camera in a credenza, cabinet, or table and raises it quickly and quietly into position when it's time for a conference to begin. When concealed your video conferencing camera is protected and out of the way.

Draper's Video Conferencing Camera Lift - Credenza features 10" vertical travel and a small footprint, making it easy to install in virtually any conference room furnishings. Two interior shelf sizes available to accommodate almost any video conferencing camera. Interior shelf height is adjustable.

Required opening in furnishing top is lift shelf size (width and depth) + 1/2". Includes single wall switch (MS-3R). See page 98 for other control options.

Weight limit is 150 lbs.

Travel Range	Part No.	PRICE	Interior Camera Shelf Dimensions	Shipping Wt./lbs.	Freight Class
10"	300400	\$3611	10" H x 9" W x 7 1/2" D	30	85 P
10"	300402	3611	10" H x 12" W x 9" D	42	150 P

\*Custom sizes are also available. Please call Draper for additional information and pricing.

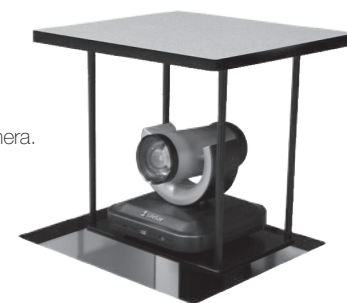

## Video Conferencing Camera Adapter Bracket

The Video Conferencing Camera Adapter Bracket enables the installation of the video conferencing camera of your choice into three of Draper's most popular video projector lifts (AeroLift 35, AeroLift 100, or Micro Projector Lift). All are designed to safely conceal your camera above the ceiling line when not in use and lower it into position for video conferencing. Available in two sizes. Special brackets available for oversize or dual camera installation. Contact Draper for quotation.

Dimensions (H x W x D)	Part No.	PRICE
7 1/2" x 9" x 7 1/2"	125205	\$408
9" x 12" x 9"	125206	408

\*Due to the smaller footprint of most video conferencing cameras, a smaller ceiling closure panel may be desired. Custom ceiling closures are available. Please call Draper for additional information and pricing or see page 96 for Aerolift Video Conferencing Camera Shelf and Closure.

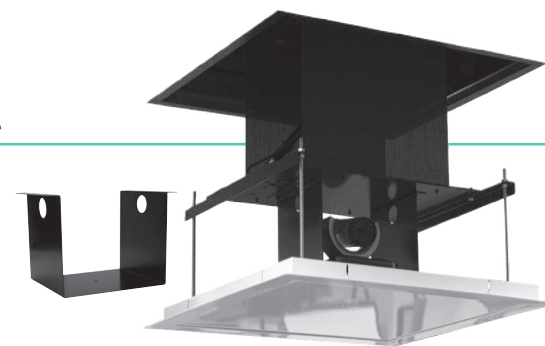

# Lift Control Options

AeroLift / LCD Lift / Micro Projector Lift	Model Number	Part Number	PRICE
<b>110-120V Controls</b>			
Replacement single station wall switch (Black/Silver)	SS-1R (Standard)	121001	\$72
Replacement single station wall switch (White decorator style)	SS-1R (White)	121102	75
<b>Low Voltage Control (24v)</b>			
Low-Voltage control module, no switches	LVC-IV	121222	\$248
Single station, Low-Voltage control combo	LVC-IV & LVC-S	121223	298
2-station Low-Voltage control combo	LVC-IV & 2 LVC-S	121224	347
Additional Low-Voltage control stations	LVC-S	121225	70
LVC-S with locking cover plate		121232	150
RF Wireless Transmitter	WRT	121226	80
*Infrared Remote Transmitter/Receiver	IRT/R	121227	98
Extra IR Remote Transmitter	IRT	121228	80
Low-Voltage control with RF Wireless Transmitter	LVC-IV/WRT Kit	121233	347
Low-Voltage control with IR Remote Transmitter	LVC-IV/IRT Kit	121234	347

You must have the LVC-IV control if you are using a master control system requiring contact closure.

Revelation does not require a Lift Low-Voltage Control to interface with a Crestron/AMX/Extron master control system.

<b>Key Operated Switches</b>			
Power supply switch (on-off)	KS-1	121017	\$98
3-position (up-off-down) key control switch (maintained)	KS-3	121018	110
3-position (up-off-down) key control switch (momentary)	SP-KSM	121022	110
Switch with locking cover plate	SP-KPS-I	121019	130

## Scissor Lift (SL and SLX)

	Model Number	Part Number	PRICE
<b>Single Station Controls</b>			
Standard: 12V toggle switch to lower projector from "stored" to "show" positions, and 1 momentary key switch which allows you to easily place the lift in the service position.			
Additional Low-Voltage control stations	Low-Voltage Control Station	121246	\$70
Replacement Key Switch for Service Position	SP-KSM	121022	110
<b>Wireless Control (24v)</b>			
IR Kit (Transmitter/Receiver)	IRT/R	121251	\$100
Extra IR Remote Transmitter	IRT	121250	80
<b>Scissor Lift Serial Controls</b>			
R2D7-RS232 Translator (converts ASCII commands into Draper controller commands)		C156.066	\$215
Serial Port Adapter (converts 9 pin serial port to an RJ11 modular phone cable)		C103.042	20

Information and prices subject to change without notice.

LVC-IV



LVC-S



WRT



IRT



KS-1



KS-3



SP-KPS-I

### Freight Class Key

**Number** LTL freight class  
**P** . . . . . Parcel Service  
**+** . . . . . \$15 surcharge  
 (over 48" long)

**Example:** a freight code of 125 P+ indicates an item that may ship as freight class 125 or via parcel service with \$15 surcharge.

# Video Conferencing Backgrounds

## Three Styles of Custom Backgrounds for Every Need

### Digital Printed Backgrounds

No matter the message or the artwork Draper Printed Backgrounds offer unlimited potential to enhance your signage and make it more effective.

Custom graphics are available on select Draper motorized, manual, or even portable projection screen models. These screens can proudly display your logo in boardrooms for video conferencing backgrounds. Portable models are ideal for trade show signage, point-of-purchase advertising, or even as mobile video conferencing backgrounds.



### In-House Graphic Printing

*Put virtually any company logo, graphic, or photograph on your background.*

You provide the artwork, and we'll print your logo or graphic. Graphics can be printed on either side of the background. Please see your Draper representative for restrictions and availability.

We use a high quality, digital four-color process to assure a crisp and clear image. Order for graphics must accompany order. Contact Draper for details and pricing.

*Here's what to expect when ordering:*

#### Your prints will look better than ever

Our in-house equipment produces the most bright, vivid colors that we've ever offered, with a wide color gamut and sharp detail.

#### Breathe in the clean air

There are no VOCs or off-gassing from our latex inks, which are GREENGUARD Gold Certified.

#### You'll receive your order promptly

Due to improved control over speed and turnaround times for printed products.

#### Your product will last

Our latex inks resist light-fading for many years. They also have a high resistance to damage from scratching, abrasion, water, and chemicals.

### Preparation For Printing on a Video Conferencing Background

#### PREFERRED FILE FORMATS FOR GRAPHIC ART:

**Adobe Illustrator or EPS (Encapsulated PostScript).** Illustrations should be vector-based (not simply a PhotoShop file saved as an EPS). All typography should be converted to paths (outlines).

**Other Accepted Format: (Tagged Image File) TIF** TIF should be flattened (no layers), CMYK color mode, at 150dpi (dots per inch).

#### Image Size:

All files should be sized exactly to the final print size. For example, if your shade's visible area is 50" x 50" in size, your graphic image size should be 50" x 50".

#### Bleed:

If the graphic is to bleed (if the image is to run all the way to the edge of the shade), add 1/2" to all sides of the image size for bleed to allow for trimming.

### Neutral Backgrounds

Eliminate distractions for your camera and your viewers with soothing neutral backgrounds in seven muted earth tones (**Canvas, Chalk, Charcoal, Khaki, Linen, Marine, and Pewter**). Prevent unwanted interference, control room lighting, and ensure a consistent corporate image worldwide with a Draper Neutral Background. They are the perfect way to add the atmosphere of a dedicated video conferencing space to existing meeting rooms, offices, or anywhere you choose.



### Chroma Key Green Backgrounds

Many Draper projection screen models may be utilized as video production backgrounds with a Chroma Key Green surface.

Draper offers industry standard **Chroma Key Green** surfaces (commonly known as "green screen" surfaces) for use as video production or video conferencing backgrounds.

Would your video conferencing benefit from changing background images or even live action video footage? Draper's Chroma Key Green surfaces make it easy.



### Need Help Choosing your Motorized Background?

Model	Installation	Case Type	Width Range	Chroma Key Availability	Page
VCB Access E	Ceiling-Recessed	Steel	70"-14'	Yes	100
VCB Access XL E	Ceiling-Recessed	Steel	16'-20'	Yes	100
VCB Ultimate Access E	Ceiling-Recessed w/Closure	Steel	70"-12'	Yes	101
VCB Paragon	Ceiling-Recessed	Aluminum	20'-28'	Yes	103
VCB Targa	Wall/Ceiling Mounted	Steel	70"-144"	Yes	102
VCB Targa XL	Wall/Ceiling Mounted	Aluminum	12'-16'	Yes	102
VCB Silhouette E	Wall/Ceiling Mounted	Aluminum	70"-8'	Yes	101
VCB Access Dual Roller	Ceiling-Recessed	Steel	70"-12'	Yes	104

*Please Note: Discounts are available for multiple backgrounds. Please call for details.*

VIDEO CONFERENCING BACKGROUNDS

# Motorized Backgrounds

Draper Motorized Backgrounds offer the ultimate in convenience. No matter how you would like it installed, Draper makes it easy to raise or lower your background with the touch of a remote or wall switch. Other models not shown available by quotation. Standard sizes shown below. Please call for quotation on other (custom) sizes. For Motor and Control Options, see pages 35-36.

## VCB Access E Backgrounds

Sleek white folded steel case installs above ceiling. Trim flange finishes the ceiling opening. Standard background sizes from 96" h. x 70" w. to 144" h. x 144" w. Custom sizes up to 192" wide available by quotation. Includes one 110-120v 3-position switch.

### \*\*NEUTRAL Backgrounds -

Add color suffix to end of part number when ordering.

Available in seven colors. Add color suffix to end of part number when ordering (Canvas-**CA**, Chalk-**CW**, Charcoal-**CC**, Khaki-**KH**, Linen-**LI**, Marine-**MW**, Pewter-**PP**). Also available in black or grey by special quotation.

### \* DIGITAL PRINTED Backgrounds

Customized with the graphic you provide. Setup fee and per square foot fee in addition to cost of selected background from tables below.

See page 99 for additional details and instructions.

H x W	Chroma Key Green	**Neutral Background	PRICE	*Digital Printed	Shipping Wt./lbs.	Freight Class
96" x 70"	V13901KG	V13901**	\$2851	V13901PR	70	125
108" x 70"	V13902KG	V13902**	2874	V13902PR	71	125
120" x 70"	V13903KG	V13903**	2897	V13903PR	72	125
132" x 70"	V13904KG	V13904**	2921	V13904PR	73	125
144" x 70"	V13905KG	V13905**	2946	V13905PR	74	125
96" x 84"	V13906KG	V13906**	2899	V13906PR	83	125
108" x 84"	V13907KG	V13907**	2927	V13907PR	84	125
120" x 84"	V13908KG	V13908**	2957	V13908PR	85	125
132" x 84"	V13909KG	V13909**	2984	V13909PR	86	125
144" x 84"	V13910KG	V13910**	3012	V13910PR	87	125
96" x 96"	V13911KG	V13911**	2954	V13911PR	87	125
108" x 96"	V13912KG	V13912**	2984	V13912PR	88	125
120" x 96"	V13913KG	V13913**	3016	V13913PR	89	125
132" x 96"	V13914KG	V13914**	3049	V13914PR	90	125
144" x 96"	V13915KG	V13915**	3079	V13915PR	91	125
96" x 108"	V13916KG	V13916**	3039	V13916PR	96	125
108" x 108"	V13917KG	V13917**	3076	V13917PR	97	125
120" x 108"	V13918KG	V13918**	3111	V13918PR	98	125
132" x 108"	V13919KG	V13919**	3149	V13919PR	99	125
144" x 108"	V13920KG	V13920**	3186	V13920PR	100	125
96" x 120"	V13921KG	V13921**	3116	V13921PR	98	125
108" x 120"	V13922KG	V13922**	3146	V13922PR	99	125
120" x 120"	V13923KG	V13923**	3172	V13923PR	100	125
132" x 120"	V13924KG	V13924**	3211	V13924PR	101	125
144" x 120"	V13925KG	V13925**	3256	V13925PR	102	125
96" x 144"	V13926KG	V13926**	3211	V13926PR	122	125
108" x 144"	V13927KG	V13927**	3269	V13927PR	125	125
120" x 144"	V13928KG	V13928**	3359	V13928PR	130	125
132" x 144"	V13929KG	V13929**	3452	V13929PR	137	125
144" x 144"	V13930KG	V13930**	3544	V13930PR	141	125

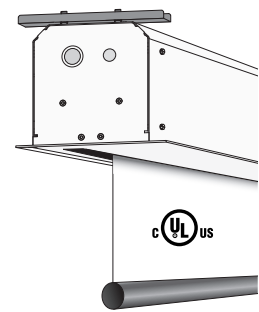

## VCB Access XL E Backgrounds

The VCB Access XL E line of video conferencing backgrounds are motorized, ceiling-recessed, and offer the same great features as other Access backgrounds—now in a range of large sizes. Includes one 110-120v 3-position switch.

H x W	Chroma Key Green	**Neutral Background	PRICE	*Digital Printed	Shipping Wt./lbs.	Freight Class
8' x 16'	V14605KG	V14605**	\$9772	V14605PR	582	125
8' x 18'	V14610KG	V14610**	9820	V14610PR	712	125
8' x 20'	V14616KG	V14616**	9862	V14616PR	718	125
10' x 16'	V14606KG	V14606**	9884	V14606PR	585	125
10' x 18'	V14611KG	V14611**	9907	V14611PR	715	125
10' x 20'	V14617KG	V14617**	10412	V14617PR	721	125
12' x 16'	V14607KG	V14607**	10449	V14607PR	588	125
12' x 18'	V14612KG	V14612**	10489	V14612PR	718	125
12' x 20'	V14618KG	V14618**	10520	V14618PR	724	125
14' x 16'	V14608KG	V14608**	10537	V14608PR	591	125
14' x 18'	V14613KG	V14613**	10552	V14613PR	721	125
14' x 20'	V14619KG	V14619**	10862	V14619PR	727	125
16' x 16'	V14609KG	V14609**	11036	V14609PR	594	125
16' x 18'	V14614KG	V14614**	11234	V14614PR	724	125
16' x 20'	V14620KG	V14620**	11439	V14620PR	730	125
18' x 18'	V14615KG	V14615**	11649	V14615PR	727	125
18' x 20'	V14621KG	V14621**	11754	V14621PR	733	125
20' x 20'	V14622KG	V14622**	11901	V14622PR	736	125

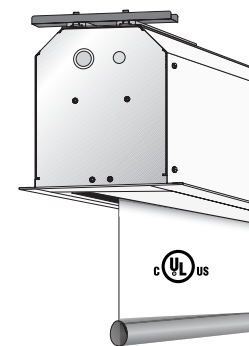

# Motorized Backgrounds

## VCB Ultimate Access E Backgrounds

Ceiling-recessed background with an independently motorized ceiling closure. When the background is retracted, the motorized closure forms a solid bottom panel giving the ceiling a clean appearance. Background sizes from 96" h. x 70" w. to 144" h. x 144" w. Includes one 110V-120V 3-position switch.

### \*\*NEUTRAL Backgrounds -

Add color suffix to end of part number when ordering.

Available in seven colors. Add color suffix to end of part number when ordering (Canvas-**CA**, Chalk-**CW**, Charcoal-**CC**, Khaki-**KH**, Linen-**LI**, Marine-**MW**, Pewter-**PP**). Also available in black or grey by special quotation.

### \* DIGITAL PRINTED Backgrounds

Customized with the graphic you provide. Setup fee and per square foot fee in addition to cost of selected background from tables below.

See page 99 for additional details and instructions.

H x W	Chroma Key Green	**Neutral Background	PRICE	*Digital Printed	Shipping Wt./lbs.	Freight Class
96" x 70"	V14201KG	V14201**	\$4278	V14201PR	98	125
108" x 70"	V14202KG	V14202**	4301	V14202PR	99	125
120" x 70"	V14203KG	V14203**	4326	V14203PR	100	125
132" x 70"	V14204KG	V14204**	4351	V14204PR	101	125
144" x 70"	V14205KG	V14205**	4371	V14205PR	102	125
96" x 84"	V14206KG	V14206**	4371	V14206PR	120	125
108" x 84"	V14207KG	V14207**	4401	V14207PR	121	125
120" x 84"	V14208KG	V14208**	4429	V14208PR	122	125
132" x 84"	V14209KG	V14209**	4458	V14209PR	123	125
144" x 84"	V14210KG	V14210**	4488	V14210PR	124	125
96" x 96"	V14211KG	V14211**	4441	V14211PR	147	125
108" x 96"	V14212KG	V14212**	4471	V14212PR	148	125
120" x 96"	V14213KG	V14213**	4504	V14213PR	149	125
132" x 96"	V14214KG	V14214**	4536	V14214PR	150	125
144" x 96"	V14215KG	V14215**	4569	V14215PR	151	125
96" x 108"	V14216KG	V14216**	4559	V14216PR	152	125
108" x 108"	V14217KG	V14217**	4596	V14217PR	153	125
120" x 108"	V14218KG	V14218**	4633	V14218PR	154	125
132" x 108"	V14219KG	V14219**	4671	V14219PR	155	125
144" x 108"	V14220KG	V14220**	4703	V14220PR	156	125
96" x 120"	V14221KG	V14221**	4683	V14221PR	161	125
108" x 120"	V14222KG	V14222**	4718	V14222PR	162	125
120" x 120"	V14223KG	V14223**	4756	V14223PR	163	125
132" x 120"	V14224KG	V14224**	4799	V14224PR	164	125
144" x 120"	V14225KG	V14225**	4838	V14225PR	165	125
96" x 144"	V14226KG	V14226**	4728	V14226PR	182	125
108" x 144"	V14227KG	V14227**	4776	V14227PR	183	125
120" x 144"	V14228KG	V14228**	4829	V14228PR	184	125
132" x 144"	V14229KG	V14229**	4883	V14229PR	185	125
144" x 144"	V14230KG	V14230**	4933	V14230PR	186	125



## VCB Silhouette E Backgrounds

Sleek, curved aluminum case and endcaps are finished in white. Slender dimensions and contemporary design. Background sizes from 70" h. x 70" w. to 96" h. x 96" w. Includes one 110V-120V 3-position switch.

H x W	Chroma Key Green	Neutral Background	PRICE	Digital Printed	Shipping Wt./lbs.	Freight Class
70" x 70"	V10801KG	V10801**	\$1549	V10801PR	45	125 P
84" x 70"	V10802KG	V10802**	1570	V10802PR	46	125 P
96" x 70"	V10803KG	V10803**	1595	V10803PR	47	125 P
70" x 84"	V10804KG	V10804**	1635	V10804PR	57	125 P
84" x 84"	V10805KG	V10805**	1662	V10805PR	58	125 P
96" x 84"	V10806KG	V10806**	1690	V10806PR	59	125 P
70" x 96"	V10807KG	V10807**	1704	V10807PR	61	125 P
84" x 96"	V10808KG	V10808**	1737	V10808PR	65	125 P
96" x 96"	V10809KG	V10809**	1769	V10809PR	72	125 P



# Motorized Backgrounds

Draper Motorized Backgrounds offer the ultimate in convenience. No matter how you would like it installed, Draper makes it easy to raise or lower your background with the touch of a remote or wall switch. Other models not shown available by quotation. Standard sizes shown below. Please call for quotation on other (custom) sizes. Includes one 110V-120V 3-position switch. *For Motor and Control Options, see pages 35-36.*

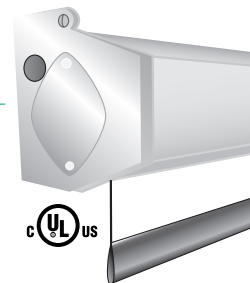

## VCB Targa Backgrounds

Pentagonal steel case is scratch-resistant white polyester finish with matching endcaps. Background sizes from 96" h. x 70" w. to 144" h. x 144" w. *For Motor and Control Options, see pages 35-36.*

H x W	Chroma Key Green	**Neutral Background	PRICE	*Digital Printed	Shipping Wt./lbs.	Freight Class
96" x 70"	V11601KG	V11601**	\$1374	V11601PR	52	125
108" x 70"	V11602KG	V11602**	1397	V11602PR	53	125
120" x 70"	V11603KG	V11603**	1419	V11603PR	54	125
132" x 70"	V11604KG	V11604**	1447	V11604PR	55	125
144" x 70"	V11605KG	V11605**	1470	V11605PR	56	125
96" x 84"	V11606KG	V11606**	1452	V11606PR	54	125
108" x 84"	V11607KG	V11607**	1479	V11607PR	55	125
120" x 84"	V11608KG	V11608**	1502	V11608PR	56	125
132" x 84"	V11609KG	V11609**	1535	V11609PR	57	125
144" x 84"	V11610KG	V11610**	1562	V11610PR	58	125
96" x 96"	V11611KG	V11611**	1507	V11611PR	66	125
108" x 96"	V11612KG	V11612**	1542	V11612PR	67	125
120" x 96"	V11613KG	V11613**	1570	V11613PR	67	125
132" x 96"	V11614KG	V11614**	1604	V11614PR	69	125
144" x 96"	V11615KG	V11615**	1637	V11615PR	70	125
96" x 108"	V11616KG	V11616**	1647	V11616PR	70	125
108" x 108"	V11617KG	V11617**	1680	V11617PR	71	125
120" x 108"	V11618KG	V11618**	1717	V11618PR	72	125
132" x 108"	V11619KG	V11619**	1752	V11619PR	73	125
144" x 108"	V11620KG	V11620**	1789	V11620PR	74	125
96" x 120"	V11621KG	V11621**	1662	V11621PR	74	125
108" x 120"	V11622KG	V11622**	1732	V11622PR	75	125
120" x 120"	V11623KG	V11623**	1799	V11623PR	76	125
132" x 120"	V11624KG	V11624**	1840	V11624PR	77	125
144" x 120"	V11625KG	V11625**	1880	V11625PR	78	125
96" x 144"	V11626KG	V11626**	2005	V11626PR	95	125
108" x 144"	V11627KG	V11627**	2094	V11627PR	96	125
120" x 144"	V11628KG	V11628**	2325	V11628PR	97	125
132" x 144"	V11629KG	V11629**	2544	V11629PR	98	125
144" x 144"	V11630KG	V11630**	2674	V11630PR	99	125

**\*\*NEUTRAL Backgrounds -**  
**Add color suffix to end of part number when ordering.** Available in seven colors. Add color suffix to end of part number when ordering (Canvas-**CA**, Chalk-**CW**, Charcoal-**CC**, Khaki-**KH**, Linen-**LI**, Marine-**MW**, Pewter-**PP**). Also available in black or grey by special quotation.

**\* DIGITAL PRINTED Backgrounds**  
 Customized with the graphic you provide. Setup fee and per square foot fee in addition to cost of selected background from tables below.  
*See page 99 for additional details and instructions.*

## VCB Targa XL Backgrounds

Steel case is scratch-resistant white polyester finish with matching endcaps. Background sizes up to 16' h. x 16' w. *For Motor and Control Options, see pages 35-36.* Includes one 110V-120V 3-position switch.

**Extruded aluminum, 6 3/4" x 6 3/4". Targa XL cases are not compatible with 6" extension brackets, Ceiling Opening Trim Kit, or optional Q and QL motors.**

H x W	Chroma Key Green	**Neutral Background	PRICE	*Digital Printed	Shipping Wt./lbs.	Freight Class
8' x 14'	V11631KG	V11631**	\$3386	V11631PR	300	125
9' x 14'	V11632KG	V11632**	3514	V11632PR	303	125
10' x 14'	V11633KG	V11633**	3609	V11633PR	306	125
11' x 14'	V11634KG	V11634**	3707	V11634PR	309	125
12' x 14'	V11635KG	V11635**	3791	V11635PR	312	125
14' x 14'	V11636KG	V11636**	3907	V11636PR	315	125
8' x 16'	V11637KG	V11637**	4079	V11637PR	305	125
9' x 16'	V11638KG	V11638**	4188	V11638PR	308	125
10' x 16'	V11639KG	V11639**	4266	V11639PR	311	125
11' x 16'	V11640KG	V11640**	4368	V11640PR	298	125
12' x 16'	V11641KG	V11641**	4409	V11641PR	301	125
14' x 16'	V11642KG	V11642**	4509	V11642PR	304	125
16' x 16'	V11643KG	V11643**	4618	V11643PR	307	125

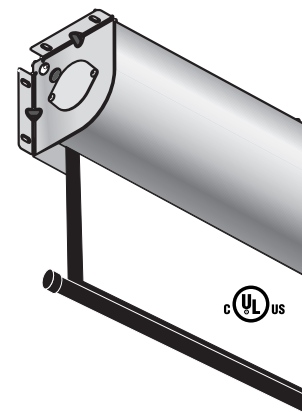

# Motorized Backgrounds

## VCB Paragon E Backgrounds

This large ceiling-recessed background features a white extruded aluminum case. Operates on a 6" steel roller powered by an extremely strong tubular motor-in-roller. Case measures 13 1/4" H x 12" D. Includes one 110V-120V 3-position switch.

### \*\*NEUTRAL Backgrounds -

Add color suffix to end of part number when ordering.

Available in seven colors. Add color suffix to end of part number when ordering (Canvas-**CA**, Chalk-**CW**, Charcoal-**CC**, Khaki-**KH**, Linen-**LI**, Marine-**MW**, Pewter-**PP**). Also available in black or grey by special quotation.

### \* DIGITAL PRINTED Backgrounds

Customized with the graphic you provide. Setup fee and per square foot fee in addition to cost of selected background from tables below. See page 99 for additional details and instructions.

H x W	Chroma Key Green	**Neutral Background	PRICE	*Digital Printed	Shipping Wt./lbs.	Freight Class
10' x 20'	V11401KG	V11401**	\$6226	V11401PR	785	125
12' x 20'	V11402KG	V11402**	6430	V11402PR	790	125
14' x 20'	V11403KG	V11403**	6631	V11403PR	794	125
16' x 20'	V11404KG	V11404**	6833	V11404PR	800	125
18' x 20'	V11405KG	V11405**	7035	V11405PR	802	125
20' x 20'	V11406KG	V11406**	7238	V11406PR	805	125
10' x 22'	V11407KG	V11407**	6723	V11407PR	835	125
12' x 22'	V11408KG	V11408**	6841	V11408PR	840	125
14' x 22'	V11409KG	V11409**	7016	V11409PR	844	125
16' x 22'	V11410KG	V11410**	7070	V11410PR	850	125
18' x 22'	V11411KG	V11411**	7426	V11411PR	852	125
20' x 22'	V11412KG	V11412**	7783	V11412PR	855	125
10' x 24'	V11413KG	V11413**	7295	V11413PR	885	125
12' x 24'	V11414KG	V11414**	7573	V11414PR	890	125
14' x 24'	V11415KG	V11415**	8242	V11415PR	894	125
16' x 24'	V11416KG	V11416**	8903	V11416PR	900	125
18' x 24'	V11417KG	V11417**	9564	V11417PR	902	125
20' x 24'	V11418KG	V11418**	10229	V11418PR	905	125
10' x 26'	V11419KG	V11419**	13873	V11419PR	935	125
12' x 26'	V11420KG	V11420**	15215	V11420PR	940	125
14' x 26'	V11421KG	V11421**	16550	V11421PR	944	125
16' x 26'	V11422KG	V11422**	18454	V11422PR	950	125
18' x 26'	V11423KG	V11423**	20351	V11423PR	952	125
20' x 26'	V11424KG	V11424**	22246	V11424PR	955	125
10' x 28'	V11425KG	V11425**	19282	V11425PR	985	125
12' x 28'	V11426KG	V11426**	19522	V11426PR	990	125
14' x 28'	V11427KG	V11427**	20863	V11427PR	994	125
16' x 28'	V11428KG	V11428**	22189	V11428PR	1000	125
18' x 28'	V11429KG	V11429**	23526	V11429PR	1002	125
20' x 28'	V11430KG	V11430**	24865	V11430PR	1005	125

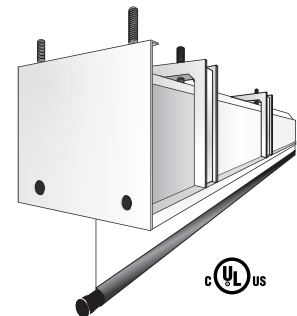

To find the minimum screen size for your Video Conferencing setup please visit our calculator at <http://www.draperinc.com/videoconferencing/vcbwidth.aspx>

### Freight Class Key

**Number** LTL freight class  
**P** . . . . . Parcel Service  
**+** . . . . . \$15 surcharge (over 48" long)

**Example:** a freight code of 125 P+ indicates an item that may ship as freight class 125 or via parcel service with \$15 surcharge.

# Dual Roller Motorized Backgrounds

Take the convenience of a quality motorized background from Draper to the next level with a Dual Roller Background featuring two motorized panels in a single housing. Choose from two of Draper's three background materials or even two printed surfaces that serve differing audiences. Display your location in "multiple site" video conferences. All prices below are for Neutral colors or Chroma Key Green.



Dual Roller Background (Ceiling Recessed, Printed)



Dual Roller Background (Ceiling Recessed, Neutral)

## VCB Dual Roller/Ceiling Recessed Video Conferencing Headbox

The perfect solution for concealing two panels where recessed ceiling installation is preferred, positioning the case bottom flush with the ceiling line. Enjoy simple operation for both panels, changing quickly and easily between them to suit your audience and your message. Remote control operation available. Background sizes from 8' h. x 70" w. to 11' h. x 11' w. Standard sizes shown below. Product does not include a factory installed ceiling closure, allowing you to customize your look in the field. Includes two 110V-120V 3-position switches.

For Motor and Control Options, see pages 35-36.

Call for quotation on other (custom) sizes.

Large Dual Roller Screen with Pocket Headbox - Dimensions Motorized Only

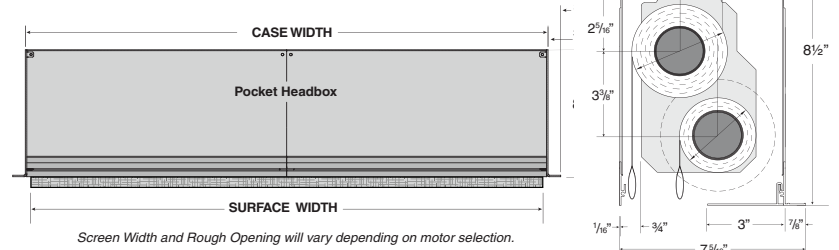

## Dual Roller Recessed Headbox Sizes

70" WIDTH	7' WIDTH	8' WIDTH	9' WIDTH	10' WIDTH	11' WIDTH
PRICE	PRICE	PRICE	PRICE	PRICE	PRICE
\$606	\$672	\$744	\$814	\$879	\$1017

### \* DIGITAL PRINTED Backgrounds

Customized with the graphic you provide. Setup fee and per square foot fee in addition to cost of selected background from tables below.

### How to order a VCB Dual Roller

First, just find the price to the left, then add two matching sized backgrounds from the table below. If one or both of the backgrounds will be printed, calculate the digital printing fee and add it to the total.

### Example pricing for 144" h x 120" w

	PRICE
10' w Ceiling Recessed Headbox	\$879
12' h x 10' w Neutral Marine	\$2,604
12' h x 10' w Chroma Key Green	\$2,604
TOTAL: \$879 + 2604 + 2604 =	\$6,087

## Dual Roller Background Sizes

	70" WIDTH	7' WIDTH	8' WIDTH	9' WIDTH	10' WIDTH	11' WIDTH
HEIGHT	PRICE	PRICE	PRICE	PRICE	PRICE	PRICE
8' Height	\$2201	\$2248	\$2303	\$2388	\$2466	\$2513
9' Height	2223	2276	2333	2426	2494	2549
10' Height	2209	2306	2364	2459	2523	2588
11' Height	2269	2333	2399	2498	2559	2613
12' Height	2296	2361	2429	2536	2604	2669



# Spring Roller Operated Backgrounds

Add a dynamic background to your video conferences for more compelling communications with this cost effective, low profile and simple to operate solution. Draper Spring Roller Operated Backgrounds can be mounted almost anywhere (wall, ceiling and ceiling recessed), pulled down at a moment's notice and take the professional impact of your message to the next level. Background sizes from 70" h. x 70" w. to 144" h. x 144" w., dependent on case style.

**Standard sizes shown below. Call for quotation on other (custom) sizes.**

**\* DIGITAL PRINTED Backgrounds**

Customized with the graphic you provide. Setup fee and per square foot fee in addition to cost of selected background from tables below. See page 99 for additional details and instructions.

## VCB Luma 2 Backgrounds

VCB Luma 2 is a heavy-duty wall or ceiling mounted background housed in a steel case which has a scratch-resistant white polyester finish with matching endcaps. Sizes to 144" h. x 144" w.

H x W	Chroma Key Green	PRICE	Digital Printed	Shipping Wt./lbs.	Freight Class
96" x 70"	V20601KG	\$810	V20601PR	37	85
108" x 70"	V20602KG	837	V20602PR	38	85
120" x 70"	V20603KG	867	V20603PR	39	85
132" x 70"	V20604KG	894	V20604PR	40	85
144" x 70"	V20605KG	919	V20605PR	41	85
96" x 84"	V20606KG	813	V20606PR	43	85
108" x 84"	V20607KG	849	V20607PR	44	85
120" x 84"	V20608KG	879	V20608PR	45	85
132" x 84"	V20609KG	909	V20609PR	46	85
144" x 84"	V20610KG	940	V20610PR	47	85
96" x 96"	V20611KG	875	V20611PR	47	85
108" x 96"	V20612KG	909	V20612PR	48	85
120" x 96"	V20613KG	947	V20613PR	49	85
132" x 96"	V20614KG	982	V20614PR	50	85
144" x 96"	V20615KG	1020	V20615PR	51	85
96" x 108"	V20616KG	1135	V20616PR	53	85
108" x 108"	V20617KG	1172	V20617PR	54	85
120" x 108"	V20618KG	1217	V20618PR	55	85
132" x 108"	V20619KG	1255	V20619PR	56	85
144" x 108"	V20620KG	1299	V20620PR	57	85
96" x 120"	V20621KG	1197	V20621PR	61	85
108" x 120"	V20622KG	1247	V20622PR	62	85
120" x 120"	V20623KG	1304	V20623PR	63	85
132" x 120"	V20624KG	1347	V20624PR	64	85
144" x 120"	V20625KG	1390	V20625PR	65	85
96" x 144"	V20626KG	1395	V20626PR	93	85
108" x 144"	V20627KG	1409	V20627PR	94	85
120" x 144"	V20628KG	1419	V20628PR	95	85
132" x 144"	V20629KG	1425	V20629PR	96	85
144" x 144"	V20630KG	1435	V20630PR	97	85

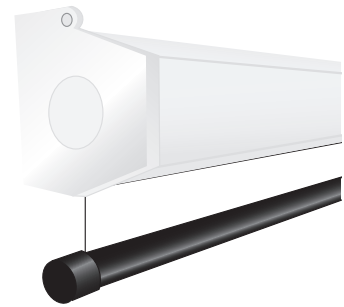

## VCB Silhouette M Backgrounds

VCB Silhouette M Backgrounds feature a sleek, curved aluminum case and endcaps finished in white. Slender dimensions and contemporary design. Sizes to 96" h. x 96" w.

H x W	Chroma Key Green	PRICE	Digital Printed	Shipping Wt./lbs.	Freight Class
70" x 70"	V20201KG	\$820	V20201PR	38	85 P
84" x 70"	V20202KG	847	V20202PR	39	85 P
96" x 70"	V20203KG	870	V20203PR	40	85 P
70" x 84"	V20204KG	825	V20204PR	42	85 P
84" x 84"	V20205KG	855	V20205PR	43	85 P
96" x 84"	V20206KG	884	V20206PR	44	85 P
70" x 96"	V20207KG	865	V20207PR	47	85 P
84" x 96"	V20208KG	902	V20208PR	48	85 P
96" x 96"	V20209KG	932	V20209PR	49	85 P



# Portable Backgrounds

Draper Portable Backgrounds can be set up in seconds on the floor or table. Light-weight and spring-roller operated, these portable backgrounds are a perfect solution for those on the go. Don't compromise the impact of your message just because you're in the office, on the road, or even at a tradeshow.

**Backgrounds listed below are representative sizes. A wide range of custom sizes are available. Call Draper for details.**

## Chroma Key Backgrounds

Need to change the backgrounds behind your still or video images? Draper's Chroma Key Backgrounds, typically referred to as or "green screen" technology, make it easy. With Draper's Chroma Key Backgrounds your backgrounds will never be static or lifeless again.

### \*\*NEUTRAL Backgrounds -

**Add color suffix to end of part number when ordering.**

Available in seven colors. Add color suffix to end of part number when ordering (Canvas-**CA**, Chalk-**CW**, Charcoal-**CC**, Khaki-**KH**, Linen-**LI**, Marine-**MW**, Pewter-**PP**). Also available in black or grey by special quotation.



Traveller Portable Background (Printed)

### \* DIGITAL PRINTED Backgrounds

Customized with the graphic you provide. Setup fee and per square foot fee in addition to cost of selected background from tables below.  
See page 99 for additional details and instructions.

## VCB Traveller Portable Background

Setup and video conference anywhere while maintaining the strength of your message with the VCB Traveller Portable Background! The increasingly mobile nature of video conferencing dictates that your background be mobile as well. It's the perfect neutral, printed or chroma key background solution in a durable streamlined case that's perfectly portable.

H x W	Chroma Key Green	Neutral Background	PRICE	Digital Printed	Shipping Wt./ lbs.	Freight Class
92 1/2" x 59 1/2"	V23003KG	V23003**	\$777	V23003PR*	22	85 P
92 1/2" x 65 1/2"	V23004KG	V23004**	810	V23004PR*	23	85 P
92 1/2" x 81 1/2"	V23005KG	V23005**	912	V23005PR*	24	85 P

### Freight Class Key

**Number** LTL freight class  
**P** . . . . . Parcel Service  
**+** . . . . . \$15 surcharge  
 (over 48" long)

**Example:** a freight code of 125 P+ indicates an item that may ship as freight class 125 or via parcel service with \$15 surcharge.

# AV Regional Sales Contacts

Region	Regional Sales Manager	Audio Visual Sales Consultant
<b>Canada</b>	<b>Draper Canada</b> 888-294-9889 orders@draperinc.ca	<b>Todd Hiday</b> Direct: 765.856.1264 thiday@draperinc.com
<b>DC, DE, FL, GA, MD, NC, SC, VA, W.VA</b>	<b>David McLaughlin</b> Mobile: 678.727.8789 david.mclaughlin@draperinc.com	<b>Curt Huntley</b> Direct: 765.856.1260 chuntley@draperinc.com
<b>AK, AZ, CA, CO, HI, ID, MT, NV, OR, UT, WA, WY</b>	<b>Ken Hartling</b> Mobile: 415.423.7437 khartling@draperinc.com	<b>Kimberly McCormick, CTS</b> Direct: 765.856.1299 kmccormick@draperinc.com
<b>AL, AR, KS, LA, MO (Kansas City), MS, OK, TN, TX</b>		<b>Nate LaMar</b> Direct: 765.856.1269 nlamar@draperinc.com
<b>CT, MA, ME, NH, NJ, NY, PA, RI, VT</b>		<b>Tara Jacobi</b> Direct: 765.856.1314 tara.jacobi@draperinc.com
<b>IA, IL, IN, KY, MI, MN, MO, ND, NE, OH, SD, WI</b>	<b>Brian Kunz, LEED®AP, CTS</b> Mobile: 765.524.1440 bkunz@draperinc.com	<b>Tyler C. Dungey</b> Direct: 765.856.1261 tyler.dungey@draperinc.com

Available 9am-6pm  
Eastern Standard  
Monday- Thursday.

## Telephone U.S. and Canada

### Call Toll Free

<b>PHONE</b>	<b>All Departments</b> 800.238.7999	<b>AV/VIDEO</b> 800.989.0112
<b>FAX</b>	<b>Orders</b> 866.637.5612	<b>Customer Service</b> 866.397.7353

<b>California Office</b>	<b>Hours:</b> 8:00 A.M.—5:00 P.M. Pacific Time	<b>Randy Reece -Western Region Manager, USA</b> Direct: 714.308.9343 rreece@draperinc.com
--------------------------	--	---

## Try our new Draper Pro App

### Exclusively for Draper dealers

Download the Draper Pro app and get your order status and much more right at your fingertips. Now available on Android, iOS, Windows, and Mac.

- Check your order status and track your shipments
- Keep up to date with the latest product information
- Get technical documents
- Find Draper contact information

## Getting started is easy - just follow these steps.

### Step 1:

Contact Draper at [DraperPro@Draperinc.com](mailto:DraperPro@Draperinc.com) to request access.

### Step 2:

Once you receive the reply, follow the included instructions to download the app and set your password.

### Step 3:

Use the app!

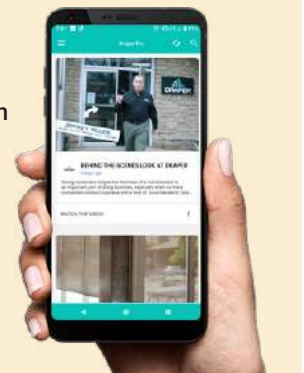

# AV Sales Contacts (CONTINUED)

## AV Market Managers

<b>Director of Audio Visual Markets</b>	<b>Bob Mathes</b> Direct: 765.856.1243 bmathes@draperinc.com
<b>Director Audio Visual Distribution</b>	<b>Jim Hoodlebrink</b> Direct: 765.856.1287 jhoodlebrink@draperinc.com
<b>Director of Sales</b>	<b>Jentry Wittkamper, CTS</b> Direct: 765.856.1248 jwittkamper@draperinc.com
<b>Audio Visual Sales Consultant Supervisor</b>	<b>Todd Hiday, CTS</b> Direct: 765.856.1264 thiday@draperinc.com
<b>Director of Business Development</b>	<b>Kevin Barlow</b> Direct: 678.591.4285 kevin.barlow@draperinc.com
<b>Director of Product Management</b>	<b>Grant Wylie</b> Direct: 765.591.7032 grant.wylie@draperinc.com

## AV Export

<b>Export Sales Consultants</b>	<b>Amy Howard</b> +1.765.987.7999 ext. 2308 ahoward@draperinc.com	<b>Monica Peavie</b> +1.765.987.7999 ext. 2341 mpeavie@draperinc.com
---------------------------------	---	--

## Custom Audiovisual Solutions

<b>Custom AV Solutions Project Manager</b>	<b>Heather Sipes</b> Direct: 765.856.1263 hsipes@draperinc.com
<b>Project Manager &amp; AVMS Product Coordinator</b>	<b>Cory Knight</b> Direct: 765.856.1234 cknight@draperinc.com

## Marketing

<b>Director of Marketing</b>	<b>Penny Sittler CDT, LEED® AP</b> Direct: 765.856.1221 psittler@draperinc.com	
<b>Image and Logo Requests</b>	<b>Mike Feeny</b> Direct: 765.856.1289 mfeeny@draperinc.com	<b>Sarah Scott</b> Direct: 765.856.1229 sarah.scott@draperinc.com
<b>Media Relations</b>	<b>Terry Coffey</b> Direct: 765.856.1230 Twitter: @DraperAV tcoffey@draperinc.com	

## AV Product Market Specialists

<b>Consultant Relations Manager</b>	<b>Steve Cook</b> 765.987.7999 ext 3113, Mobile: 781.733.7545 scook@draperinc.com	
<b>National Accounts</b>	<b>Monica Altman</b> Direct: 765.856.1252 monica.altman@draperinc.com	
<b>Audio Visual Project Sales Specialist</b>	<b>Diana Swim</b> Direct: 765.856.1265 dswim@draperinc.com	
<b>Audio Visual Project Sales Specialist</b>	<b>Carol Phelps</b> Direct: 765.856.1266 cphelps@draperinc.com	

## AV Technical Support Specialists

<b>Mark French</b> Direct: 765.856.1215 mark.french@draperinc.com	<b>Kimberly McCormick, CTS</b> Direct: 765.856.1299 kmcormick@draperinc.com	<b>Tara Jacobi</b> Direct: 765.856.1314 tara.jacobi@draperinc.com
---	---	---

## Special Assistance

<b>Accounts Receivable and Traffic Manager</b>	<b>Debbie Searcy</b> Direct: 765.856.1224 dsearcy@draperinc.com	
<b>Accounts Receivable</b>	<b>Amy Magee</b> Direct: 765.856.1256 amagee@draperinc.com	<b>Leonor New</b> Direct: 765.856.1209 lnew@draperinc.com
	<b>Cameron Hiner</b> Direct: 765.856.1254 cameron.hiner@draperinc.com	

## Customer Service

<b>Manager</b>		
<b>Beverly Ferguson</b>	ext. 1206	bferguson@draperinc.com
<b>Returns</b>		
<b>Mary Huffman</b>	ext. 1293	mary.huffman@draperinc.com
<b>Traffic Support</b>		
<b>Tina Loveless</b>	ext. 1213	tloveless@draperinc.com
<b>Order Status</b>		
<b>Ceci Houchins</b>	ext. 1336	ceci.houchins@draperinc.com
<b>Customer Service Support</b>		
<b>Carol McLemore</b>	ext. 1253	cmclmore@draperinc.com
<b>Kasey Ferguson</b>	ext. 1212	kasey.ferguson@draperinc.com
<b>Pam Chaney</b>	ext. 1269	pam.chaney@draperinc.com

# Part Number Prefix Key

101.....	Premier	202.....	Silhouette M
107.....	Silhouette V	206.....	Luma 2
108.....	Silhouette E	207.....	Luma
114.....	Paragon	211.....	Luma 2 R
115.....	Rolleramic	215.....	Diplomat R
116.....	Targa	218.....	Cinefold
120.....	Ultimate Access Cases	219.....	Cinefold Accessories
121.....	Electric Screen Controls	220.....	Cinefold Dress Kits
125.....	VCCB	221.....	Truss-Style Cinefold
132.....	Salara HW	222.....	Truss-Style Cinefold Dress Kits
136.....	Salara Plug & Play™	223.....	Pipe & Drape Runoffs
137.....	Salara M	227.....	Accessories for Manual Screens
138.....	Nocturne® E	230.....	Traveller and Piper
139.....	Access and Access FIT E	241.....	Ultimate Folding Screen
140.....	Access and Access FIT V	242.....	Ultimate Folding Screen Dress Kits
142.....	Ultimate Access E	251.....	Cineperm
143.....	Ultimate Access V	252.....	Clarion
144.....	Ultimate Access XL E	253.....	Onyx and ShadowBox Clarion
145.....	Ultimate Access XL V	254.....	Profile+
146.....	Access XL E	254.....	First Surface Mirrors/MiroClear
147.....	Access XL V	300.....	Projector and FlatScreen Lifts
150.....	Ropewalker	350.....	Easels
197.....	Access and Access FIT M	384.....	StageScreen®
200.....	Premier C and Nocturne® C	385.....	FocalPoint®
201.....	Silhouette C		

## Terms and Conditions

- Draper sells only to authorized Draper dealers under this price list. Possession of the price list does not necessarily constitute an offer to sell.
- All prices FOB factory unless otherwise specified. Prices and specifications subject to change without notice.
- **Orders are entered subject to Draper's terms. These terms may only be revised by a written agreement signed by a duly authorized representative of Draper, Inc. Any additional or different terms or conditions in the customer's order or confirmation are not accepted by Draper, Inc. Our invoice constitutes the final written expression of all terms of sale and is a complete and exclusive statement of those terms. Any and all representations, promises, warranties or statements made or given to customer that differ in any way from the terms of our written invoice shall be given no force or effect.**
- **Quotations:** Purchase orders received by Draper without a valid quotation number will be processed and invoiced at regular net prices. In the event you later produce a valid quotation number, a processing fee of 2% may be added to the invoice.
- **Phone orders:** We encourage you to place orders in writing. We make every attempt to fill verbal orders accurately, but we cannot guarantee mistakes resulting from verbal miscommunication will be resolved in your favor.
- **Payment terms:** 30 days net with approved credit. Payment by Visa, MasterCard and Discover Card accepted, with no surcharge. **Use our online payment portal at: [www.draperinc.com/pay](http://www.draperinc.com/pay).**
- **Change Policy:** Draper needs to receive any changes to orders within 24 hours. After that point, change fees may apply.
- **Return policy:** No product may be returned without a written Return Material Authorization. Returns are subject to a restocking charge (except warranty repairs), and must be shipped freight prepaid according to Draper's instructions.
- **Cancellation Policy:** Cancelled orders may result in cancellation charges. While we will make every effort to minimize such charges, once an order is entered for manufacture, its cancellation may result in charges for material, labor, shipping or restocking.
- **Warranty:** All products in this price list are warranted for one year against defects in materials and workmanship. Detailed warranty terms are available upon request.

## Draper Patent Information

Draper's engineering team is continually creating new and unique products and design improvements. Many of our innovations are covered by patents. You may see a list of patented products here: [draperinc.com/legal/patents/](http://draperinc.com/legal/patents/)

# Minimum Advertised Price (MAP) Policy—Effective June 1, 2016

This Policy applies to all Draper, Inc. ("Draper") projection screens and related equipment.

At Draper, we recognize that our distributors and authorized dealers are keys to our ability to successfully operate in a competitive environment where customers have a myriad of choices. It is necessary that we take steps to encourage our distributors and authorized dealers to invest time and resources to deliver an extraordinary customer experience through their knowledgeable staff and their compelling marketing and educational materials. Draper is committed to supporting its distributors and authorized dealers in their efforts to grow their businesses by promoting Draper-branded products.

To ensure profit margins for our distributors and authorized dealers that are commensurate with their investments, to protect the value of the Draper brand, and to maintain brand equity by emphasizing the value and quality of Draper's products through advertising and education, Draper, in its unilateral and sole determination, establishes this procompetitive Minimum Advertised Price Policy (MAP Policy) for the advertising and marketing of Draper products by distributors and authorized dealers. Draper is confident this MAP Policy will strengthen its competitiveness and benefit all of its distributors and authorized dealers.

This Policy applies only to advertised prices and does not apply to actual resale prices. Draper does not dictate the price at which a distributor or an authorized dealer sells Draper products, and they are free to sell products individually or bundled with other third party products or services at any price they choose.

Advertising a price lower than the MAP next to the featured MAP Product in any advertisement will be viewed as a violation of this MAP Policy. This MAP Policy applies to all advertisements of MAP Products in any and all media, including, without limitation, flyers, posters, coupons, mailers, inserts, newspapers, magazines catalogs, mail order catalogs, internet or similar electronic media including websites, forums, email newsletters, email solicitations, television, radio, and public signage. Such website features as "Click for price", automated "bounce – back" pricing e-mails, pre-formatted e-mail responses, forms, automatic price display for any items prior to being placed in a customer's shopping cart, and other similar features are considered to be communications initiated by the distributor or authorized dealer (rather than by the customer) and such communications that disclose or advertise prices below MAP constitute prohibited "advertising" under this MAP Policy.

It is not a violation of this MAP Policy for distributors and authorized dealers to direct their customers to call or email their customer service representatives regarding the MAP Product's price, so long as the price is not otherwise published. Distributors and authorized dealers may also make coupons or similar promotions available to customers after customers have added MAP Products to their online basket of goods.

Prices for Draper products that are below MAP may not appear in any online search tool (e.g., Google Shopper, Price Grabber, NextTag, etc.) where your website is linked as the source.

Note: Certain online sales strategies result in advertised pricing that is below MAP Policy pricing. In the case of "add to cart" or "click here to see our low price" strategies, for example; Google Checkout will advertise the last price paid. Therefore, when products are sold at prices below MAP Policy pricing, an advertising event occurs to the next consumer because they see the product and the "last price sold" without having to "add to cart." This inadvertent advertising is not permitted and must be monitored by the distributor or authorized dealer or risk violating the MAP Policy.

Prices with a "strike-thru" and a redirection to "Check-out Cart" to see a price that is below MAP Policy pricing is considered a violation of the MAP Policy. Advertising discounts on products prior to those products being added to an online basket is not permitted (e.g., distributors and authorized dealers cannot state "10% off Draper products when added to the cart").

## CURRENT MAP

Detailed MAP pricing is found in the Excel price list which is available for download in the Draper Pro Portal at [draperinc.com/draperpro](http://draperinc.com/draperpro).

MAP Policy pricing for all Draper projection screens with TecVision viewing surfaces is equal to MSRP. For all other products covered under this policy MAP Policy pricing is equal to MSRP less 20%. A complete MSRP list is attached hereto as Exhibit A.

Draper reserves in its unilateral discretion the right to use promotional prices from time to time that may or may not indicate the use of instant, mail-in, or online rebates. These promotional prices may be marketed by distributors and authorized dealers with strict adherence to guidance provided by Draper. This includes site-wide promotions such as "10% off on all items at checkout for a limited time." All inquiries regarding use of Draper promotional prices should be directed to Draper's Marketing Manager, Penny Sitler, at [psitler@draperinc.com](mailto:psitler@draperinc.com) or (765) 987-7999.

Finally, in order to further protect Draper's procompetitive business interests and strategy as outlined above, Draper in its sole discretion chooses to sell or distribute products only through distributors and authorized dealers that themselves impose MAP policies on their reseller customers. Draper reserves in its unilateral discretion the right to terminate its relationship with any distributor or authorized dealer that does not have a MAP policy for its resellers.

## ENFORCEMENT

This Policy is a unilateral statement of Draper's preference concerning the advertising practices of accounts to which Draper chooses to resell its products. It is not the purpose of this Policy to restrict, coerce, force or reach agreement with a customer to charge a particular price for any Draper product. The Policy is not a contract or an offer to form a contract, agreement or any other form of mutual understanding. Rather, the Policy describes the terms under which Draper may, in its sole discretion, choose to sell its products subject to the Policy; Draper does not ask for, and will not accept, any agreement to comply with this Policy.

Draper has a four strike policy on MAP violations. For the first and second violations, Draper will send written warnings to the offending party. For the third violation, the offending party will forfeit its business relationship with Draper for a period of 30 days. If the party violates the MAP policy a fourth time, Draper will suspend the party's business relationship with Draper indefinitely. Upon termination of the offending party's business relationship with Draper, all outstanding balances shall become due and payable immediately. The offending party may request to be reinstated after the next annual pricing update, but Draper reserves the right to decide whether to accommodate this request. If the distributor or the authorized dealer is allowed to be reinstated, and another violation occurs, this likely will result in the removal of the distributor or the authorized dealer from Draper's distribution channel entirely.

Draper reserves the right, in its unilateral discretion, to take other action, including litigation, with respect to any distributor or authorized dealer that violates this MAP Policy. The MAP Policy will be enforced by Draper at its sole discretion in the best manner possible.

Since this policy is subject to change by Draper from time to time, distributors and authorized dealers must monitor Draper's website for the most current information related to MAP and review the posted MAP Policy regularly to ensure their continued compliance.

Draper representatives and employees are strictly prohibited from discussing the Policy or pricing practices with any account, as well as accepting any assurances of an account's compliance with the Policy. All inquiries regarding this Policy should be directed to Draper's Marketing Manager, Penny Sitler, at [psitler@draperinc.com](mailto:psitler@draperinc.com) or (765) 987-7999.

Finally, Draper will not discuss the business dealing of any account with any other account. Draper does not seek and will not accept any complaints or comments about the advertising or pricing policies of any other account. Draper continues to reserve the right to choose any accounts with which it will do business and reserves the right to accept or reject any purchase order from any account at any time.

# Freight Considerations

- Shipments are made by the least expensive surface method except when you request special routing at the time of order. On small parcel ground shipments, we use UPS—unless you specify otherwise. Several items in this price list “dim out” to a larger weight than their actual physical weight. When one item ships alone, it may have to ship under its dimensional weight or may incur an “Oversize” charge under parcel service regulations. Some items may also be too big for parcel service, and will ship common carrier. Please see key below, and notes on each individual product page. If in doubt, please request a freight estimate.
- Dimensional weights in this price list apply to parcel service shipments. Air freight shipments may also ship under a dimensional weight, which is calculated with a different formula. Contact Draper for a freight estimate.
- When you or your customer are expecting a delivery weighing more than 100 lbs., please plan appropriately for unloading the truck. The carrier is not responsible for unloading. If you need notification to do this, please request a call before delivery.
- We are glad to quote delivered prices based on your specific requirements. Unless you request it at the time of quotation, our delivered prices do not include extraordinary charges, inside delivery, construction site delivery, arrival notice or reconsignment.
- All shipments are prepaid and added to the invoice.
- Products throughout this price list are marked with their freight classification or with a “P” to indicate that they may be shipped via a small parcel ground service. Many products are marked with a designation such as “85P+” or “125”. Larger quantities may ship more economically via common carrier and will ship under the freight classification shown.
- Small parcel ground shipment frequently is not available for products shipping to Canada. Please see key below, and notes on each individual product page. If in doubt, please request a freight estimate.
- Actual shipping weights for crated products may vary due to crating methods and materials.
- Need a freight quote? Draper’s sales staff is always pleased to provide a freight estimate based on your specific needs. Just call 800.238.7999 or 765.987.7999.

*Use our online payment portal at [www.draperinc.com/pay](http://www.draperinc.com/pay).*

## Freight Classifications for Draper Products

Motorized Screens	125	Uprights & Horizontal Supports	85	VideoWalls	85*
Wall/Ceiling Screens	85	Projector Lifts	85/200	Projector Support Structures	100/200
Portable Screens	85	Revelation	110	MultiScreen System	125
Permanently Tensioned Screens	85	Cineglass Rear Projection Screens	100/125*	Video Conferencing Camera Box	70
Pipe & Drape Runoffs		Cineplex Rear Projection Screens	100/125*	RPX Rear Projection System	125
Skirts and Draping	70	IRUS	100/125*	First Surface Mirrors	100
Bases	50				

\*Depending on dimensions: call for freight quotation.

## Freight Damage Policy—Please Read

One of our biggest mutual headaches is freight damage. There are two kinds—

### Obvious Freight Damage

If you receive a shipment from us with obvious freight damage, **REFUSE IT** and inform us immediately so we can supply a replacement. We will charge you for the replacement at the originally quoted price and credit you upon the return of the original.

If you accept a shipment with obvious freight damage noted on the driver receipt and report it to us after the fact, we will supply a replacement at the originally quoted price and provide a partial credit upon the return of the original, based on its salvage value. The damaged product must be held at the original delivery address and in its original packaging.

### Concealed Freight Damage

If you accept a shipment, it is **your responsibility** to open it immediately and report any concealed freight damage to the delivering carrier immediately and in writing. Pursuing the claim is also your responsibility, but we will assist you to the best of our ability to secure a favorable settlement from the carrier. We will also provide a replacement product at the originally quoted price; and, if your claim is denied, we may accept the return of the freight damaged product for whatever credit we can provide, based upon its salvage value.

If you fail to report concealed freight damage to the delivering carrier immediately, neither you nor we have any recourse. We will provide a replacement product at the originally quoted price and, if you wish, we will accept the return of the damaged product for whatever credit we can provide, based upon its salvage value.

### Please Note—

1. This policy applies to all shipments whether to you or to your customers.
2. Freight damaged rigid rear screens have no salvage value.
3. Neither Draper nor the freight carrier will pay back charges, accessorial fees or expedited replacement charges in regard to freight damaged product and replacement.

# Alphabetical Index

## Information and Communication

Communicating with Draper . . . . .	107
Freight Considerations . . . . .	111
Freight Damage Policy . . . . .	111
Part Number Prefix Key . . . . .	109
Terms and Conditions . . . . .	109

## Product Types and Accessories

Accessories for Manual Screens . . . . .	45
Accessories for Electric Screens . . . . .	35
AV Mounts & Structures . . . . .	86
Lift Control Options . . . . .	98
Manually Operated Screens . . . . .	37
Electric Projection Screens . . . . .	8
Networking Controls . . . . .	35
Fixed Projection Screens . . . . .	47
Portable Projection Screens . . . . .	61
Projector Lifts . . . . .	90
Projector Support Structures . . . . .	91
Quiet Motors and Built-in Controls . . . . .	36
Rigid Rear Projection Screens . . . . .	82
SmartTrim™ for Barco UniSee® . . . . .	89
Video Conferencing Backgrounds . . . . .	99
Video Conferencing Solutions . . . . .	97

## Product Index

Access Cases . . . . .	10
Access FIT E . . . . .	22
Access FIT V . . . . .	11
Access E . . . . .	21
Access V . . . . .	12
Access M . . . . .	38
Access FIT M . . . . .	38
Access XL E . . . . .	22
Access XL V . . . . .	13
Acrobat . . . . .	92
AeroLift . . . . .	96
AutoReturn Roller for Manual Projection Screens . . . . .	37
Ceiling Access Doors . . . . .	95
Cinefold . . . . .	75
Cineframe® . . . . .	84
Cineperm . . . . .	49
Cinescreen® Rear Screens . . . . .	83
Clarion . . . . .	51
Credenza Projector Lift . . . . .	93
Curved Frame Screens . . . . .	48
Custom Cube Stands . . . . .	82
Custom Lifts . . . . .	92
Diplomat R . . . . .	63
Draperies . . . . .	80
Dress Kits for Cinefold . . . . .	76
Dress Kits for Truss-Style Cinefold . . . . .	79
Dress Kits for Ultimate Folding Screen . . . . .	73
Easels and Accessories . . . . .	81
Edgeless Clarion . . . . .	58
First Surface Mirrors . . . . .	85
Fly Cages . . . . .	91

FocalPoint® . . . . .	69
FocalPoint® Dress Kits . . . . .	70
IRUS—Infinite Resolution Uniformity Screen . . . . .	83
Lace & Grommet Screens . . . . .	60
LCD Lift . . . . .	93
Luma . . . . .	43
Luma 2 . . . . .	44
Luma 2 R Screen for use with Floor Stand . . . . .	62
Micro Projector Lift . . . . .	93
MiroClear . . . . .	85
Mirror Manager . . . . .	85
MultiScreen System . . . . .	82
Nocturne® C . . . . .	45
Nocturne® E . . . . .	33
Onyx . . . . .	54
Paragon E . . . . .	25
Paragon V . . . . .	16
Patriot . . . . .	33
Pipe & Drape Runoffs . . . . .	80
Premier . . . . .	17
Premier XL . . . . .	19
Premier C . . . . .	40
Profile+ . . . . .	59
Replacement Viewing Surfaces . . . . .	46
Revelation . . . . .	95
Rolleramic . . . . .	26
Ropewalker . . . . .	34
RPX Rear Projection Systems . . . . .	85
Salara HW . . . . .	31
Salara Plug & Play™ . . . . .	32
Salara M . . . . .	42
Scissor Lifts . . . . .	94
Screen Fabric Only, Cut to Size . . . . .	47
ShadowBox Clarion . . . . .	57
Silent Partner . . . . .	91
Silhouette C . . . . .	40
Silhouette E . . . . .	30
Silhouette M . . . . .	41
Silhouette V . . . . .	20
Skirts for Mobile AV Carts and Tables . . . . .	62
Skirts For Diplomat . . . . .	63
StageScreen® . . . . .	64
StageScreen® Dress Kits . . . . .	68
Targa . . . . .	27
Targa XL . . . . .	29
Traveller . . . . .	61
Truss-Style Cinefold . . . . .	79
Ultimate Access E . . . . .	23
Ultimate Access V . . . . .	14
Ultimate Access XL E . . . . .	24
Ultimate Access XL V . . . . .	15
Ultimate Folding Screen . . . . .	71
Ultimate Folding Screen and Cinefold Cases . . . . .	78
VideoWalls . . . . .	82

Detailed product brochures are available on request. You may also find the most current photos, descriptions and specifications on the Internet at:

**[draperinc.com](http://draperinc.com)**



Draper, Inc. | 411 S. Pearl St. Spiceland, IN 47385  
draperinc.com | 800.238.7999 | Fax: 800.323.0522

© 2020 All Rights Reserved | Updated 3.6.20 | Form: AV420R

