

IFPG1 Series

Commercial Touch Display

User Guide

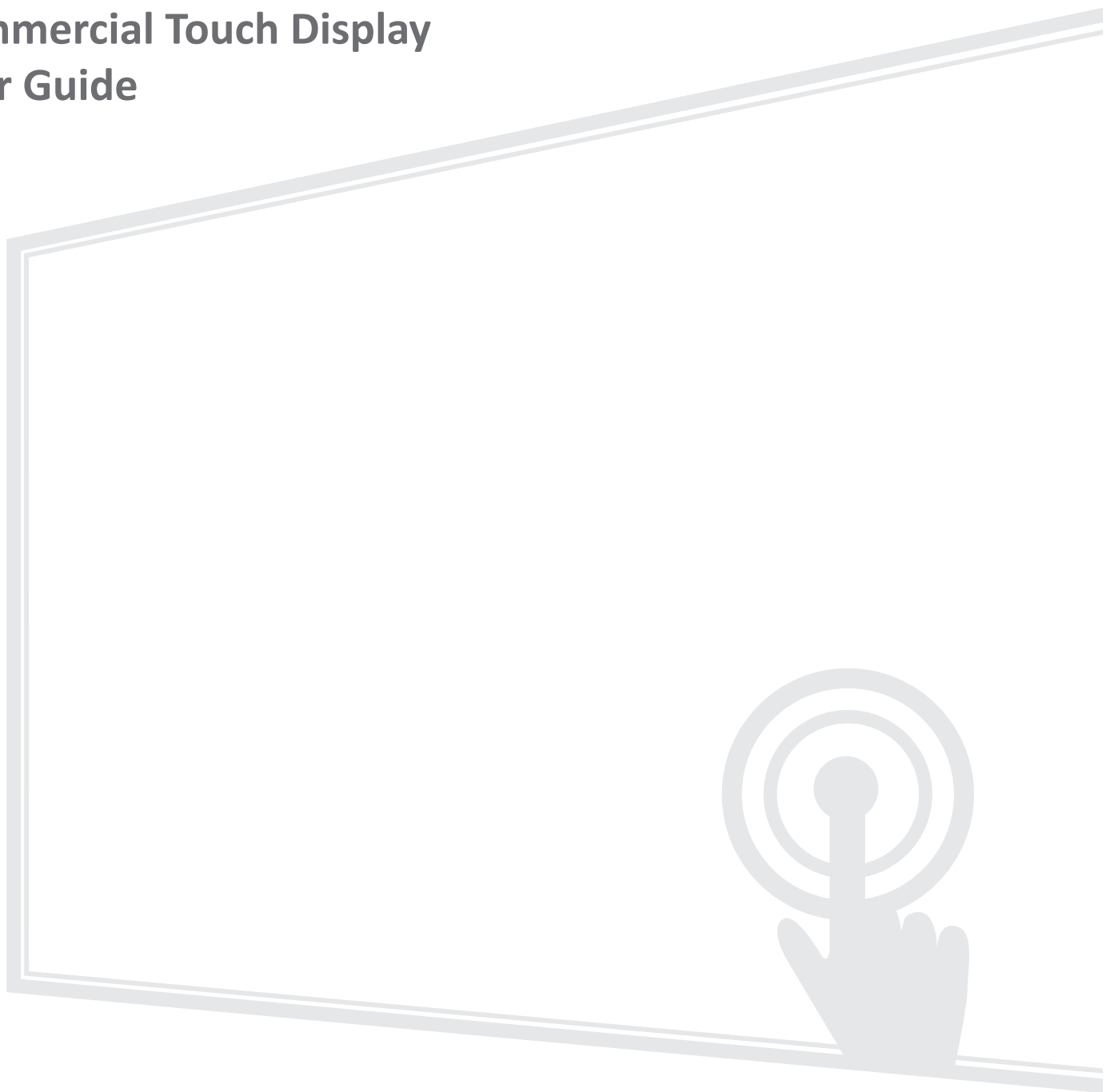

IMPORTANT: Please read this User Guide to obtain important information on installing and using your product in a safe manner, as well as registering your product for future service. Warranty information contained in this User Guide will describe your limited coverage from ViewSonic® Corporation, which is also found on our web site at <http://www.viewsonic.com> in English, or in specific languages using the Regional selection box of our website.

Model No. VS19763 | VS19764 | VS19765 | VS19766
P/N: IFP55G1 | IFP65G1 | IFP75G1 | IFP86G1

Thank you for choosing ViewSonic®

As a world-leading provider of visual solutions, ViewSonic® is dedicated to exceeding the world's expectations for technological evolution, innovation, and simplicity. At ViewSonic®, we believe that our products have the potential to make a positive impact in the world, and we are confident that the ViewSonic® product you have chosen will serve you well.

Once again, thank you for choosing ViewSonic®!

Safety Precautions

Please read the following **Safety Precautions** before you start using the device.

- Keep this user guide in a safe place for later reference.
- Read all warnings and follow all instructions.
- Do not use the device near water. To reduce the risk of fire or electric shock, do not expose the device to moisture.
- Never remove the rear cover. This display contains high-voltage parts. You may be seriously injured if you touch them.
- Avoid exposing the device to direct sunlight or other sources of sustained heat.
- Do not install near any heat sources such as radiators, heat registers, stoves, or other devices (including amplifiers) that may increase the temperature of the device to dangerous levels.
- Use a soft, dry cloth to clean the external housing. For more information, refer to the "Maintenance" section.
- When moving the device, be careful not to drop or bump the device on anything.
- Do not place the device on an uneven or unstable surface. The device may fall over resulting in an injury or a malfunction.
- Do not place any heavy objects on the device or connection cables.
- If smoke, an abnormal noise, or a strange odor is present, immediately turn the device off and call your dealer or ViewSonic®. It is dangerous to continue using the device.
- The device is a monitor with an LED backlight intended for general office use.
- Do not attempt to circumvent the safety provisions of the polarized or grounding-type plug. A polarized plug has two blades with one wider than the other. A grounding-type plug has two blades and a third grounding prong. The wide blade and the third prong are provided for your safety. If the plug does not fit into your outlet, obtain an adapter and do not attempt to force the plug into the outlet.
- When connecting to a power outlet, DO NOT remove the grounding prong. Please ensure grounding prongs are NEVER REMOVED.
- Protect the power cord from being treaded upon or pinched, particularly at the plug, and at the point where it emerges from the equipment. Ensure that the power outlet is located near the equipment so that it is easily accessible.

- Only use attachments/accessories specified by the manufacturer.
- When a cart is used, use with caution when moving the cart/equipment combination to avoid injury from tipping over.
- Disconnect the power plug from the AC outlet if the device is not being used for a long period of time.
- Place the device in a well-ventilated area. Do not place anything on the device that prevents heat dissipation.

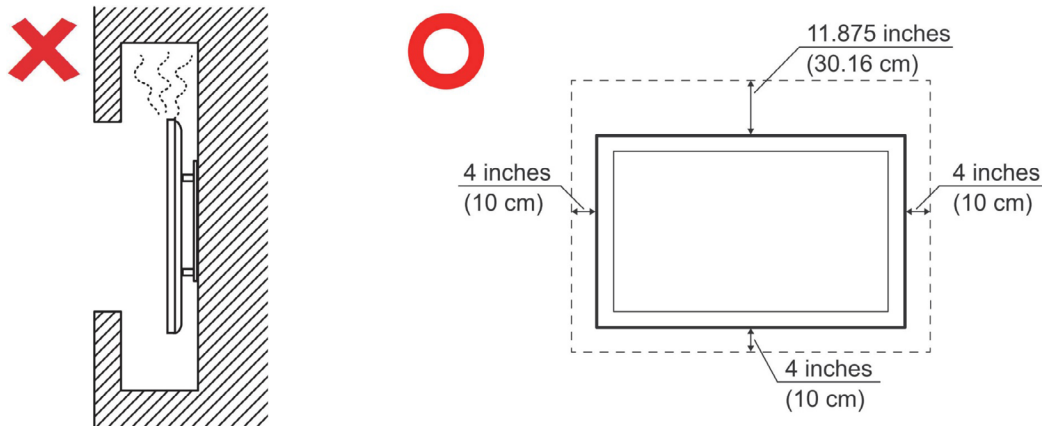

- Refer all servicing to qualified service personnel. Service will be required when the unit has been damaged in any way, such as:
 - » if the power supply cord or plug is damaged
 - » if liquid is spilled onto or objects fall in the unit
 - » if the unit is exposed to moisture
 - » if the unit does not operate normally or has been dropped

Contents

Safety Precautions.....	3
Introduction	8
Package Contents	8
Wall Mount Kit Specifications (VESA)	9
IFP55G1	9
IFP65G1	10
IFP75G1	11
IFP86G1	12
Product Overview	13
IFP55G1	13
IFP65G1	14
IFP75G1	15
IFP86G1	16
Control Panel.....	17
I/O Panels	18
Front I/O.....	19
Rear I/O	20
Side I/O.....	21
Remote Control	23
Using Gestures	27

Making Connections	29
Connecting to Power	29
Connecting External Devices and Touch Connection	30
C Type Connection	31
HDMI Connection	31
VGA Connection	31
RS-232 Connection	32
USB and Networking Connections.....	33
USB Peripherals	33
Networking and Modem cables	33
Media Player Connection	34
Audio Connection	35
Audio In	35
Audio Out	35
Optional Connections	36
Slot-in PC (OPS Slot) Installation	36
Using Your ViewBoard	37
Powering ON/OFF your ViewBoard	37
On-Screen Display (OSD) Menu Tree.....	38
On-Screen Display (OSD) Menu Operation.....	43
VGA	44
Picture	45
Audio	47
Time	48
About.....	49
Advanced Options	50
Other Settings	52
Low Blue Light Filter and Eye Health.....	53

RS-232 Protocol.....	55
Description	55
RS-232 Hardware Specification	55
LAN Hardware Specification.....	56
RS-232 Communication Setting.....	56
LAN Communication Setting	56
Command Message Reference.....	56
Appendix.....	57
Specifications.....	57
Display Timing Modes	59
HDMI	59
USB C Type	59
VGA	60
Troubleshooting	61
Maintenance.....	63
General Precautions.....	63
Cleaning the Screen.....	63
Cleaning the Case	63
Regulatory and Service Information	64
Compliance Information.....	64
FCC Compliance Statement.....	64
Industry Canada Statement.....	64
CE Conformity for European Countries.....	64
Declaration of RoHS2 Compliance.....	65
ENERGY STAR Statement.....	66
Indian Restriction of Hazardous Substances	66
Product Disposal at End of Product Life	66
Copyright Information	67
Customer Service	68
Limited Warranty	69
Mexico Limited Warranty.....	72

Wall Mount Kit Specifications (VESA)

NOTE: Please follow the instructions in the wall mount installation guide to install your wall mount or mobile mount bracket. If attaching to other building materials, please contact your nearest dealer.

IFP55G1

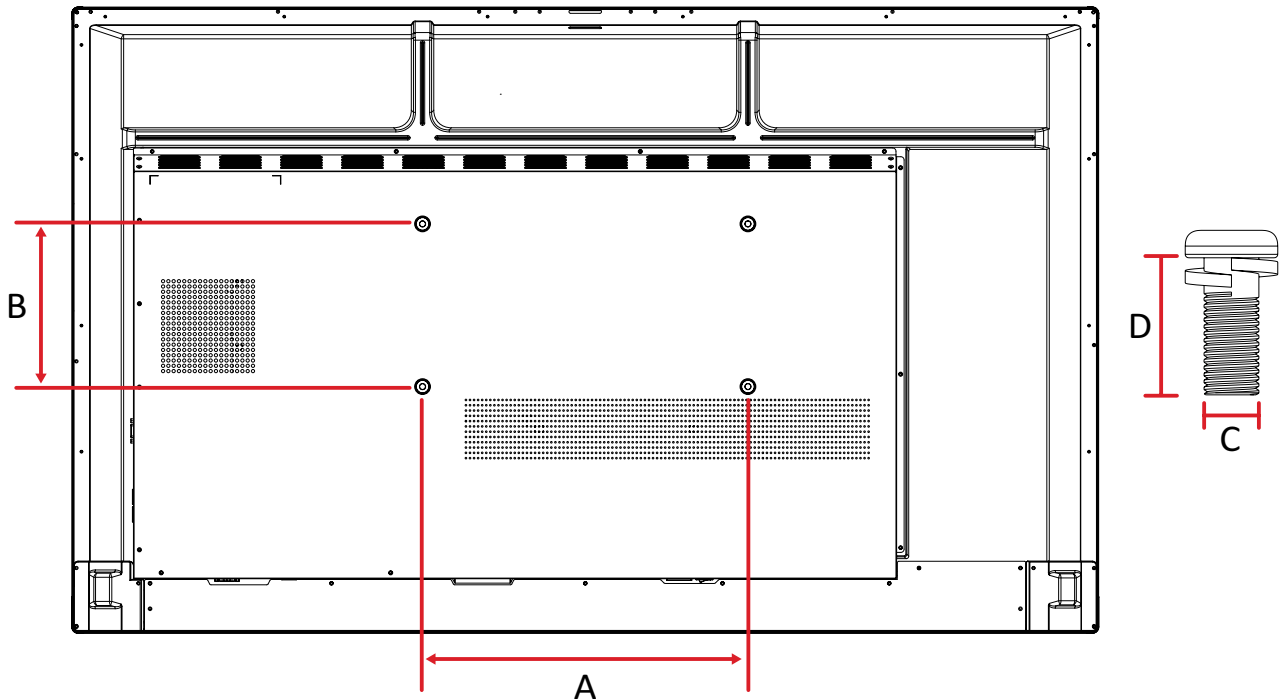

Model	VESA Spec. (A x B)	Standard Screw (C x D)	Quantity
IFP55G1	400 x 200 mm	M8 x 25 mm	4

NOTE: Do not use screws that are longer than the standard dimension, as they may cause damage to the inside of the display.

IFP65G1

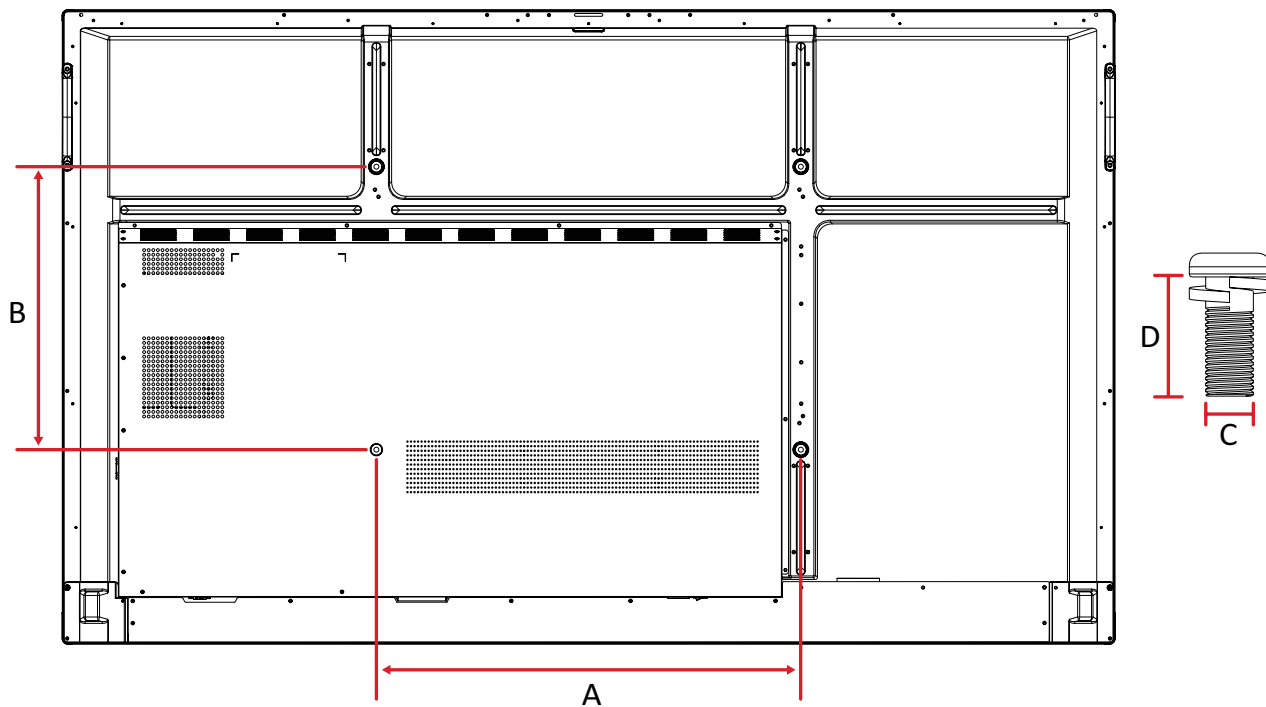

Model	VESA Spec. (A x B)	Standard Screw (C x D)	Quantity
IFP65G1	600 x 400 mm	M8 x 25 mm	4

NOTE: Do not use screws that are longer than the standard dimension, as they may cause damage to the inside of the display.

IFP75G1

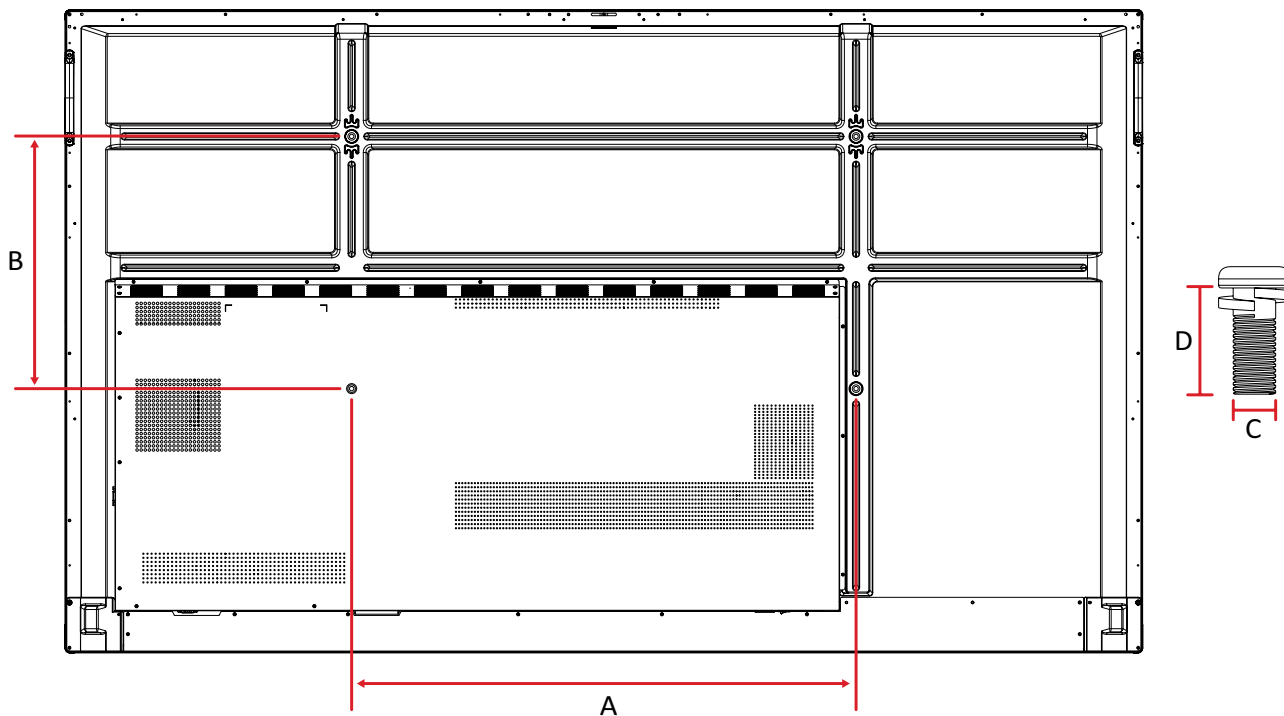

Model	VESA Spec. (A x B)	Standard Screw (C x D)	Quantity
IFP75G1	800 x 400 mm	M8 x 25 mm	4

NOTE: Do not use screws that are longer than the standard dimension, as they may cause damage to the inside of the display.

IFP86G1

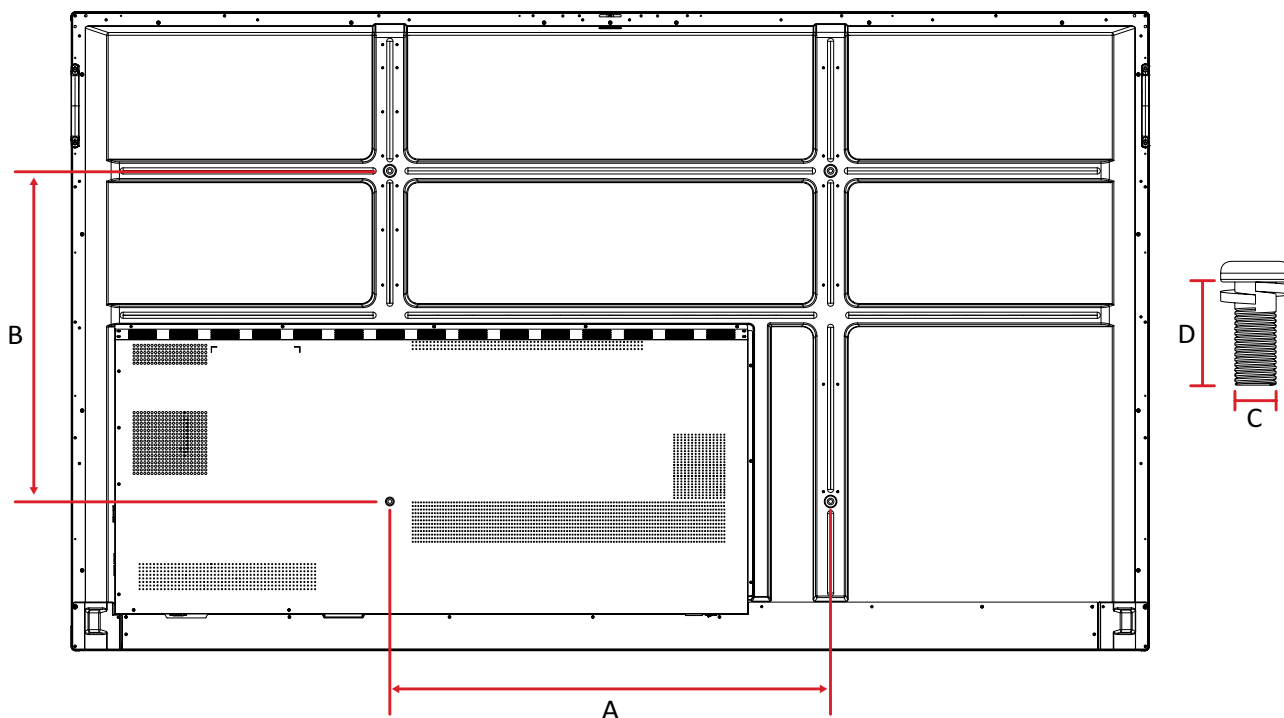

Model	VESA Spec. (A x B)	Standard Screw (C x D)	Quantity
IFP86G1	800 x 600 mm	M8 x 25 mm	4

NOTE: Do not use screws that are longer than the standard dimension, as they may cause damage to the inside of the display.

Product Overview

IFP55G1

Front Panel

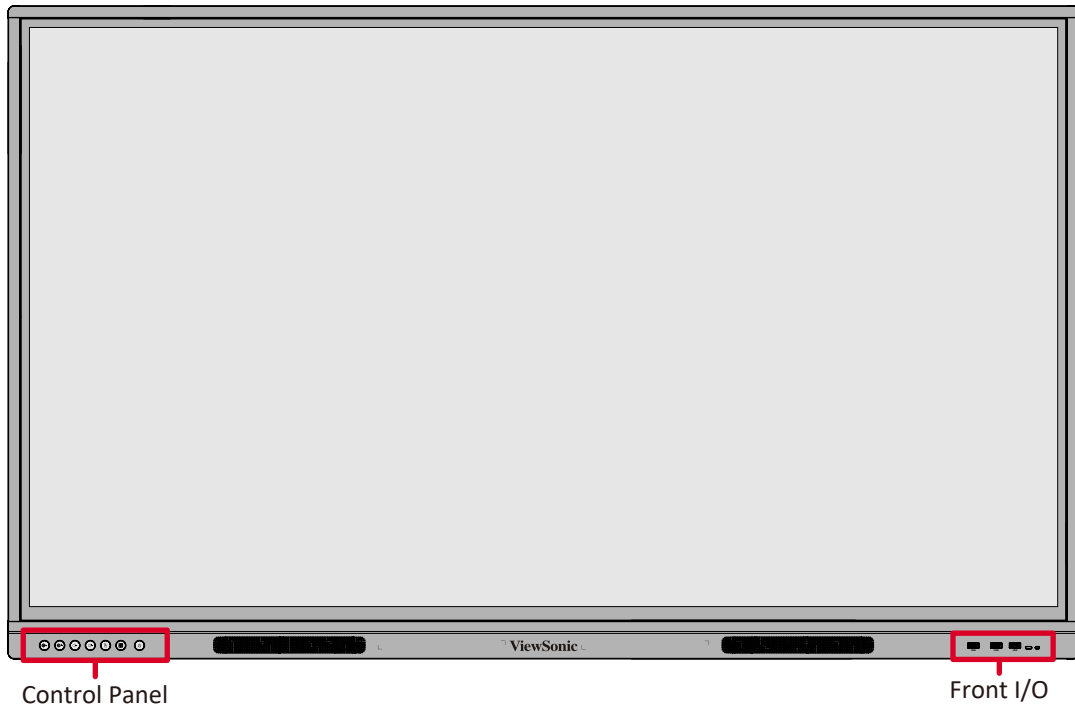

Rear Panel

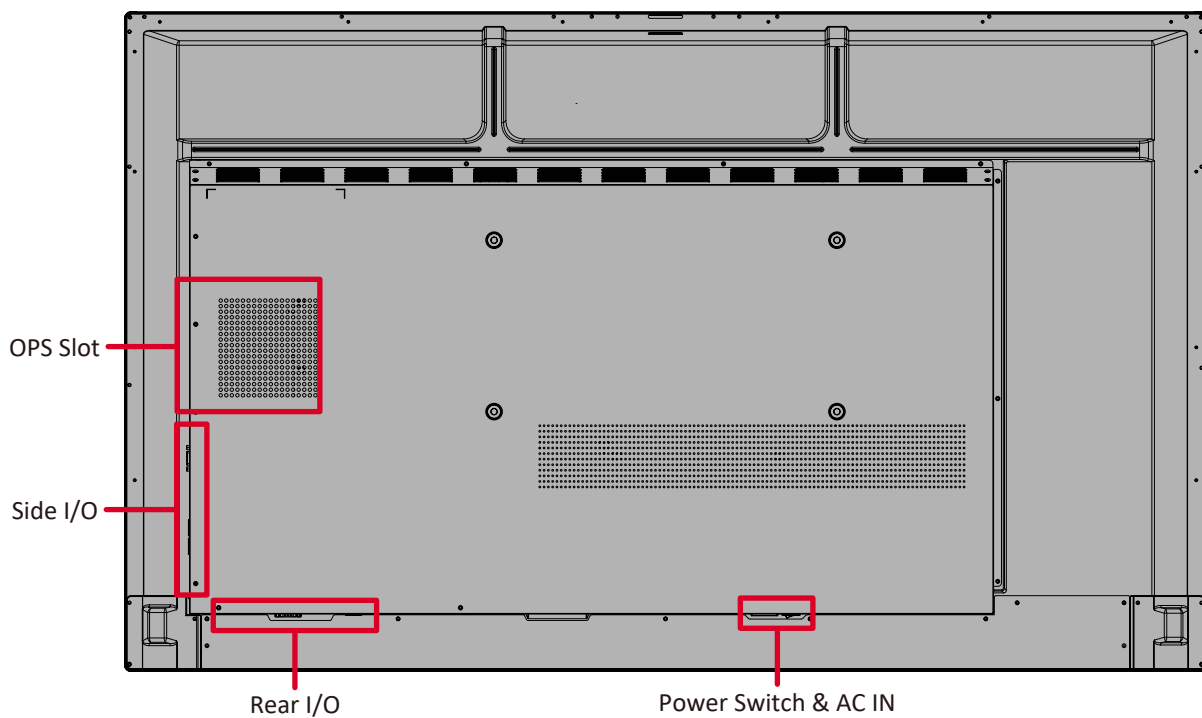

IFP65G1

Front Panel

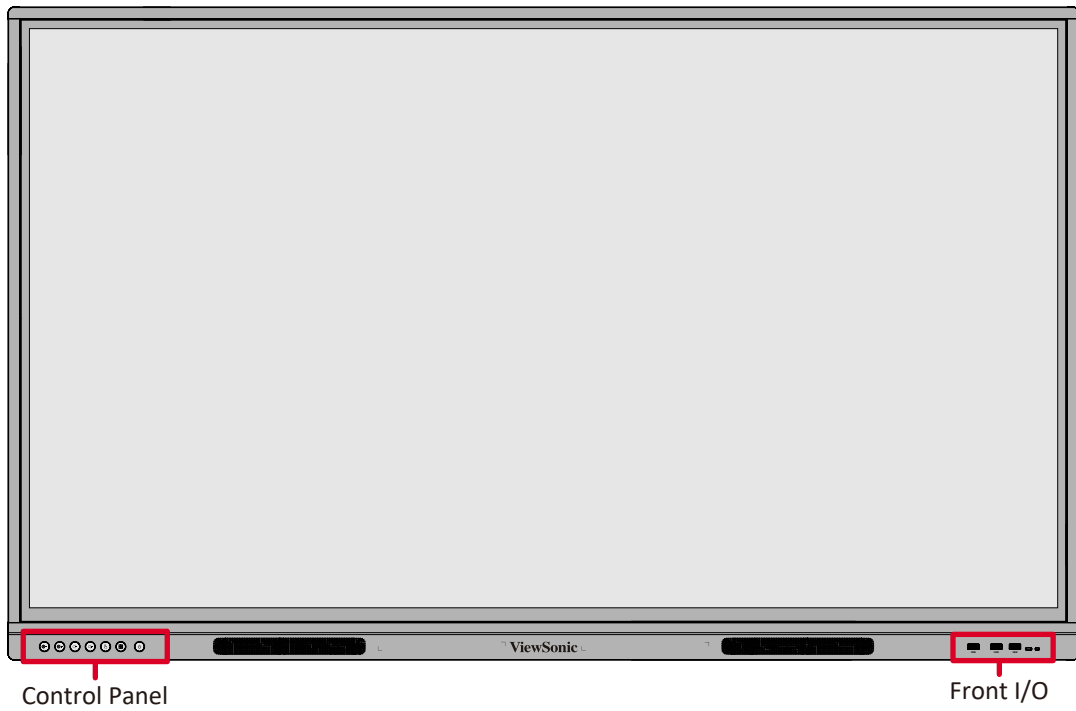

Rear Panel

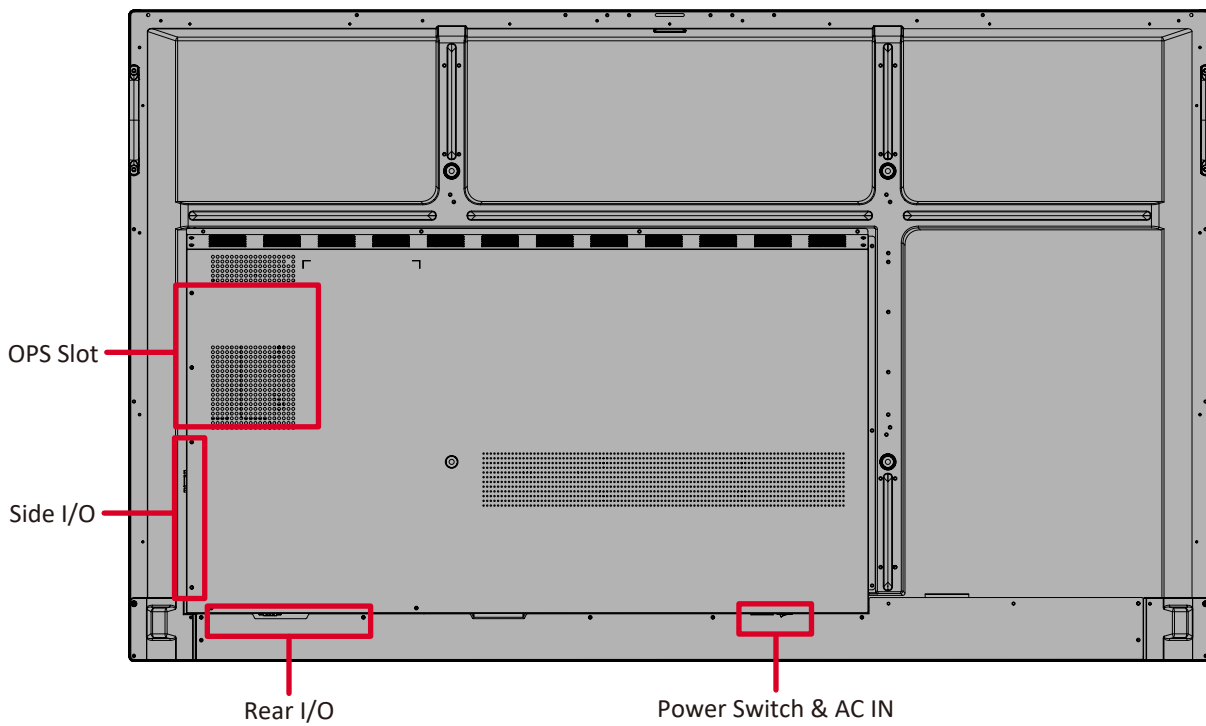

IFP75G1

Front Panel

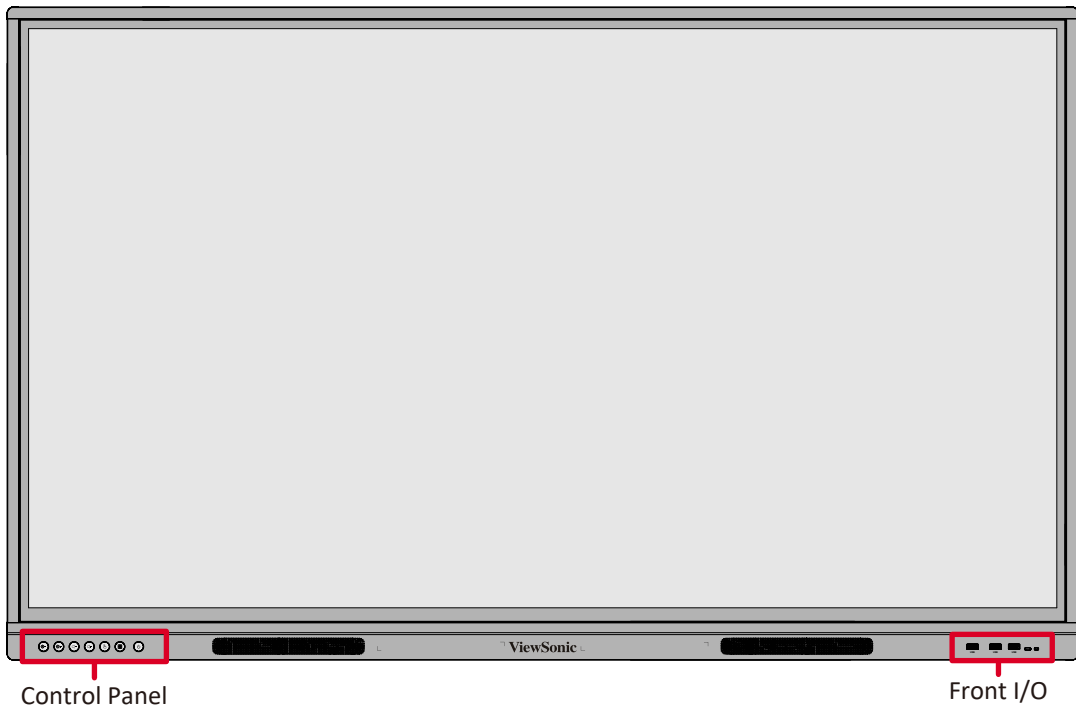

Rear Panel



IFP86G1

Front Panel

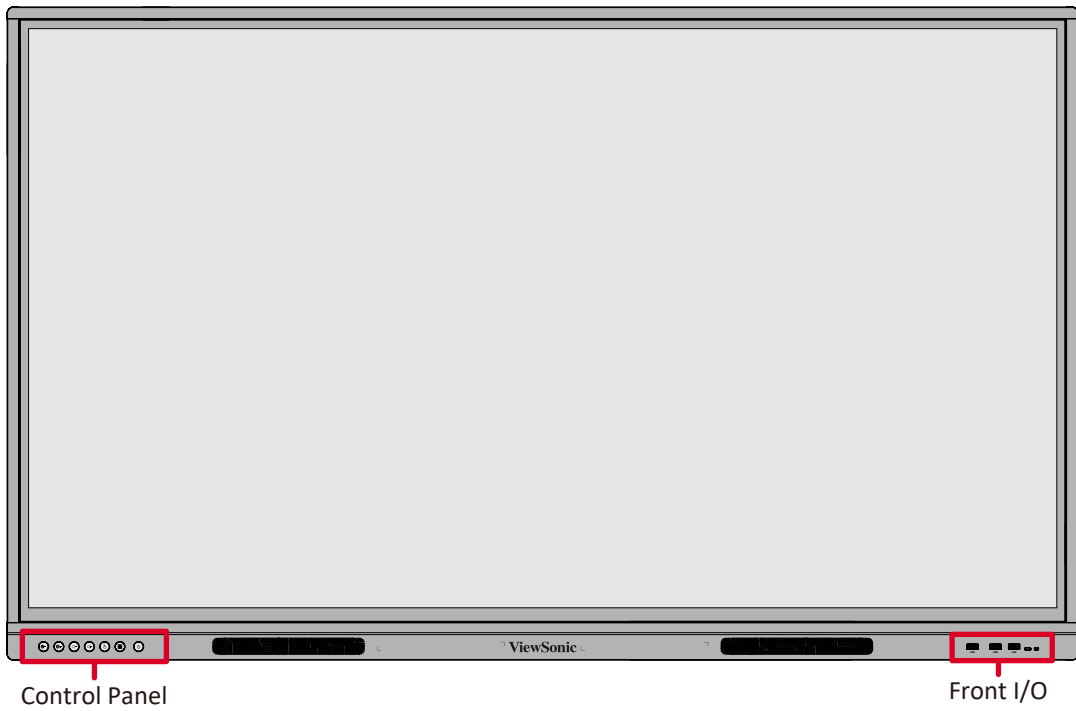



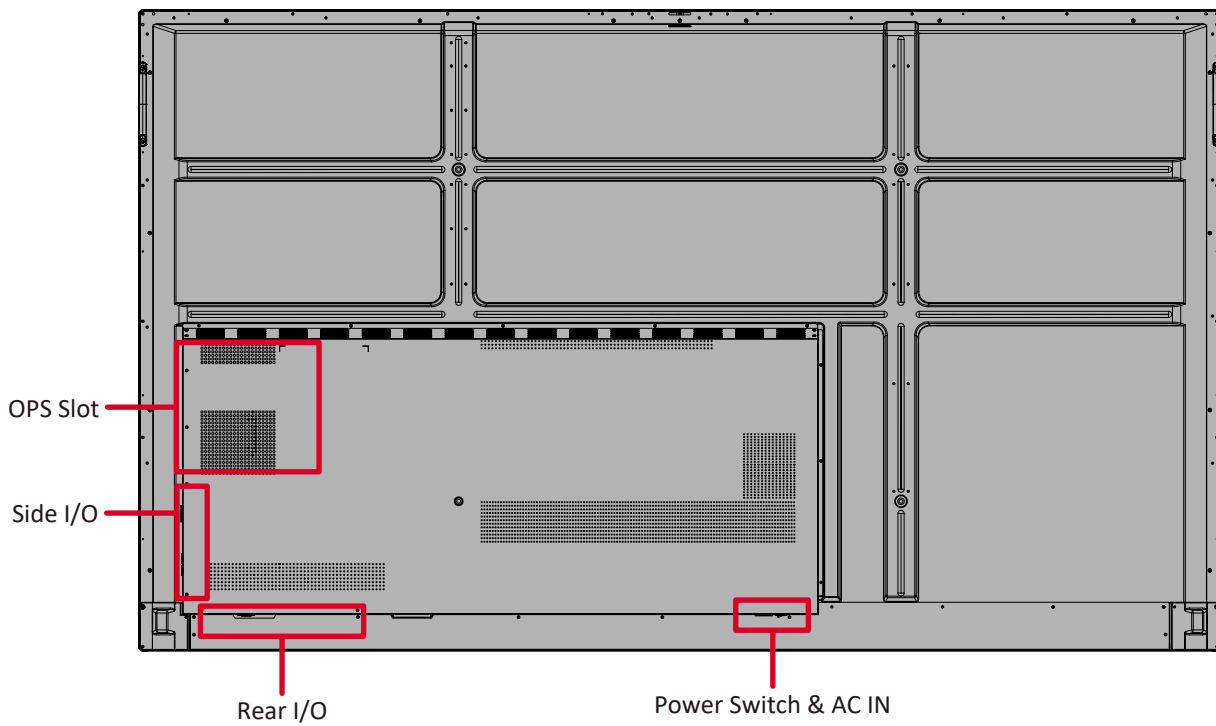

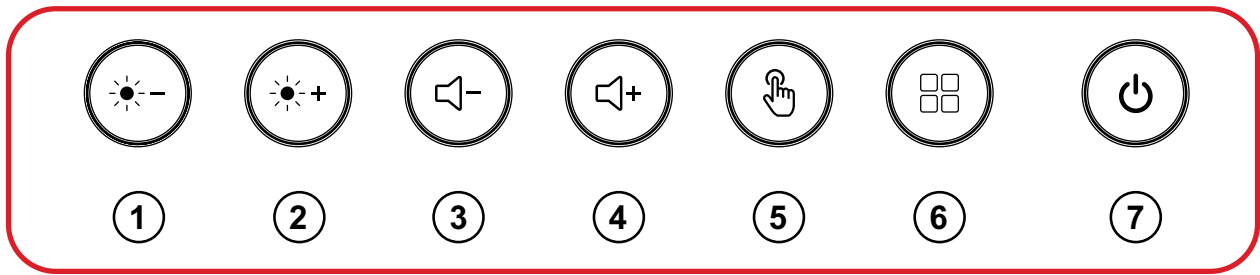

Rear Panel



Control Panel



Number	Item	Description
1		Decrease screen brightness
2		Increase screen brightness
3		Decrease the volume
4		Increase the volume
5		Disable/Enable the touch screen
6		Launch the Menu system
7		<ul style="list-style-type: none">• Power indicator light• Press to turn ON the device• Press to turn OFF/ON the display backlight only• Press and hold to turn OFF the device

I/O Panels

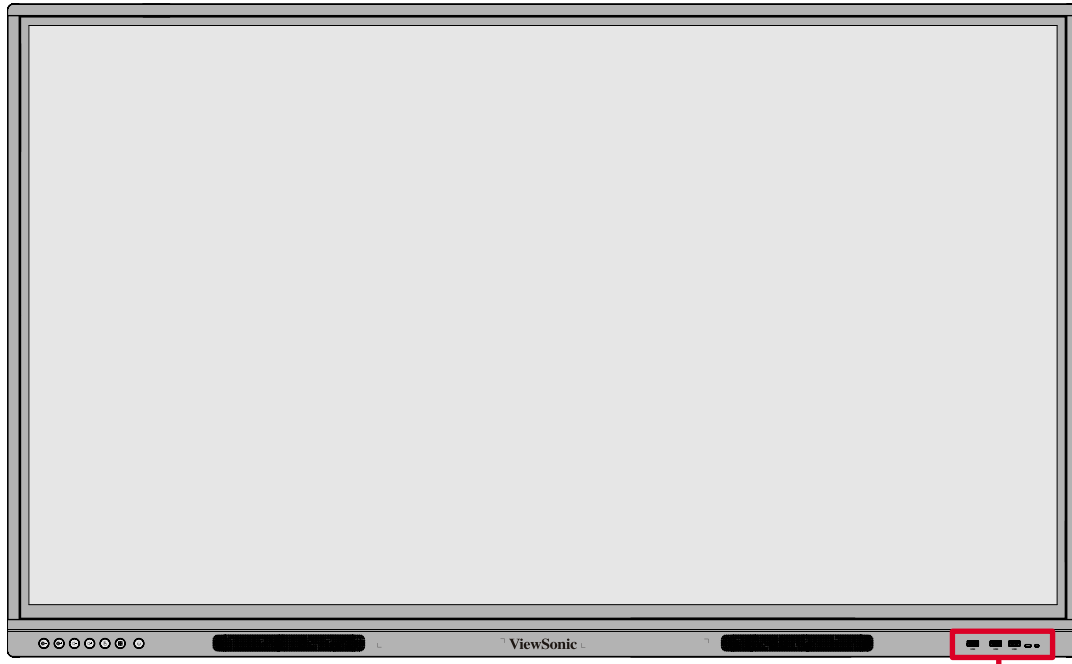

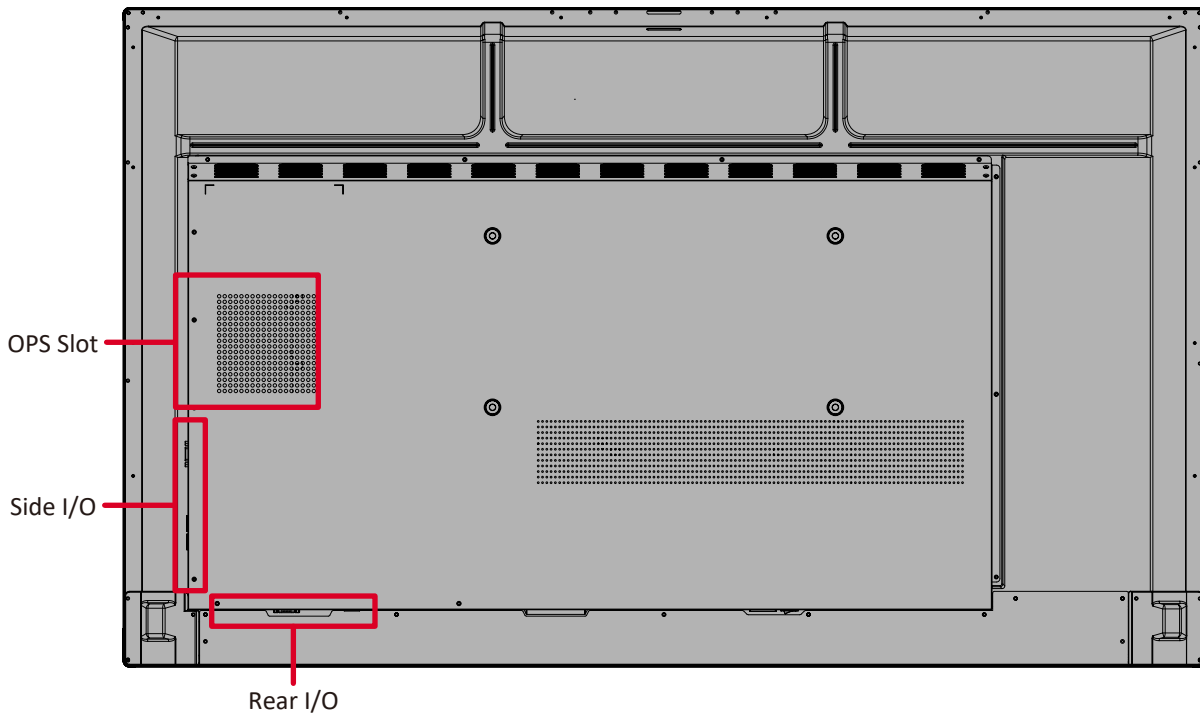

Front I/O

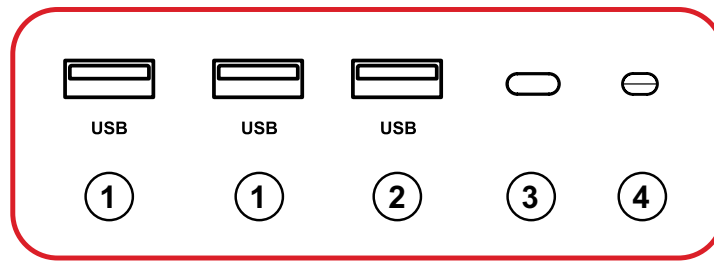

Front I/O



Number	Item	Description
1	USB	<ul style="list-style-type: none"> • USB Type A input • USB 3.0 standard • Connect USB devices such as hard disks, keyboard, mouse, etc. • Automatically switches between the external computer and ViewBoard
2	USB	<ul style="list-style-type: none"> • USB Type A input • USB 2.0 standard
3		Remote control receiver
4		Ambient Light Sensor

Rear I/O

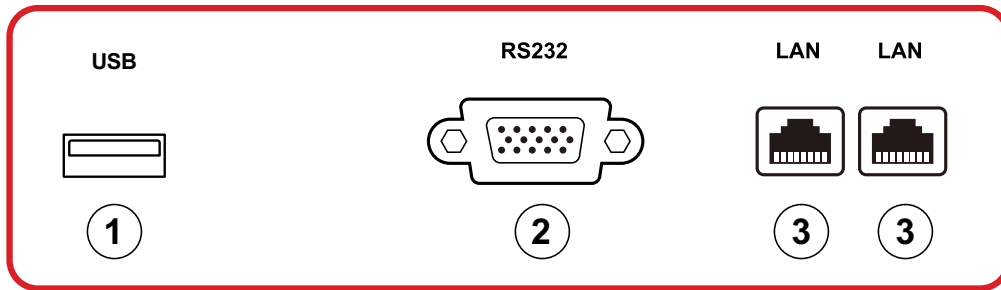

Number	Item	Description
1	USB	<ul style="list-style-type: none">• USB Type A input• USB 2.0 standard
2	RS232	Serial interface; used for mutual transfer of data between devices
3	LAN	Standard RJ45 (10M/100M/1000M) Internet connection interface. Features hub support for network sharing.

Side I/O

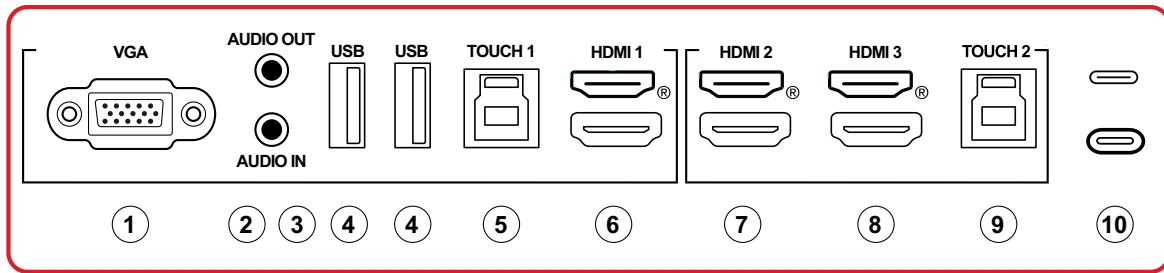



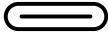



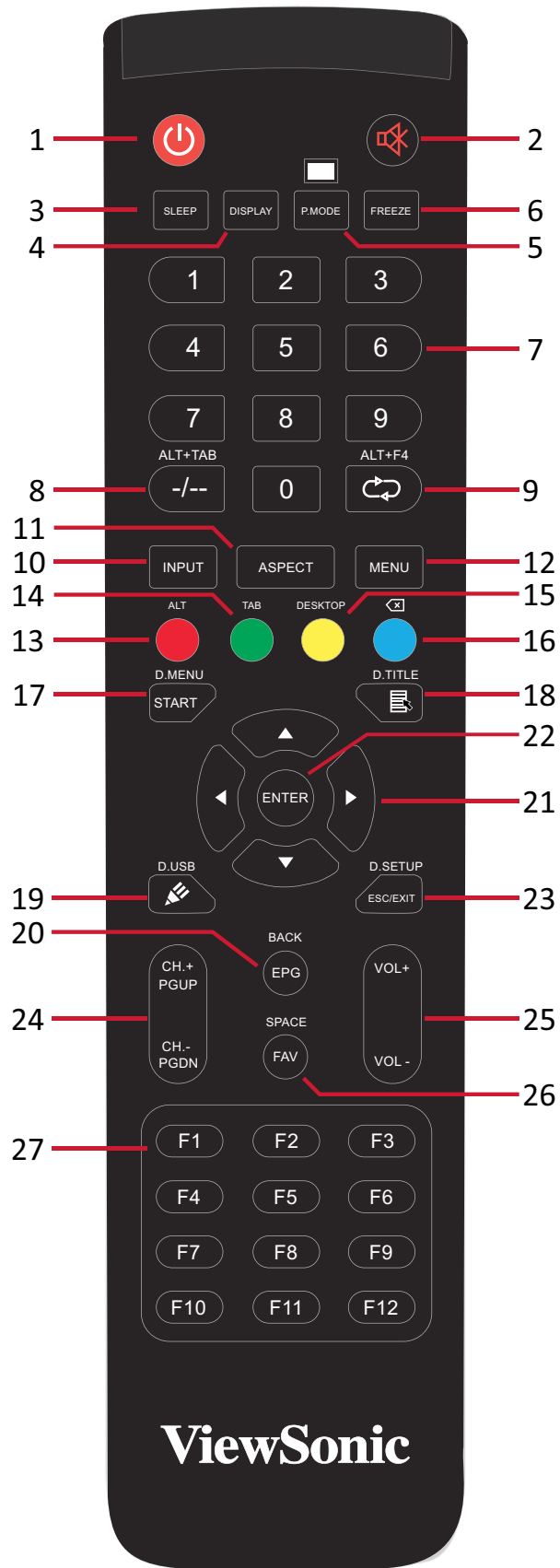



Number	Item	Description
1	VGA	External computer video input
2	AUDIO OUT	Audio output to an external speaker/headset
3	AUDIO IN	External computer audio input
4	USB	<ul style="list-style-type: none"> • USB Type A input • USB 3.0 standard • Connect USB devices such as hard disks, keyboard, mouse, etc.
5	TOUCH 1	<ul style="list-style-type: none"> • USB Type B • Touch signal output to external computer • After connection (with an external computer), the device connected to the USB port can directly be used by the external computer <p>NOTE: Pairs with the HDMI 1 port.</p>
6	HDMI 1	<ul style="list-style-type: none"> • HDMI input • Connect to a computer with HDMI output, set-top box, or other video device • Supports 4K display; HDMI v. 2.0; CEC; ARC
7	HDMI 2	<ul style="list-style-type: none"> • HDMI input • Connect to a computer with HDMI output, set-top box, or other video device • Supports 4K display; HDMI v. 2.0; CEC; ARC
8	HDMI 3	<ul style="list-style-type: none"> • HDMI input • Connect to a computer with HDMI output, set-top box, or other video device • Supports 4K display; HDMI v. 2.0; CEC; ARC
9	TOUCH 2	<ul style="list-style-type: none"> • USB Type B • Touch signal output to external computer • After connection (with an external computer), the device connected to the USB port can directly be used by the external computer <p>NOTE: Pairs with the HDMI 2 and HDMI 3 ports.</p>

Number	Item	Description
10		<ul style="list-style-type: none">• C Type Port input• USB 3.0 standard• Supports DP v. 1.2 with audio, video, and touch• Supports power charge up to 65W. Power charge supported: 5V/3A, 9V/3A, 15V/3A, 20V/3.25A

Remote Control



Number	Item	Description
1		Power on/off
2		Mute/Unmute
3	SLEEP	Sleep Mode
4	DISPLAY	For Non-Android sources; display current input source information
5	P.MODE	Blank Screen
6	FREEZE	Freeze Screen
7		Numeric input buttons
8	ALT+TAB -/--	Slot-in computer space bar Alt+Tab
9	ALT+F4 	Slot-in computer, close program window
10	INPUT	Input source selection
11	ASPECT	Back to slot-in system main interface
12	MENU	Access Settings
13	Red / ALT	Screen capture
14	Green / TAB	PC ¹ [Tab] button
15	Yellow / DESKTOP	Switch to slot-in PC desktop
16	BLUE/ 	PC ¹ [Backspace] button
17	START / D.MENU	PC ¹ [Windows] button
18	 / D.TITLE	PC ¹ [Menu] button
19	 / D.USB	Writing software setup
20	EPG/BACK	Return button
21	 /  /  / 	Scroll up, down, left, and right
22	ENTER	Confirm selection/state
23	ESC / EXIT / D.SETUP	Shortcut button to exit dialogue boxes
24	CH.+ / PGUP / CH.- / PGDN	CH+: PC previous page CH-: PC next page
25	VOL+ / VOL-	Increase/Decrease volume
26	FAV / SPACE	PC ¹ [Space] button
27	F1-F12	Built-in computer F1 - F12 function button

¹ All computer-related function keys are not available without a slot-in computer.

Inserting Remote Control Batteries

To insert batteries into the remote control:

1. Remove the cover on the rear of the remote control.
2. Insert two “AAA” batteries, ensuring the “+” symbol on the battery matches the “+” on the battery post.
3. Replace the cover by aligning it with the slot on the remote control and snapping the latch shut.

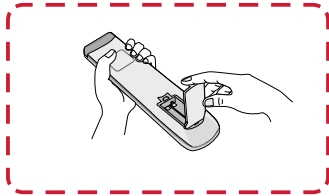

(1)

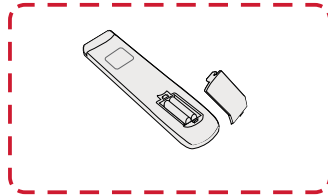

(2)



(3)

WARNING: There is a risk of explosion if batteries are replaced with the incorrect type.

NOTE:

- It is recommended that you do not mix battery types.
- Always dispose of old batteries in an environmentally friendly way. Contact your local government for more information on how to dispose of batteries safely.

Remote Control Receiver Range

The working range of the remote control is shown here. It has an effective range of 8 meters, 30° degrees left and right. Ensure there is nothing obstructing the remote control's signal to the receiver.

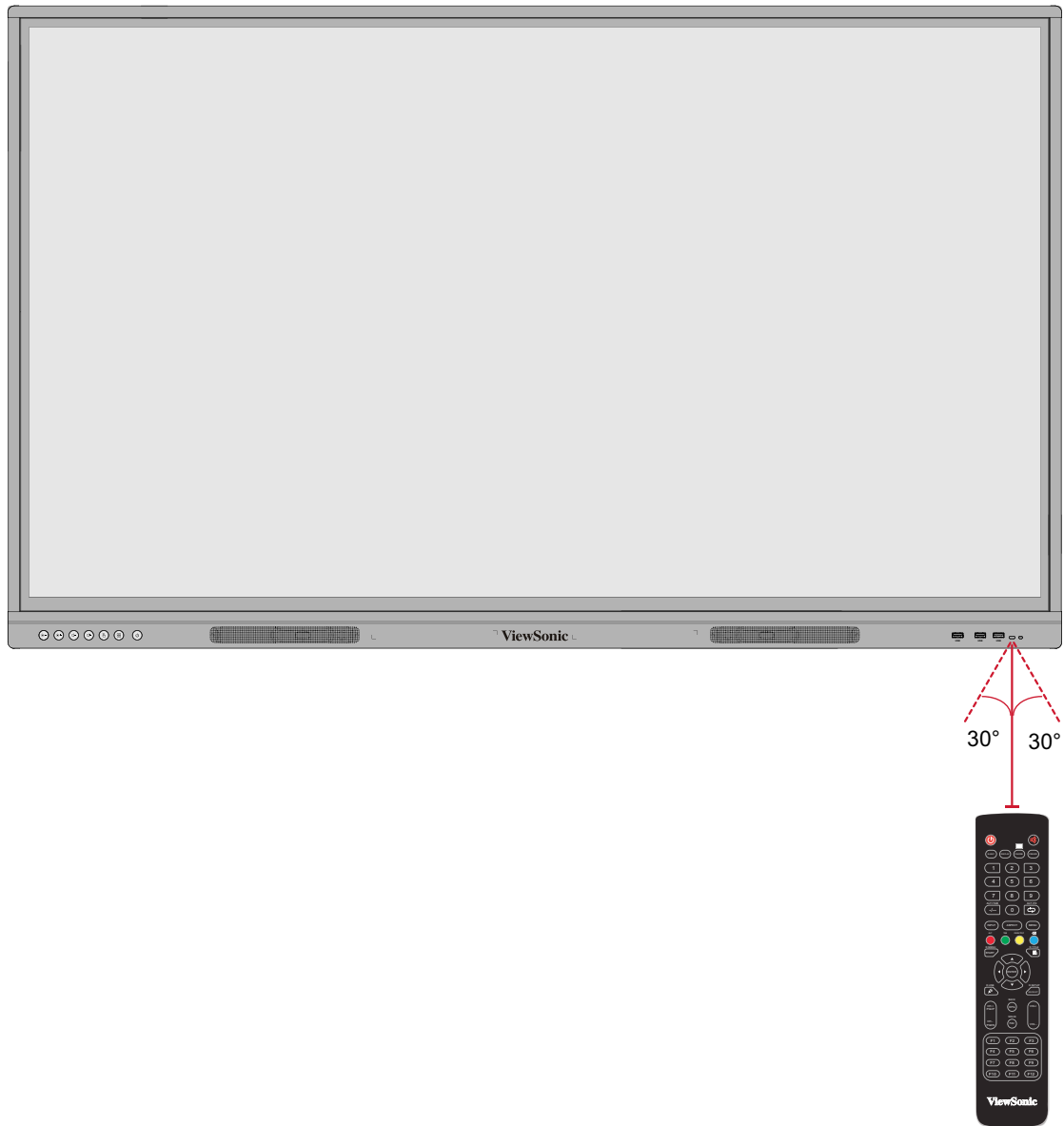

Using Gestures

Touch gestures allow the user to use pre-determined commands without using a keyboard or mouse. Using gestures on the ViewBoard, the user can select/deselect objects, change the location of an object, access settings, erase digital ink, and much more.

Select and Deselect an Object (Clicking)

Press and release the ViewBoard to select/deselect options or objects. This is like a single, standard left mouse click.

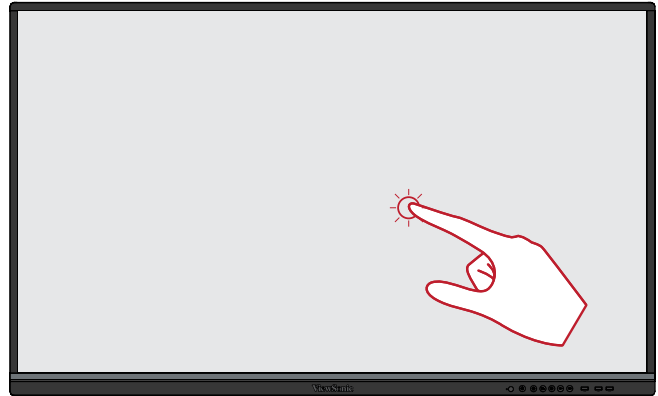

Display Menu Options (Right-Clicking)

Press and hold the ViewBoard with your finger. This is like a single, standard right mouse click.

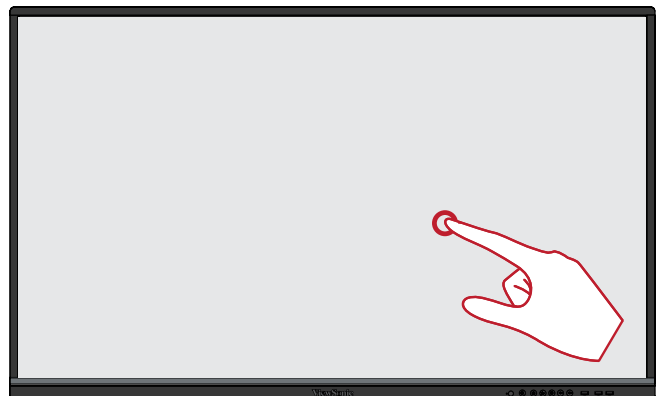

Double-Clicking

Quickly press and release twice in the same location on the ViewBoard. This is like a double, standard left mouse click.

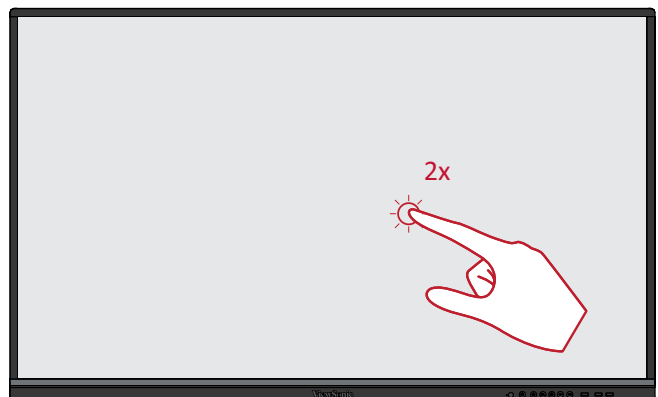

Moving an Object

Press and hold the object on the ViewBoard and slowly drag it with your finger to your desired location.



Erasing Digital Ink

Use your flattened hand, palm, or fist on the ViewBoard and move your hand across the area which you wish to erase.

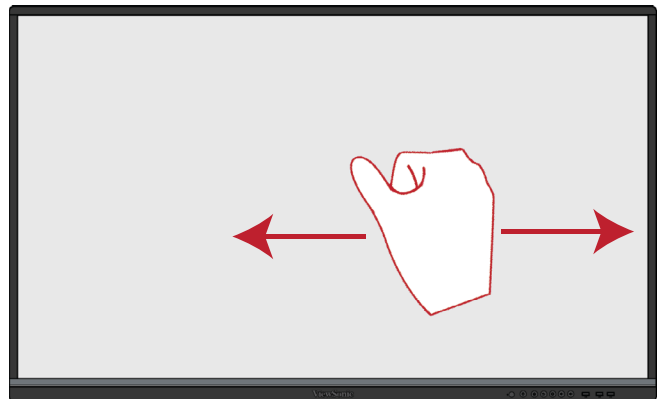

Swipe Up for General Settings

Swipe up from the bottom of the ViewBoard to launch the General Settings.

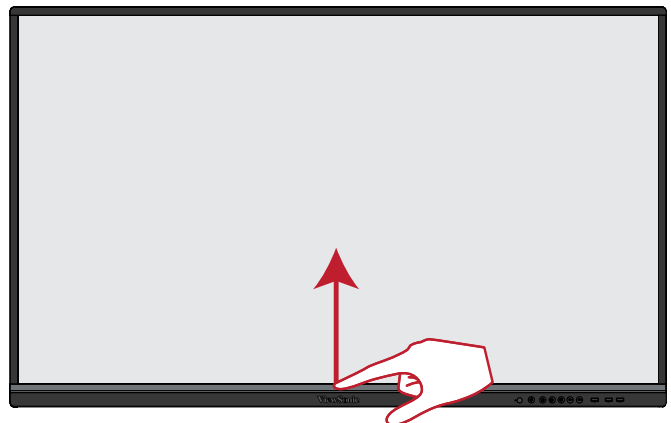

Making Connections

Connecting to Power

1. Connect the power cord to the AC IN jack at the rear of the device.
2. Plug the power cord plug into a power outlet.

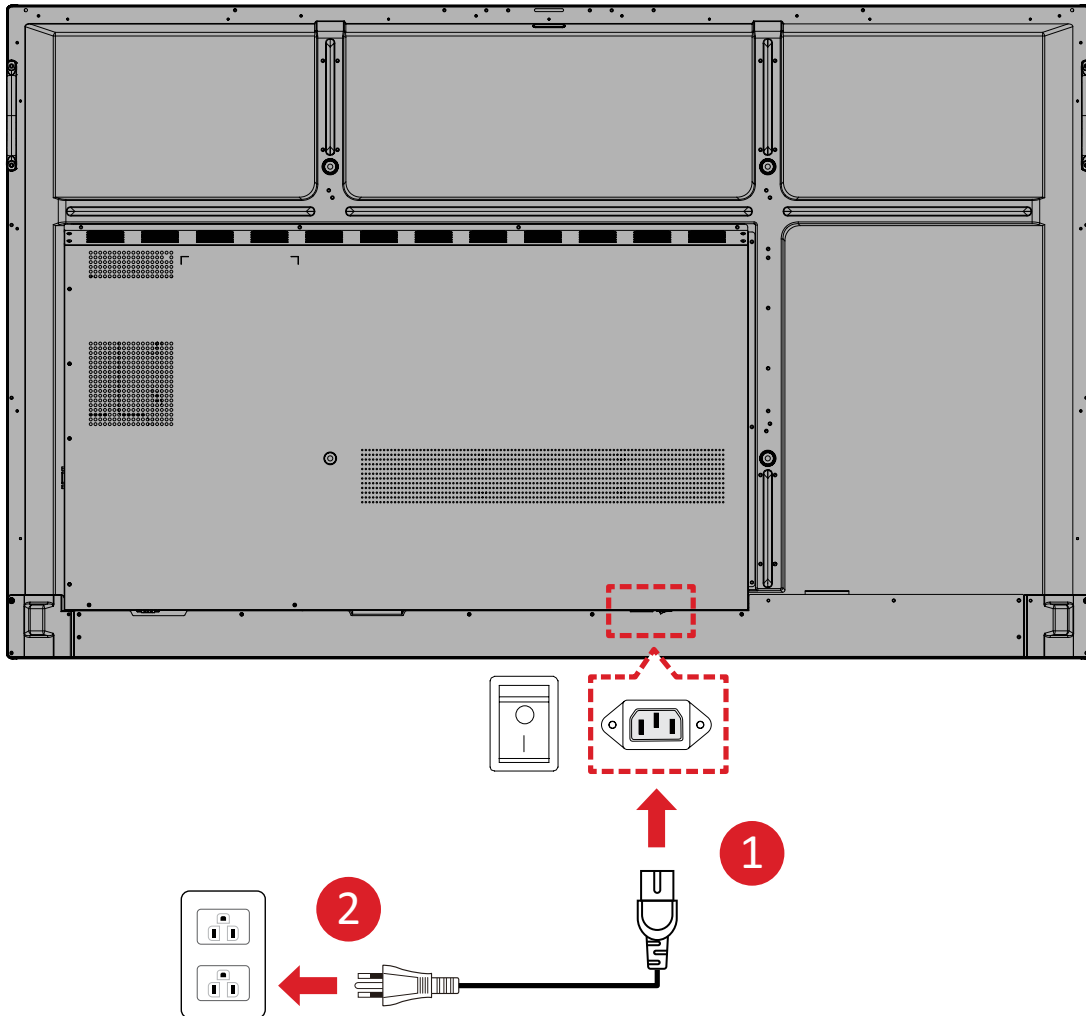

Connecting External Devices and Touch Connection

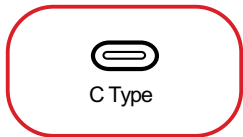

or

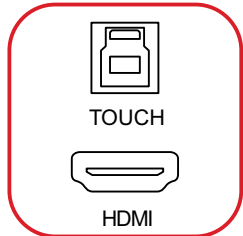

or

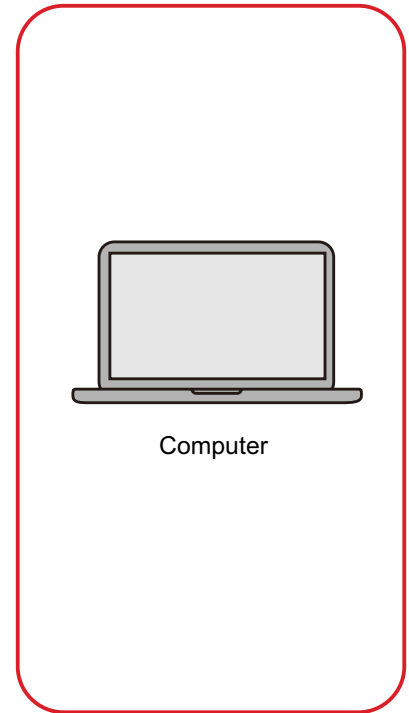
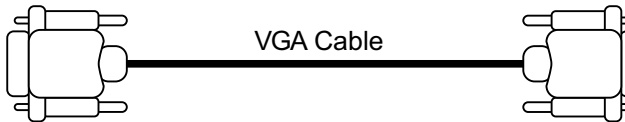
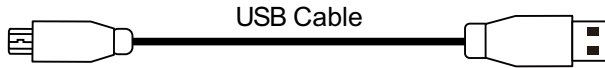
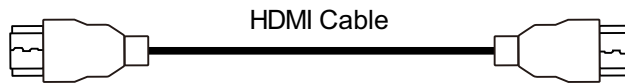
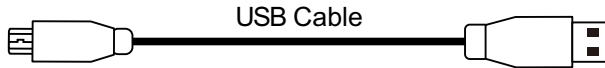
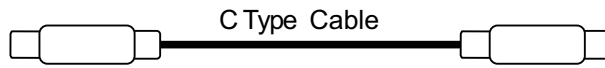

Your external device(s) can be connected in any of the following configurations:

C Type Connection

To connect via C Type:

Connect a C Type cable from your external device to a **C Type** port on the ViewBoard.

HDMI Connection

To connect via HDMI:

1. Connect an HDMI cable from your external device to the **HDMI 1/2/3** port on the ViewBoard.
2. Connect a USB Type B to A to the external device from the appropriate **TOUCH** port of the ViewBoard.

NOTE: The **TOUCH 1** port is for the **HDMI 1** and **VGA** ports. The **TOUCH 2** port is for the **HDMI 2** and **HDMI 3** ports.

VGA Connection

To connect via VGA:

1. Connect a VGA cable from your external device to the **VGA** port on the ViewBoard.
2. Connect a USB Type B to A to the external device from the **TOUCH 2** port of the ViewBoard.

NOTE: The **TOUCH 1** port is for the **HDMI 1** and **VGA** ports. The **TOUCH 2** port is for the **HDMI 2** and **HDMI 3** ports.

RS-232 Connection

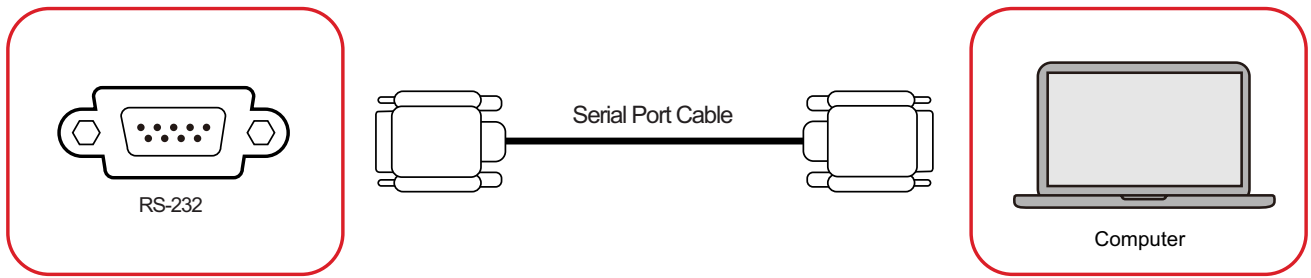

When you use a RS-232 serial port cable to connect your display to an external computer certain functions can be controlled remotely by the PC, including Power ON/OFF, Volume adjustment, Input select, Brightness, and more.

USB and Networking Connections

Just like any PC, it is easy to connect various USB devices and other peripherals to your ViewBoard.

USB Peripherals

Plug the USB device into a **USB** port.

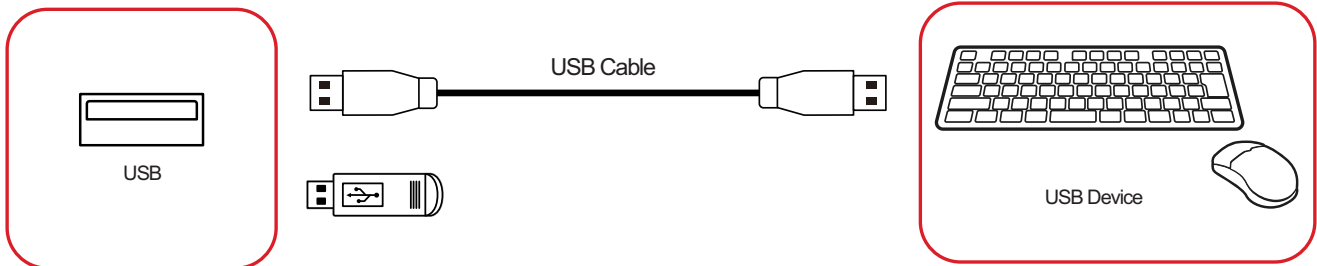

Networking and Modem cables

Plug the network cable into a **LAN** port.

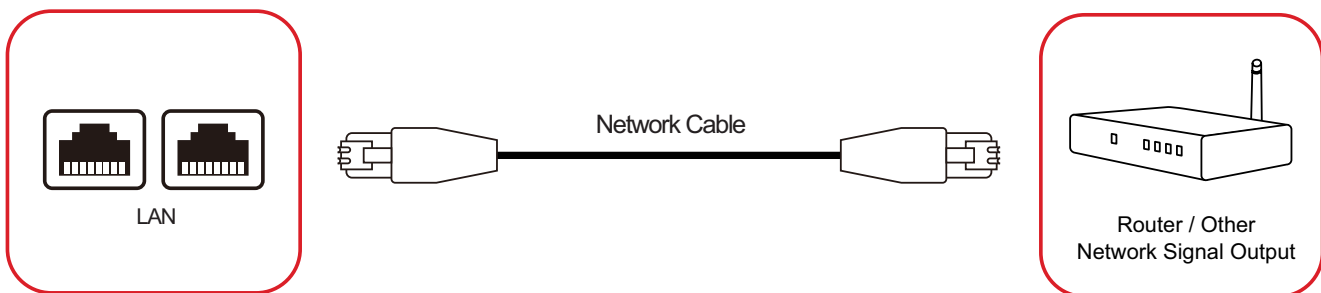

Media Player Connection

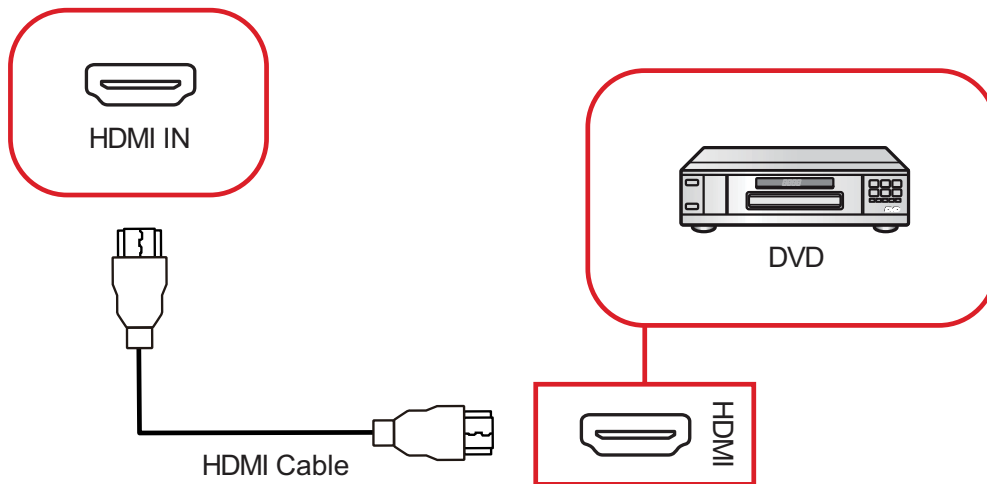

To connect to a media player:

1. Connect the HDMI cable to a **HDMI** port on your ViewBoard and peripheral device.
2. Plug in the power cord of your ViewBoard, and turn on the power supply switch.
3. Press the **Power** button on the ViewBoard to turn the screen on.
4. Press the **INPUT** button on the remote control and switch to the "HDMI" input source.

Audio Connection

The ViewBoard supports **Audio In**, **Audio Out**, and **SPDIF**.

Audio In

To play audio from your external device through the ViewBoard's speakers, connect one end of an audio cable to your external device, and the other end to the ViewBoard's **AUDIO IN** port.

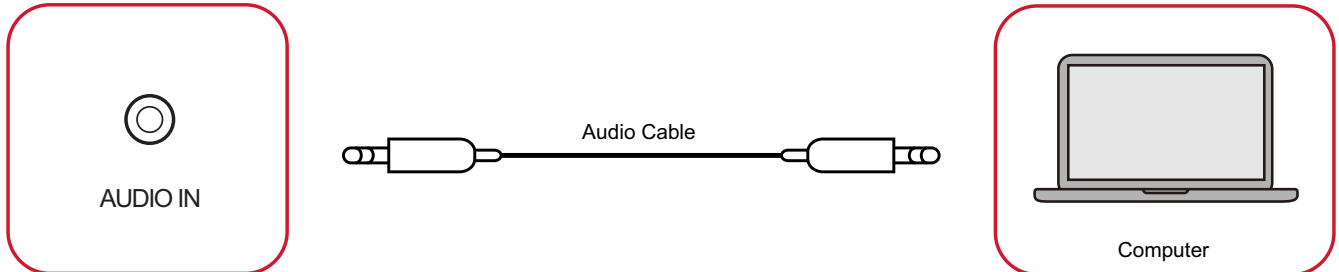

Audio Out

To play audio from the ViewBoard through an external speaker, connect one end of an audio cable to the external speaker, and the other end to the ViewBoard's **AUDIO OUT** port.

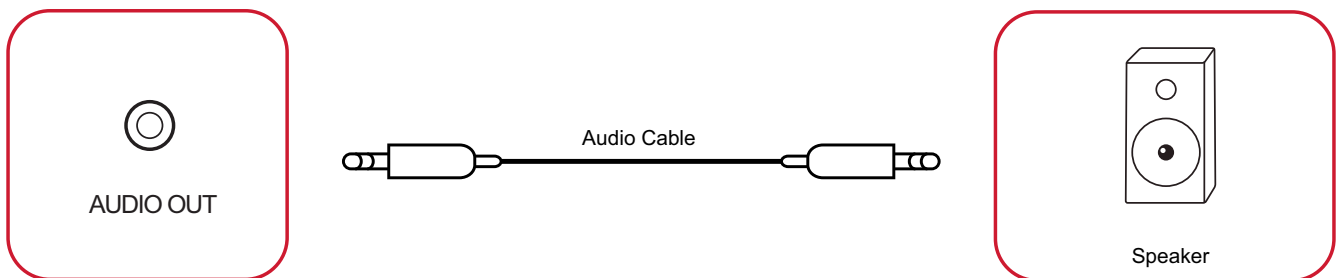

Optional Connections

The ViewBoard comes with an **OPS Slot** for an optional add-on such as a slot-in PC (e.g., VPC-25-O).

Slot-in PC (OPS Slot) Installation

1. Remove the **OPS Slot** cover of the display.

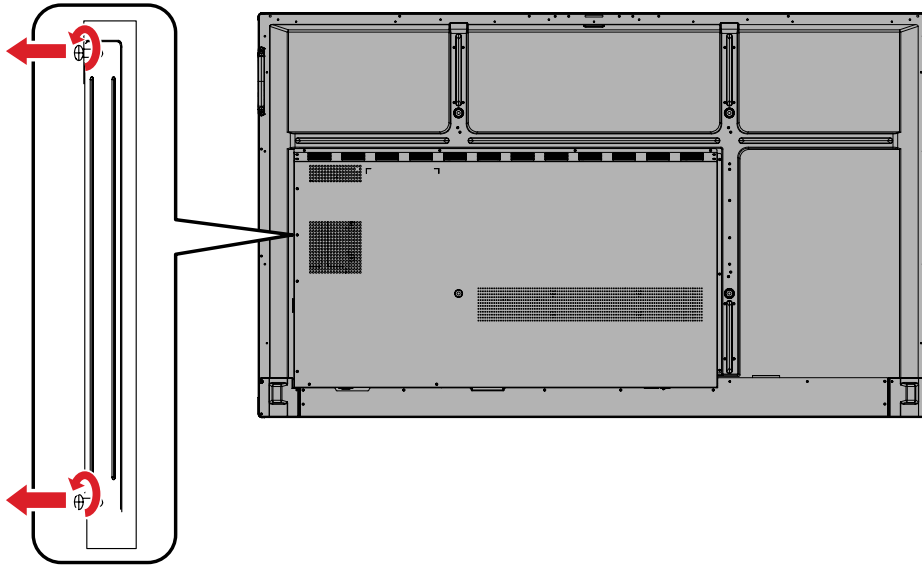

2. Carefully insert the slot-in PC into the **OPS Slot** of the display.

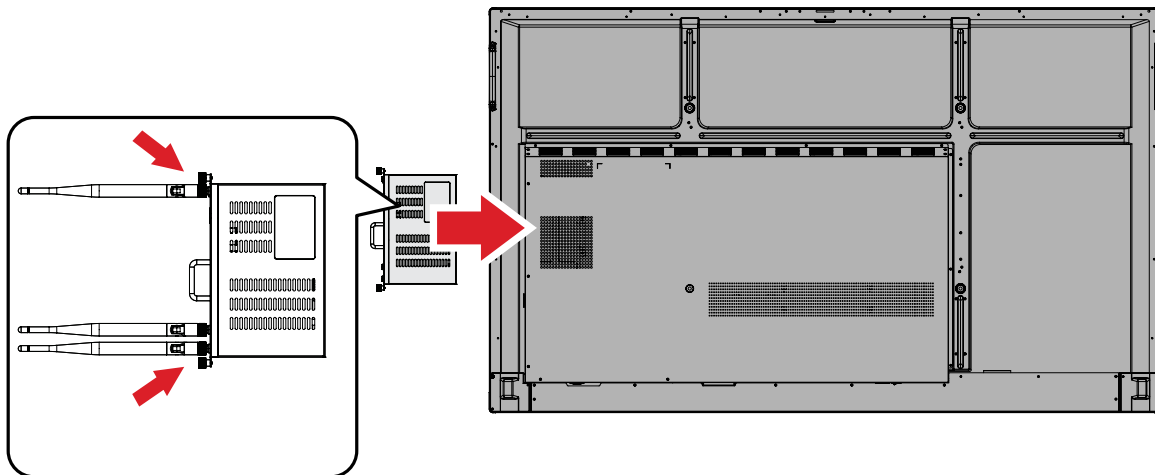

3. Secure the slot-in PC to the display.

Using Your ViewBoard

Powering ON/OFF your ViewBoard

1. Ensure the power cord is connected, plugged into a power outlet, and the **Power Switch** is in the “ON” position.

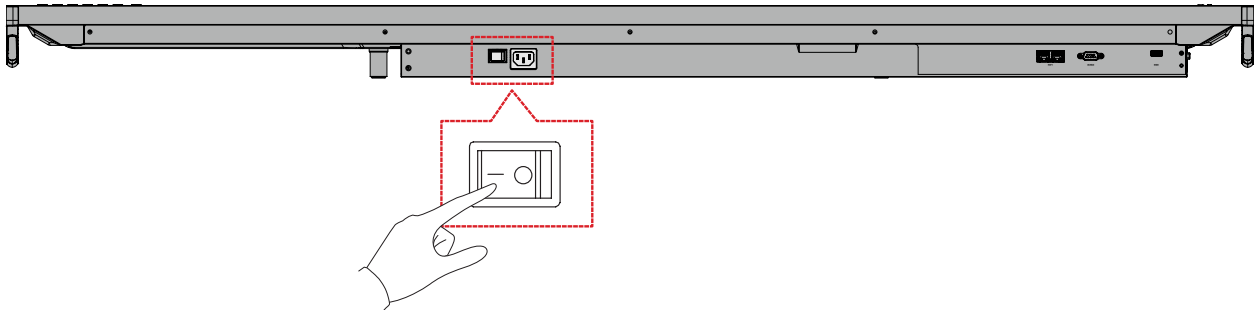

NOTE: The AC Power input and **Power Switch** are located at the bottom of the display.

2. Press the **Power** button to turn ON the ViewBoard.

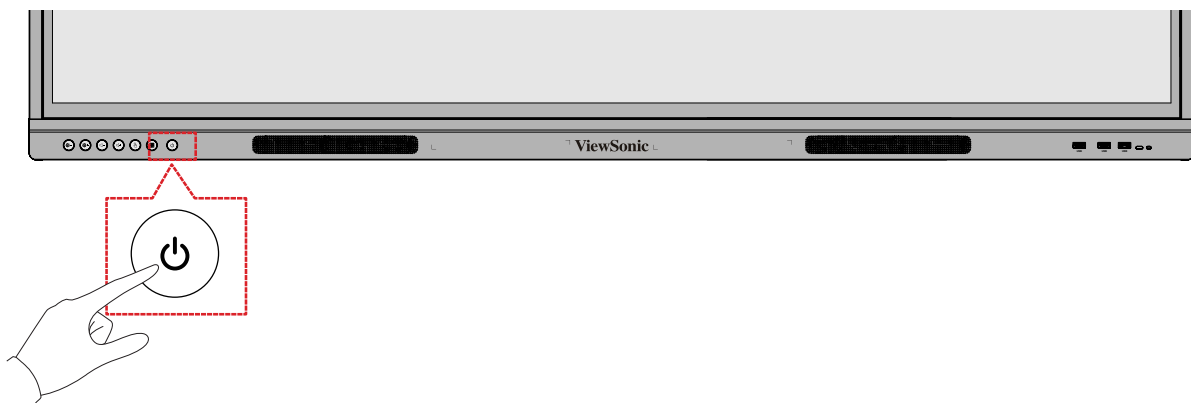

3. To turn the ViewBoard OFF, press and hold the **Power** button.

On-Screen Display (OSD) Menu Tree

Main Menu	Sub-menu	Menu Option	
VGA	H Position	(-/+ , 0~100)	
	V Position	(-/+ , 0~100)	
	Clock	(-/+ , 0~100)	
	Clock Phase	(-/+ , 0~100)	
	Zoom Mode	Full	
		Normal (4:3)	
		Real (1:1)	
		Dynamic (16:9)	
	21:9		
	Auto Adjust	OK	
Screen Reset	Cancel		
	Reset		
Picture	Picture Mode	Normal	
		Dynamic	
		Soft	
		User	
	Contrast	(-/+ , 0~100)	
	Brightness	(-/+ , 0~100)	
	Color	(-/+ , 0~100)	
	Tint	(-/+ , 0~100)	
	Sharpness	(-/+ , 0~100)	
	Color Temperature	Warm (7500K)	
		Normal (9300K)	
		Cool (10000K)	
		User	
	Noise Reduction	Off	
		Low	
		Medium	
		High	
Overscan	Off		
	On		
RGB Range	Full Range		
	Limited Range		
	Auto		

Main Menu	Sub-menu	Menu Option
Picture	Flicker Free	Off
		On
	Blue Light Filter	(-/+ , 0~100)
	Gamma Set	Native
		2.2
		2.4
	Backlight	(-/+ , 0~100)
	Picture Reset	Cancel
Reset		
Audio	Volume Control	Speaker
		Audio Out
		Sync
	Treble	(-/+ , 0~100)
	Bass	(-/+ , 0~100)
	Balance	(-/+ , 0~100)
	Volume	(-/+ , 0~100)
	Maximum Volume	(-/+ , 0~100)
	Minimum Volume	(-/+ , 0~100)
	Mute	Off
		On
	Audio Out Sync	Enable
		Disable
	Audio Out Volume (Line Out)	(-/+ , 0~100)
	Audio Reset	Cancel
Reset		

Main Menu	Sub-menu	Menu Option		
Time	Off Time	Off		
		1 hour~24 hours		
	Date and Time	Set Date		
		Set Time		
		Choose Time Zone		
		Use 24-hour Format		
		Schedule List		
	Schedule	Enable		
		Start Time		
		End Time		
		Input		HDMI 1
				HDMI 2
				HDMI 3
				PC
				Type C
				VGA
		Day of the Week		Day of the Week
	Every Week			
	OSD Turn Off	Off		
		5/15/30/60 seconds		
Input Information	Off			
	5/10/20/30/60 seconds			
Automatic Date & Time	Off			
	On			
Time Reset	Cancel			
	Reset			
About	Display Information	Model Name		
		Serial No.		
		Operation Hours		
		SW Version		

Main Menu	Sub-menu	Menu Option			
Advanced Options	Saving	Panel Saving	Brightness	Off	
				On	
		Power Save	Mode 1		
			Mode 2		
			Mode 3		
			Mode 4		
		Power LED Light	Off		
	On				
	Boot	Boot On Source	HDMI 1		
			HDMI 2		
			HDMI 3		
			PC		
			Type C		
			VGA		
		Boot On Logo	Off		
	On				
	Signal	Auto Signal Detection	Off		
			On		
		No Signal Standby	Off		
			0 mins		
			5 mins		
			15 mins		
			30 mins		
Port	HDMI with One Wire	Off (default)			
		On			
	USB Cloning	Import			
		Export			
	USB Auto Play	Off			
		On			

Main Menu	Sub-menu	Menu Option	
Advanced Options	Others	Switch On State	Power Off
			Forced On
			Last Status
		WOL	Off
			On
		Monitor ID	Monitor ID: 1~98
		OSD Language	
		Factory Reset	Cancel
			Reset
		Advanced Option Reset	Cancel
Reset			
Other Settings	Energy Star	Off	
		On	
	Light Sensor	Off	
		On	
	IP		
	Port		
	Input Source	HDMI 1	
		HDMI 2	
		HDMI 3	
		PC	
		Type C	
		VGA	
	Aspect Ratio	Full	
		Normal (4:3)	
		Real (1:1)	
		Dynamic (16:9)	
		21:9	

On-Screen Display (OSD) Menu Operation

Access **VGA**, **Picture**, **Audio**, **Time**, **About**, **Advanced Options**, and **Other Settings** settings through the OSD Menu.



Open the OSD Menu by pressing **MENU** on the remote control or the **Menu** button () on the front Control Panel.

VGA

NOTE: For VGA input source only.



Item	Description
H Position	Adjust the screen image position horizontally.
V Position	Adjust the screen image position vertically.
Clock	Adjust the frequency of the pixel clock signal. This will affect the resolution and refresh rate.
Clock Phase	Adjust the clock phase to improve the display's clarity and avoid flickering.
Zoom Mode	Select the aspect ratio of the display.
Auto Adjust	Automatically adjust the position of the screen image.
Screen Reset	Reset the Screen settings to their default settings.

Picture

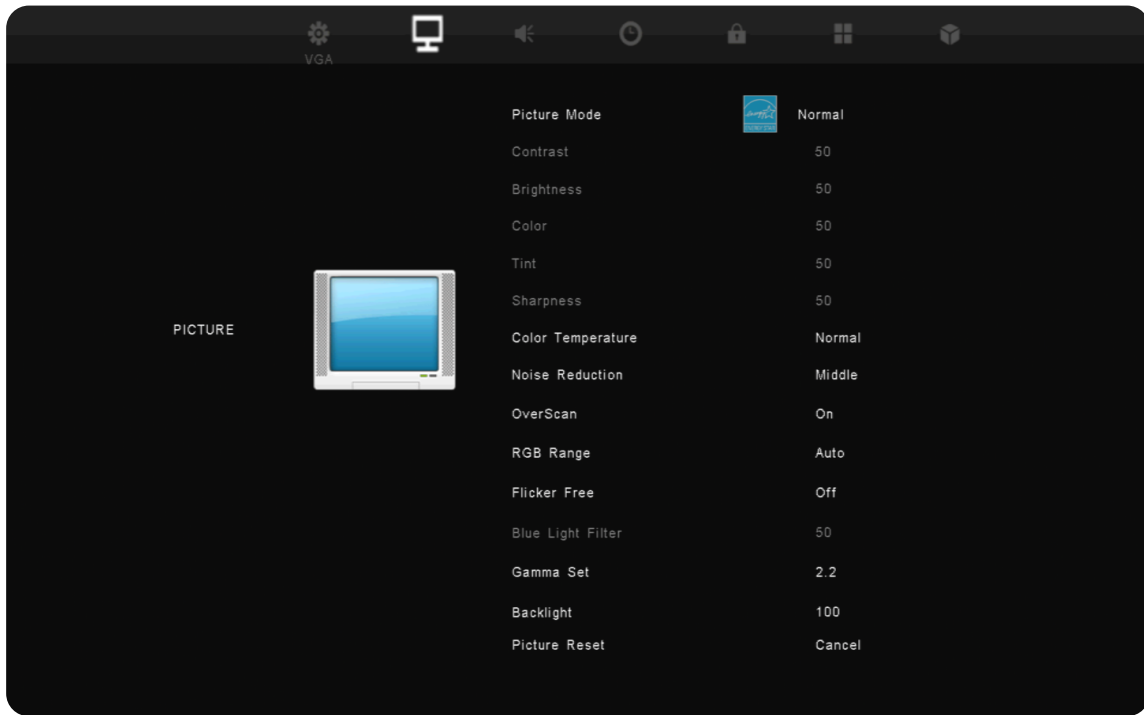

Item	Description										
Picture Mode	Select a predefined picture setting.										
	<table border="1" style="width: 100%; border-collapse: collapse;"> <thead> <tr> <th style="background-color: #ff0000; color: white;">Mode</th> <th style="background-color: #ff0000; color: white;">Description</th> </tr> </thead> <tbody> <tr> <td style="text-align: center;">Normal</td> <td>Default picture mode.</td> </tr> <tr> <td style="text-align: center;">Dynamic</td> <td>Picture will adjust according to the on-screen content.</td> </tr> <tr> <td style="text-align: center;">Soft</td> <td>A high brightness level with lower contrast level.</td> </tr> <tr> <td style="text-align: center;">User</td> <td>User's custom settings.</td> </tr> </tbody> </table>	Mode	Description	Normal	Default picture mode.	Dynamic	Picture will adjust according to the on-screen content.	Soft	A high brightness level with lower contrast level.	User	User's custom settings.
	Mode	Description									
	Normal	Default picture mode.									
	Dynamic	Picture will adjust according to the on-screen content.									
Soft	A high brightness level with lower contrast level.										
User	User's custom settings.										
Contrast	Adjusts the difference between the image background (black level) and the foreground (white level). Use this to set the peak white level after you have previously adjusted the Brightness setting to suit your selected input and viewing environment.										
Brightness	Adjusts background black levels of the screen image. The higher the value, the brighter the image. Lower values will result in a darker image.										
Color	Adjust an image from black and white to fully saturated color.										
Tint	The higher the value, the more greenish the picture becomes. The lower the value, the more reddish the picture becomes.										
Sharpness	A high value results in a sharper picture; a low value softens the picture.										

Item	Description										
<p align="center">Color Temperature</p>	<p>Adjust the color temperature value.</p> <table border="1" data-bbox="491 248 1390 499"> <thead> <tr> <th data-bbox="491 248 703 300">Mode</th> <th data-bbox="703 248 1390 300">Description</th> </tr> </thead> <tbody> <tr> <td data-bbox="491 300 703 351">Warm</td> <td data-bbox="703 300 1390 351">Set the color temperature to 7500K.</td> </tr> <tr> <td data-bbox="491 351 703 403">Normal</td> <td data-bbox="703 351 1390 403">Set the color temperature to 9300K.</td> </tr> <tr> <td data-bbox="491 403 703 454">Cool</td> <td data-bbox="703 403 1390 454">Set the color temperature to 10000K.</td> </tr> <tr> <td data-bbox="491 454 703 499">User</td> <td data-bbox="703 454 1390 499">User's custom settings.</td> </tr> </tbody> </table>	Mode	Description	Warm	Set the color temperature to 7500K.	Normal	Set the color temperature to 9300K.	Cool	Set the color temperature to 10000K.	User	User's custom settings.
	Mode	Description									
	Warm	Set the color temperature to 7500K.									
	Normal	Set the color temperature to 9300K.									
	Cool	Set the color temperature to 10000K.									
User	User's custom settings.										
<p>Noise Reduction</p>	<p>Reduce image noise and distortion.</p>										
<p>Overscan</p>	<p>Automatically enlarge the original picture horizontally and vertically to an equal aspect ratio that fills the screen.</p>										
<p>RGB Range</p>	<p>Manually change the color format options to fit the correct color format range if the colors are not displayed correctly.</p>										
<p>Flicker Free</p>	<p>Reduce or eliminate screen flicker.</p>										
<p>Blue Light Filter</p>	<p>Adjusts the filter that blocks high-energy blue light for a more comfortable viewing experience.</p>										
<p>Gamma Set</p>	<p>Reflects the relationship between input source and picture brightness.</p>										
<p>Backlight</p>	<p>Adjust the backlight value.</p>										
<p>Picture Reset</p>	<p>Reset the Picture settings to their default settings.</p>										

Audio

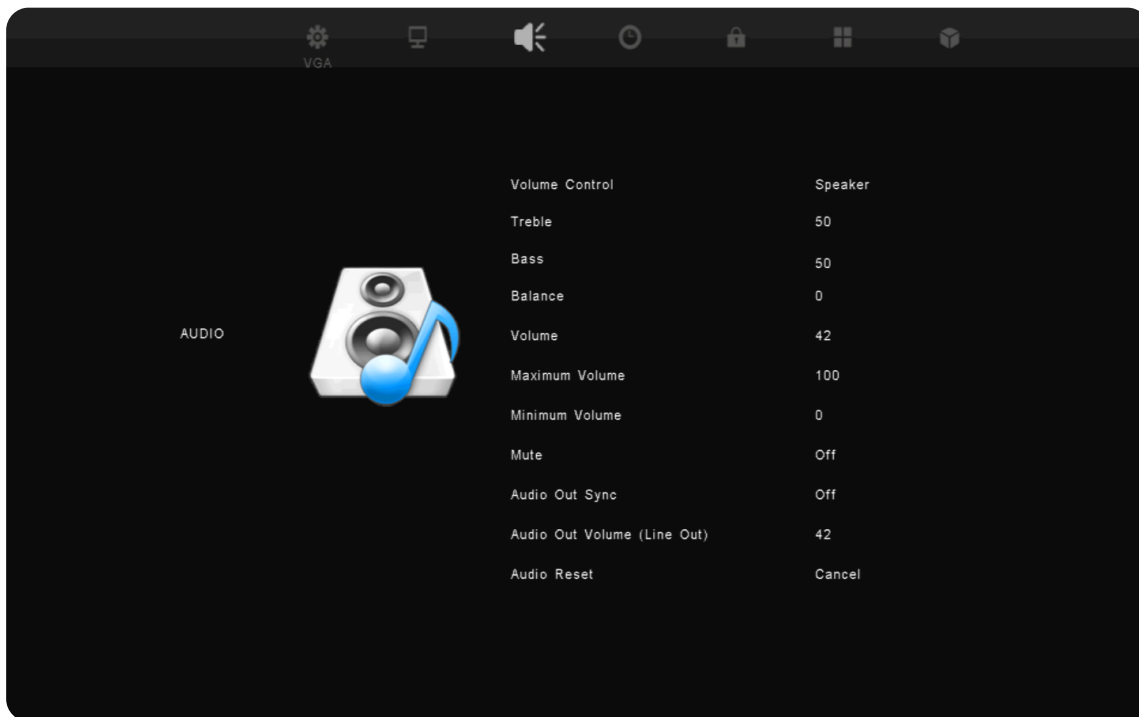

Item	Description								
Volume Control	Select which component has sound and controls the volume.								
	<table border="1"> <thead> <tr> <th>Mode</th> <th>Description</th> </tr> </thead> <tbody> <tr> <td>Speaker</td> <td>Only the display's speakers will have sound and the remote control will control the speakers' volume.</td> </tr> <tr> <td>Audio Out</td> <td>Only Audio Out will have sound and the remote control will control Audio Out's volume.</td> </tr> <tr> <td>Sync</td> <td>Both the Speaker and Audio Out will have sound.</td> </tr> </tbody> </table>	Mode	Description	Speaker	Only the display's speakers will have sound and the remote control will control the speakers' volume.	Audio Out	Only Audio Out will have sound and the remote control will control Audio Out's volume.	Sync	Both the Speaker and Audio Out will have sound.
	Mode	Description							
	Speaker	Only the display's speakers will have sound and the remote control will control the speakers' volume.							
Audio Out	Only Audio Out will have sound and the remote control will control Audio Out's volume.								
Sync	Both the Speaker and Audio Out will have sound.								
Treble	Increase or decrease the treble level (higher-pitched sounds).								
Bass	Increase or decrease the bass level (lower-pitched sounds).								
Balance	Adjust the left/right speaker balance.								
Volume	Increase or decrease the display's volume level.								
Maximum Volume	Set the display's maximum volume level.								
Minimum Volume	Set the display's minimum volume level.								
Mute	Toggle mute on or off.								
Audio Out Sync	Sync the Audio Out Volume (Line Out) with the display's speakers.								
Audio Out Volume (Line Out)	Increase or decrease the Audio Out volume level.								
Audio Reset	Reset the Audio settings to their default settings.								

Time



Item	Description
Off Timer	Set a time for the ViewBoard to automatically power off.
Date and Time	Set the ViewBoard's system time and format.
Schedule	Set up to seven different time intervals for the display to be active.
OSD Turn Off	Set the length of time the OSD Menu remains on screen.
Input Information	Set the length of time the input information will be displayed on the display.
Automatic Date & Time	Automatically set the date and time.
Time Reset	Reset the Time settings to their default settings.

About

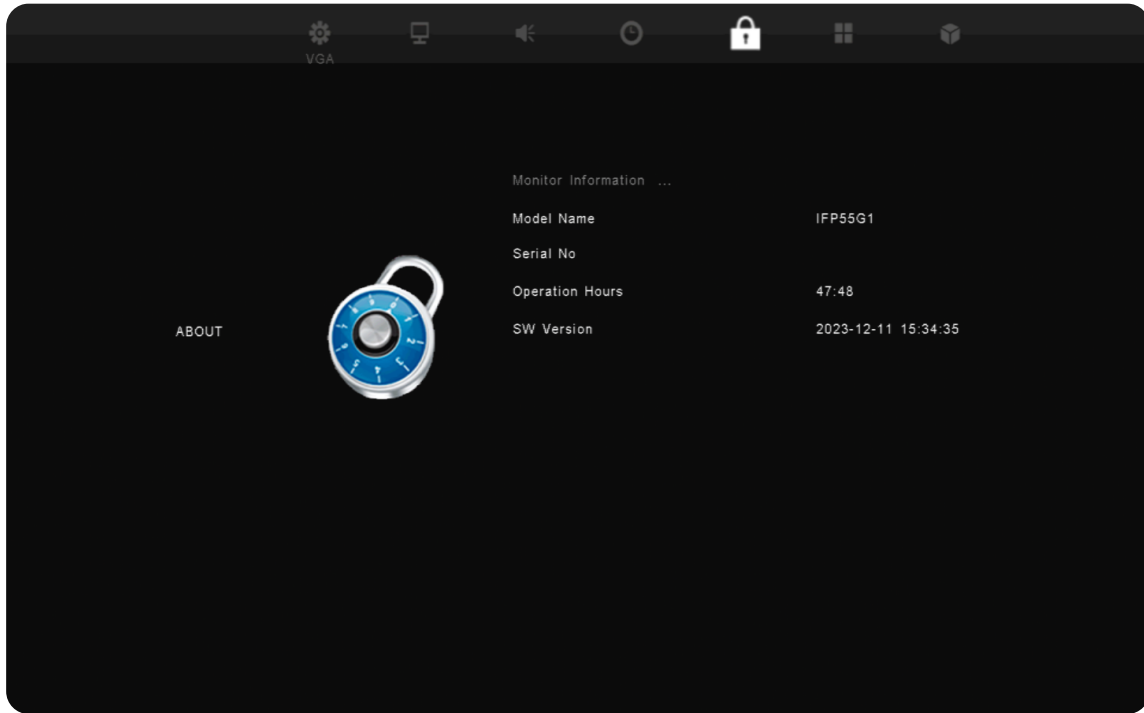

Item	Description
Display Information	See information about the display: Model Name, Serial No., Operation Hours, and Software Version.

Advanced Options

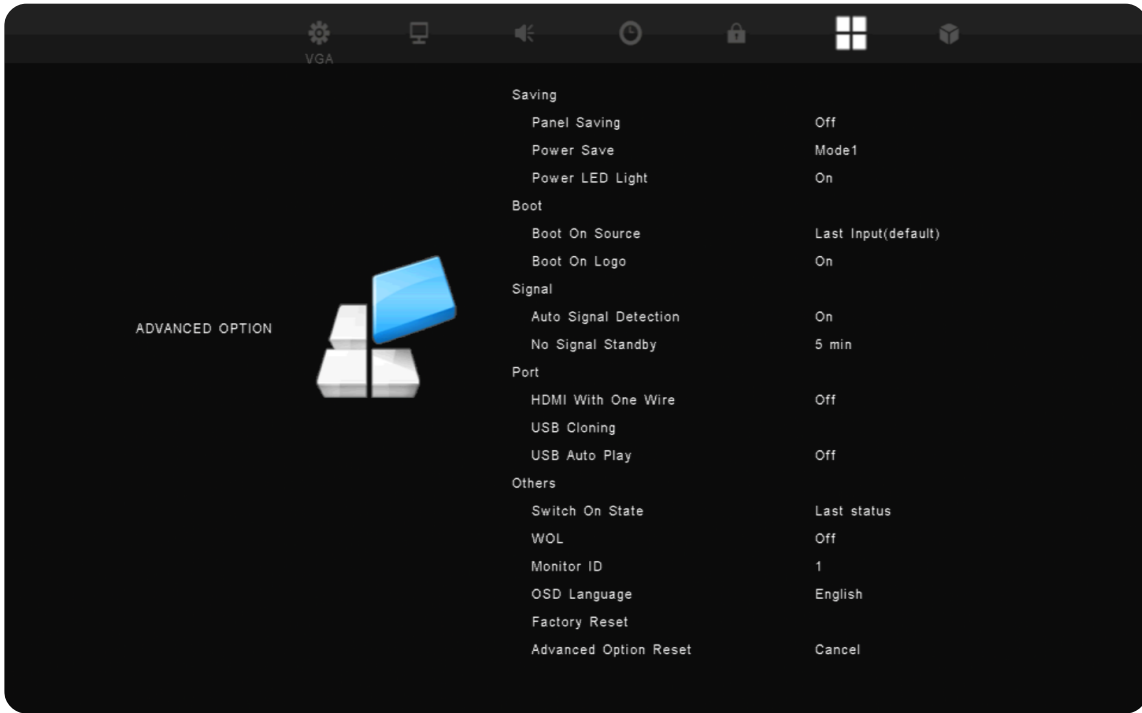

Item	Description										
<p>Saving</p>	<p><u>Panel Saving</u> When enabled, the ViewBoard display’s brightness will be limited to 40% of its maximum brightness level.</p> <p><u>Power Save</u> Select one of the power saving modes to enable power saving.</p> <table border="1" data-bbox="475 1220 1396 1505"> <thead> <tr> <th>Mode</th> <th>Description</th> </tr> </thead> <tbody> <tr> <td>Mode 1</td> <td>TCP off, WOL on.</td> </tr> <tr> <td>Mode 2</td> <td>TCP off, WOL on, wake up by video signal resume.</td> </tr> <tr> <td>Mode 3</td> <td>TCP on, WOL off, wake up by video signal resume.</td> </tr> <tr> <td>Mode 4</td> <td>TCP on, WOL off, no wake up by video signal resume support.</td> </tr> </tbody> </table> <p><u>Power LED Light</u> Turn on/off the ViewBoard’s power indicator light.</p>	Mode	Description	Mode 1	TCP off, WOL on.	Mode 2	TCP off, WOL on, wake up by video signal resume.	Mode 3	TCP on, WOL off, wake up by video signal resume.	Mode 4	TCP on, WOL off, no wake up by video signal resume support.
Mode	Description										
Mode 1	TCP off, WOL on.										
Mode 2	TCP off, WOL on, wake up by video signal resume.										
Mode 3	TCP on, WOL off, wake up by video signal resume.										
Mode 4	TCP on, WOL off, no wake up by video signal resume support.										
<p>Boot</p>	<p><u>Boot On Source</u> Select which input source to use when the Viewboard is powered on.</p> <p><u>Boot On Logo</u> Select a boot up logo to display when the ViewBoard is starting.</p>										

Item	Description								
Signal	<p><u>Auto Signal Detection</u> Enable to automatically detect input sources and display them.</p> <p><u>No Signal Standby</u> Enable to go to standby mode when there is no input source detected.</p>								
Port	<p><u>HDMI with One Wire</u> When ON, HDMI CEC will be enabled. HDMI CEC synchronizes device power on/off operation via HDMI connection.</p> <p><u>USB Cloning</u> Import/export OSD Settings to a USB storage device.</p> <p><u>USB Auto Play</u> When on, the ViewBoard will copy media files from an external storage device (e.g., USB drive) to internal storage, then play the media files automatically.</p>								
Others	<p><u>Switch On State</u> Select the display status for the next time the power cord is connected to a power outlet.</p> <table border="1" data-bbox="475 1003 1394 1330"> <thead> <tr> <th data-bbox="475 1003 699 1055">Mode</th> <th data-bbox="699 1003 1394 1055">Description</th> </tr> </thead> <tbody> <tr> <td data-bbox="475 1055 699 1144">Power Off</td> <td data-bbox="699 1055 1394 1144">The ViewBoard will remain OFF when the power cord is connected.</td> </tr> <tr> <td data-bbox="475 1144 699 1234">Forced On</td> <td data-bbox="699 1144 1394 1234">The ViewBoard will turn ON when the power cord is connected.</td> </tr> <tr> <td data-bbox="475 1234 699 1330">Last Status</td> <td data-bbox="699 1234 1394 1330">The display will return to the previous power status.</td> </tr> </tbody> </table> <p><u>WOL (Wake On LAN)</u> When on, the ViewBoard will turn ON automatically after plugging in a LAN cable when the screen is off.</p> <p><u>Monitor ID</u> Assign a number to remote control the display by RS-232. NOTE: The number range is: 1~98; 99 is reserved for “All Displays”.</p> <p><u>OSD Language</u> Set the preferred language for the ViewBoard.</p> <p><u>Factory Reset</u> Reset all OSD Menu settings to their default settings.</p> <p><u>Advanced Options Reset</u> Reset the Advanced Options settings to their default settings.</p>	Mode	Description	Power Off	The ViewBoard will remain OFF when the power cord is connected.	Forced On	The ViewBoard will turn ON when the power cord is connected.	Last Status	The display will return to the previous power status.
Mode	Description								
Power Off	The ViewBoard will remain OFF when the power cord is connected.								
Forced On	The ViewBoard will turn ON when the power cord is connected.								
Last Status	The display will return to the previous power status.								

Other Settings

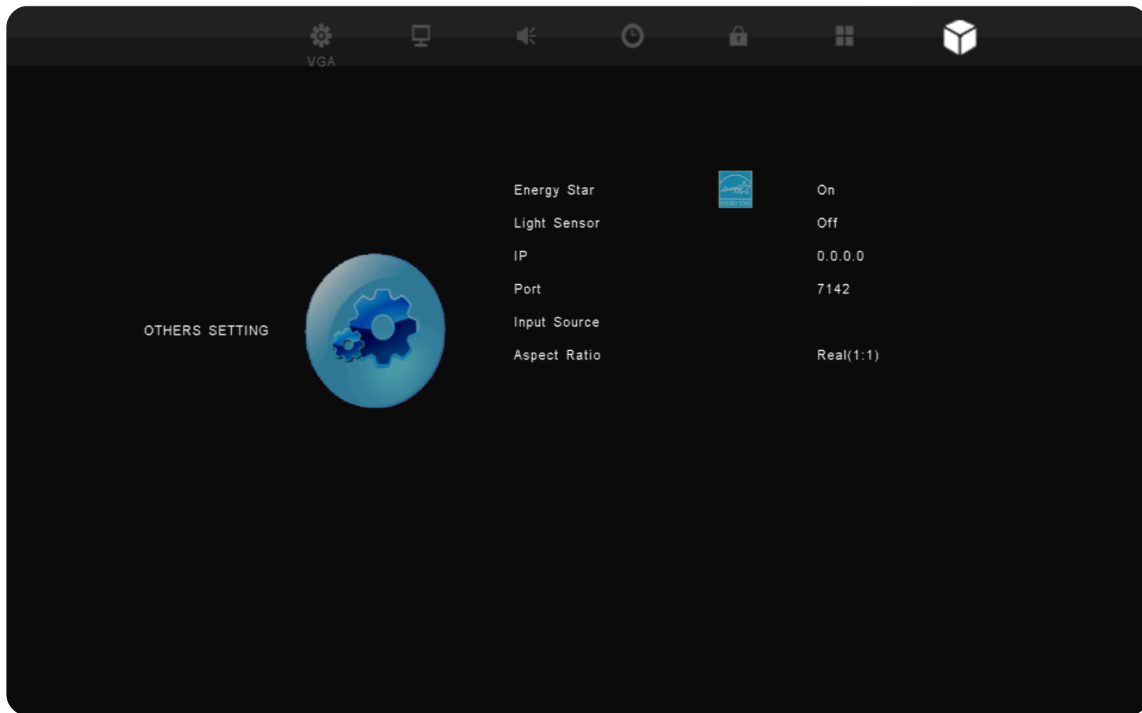

Item	Description
Energy Star	Toggle Energy Star on or off.
Light Sensor	Toggle the light sensor on or off.
IP	View the current IP address.
Port	View the current port number.
Input Source	View the current input source.
Aspect Ratio	See the aspect ratio of the display.

Low Blue Light Filter and Eye Health

The low blue light filter blocks high-energy blue light for a more comfortable viewing experience.

Calculating Breaks

When viewing screens for extended periods, it is recommended to take periodic breaks from viewing. Short breaks of at least 10 minutes are recommended after one (1) hour of continuous viewing.

Taking shorter, more frequent breaks are generally more beneficial than longer, less frequent breaks.

Focus Fatigue (20-20-20 Rule)

To reduce the risk of eye fatigue by constantly looking at the screen, look away from the screen at least every 20 minutes and gaze at a distant object (at least 20 feet away) for at least 20 seconds.

Looking at Distant Objects

While taking breaks, users can further reduce eye strain and dryness by focusing on objects that are further away from them for 10-15 seconds, then gaze at something up close for 10-15 seconds. Repeat this up to 10 times. This exercise reduces the risk of your eyes' focusing ability to "lock up" after prolonged computer work.

Eye and Neck Exercises

Eye Exercises

Eye exercises can help minimize eye strain. Slowly roll your eyes to the left, right, up, and down. Repeat as many times as needed.

Exercises for the eyes

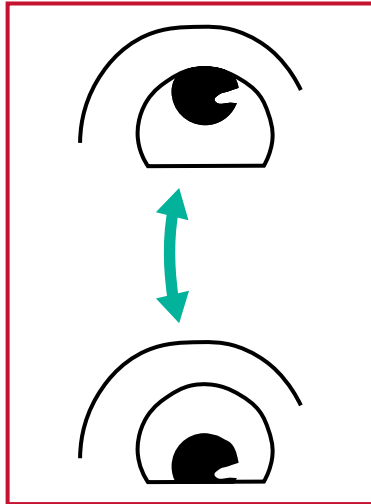

(1) Keep the body and the head upright. Move the eyes up to look at the ceiling, then turn down to look at the floor.

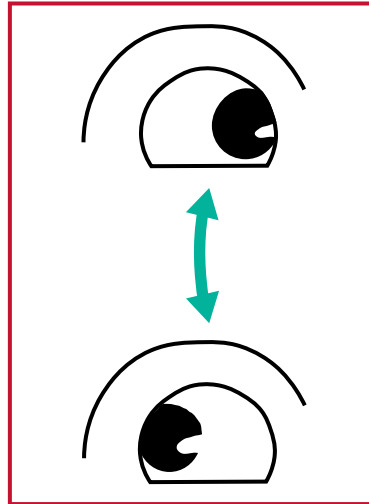

(2) Move the eyes left and right slowly to look at objects on the two sides.

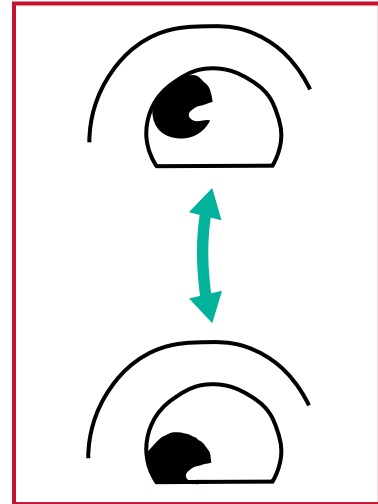

(3) Move the eyes to look at objects at the right upper direction and then right lower direction. Repeat for the left upper and left lower directions.

Neck Exercises

Neck exercises can also help minimize eye strain. Relax your arms and let them hang at your sides, bend forward slightly to stretch the neck, turn your head to the right and to the left. Repeat as many times as needed.

RS-232 Protocol

This document describes the hardware interface spec and software protocols of RS-232 interface communication between ViewSonic LFD and PC or other control units with RS-232 protocol.

The protocol contains three command sections:

- Set-Function
- Get-Function
- Remote control pass-through mode

NOTE: Below, “PC” represents all the control units that can send or receive the RS-232 protocol command.

Description

RS-232 Hardware Specification

ViewSonic LFD communication port on the rear side:

1. Connector type: DSUB 9-Pin Male (female or 3.5 mm barrel connector)
2. Use of crossover (null modem) cable for connection
3. Pin Assignment:

Male DSUB 9-Pin
(preferred)

1 2 3 4 5



6 7 8 9

Female DSUB 9-Pin

5 4 3 2 1



9 8 7 6

3.5 mm barrel connector
(alternative for limited
space)



Pin #	Signal	Remark
1	NC	
2	RXD	Input to Display
3	TXD	Output from Display
4	NC	
5	GND	
6	NC	
7	NC	
8	NC	
9	NC	
frame	GND	

Item	Signal	Remark
Tip	TXD	Output from Display
Ring	RXD	Input to Display
Sleeve	GND	

LAN Hardware Specification

ViewSonic LFD communication port on the rear side:

1. Connector type: 8P8C RJ45
2. Pin Assignment:

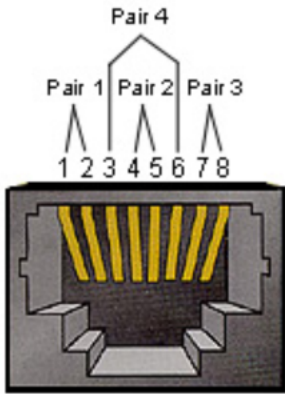

Pin #	Signal	Remark
1	TX+	Output from Display
2	TX-	Output from Display
3	RX+	Input to Display
4	BI_D3+	For 1G case
5	BI_D3-	For 1G case
6	RX-	Input to Display
7	BI_D4+	For 1G case
8	BI_D4-	For 1G case
frame	GND	

RS-232 Communication Setting

- Baud Rate Select: 9600bps (fixed)
- Data bits: 8 bits (fixed)
- Parity: None (fixed)
- Stop Bits: 1 (fixed)

LAN Communication Setting

Type: Ethernet
 Protocol: TCP/IP
 Port: 5000 (fixed)
 WOL Port: 9 (fixed) for UDP*3.2.0
 Cross subnet: No
 Logon Credentials: No

Command Message Reference

PC sends to LFD command packet followed by “CR”. Every time PC sends control command to Display, the Display shall respond as follows:

1. If the message is received correctly it will send “+” (02Bh) followed by “CR” (00Dh)
2. If the message is received incorrectly it will send “-” (02Dh) followed by “CR” (00Dh)

Appendix

Specifications

Item	Category	Specifications			
Model	P/N	IFP55G1	IFP65G1	IFP75G1	IFP86G1
	No.	VS19763	VS19764	VS19765	VS19766
Screen	Size	55"	65"	75"	86"
	Display Area (mm)	1209.6 (H) x 680.4 (V)	1428.48 (H) x 803.52 (V)	1649.66 (H) x 927.94 (V)	1895.04 (H) x 1065.96 (V)
	Surface Treatment	Anti-Glare (Haze 25%), Hard Coating (3H)			
	Brightness	350 nits (Typical)	400 nits (Typical)	400 nits (Typical)	400 nits (Typical)
	Native Resolution	3840 x 2160 (UHD)			
	Touch Point	Windows OS: 40 points; Android: 20 points			
Input Signal		3 x HDMI (HDCP 1.4/2.2; CEC; ARC)			
		1 x VGA			
		1 x Audio In (3.5 mm)			
		1 x RS-232			
		1 x USB C Type (DP v. 1.2; PD 65W; Touch; Data; USB 2.0)			
		2 x USB Type A (2.0)			
		4 x USB Type A (3.0)			
		2 x USB Type B (3.0)			
		1 x RJ45 (LAN-in)			
Output Signal		1 x Audio Out (3.5 mm)			
		1 x RJ45 (LAN-out)			
Network	LAN	10M/100M/1000M (for ViewBoard)			10M/100M (for USB C Type)
PC Slot		10M/100M/1000M (for Slot-in PC)			
Speaker Output		1 x 80-pin OPS			
RS-232		2 x 10W Speaker			
Power	Voltage	RS-232 Communication			
Operating Conditions	Temperature	100V-240V AC 50/60Hz			
	Humidity	32° F to 104° F (0° C to 40° C)			
	Altitude	20%~80% non-condensing			
Storage Conditions	Temperature	≤ 5,000 m			
	Humidity	14° F to 140° F (-10° C to 60° C)			
	Altitude	10%~80% non-condensing			
		≤ 5,000 m			

Item	Category	Specifications			
Dimensions	Physical (mm)	1262.5 x 770 x 85.7	1488 x 896.5 x 85.5	1708 x 1020 x 85.7	1957 x 1160 x 85.7
	Physical (in)	49.7" x 30.3" x 3.37"	58.6" x 35.3" x 3.4"	67.2" x 40.2" x 3.4"	77.0" x 45.7" x 3.4"
Weight	Physical (kg)	26.90 kg	36.95 kg	49.60 kg	62.35 kg
	Physical (lbs)	59.30 lbs	81.46 lbs	109.35 lbs	137.46 lbs
Power Consumption	On (Energy Star)	90.23W	103.8W	110.82W	154.89W
	Off	< 0.5W	< 0.5W	< 0.5W	< 0.5W

NOTE: Product specifications are subject to change without notice.

Display Timing Modes

HDMI

Resolution	Refresh Rate (@)
640 x 480	60 Hz
720 x 400	70 Hz
800 x 600	56, 60 Hz
1024 x 768	60 Hz
1280 x 768	60 Hz
1280 x 800	60 Hz
1280 x 960	60 Hz
1280 x 1024	60 Hz
1360 x 768	60 Hz
1440 x 900	60 Hz
1680 x 1050	60 Hz
1920 x 1080	60 Hz
3840 x 2160	24, 25, 30, 50, 60 Hz

USB C Type

Resolution	Refresh Rate (@)
640 x 480	60 Hz
720 x 400	70 Hz
800 x 600	56, 60 Hz
1024 x 768	60 Hz
1280 x 768	60 Hz
1280 x 800	60 Hz
1280 x 960	60 Hz
1280 x 1024	60 Hz
1360 x 768	60 Hz
1440 x 900	60 Hz
1680 x 1050	60 Hz
1920 x 1080	60 Hz
3840 x 2160	24, 25, 30, 50, 60 Hz

VGA

Resolution	Refresh Rate (@)
640 x 480	60 Hz
800 x 600	56, 60 Hz
1024 x 768	60 Hz
1280 x 768	60 Hz
1280 x 800	60 Hz
1280 x 960	60 Hz
1280 x 1024	60 Hz
1360 x 768	60 Hz
1680 x 1050	60 Hz
1920 x 1080	60 Hz

Troubleshooting

This section describes some common problems that you may experience when using the ViewBoard.

Problem or Issue	Possible Solutions
Remote Control is not working	<ol style="list-style-type: none">1. Check whether something is obstructing the display's remote control receiver.2. Check whether the batteries in the remote control are installed correctly.3. Check whether the batteries need to be replaced.
The unit turns off unexpectedly	<ol style="list-style-type: none">1. Check whether Sleep mode is enabled.2. Check if there is a power outage in your area.3. Turn on the display and see if the problem is with the signal and control system.

PC Mode

Problem or Issue	Possible Solutions
No PC signal	<ol style="list-style-type: none">1. Check the display settings.2. Check the display resolution.3. Adjust the Hs & Vs (synchronization) settings using the OSD menu.
Background streaking	<ol style="list-style-type: none">1. Choose auto adjust.2. Adjust clock and phase.
Unsupported format	<ol style="list-style-type: none">1. Choose auto adjust.2. Adjust clock and phase settings.

Touch Function

Problem or Issue	Possible Solutions
Touch function does not work	<ol style="list-style-type: none">1. Check that drivers are installed correctly.2. Reinstall driver(s).3. Check setup and align it.4. Check whether the touch pen is working properly.

Video Not Working Properly

Problem or Issue	Possible Solutions
No picture/ No sound	<ol style="list-style-type: none">1. Check the Power status.2. Check the signal cable.3. Check that the internal PC is installed correctly.
Picture is unclear or cuts in and out	<ol style="list-style-type: none">1. Check the signal cable.2. Check if other electronics are interrupting the signal.
Poor picture	<ol style="list-style-type: none">1. Adjust chroma, brightness, and contrast settings in the menu.2. Check the signal cable.

Audio Not Working Properly

Problem or Issue	Possible Solutions
No sound	<ol style="list-style-type: none">1. Press the Mute/Unmute button.2. Adjust the volume.3. Check the audio cable.
One speaker only	<ol style="list-style-type: none">1. Adjust the sound balance in the menu.2. Check the sound control panel settings of the computer.3. Check the audio cable.

Maintenance

General Precautions

- Make sure the device is turned off and the power cable is unplugged from the power outlet.
- Never spray or pour any liquid directly onto the screen or case.
- Handle the device with care, as a darker-colored device, if scuffed, may show marks more clearly than a lighter-colored device.
- Do not use the system continuously for long periods of time.

Cleaning the Screen

- Wipe the screen with a clean, soft, lint-free cloth. This removes dust and other particles.
- If the screen is still not clean, apply a small amount of non-ammonia, non-alcohol based glass cleaner onto a clean, soft, lint-free cloth; then wipe the screen.

Cleaning the Case

- Use a soft, dry cloth.
- If the case is still not clean, apply a small amount of non-ammonia, non-alcohol based, mild non-abrasive detergent onto a clean, soft, lint-free cloth, then wipe the surface.

Disclaimer

- ViewSonic® does not recommend the use of any ammonia or alcohol-based cleaners on the display screen or case. Some chemical cleaners have been reported to damage the screen and/or case of the device.
- ViewSonic® will not be liable for damage resulting from use of any ammonia or alcohol-based cleaners.

NOTE: If condensation appears between the glass and the panel, keep the display turned on until the moisture disappears.

Regulatory and Service Information

Compliance Information

This section addresses all connected requirements and statements regarding regulations. Confirmed corresponding applications shall refer to nameplate labels and relevant markings on the unit.

FCC Compliance Statement

This device complies with part 15 of FCC Rules. Operation is subject to the following two conditions: (1) this device may not cause harmful interference, and (2) this device must accept any interference received, including interference that may cause undesired operation. This equipment has been tested and found to comply with the limits for a Class B digital device, pursuant to part 15 of the FCC Rules.

These limits are designed to provide reasonable protection against harmful interference in a residential installation. This equipment generates, uses, and can radiate radio frequency energy, and if not installed and used in accordance with the instructions, may cause harmful interference to radio communications. However, there is no guarantee that interference will not occur in a particular installation. If this equipment does cause harmful interference to radio or television reception, which can be determined by turning the equipment off and on, the user is encouraged to try to correct the interference by one or more of the following measures:

- Reorient or relocate the receiving antenna.
- Increase the separation between the equipment and receiver.
- Connect the equipment into an outlet on a circuit different from that to which the receiver is connected.
- Consult the dealer or an experienced radio/TV technician for help.

Warning: You are cautioned that changes or modifications not expressly approved by the party responsible for compliance could void your authority to operate the equipment.

Industry Canada Statement

CAN ICES-003(B) / NMB-003(B)

CE Conformity for European Countries



The device complies with the EMC Directive 2014/30/EU and Low Voltage Directive 2014/35/EU.

The following information is only for EU-member states:

The mark shown to the right is in compliance with the Waste Electrical and Electronic Equipment Directive 2012/19/EU (WEEE). The mark indicates the requirement NOT to dispose of the equipment as unsorted municipal waste, but use the return and collection systems according to local law.



Declaration of RoHS2 Compliance

This product has been designed and manufactured in compliance with Directive 2011/65/EU of the European Parliament and the Council on restriction of the use of certain hazardous substances in electrical and electronic equipment (RoHS2 Directive) and is deemed to comply with the maximum concentration values issued by the European Technical Adaptation Committee (TAC) as shown below:

Substance	Proposed Maximum Concentration	Actual Concentration
Lead (Pb)	0.1%	< 0.1%
Mercury (Hg)	0.1%	< 0.1%
Cadmium (Cd)	0.01%	< 0.01%
Hexavalent Chromium (Cr6 ⁺)	0.1%	< 0.1%
Polybrominated biphenyls (PBB)	0.1%	< 0.1%
Polybrominated diphenyl ethers (PBDE)	0.1%	< 0.1%
Bis (2-ethylhexyl) phthalate (DEHP)	0.1%	< 0.1%
Butyl benzyl phthalate (BBP)	0.1%	< 0.1%
Dibutyl phthalate (DBP)	0.1%	< 0.1%
Diisobutyl phthalate (DIBP)	0.1%	< 0.1%

Certain components of products as stated above are exempted under the Annex III of the RoHS2 Directives as noted below:

- Copper alloy containing up to 4% lead by weight.
- Lead in high melting temperature type solders (i.e. lead-based alloys containing 85% by weight or more lead).
- Electrical and electronic components containing lead in a glass or ceramic other than dielectric ceramic in capacitors, e.g. piezoelectronic devices, or in a glass or ceramic matrix compound.
- Lead in dielectric ceramic in capacitors for a rated voltage of 125V AC or 250V DC or higher.

ENERGY STAR Statement

ENERGY STAR is a U.S. Environmental Protection Agency voluntary program that helps businesses and individuals save money and protect our climate through superior energy efficiency. Products that earn the ENERGY STAR prevent greenhouse gas emissions by meeting strict energy efficiency criteria or requirements set by the U.S. Environmental Protection Agency.

As an ENERGY STAR Partner, ViewSonic is determined to meet the Energy star Guidelines and mark all certified models with the ENERGY STAR logo.

The following logo appears on all ENERGY STAR-certified models:



NOTE: The power management features significantly reduce energy consumption when the product is not in use. Power management allows the device to automatically enter a low power “sleep” mode after a defined period of inactivity. And the power management features also enter Sleep Mode or Off Mode within 5 minutes of being disconnected from a host computer. Please note any change in energy settings will increase energy consumption.

Indian Restriction of Hazardous Substances

Restriction on Hazardous Substances statement (India). This product complies with the “India E-waste Rule 2011” and prohibits use of lead, mercury, hexavalent chromium, polybrominated biphenyls or polybrominated diphenyl ethers in concentrations exceeding 0.1 weight % and 0.01 weight % for cadmium, except for the exemptions set in Schedule 2 of the Rule.

Product Disposal at End of Product Life

ViewSonic® respects the environment and is committed to working and living green. Thank you for being part of Smarter, Greener Computing. Please visit the ViewSonic® website to learn more.

USA & Canada:

<https://www.viewsonic.com/us/go-green-with-viewsonic>

Europe:

<https://www.viewsonic.com/eu/go-green-with-viewsonic>

Taiwan:

<https://recycle.epa.gov.tw/>

Copyright Information

Copyright© ViewSonic® Corporation, 2024. All rights reserved.

Macintosh and Power Macintosh are registered trademarks of Apple Inc.

Microsoft, Windows, and the Windows logo are registered trademarks of Microsoft Corporation in the United States and other countries.

ViewSonic® and the three birds logo are registered trademarks of ViewSonic® Corporation.

VESA is a registered trademark of the Video Electronics Standards Association. DPMS, DisplayPort, and DDC are trademarks of VESA.

ENERGY STAR® is a registered trademark of the U.S. Environmental Protection Agency (EPA).

As an ENERGY STAR® partner, ViewSonic® Corporation has determined that this product meets the ENERGY STAR® guidelines for energy efficiency.

Disclaimer: ViewSonic® Corporation shall not be liable for technical or editorial errors or omissions contained herein; nor for incidental or consequential damages resulting from furnishing this material, or the performance or use of this product.

In the interest of continuing product improvement, ViewSonic® Corporation reserves the right to change product specifications without notice. Information in this document may change without notice.

No part of this document may be copied, reproduced, or transmitted by any means, for any purpose without prior written permission from ViewSonic® Corporation.

Customer Service

For technical support or product service, see the table below or contact your reseller.

NOTE: You will need the product's serial number.

Country/ Region	Website	Country/ Region	Website
Asia Pacific & Africa			
Australia	www.viewsonic.com/au/	Bangladesh	www.viewsonic.com/bd/
中国 (China)	www.viewsonic.com.cn	香港 (繁體中文)	www.viewsonic.com/hk/
Hong Kong (English)	www.viewsonic.com/hk-en/	India	www.viewsonic.com/in/
Indonesia	www.viewsonic.com/id/	Israel	www.viewsonic.com/il/
日本 (Japan)	www.viewsonic.com/jp/	Korea	www.viewsonic.com/kr/
Malaysia	www.viewsonic.com/my/	Middle East	www.viewsonic.com/me/
Myanmar	www.viewsonic.com/mm/	Nepal	www.viewsonic.com/np/
New Zealand	www.viewsonic.com/nz/	Pakistan	www.viewsonic.com/pk/
Philippines	www.viewsonic.com/ph/	Singapore	www.viewsonic.com/sg/
臺灣 (Taiwan)	www.viewsonic.com/tw/	ประเทศไทย	www.viewsonic.com/th/
Việt Nam	www.viewsonic.com/vn/	South Africa & Mauritius	www.viewsonic.com/za/
Americas			
United States	www.viewsonic.com/us	Canada	www.viewsonic.com/us
Latin America	www.viewsonic.com/la		
Europe			
Europe	www.viewsonic.com/eu/	France	www.viewsonic.com/fr/
Deutschland	www.viewsonic.com/de/	Қазақстан	www.viewsonic.com/kz/
Россия	www.viewsonic.com/ru/	España	www.viewsonic.com/es/
Türkiye	www.viewsonic.com/tr/	Україна	www.viewsonic.com/ua/
United Kingdom	www.viewsonic.com/uk/		

Limited Warranty

ViewSonic® Smart White Board

What the warranty covers:

ViewSonic® warrants its products to be free from defects in material and workmanship during the warranty period. If a product proves to be defective in material or workmanship during the warranty period, ViewSonic® will, at its sole option, and as your sole remedy, repair or replace the product with a similar product. Replacement Product or parts may include remanufactured or refurbished parts or components. The repair or replacement unit or parts or components will be covered by the balance of the time remaining on the customer's original limited warranty and the warranty period will not be extended. ViewSonic® provides no warranty for any third-party software whether included with the product or installed by the customer, installation of any unauthorized hardware parts or components (e.g. Projector Lamps). (Please refer to: "What the warranty excludes and does not cover" section).

Who the warranty protects:

This warranty is valid only for the first consumer purchaser.

What the warranty excludes and does not cover:

- Any product on which the serial number has been defaced, modified, or removed.
- Damage, deterioration, or malfunction resulting from:
 - » Accident, misuse, neglect, fire, water, lightning, or other acts of nature, unauthorized product modification, or failure to follow instructions supplied with the product.
 - » Repair or attempted repair by anyone not authorized by ViewSonic®.
 - » Damage to or loss of any programs, data, or removable storage media.
 - » Normal wear and tear.
 - » Removal or installation of the product.
- Software or data loss occurring during repair or replacement.
- Any damage of the product due to shipment.
- Causes external to the product, such as electric power fluctuations or failure.
- Use of supplies or parts not meeting ViewSonic's specifications.
- Failure of owner to perform periodic product maintenance as stated in the User Guide.

- Any other cause which does not relate to a product defect.
- Damage caused by static (non-moving) images displayed for lengthy periods of time (also referred to as image burn-in).
- Software - Any third-party software included with the product or installed by the customer.
- Hardware/Accessories/Parts/Components – Installation of any unauthorized hardware, accessories, consumable parts or components (e.g. Projector Lamps).
- Damage to, or abuse of, the coating on the surface of the display through inappropriate cleaning as described in the product User Guide.
- Removal, installation, and set-up service charges, including wall-mounting of the product.

How to get service:

- For information about receiving service under warranty, contact ViewSonic® Customer Support (Please refer to the “Customer Service” page). You will need to provide your product’s serial number.
- To obtain warranty service, you will be required to provide: (a) the original dated sales slip, (b) your name, (c) your address, (d) a description of the problem, and (e) the serial number of the product.
- Take or ship the product, freight prepaid, in the original container to an authorized ViewSonic® service center or ViewSonic®.
- For additional information or the name of the nearest ViewSonic® service center, contact ViewSonic®.

Limitation of implied warranties:

There are no warranties, express or implied, which extend beyond the description contained herein including the implied warranty of merchantability and fitness for a particular purpose.

Exclusion of damages:

ViewSonic's liability is limited to the cost of repair or replacement of the product. ViewSonic® shall not be liable for:

- Damage to other property caused by any defects in the product, damages based upon inconvenience, loss of use of the product, loss of time, loss of profits, loss of business opportunity, loss of goodwill, interference with business relationships, or other commercial loss, even if advised of the possibility of such damages.
- Any other damages, whether incidental, consequential or otherwise.
- Any claim against the customer by any other party.
- Repair or attempted repair by anyone not authorized by ViewSonic®.

Effect of state law:

This warranty gives you specific legal rights, and you may also have other rights which vary from state to state. Some states do not allow limitations on implied warranties and/or do not allow the exclusion of incidental or consequential damages, so the above limitations and exclusions may not apply to you.

Sales outside the U.S.A. and Canada:

For warranty information and service on ViewSonic® products sold outside of the U.S.A. and Canada, contact ViewSonic® or your local ViewSonic® dealer.

The warranty period for this product in mainland China (Hong Kong, Macao, and Taiwan Excluded) is subject to the terms and conditions of the Maintenance Guarantee Card.

For users in Europe and Russia, full details of warranty provided can be found at: <http://www.viewsonic.com/eu/> under "Support/Warranty Information".

Mexico Limited Warranty

ViewSonic® Smart White Board

What the warranty covers:

ViewSonic® warrants its products to be free from defects in material and workmanship, under normal use, during the warranty period. If a product proves to be defective in material or workmanship during the warranty period, ViewSonic® will, at its sole option, repair or replace the product with a like product. Replacement product or parts may include remanufactured or refurbished parts or components & accessories.

Who the warranty protects:

This warranty is valid only for the first consumer purchaser.

What the warranty excludes and does not cover:

- Any product on which the serial number has been defaced, modified or removed.
- Damage, deterioration, or malfunction resulting from:
 - » Accident, misuse, neglect, fire, water, lightning, or other acts of nature, unauthorized product modification, unauthorized attempted repair, or failure to follow instructions supplied with the product.
 - » Causes external to the product, such as electrical power fluctuations or failure.
 - » Use of supplies or parts not meeting ViewSonic®'s specifications.
 - » Normal wear and tear.
 - » Any other cause which does not relate to a product defect.
- Any product exhibiting a condition commonly known as “image burn-in” which results when a static image is displayed on the product for an extended period of time.
- Removal, installation, insurance, and set-up service charges.

How to get service:

For information about receiving service under warranty, contact ViewSonic® Customer Support (Please refer to the attached “Customer Service” page). You will need to provide your product’s serial number, so please record the product information in the space provided below on your purchase for your future use. Please retain your receipt of proof of purchase to support your warranty claim.

For Your Records

Product Name: _____ Model Number: _____
Document Number: _____ Serial Number: _____
Purchase Date: _____ Extended Warranty Purchase? _____(Y/N)
If so, what date does warranty expire? _____

- To obtain warranty service, you will be required to provide (a) the original dated sales slip, (b) your name, (c) your address, (d) a description of the problem, and (e) the serial number of the product.
- Take or ship the product, in the original container packaging, to an authorized ViewSonic® service center.
- Round trip transportation costs for in-warranty products will be paid by ViewSonic®.

Limitation of implied warranties:

There are no warranties, express or implied, which extend beyond the description contained herein including the implied warranty of merchantability and fitness for a particular purpose.

Exclusion of damages:

ViewSonic®’s liability is limited to the cost of repair or replacement of the product. ViewSonic® shall not be liable for:

- Damage to other property caused by any defects in the product, damages based upon inconvenience, loss of use of the product, loss of time, loss of profits, loss of business opportunity, loss of goodwill, interference with business relationships, or other commercial loss, even if advised of the possibility of such damages.
- Any other damages, whether incidental, consequential or otherwise.
- Any claim against the customer by any other party.
- Repair or attempted repair by anyone not authorized by ViewSonic®.

Contact Information for Sales & Authorized Service (Centro Autorizado de Servicio) within Mexico:	
Name, address, of manufacturer and importers: México, Av. de la Palma #8 Piso 2 Despacho 203, Corporativo Interpalmas, Col. San Fernando Huixquilucan, Estado de México Tel: (55) 3605-1099 http://www.viewsonic.com/la/soporte/index.htm	
NÚMERO GRATIS DE ASISTENCIA TÉCNICA PARA TODO MÉXICO: 001.866.823.2004	
Hermosillo: Distribuciones y Servicios Computacionales SA de CV. Calle Juarez 284 local 2 Col. Bugambilias C.P: 83140 Tel: 01-66-22-14-9005 E-Mail: disc2@hmo.megared.net.mx	Villahermosa: Compumantenimientos Garantizados, S.A. de C.V. AV. GREGORIO MENDEZ #1504 COL, FLORIDA C.P. 86040 Tel: 01 (993) 3 52 00 47 / 3522074 / 3 52 20 09 E-Mail: compumantenimientos@prodigy.net.mx
Puebla, Pue. (Matriz): RENTA Y DATOS, S.A. DE C.V. Domicilio: 29 SUR 721 COL. LA PAZ 72160 PUEBLA, PUE. Tel: 01(52).222.891.55.77 CON 10 LINEAS E-Mail: datos@puebla.megared.net.mx	Veracruz, Ver.: CONEXION Y DESARROLLO, S.A DE C.V. Av. Americas # 419 ENTRE PINZÓN Y ALVARADO Fracc. Reforma C.P. 91919 Tel: 01-22-91-00-31-67 E-Mail: gacosta@qplus.com.mx
Chihuahua: Soluciones Globales en Computación C. Magisterio # 3321 Col. Magisterial Chihuahua, Chih. Tel: 4136954 E-Mail: Cefeo@soluglobales.com	Cuernavaca: Compusupport de Cuernavaca SA de CV Francisco Leyva # 178 Col. Miguel Hidalgo C.P. 62040, Cuernavaca Morelos Tel: 01 777 3180579 / 01 777 3124014 E-Mail: aquevedo@compusupportcva.com
Distrito Federal: QPLUS, S.A. de C.V. Av. Coyoacán 931 Col. Del Valle 03100, México, D.F. Tel: 01(52)55-50-00-27-35 E-Mail : gacosta@qplus.com.mx	Guadalajara, Jal.: SERVICRECE, S.A. de C.V. Av. Niños Héroes # 2281 Col. Arcos Sur, Sector Juárez 44170, Guadalajara, Jalisco Tel: 01(52)33-36-15-15-43 E-Mail: mmiranda@servicrece.com
Guerrero Acapulco: GS Computación (Grupo Sesicomp) Progreso #6-A, Colo Centro 39300 Acapulco, Guerrero Tel: 744-48-32627	Monterrey: Global Product Services Mar Caribe # 1987, Esquina con Golfo Pérsico Fracc. Bernardo Reyes, CP 64280 Monterrey N.L. México Tel: 8129-5103 E-Mail: aydeem@gps1.com.mx
MERIDA: ELECTROSER Av Reforma No. 403Gx39 y 41 Mérida, Yucatán, México CP97000 Tel: (52) 999-925-1916 E-Mail: rrrb@sureste.com	Oaxaca, Oax.: CENTRO DE DISTRIBUCION Y SERVICIO, S.A. de C.V. Murguía # 708 P.A., Col. Centro, 68000, Oaxaca Tel: 01(52)95-15-15-22-22 Fax: 01(52)95-15-13-67-00 E-Mail: gpotai2001@hotmail.com
Tijuana: STD Av Ferrocarril Sonora #3780 L-C Col 20 de Noviembr Tijuana, Mexico	FOR USA SUPPORT: ViewSonic® Corporation 381 Brea Canyon Road, Walnut, CA. 91789 USA Tel: 800-688-6688 E-Mail: http://www.viewsonic.com



ViewSonic®