

Lenovo 100w Gen 4/Lenovo 300w Yoga Gen 4/Lenovo 500w Yoga Gen 4 User Guide



Read this first

Before using this documentation and the product it supports, ensure that you read and understand the following:

- *Safety and Warranty Guide*
- *Setup Guide*
- [Generic Safety and Compliance Notices](#)

Third Edition (June 2024)

© Copyright Lenovo 2023, 2024.

LIMITED AND RESTRICTED RIGHTS NOTICE: If data or software is delivered pursuant to a General Services Administration "GSA" contract, use, reproduction, or disclosure is subject to restrictions set forth in Contract No. GS-35F-05925.

Contents

Discover your Lenovo notebook.iii

Chapter 1. Meet your computer. 1

Front	1
Base	3
Side	4
Bottom	6
Specifications	7
USB specifications.	7

Chapter 2. Get started with your computer. 9

Access networks	9
Connect to Wi-Fi networks.	9
Connect to a cellular network (for selected models of Lenovo 300w Yoga Gen 4 only).	9
Turn on the Airplane mode.	10
Interact with your computer	10
Use hotkeys	10
Use the touch screen (for Lenovo 300w Yoga Gen 4 and Lenovo 500w Yoga Gen 4 only)	12
Connect to an external display	13
Get to know YOGA modes (for Lenovo 300w Yoga Gen 4 and Lenovo 500w Yoga Gen 4 only)	14
Use Lenovo Integrated Pen (for selected models of Lenovo 300w Yoga Gen 4 and Lenovo 500w Yoga Gen 4)	15

Chapter 3. Explore your computer 17

Lock the computer	17
Lenovo Commercial Vantage	17
Manage power	18
Check the battery status	18
Charge the computer	18
Change the power settings	19
Transfer data	19
Set up a Bluetooth connection	19

Chapter 4. Configure advanced settings. 21

UEFI BIOS setup utility	21
Enter the UEFI BIOS setup utility	21
Change the startup sequence	21

Change the hotkey mode	21
Enable or disable the Always On USB function	21
Use passwords	21
Password types	21
Set an administrator password	22
Change or remove the administrator password	22
Set a user password	22
Change or remove the user password	23
Enable the power on password	23
Set a hard disk password	23
Change or remove the hard disk password	23
Install a Windows operating system and drivers	24
Use firewalls and antivirus programs.	25

Chapter 5. CRU replacement 27

CRU list	27
Disable Fast Startup and the built-in battery.	27
Replace a CRU	28
Pen dummy (for selected models of Lenovo 300w Yoga Gen 4 and Lenovo 500w Yoga Gen 4).	28
Keyboard	29
Base cover assembly	32
M.2 solid-state drive (for selected models)	34
Wireless WAN module (for selected models of 300w Yoga Gen 4 only)	36

Chapter 6. Help and support 39

Frequently asked questions	39
Self-help resources	40
Windows label	41
Call Lenovo	41
Before you contact Lenovo	41
Lenovo Customer Support Center.	42

Appendix A. Compliance information. 45

Appendix B. Notices and trademarks. 49

Discover your Lenovo notebook

Thank you for choosing a Lenovo® notebook! We are dedicated to delivering the best solution to you.

Before starting your tour, please read the following information:

- Illustrations in this documentation might look different from your product.
- Depending on the model, some optional accessories, features, software programs, and user interface instructions might not be applicable to your computer.
- Documentation content is subject to change without notice. To get the latest documentation, go to <https://pcsupport.lenovo.com>.

Chapter 1. Meet your computer

Front

Lenovo 100w Gen 4







Lenovo 300w Yoga Gen 4



Lenovo 500w Yoga Gen 4



Item	Description	Item	Description
	Camera		Webcam privacy shutter
	Microphone		Touch screen



Webcam privacy shutter

Slide the webcam privacy shutter to cover or uncover the camera lens. It is designed to protect your privacy.



Note: The location of microphones may vary on Lenovo 500w Yoga Gen 4.

Related topics

- “Use the touch screen (for Lenovo 300w Yoga Gen 4 and Lenovo 500w Yoga Gen 4 only)” on page 12

Base









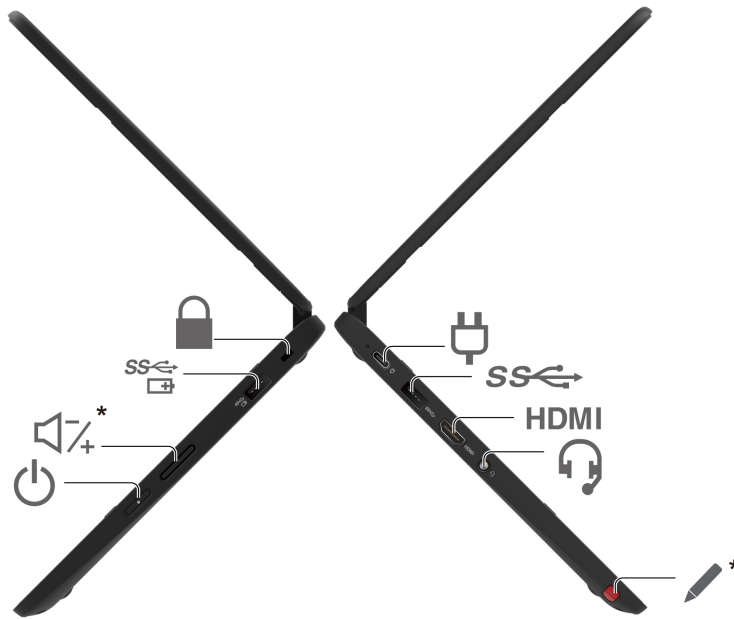

Item	Description	Item	Description
	Camera (for selected models of Lenovo 300w Yoga Gen 4 and Lenovo 500w Yoga Gen 4)		Microphone
	Trackpad		

* for selected models

Side



Item	Description	Item	Description
	USB-C® (3.2 Gen 2) power connector		USB-A 3.2 Gen 1 connector
HDMI	HDMI™ connector		Audio connector
	Lenovo Integrated Pen (for selected models of Lenovo 300w Yoga Gen 4 and Lenovo 500w Yoga Gen 4)		Power button
	Volume button (for Lenovo 300w Yoga Gen 4 and Lenovo 500w Yoga Gen 4 only)		Always On USB-A 3.2 Gen 1 connector
	Security-lock slot		

* for selected models

Statement on USB transfer rate

Depending on many factors such as the processing capability of the host and peripheral devices, file attributes, and other factors related to system configuration and operating environments, the actual transfer rate using the various USB connectors on this device will vary and will be slower than the data rate listed below for each corresponding device.

USB device	Data rate (Gbit/s)
3.2 Gen 1	5
3.2 Gen 2	10



USB device	Data rate (Gbit/s)
3.2 Gen 2 × 2	20
4 Gen 2 × 2	20
4 Gen 3 × 2	40
Thunderbolt 3	40
Thunderbolt 4	40

Related topics

- “USB specifications” on page 7
- “Connect to an external display” on page 13
- “Use Lenovo Integrated Pen (for selected models of Lenovo 300w Yoga Gen 4 and Lenovo 500w Yoga Gen 4)” on page 15
- “Lock the computer” on page 17
- “Charge the computer” on page 18

Bottom



Item	Description	Item	Description
	Keyboard drainage hole		Speakers

Keyboard drainage hole

Drain out liquid from your computer if you accidentally spill liquid on the keyboard.

CAUTION:

When the computer is operating, it should be placed on a hard and flat surface with its bottom area not in contact with user's bare skin. Under normal operating conditions, the temperature of the bottom surface will remain within an acceptable range as defined in IEC 62368-1, but such temperatures can still be high enough to cause discomfort or harm to the user if directly touched for over one minute at a time. As such, it is recommended that users avoid prolonged direct contact with the bottom of the computer.

Note: Some Lenovo computers include a display that can be rotated 360 degrees. When those products are used as a tablet computer, the temperatures of all the accessible parts are within an acceptable range as defined in IEC 62368-1.

Specifications

Specifications	Description
Memory	<ul style="list-style-type: none"> • Low Power Double Data Rate 5 (LPDDR5), soldered on board, 4 GB or 8 GB
Storage device	<ul style="list-style-type: none"> • Lenovo 100w Gen 4: <ul style="list-style-type: none"> – Universal Flash Storage (UFS)*, 128 GB – 2242 M.2 solid-state drive*, 128 GB • Lenovo 300w Yoga Gen 4 / Lenovo 500w Yoga Gen 4: <ul style="list-style-type: none"> – UFS*, 128 GB – 2242 M.2 solid-state drive*, 128 GB or 256 GB
Audio	<ul style="list-style-type: none"> • Dolby Audio™
Display	<ul style="list-style-type: none"> • Display technology: <ul style="list-style-type: none"> – Lenovo 100w Gen 4 : Twisted Nematic (TN) – Lenovo 300w Yoga Gen 4: In-Plane Switching (IPS), anti-fingerprint treatment – Lenovo 500w Yoga Gen 4: Widescreen Ultra eXtended Graphics Array (WUXGA) • Display ratio: <ul style="list-style-type: none"> – Lenovo 100w Gen 4 / Lenovo 300w Yoga Gen 4: 16:9 – Lenovo 500w Yoga Gen 4: 16:10 • Display resolution: <ul style="list-style-type: none"> – Lenovo 100w Gen 4 / Lenovo 300w Yoga Gen 4: 1366 x 768 pixels – Lenovo 500w Yoga Gen 4: 1920 x 1200 pixels • Multi-touch technology (for Lenovo 300w Yoga Gen 4 and Lenovo 500w Yoga Gen 4 only)
Security features	<ul style="list-style-type: none"> • Trusted Platform Module (TPM) (for selected models)
Wireless features	<ul style="list-style-type: none"> • Bluetooth • Wireless LAN • Wireless WAN (4G) (for selected models of Lenovo 300w Yoga Gen 4) <p>Note: The 4G cellular service is provided by authorized mobile service carriers in some countries or regions. You must have a cellular plan from a service carrier to connect to the cellular network. The cellular data plan might vary by location.</p>

* for selected models

USB specifications

Note: Depending on the model, some USB connectors might not be available on your computer.

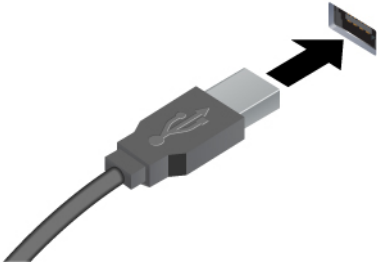
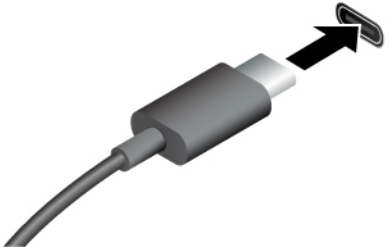
Connector name	Description
 <p data-bbox="168 558 496 585">• USB-A 3.2 Gen 1 connector</p>	<p data-bbox="680 380 1380 436">Connect USB-compatible devices, such as a USB keyboard, USB mouse, USB storage device, or USB printer.</p>
 <p data-bbox="168 926 509 953">• USB-C (3.2 Gen 2) connector</p>	<ul data-bbox="680 653 1380 926" style="list-style-type: none"><li data-bbox="680 653 1380 709">• Charge USB-C compatible devices with the output voltage and current of 5 V and 3 A.<li data-bbox="680 720 1380 831">• Connect to an external display:<ul data-bbox="711 762 1380 831" style="list-style-type: none"><li data-bbox="711 762 1380 789">– USB-C to VGA: up to 1920 x 1200 pixels, 60 Hz<li data-bbox="711 800 1380 831">– USB-C to DP: up to 4096 x 2304 pixels, 60 Hz<li data-bbox="680 842 1380 926">• Connect to USB-C accessories to help expand your computer functionality. To purchase USB-C accessories, go to <a data-bbox="711 873 1347 926" href="https://www.lenovo.com/accessories">https://www.lenovo.com/accessories.

Chapter 2. Get started with your computer

Access networks

This section helps you connect to a wireless or wired network.

Connect to Wi-Fi networks

Click the network icon in the Windows® notification area, and then select a network for connection. Provide required information, if needed.

- For models with Windows 10:

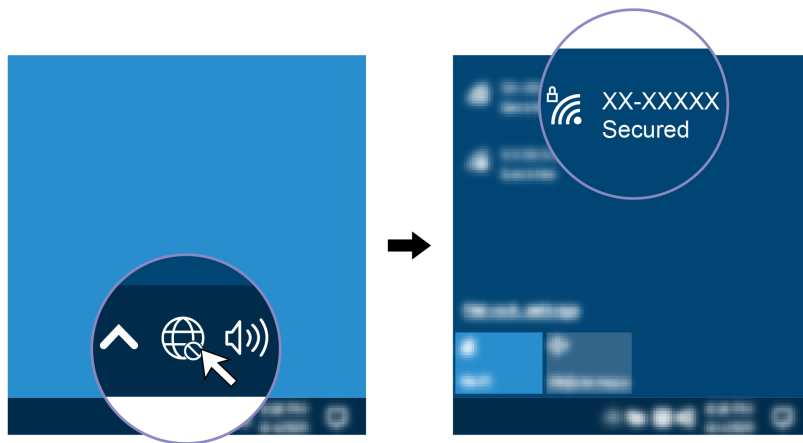

- For models with Windows 11:

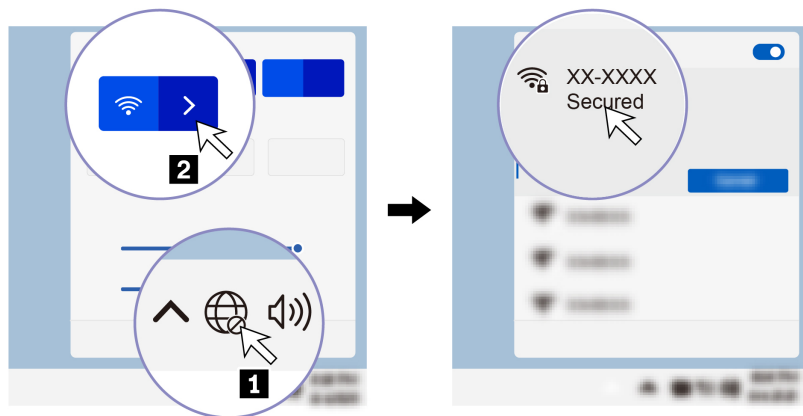

Connect to a cellular network (for selected models of Lenovo 300w Yoga Gen 4 only)

To connect a 4G cellular data network, you must have a wireless wide area network (WWAN) module and a nano-SIM card installed. You can purchase a nano-SIM card from authorized service carriers.

Notes:

- The 4G cellular service is provided by authorized mobile service carriers in some countries or regions. You must have a cellular plan from a service carrier to connect to the cellular network. The cellular data plan might vary by location.
- Network connection speeds might also vary by location, environment, network conditions and other factors.

To establish a cellular connection:

1. Turn off the computer and remove the base cover assembly. See “Base cover assembly” on page 32.
2. Slide the socket cover slightly to the left and pivot the socket cover upward. Install a nano-SIM card and close the socket cover. Then slide the socket cover slightly to the right and ensure that the card is seated correctly.

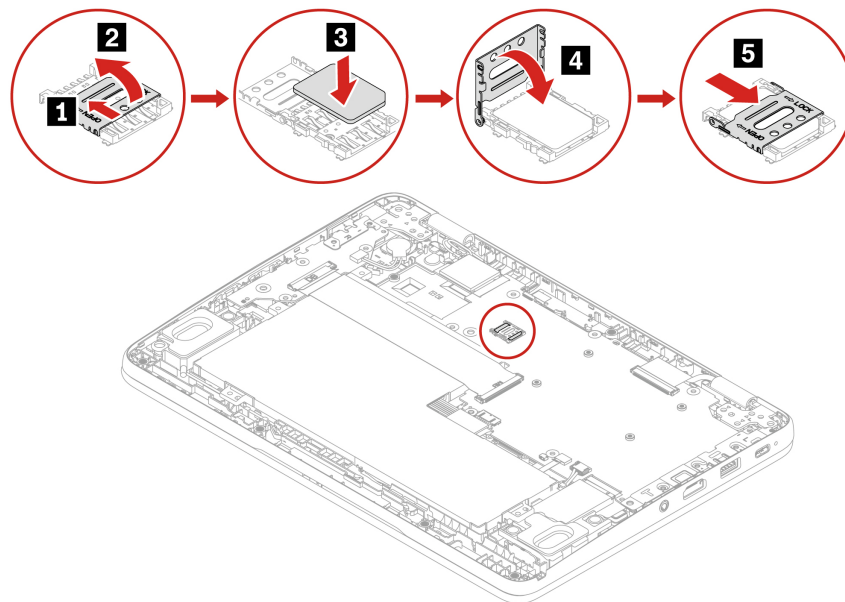

3. Turn on the computer.
4. Click the network icon, and then select the cellular network icon  from the list. Provide required information, if needed.

Turn on the Airplane mode

When the Airplane mode is enabled, all wireless features are disabled.











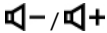

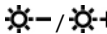
1. Type Airplane mode in the Windows search box and then press Enter.
2. Turn on the Airplane mode.

Interact with your computer

Your computer provides you various ways to navigate the screen.

Use hotkeys

Some keys on the keyboard are printed with icons. These keys are called hotkeys and can be pressed alone or in combination with the Fn key to access certain functions or settings quickly. The functions of hotkeys are symbolized by the icons printed on them.

Hotkey / hotkey combination	Function
	Mute / unmute the speakers. If you mute the speakers and turn off your computer, the speakers remain muted when you turn on your computer.
 - / 	Decrease / increase the volume.
	Mute / unmute the microphones.
 - / 	Decrease / increase display brightness.
	Manage external displays.
	Turn on / turn off the airplane mode.
	Open the Settings window.
	Lock the current user account.
	View open program windows.
	Open the Windows Calculator.
	Open the Lenovo Commercial Vantage app. Note: This hotkey does not work on Windows 11 SE.
	Open the Windows snipping tool.
Fn+ 	Equal the Home key.

Use the hotkey mode

Some hotkeys share keys with functions keys (F1 to F12). The hotkey mode is a UEFI BIOS setting that changes how hotkeys (or function keys) are used.

- When the hotkey mode is enabled, press Fn together with the hotkey to use the hotkey.
- When the hotkey mode is disabled, press the hotkey directly.

Important note for Lenovo 300w Yoga Gen 4 / Lenovo 500w Yoga Gen 4

Do not place your computer on another computer while it is in use. Otherwise, the keyboard and the trackpad will be disabled.

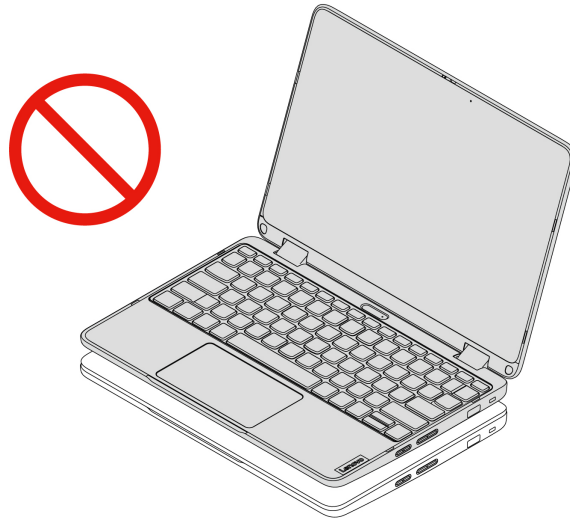

Use the touch screen (for Lenovo 300w Yoga Gen 4 and Lenovo 500w Yoga Gen 4 only)

If your computer display supports the multi-touch function, you can navigate the screen with simple touch gestures. For more touch gestures, refer to <https://support.microsoft.com/windows>.

Note: Some gestures might not be available when you are using certain apps.

Illustration and description



Tap once to single click

Illustration and description



Tap twice quickly to double-click



Tap and hold to right-click

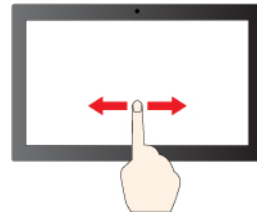

Slide to scroll through items

Illustration and description

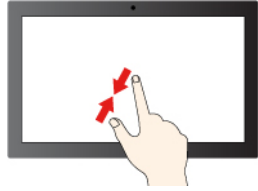

Zoom out

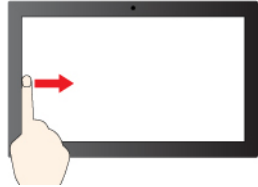

Swipe from the left: view all open windows (Windows 10)

Swipe from the left: open widget panel (Windows 11)

Illustration and description

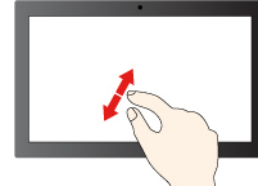

Zoom in

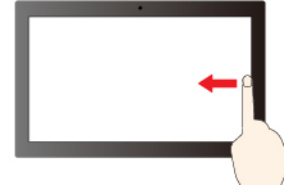

Swipe from the right: open action center (Windows 10)

Swipe from the right: open notification center (Windows 11)

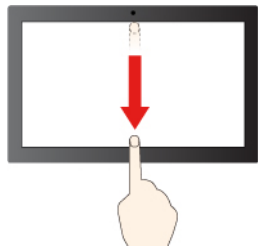

Swipe downwards shortly: show title bar

Swipe downwards: close the current app

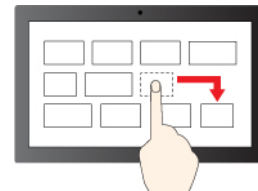

Drag

Maintenance tips:

- Turn off the computer before cleaning the touch screen.
- Use a dry, soft, and lint-free cloth or a piece of absorbent cotton to remove fingerprints or dust from the touch screen. Do not apply solvents to the cloth.
- The touch screen is a glass panel covered with a plastic film. Do not apply pressure or place any metallic object on the screen, which might damage the touch panel or cause it to malfunction.
- Do not use fingernails, gloved fingers, or inanimate objects for input on the screen.
- Regularly calibrate the accuracy of the finger input to avoid a discrepancy.

Connect to an external display

Connect your computer to a projector or a monitor to give presentations or expand your workspace.

Connect to a wired display

If your computer cannot detect the external display, right-click a blank area on the desktop and select **Display settings**. Then follow the on-screen instructions to detect the external display.

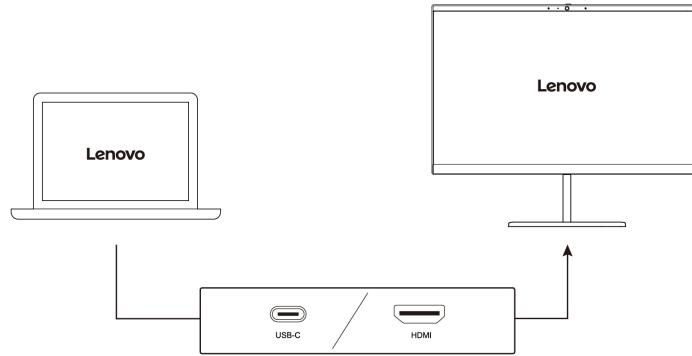

Supported resolution

The following table lists the supported maximum resolution of the external display.



Connect the external display to	Supported resolution
USB-C (3.2 Gen 2) power connector	Up to 4K / 60 Hz
HDMI™ connector	Up to 4K / 30 Hz

Connect to a wireless display

To use a wireless display, ensure that both your computer and the external display support the Miracast® feature.

Press Windows logo key+K key and then select a wireless display to connect with.

Set the display mode

Press  or  +  and then select a display mode of your preference.

Change display settings

1. Right-click a blank area on the desktop and select **Display settings**.
2. Select the display that you want to configure and change display settings of your preference.

You can change the settings for both the computer display and the external display. For example, you can define which one is the main display and which one is the secondary display. You also can change the resolution and orientation.

Get to know YOGA modes (for Lenovo 300w Yoga Gen 4 and Lenovo 500w Yoga Gen 4 only)

Rotate the display to switch among different YOGA modes according to your preference. The keyboard and the pointing devices are automatically disabled in the stand mode, tent mode, and tablet mode. Use the touch screen to control your computer instead.

Attention: Do not rotate the computer display with too much force, or apply too much force to the upper-right or upper-left corner of the computer display. Otherwise the display or hinges might get damaged.

Notebook mode



Stand mode



Tent mode





Tablet mode

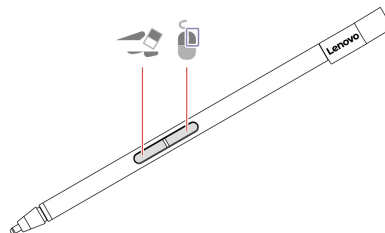

Use Lenovo Integrated Pen (for selected models of Lenovo 300w Yoga Gen 4 and Lenovo 500w Yoga Gen 4)

The garaged rechargeable electronic Lenovo Integrated Pen enables a more precise and easier way of writing and sketching.



Item	Description	Item	Description
	Eraser button		Right-click button

Notes:

- Lenovo Integrated Pen is not waterproof. Keep the pen away from water and excessive moisture.
- To purchase Lenovo Integrated Pen, go to <https://www.lenovo.com/accessories>.
- Selected models support pencil with a conductive tip. The tip diameter should be more than 2 mm. Also, the diameter of the contact area between the tip and screen should be more than 1.5 mm.

Charge Lenovo Integrated Pen

1. Ensure that your computer is on or in sleep mode.
2. Insert the pen back into the pen slot. One 15-second charge enables you to use the pen for up to half an hour. The pen is fully charged in about five minutes.

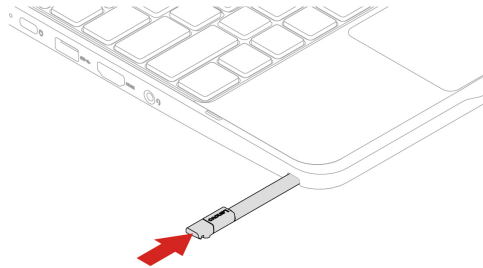

Chapter 3. Explore your computer

Lock the computer

Lock your computer to a desk, table, or other fixtures through a compatible security cable lock.

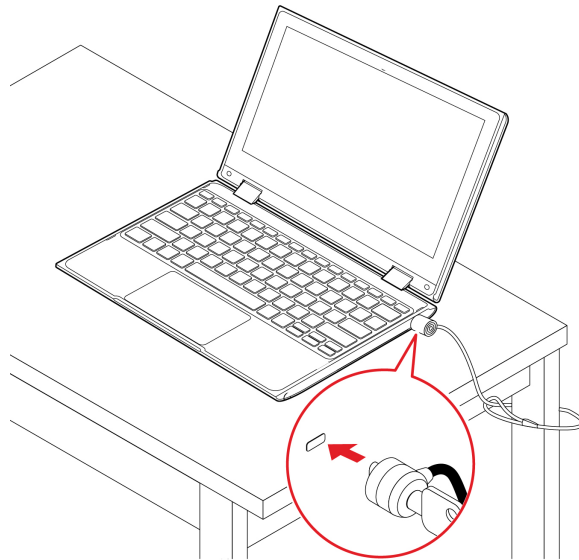

Note: The slot supports cable locks that conform to the Kensington NanoSaver® lock standards using Cleat™ locking technology. You are responsible for evaluating, selecting, and implementing the locking device and security feature. Lenovo is not responsible for the locking device and security feature. You can purchase the cable locks at <https://smartfind.lenovo.com>.

Lenovo Commercial Vantage

The Lenovo Commercial Vantage app (hereafter referred to as Vantage app) is a customized one-stop solution to help you maintain your computer with automated updates and fixes, configure hardware settings, and get personalized support.

To access the Vantage app, type Lenovo Commercial Vantage in the Windows search box.

Notes:

- The available features vary depending on the computer model.
- The Vantage app makes periodic updates of the features to keep improving your experience with your computer. The description of features might be different from that on your actual user interface. Ensure that you use the latest version of Vantage app, and apply Windows Update to get the latest updates.

The Vantage app enables you to:

- Know the device status easily and customize device settings.
- Download and install UEFI BIOS, firmware, and driver updates to keep your computer up-to-date.
- Monitor your computer health, and secure your computer against outside threats.
- Scan your computer hardware and diagnose hardware problems.

- Look up warranty status (online).
- Access *User Guide* and helpful articles.

Manage power

Use the information in this section to achieve the best balance between performance and power efficiency.

Check the battery status

Go to **Settings** → **System** to check the battery status. For more details about your battery, refer to the Vantage app.

Charge the computer

Power source of the ac power adapter:

- Power: 45 W or 65 W
- Sine-wave input at 50 Hz to 60 Hz
- Input rating of the ac power adapter: 100 V to 240 V ac, 50 Hz to 60 Hz
- Output rating of the ac power adapter: 20 V dc, 2.25 A or 3.25 A

When the battery power is low, charge your battery by connecting your computer to ac power with the supplied power adapter. The 65 W ac power adapter supports the rapid charge function, the battery is 80% charged in about one hour when the computer is turned off. The actual charging time depends on the battery size, the physical environment, and whether you are using the computer.

Battery charging is also affected by its temperature. The recommended temperature range for charging the battery is between 10°C (50°F) and 35°C (95°F).

Note: Some models might not ship with ac adapters or power cords. Use only the certified adapters and power cords provided by Lenovo that comply with the requirements of relevant national standards to charge the product. It is recommended to use the Lenovo qualified adapters. You can refer to <https://www.lenovo.com/us/en/compliance/eu-doc>.

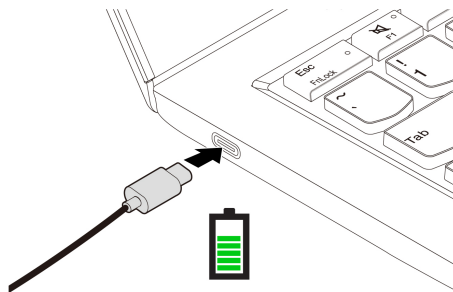

Notes: To maximize the life of the battery:

- Use the battery until the charge is depleted and recharge the battery completely before using it. Once the battery is fully charged, it must discharge to 94% or lower before it will be allowed to recharge again.
- The battery might optimize its full charge capacity based on your usage. After prolonged periods of limited use, full battery capacity might not be available until you discharge to as low as 20% and recharge completely. For more information, refer to the power section of the Vantage app.

Change the power settings

For ENERGY STAR® compliant computers, the following power plan takes effect by default when your computer is on ac power and has been idle for a specified duration:

- For Windows 11:
 - Turn off the display: After 5 minutes
 - Put the computer to sleep: After 15 minutes
- For Windows 10:
 - Turn off the display: After 10 minutes
 - Put the computer to sleep: After 30 minutes

To reset the power plan:

1. Go to **Control Panel** and view by Large icons or Small icons.
2. Click **Power Options**.
3. Choose or customize a power plan of your preference.

To reset the power button function:

1. Go to **Control Panel** and view by Large icons or Small icons.
2. Click **Power Options**, and then click **Choose what the power buttons do** on the left pane.
3. Change the settings as you prefer.

Transfer data

Quickly share your files using the built-in Bluetooth technology among devices with the same features.

Set up a Bluetooth connection

You can connect all types of Bluetooth-enabled devices to your computer, such as a keyboard, a mouse, a smartphone, or speakers. To ensure successful connection, place the devices at most 10 meters (33 feet) from the computer.

1. Type Bluetooth in the Windows search box and then press Enter.
2. Turn on Bluetooth, if it is off.
3. Select a Bluetooth device, and then follow the on-screen instructions.

Chapter 4. Configure advanced settings

UEFI BIOS setup utility

UEFI BIOS setup utility is the first program that the computer runs. When the computer turns on, UEFI BIOS setup utility performs a self test to make sure that various devices in the computer are functioning.

Enter the UEFI BIOS setup utility

Restart the computer. When the logo screen is displayed, press F2 to enter the UEFI BIOS setup utility.

Change the startup sequence

You might need to change the startup sequence to allow the computer to start from another device or a network location.

1. Enter the setup utility.
2. Navigate to the **Boot** menu.
3. Follow the on-screen instructions to change the order of devices under **Boot Priority Order**.

Note: You can also change the startup sequence temporarily without opening the setup utility. To do so, start the computer. When the logo screen is displayed, press F12.

Change the hotkey mode

1. Open the setup utility.
2. Select **Configuration** → **Hotkey Mode** and press Enter.
3. Change the setting to **Disabled** or **Enabled**.
4. Select **Exit** → **Exit Saving Changes**.

Enable or disable the Always On USB function

For computer models with the Always On USB connector, the always-on function can be enabled or disabled in the setup utility.

1. Open the setup utility.
2. Select **Configuration** → **Always On USB** and press Enter.
3. Change the setting to **Disabled** or **Enabled**.
4. Select **Exit** → **Exit Saving Changes**.

Use passwords

This section introduces the types of passwords that you can set in the setup utility.

Password types

You can set various types of passwords in the UEFI BIOS setup utility.

Notes:

- All passwords set in the setup utility consist of alphanumeric characters only.
- If you start the setup utility using the user password, you can only change a few settings.

Password type	Pre-requisite	Usage
Administrator password	No	Use the administrator password to enter the setup utility.
User password	The administrator password must be set.	Use the user password to enter the setup utility.
Master hard disk password	No	Use master hard disk password to enter the setup utility or operating system.
User hard disk password	The master hard disk password must be set.	Use the user hard disk password to enter the setup utility or operating system.

Set an administrator password

You can set the administrator password to prevent unauthorized access to the setup utility.

Attention: If you forget the administrator password, a Lenovo authorized service personnel cannot reset your password. You must take your computer to a Lenovo authorized service personnel to have the system board replaced. Proof of purchase is required and a fee will be charged for parts and service.

1. Enter the setup utility.
2. Select **Security** → **Set Administrator Password** and press Enter.
3. Enter a password string that contains only letters and numbers and then press Enter.
4. Enter the password again and press Enter.
5. Select **Exit** → **Exit Saving Changes**.

Next time you turn on the computer, you should enter the administrator password to enter the setup utility.

Change or remove the administrator password

Only the administrator can change or remove the administrator password.

1. Enter the setup utility.
2. Select **Security** → **Set Administrator Password** and press Enter.
3. Enter the current password.
4. In the **Enter New Password** field, enter the new password.
5. In the **Confirm New Password** field, enter the new password again.

Note: If you want to remove the password, leave both fields blank, and press Enter twice.

6. Select **Exit** → **Exit Saving Changes**.

If you remove the administrator password, the user password is also removed.

Set a user password

You must set the administrator password before you can set the user password. The system administrator might need to set a user password so that other users can access the computer.

1. Enter the setup utility.
2. Select **Security** → **Set User Password** and press Enter.
3. Enter a password string that contains only letters and numbers and then press Enter.

Note: The user password should be different from the administrator password.

4. Enter the password again and press Enter.
5. Select **Exit → Exit Saving Changes**.

Change or remove the user password

1. Enter the setup utility.
2. Select **Security → Set User Password** and press Enter.
3. Enter the current password.
4. In the **Enter New Password** field, enter the new password.
5. In the **Confirm New Password** field, enter the new password again.

Note: If you want to remove the password, leave both fields blank, and press Enter twice.

6. Select **Exit → Exit Saving Changes**.

Enable the power on password

If the administrator password has been set, you can enable the power on password to enforce stronger security.

1. Enter the setup utility.
2. Select **Security → Power on Password** and press Enter.

Note: The administrator password must be set in advance.

3. Change the setting to **Enabled**.
4. Select **Exit → Exit Saving Changes**.

If the power on password is enabled, you must enter the administrator password or user password every time you enter the setup utility.

Set a hard disk password

You can set a hard disk password in the setup utility to prevent unauthorized access to your data.

Attention: Be extremely careful when setting a hard disk password. If you forget the master hard disk password, a Lenovo authorized service personnel cannot reset your password or recover data from the hard disk. You must take your computer to a Lenovo authorized service personnel to have the hard disk drive replaced. Proof of purchase is required and a fee will be charged for parts and service.

Notes:

- If you start the setup utility using the user password, you cannot set the hard disk password.
- The master hard disk password and user hard disk password must be set at the same time.
 1. Enter the setup utility.
 2. Select **Security → Set Hard Disk Password** and press Enter.
 3. Follow the on-screen instructions to set both the master hard disk password and user hard disk password.
 4. Select **Exit → Exit Saving Changes**.

If the hard disk password is set, you must enter the password to enter the setup utility or the operating system.

Change or remove the hard disk password

1. Enter the setup utility.

2. Select **Security**.
3. To change or remove the hard disk password, do one of the following:
 - To change or remove the master hard disk password, select **Change Master Password** and press Enter.

Notes:

- If you remove the master hard disk password, the user hard disk password is also removed.
 - The user hard disk password cannot be removed separately.
 - To change the user hard disk password, select **Change User Password** and press Enter.
4. Select **Exit** → **Exit Saving Changes**.

Install a Windows operating system and drivers

This section provides instructions on installing a Windows operating system and device drivers.

Install a Windows operating system

Microsoft constantly makes updates to the Windows operating system. Before installing a particular Windows version, check the compatibility list for the Windows version. For details, go to <https://support.lenovo.com/us/en/solutions/windows-support>.

Attention:

- It is recommended that you update your operating system through official channels. Any unofficial update might cause security risks.
- The process of installing a new operating system deletes all the data on your internal storage drive, including the data stored in a hidden folder.

1. If you are using the Windows BitLocker® Drive Encryption feature and your computer has a Trusted Platform Module, ensure that you have disabled the feature.
2. Ensure that the security chip is set to **Enabled**.
 - a. Restart the computer. When the logo screen is displayed, press F2 to enter the setup utility.
 - b. Select **Security** and ensure security chip is set to **Enabled**.
 - c. Press F10 to save the settings and exit.
3. Connect the drive that contains the operating system installation program to the computer.
4. Restart the computer. When the logo screen is displayed, press F2 to enter the setup utility.
5. Select **Boot** → **Edit Boot Order** to display the **Boot Priority Order** submenu.
6. Select the drive that contains the operating system installation program, for example, **USB HDD**. Press F6 to move the drive to the first order. Then, press F10 to save the setting and exit.

Attention: After you change the startup sequence, ensure that you select the correct device during a copy, a save, or a format operation. If you select the wrong device, the data on that device might be erased or overwritten.

7. The system restarts. Follow the on-screen instructions to install the device drivers and necessary programs.
8. After installing the device drivers, apply Windows Update to get the latest updates, for example the security patches.

Install device drivers

You should download the latest driver for a component when you notice poor performance from that component or when you added a component. This action might eliminate the driver as the potential cause of a problem. Download and install the latest driver by one of the following methods:

- Open the Vantage app to check the available update packages. Select the update packages you want, and then follow the on-screen instructions to download and install the packages.
- Go to <https://pcsupport.lenovo.com> and select the entry for your computer. Then, follow the on-screen instructions to download and install necessary drivers and software.

Use firewalls and antivirus programs

Your computer might be preinstalled with a firewall program. The firewall protects against computer Internet security threats, unauthorized access, intrusions, and Internet attacks. It also protects your privacy.

A full version of the antivirus program is provided with a free 30-day subscription. After 30 days, you must renew the license to continue receiving the antivirus program updates.

For more information, see the help system of the program.

Chapter 5. CRU replacement

Customer Replaceable Units (CRUs) are parts that can be replaced by the customer. The computers contain the following types of CRUs:

- **Self-service CRUs:** Refer to parts that can be replaced easily by customer themselves or by trained service technicians at an additional cost.
- **Optional-service CRUs:** Refer to parts that can be replaced by customers with a greater skill level. Trained service technicians can also provide service to replace the parts under the type of warranty designated for the customer's machine.

If you intend on installing a CRU, Lenovo will ship the CRU to you. CRU information and replacement instructions are shipped with your product and are available from Lenovo at any time upon request. You might be required to return the defective part that is replaced by the CRU. When return is required: (1) return instructions, a prepaid shipping label, and a container will be included with the replacement CRU; and (2) you might be charged for the replacement CRU if Lenovo does not receive the defective CRU within thirty (30) days of your receipt of the replacement CRU. For full details, see the Lenovo Limited Warranty documentation at https://www.lenovo.com/warranty/llw_02.

CRU list

Refer to the following CRU list for your computer.

Self-service CRUs

- ac power adapter
- Lenovo Integrated Pen (for selected models of Lenovo 300w Yoga Gen 4 and Lenovo 500w Yoga Gen 4 only)
- Pen dummy (for selected models of Lenovo 300w Yoga Gen 4 and Lenovo 500w Yoga Gen 4 only)
- Power cord

Optional-service CRUs

- Base cover assembly
- Keyboard
- M.2 solid state drive*
- Wireless WAN module (for selected models of Lenovo 300w Yoga Gen 4 only)

* for selected models

Note: Replacement of any parts not listed above, including the built-in rechargeable battery, should be done by a qualified repair technician or by ensuring that you carefully follow all instructions provided by Lenovo. You can also find Lenovo-authorized repair facilities by going to <https://support.lenovo.com/partnerlocator> for more information.

Disable Fast Startup and the built-in battery

Before replacing any CRU, ensure that you disable Fast Startup first and then disable the built-in battery.

To disable Fast Startup:

1. Go to **Control Panel** and view by Large icons or Small icons.

2. Click **Power Options**, and then click **Choose what the power buttons do** on the left pane.
3. Click **Change settings that are currently unavailable** at the top.
4. If prompted by User Account Control (UAC), click **Yes**.
5. Clear the **Turn on fast startup** check box, and then click **Save changes**.

To disable the built-in battery:

1. Enter the setup utility.
2. Select **Configuration** → **Disable Built-in Battery** and press Enter.
3. Select **Yes** in the Setup Confirmation window. The built-in battery is disabled and the computer turns off automatically. Wait three to five minutes to let the computer cool.

Replace a CRU

Follow the replacement procedure to replace a CRU.

Pen dummy (for selected models of Lenovo 300w Yoga Gen 4 and Lenovo 500w Yoga Gen 4)

Prerequisite

Before you start, read [Generic Safety and Compliance Notices](#) and print the following instructions.

For computer models come with a pen dummy, you can purchase a Lenovo Integrated Pen to use. To purchase the pen, go to <https://www.lenovo.com/accessories>. To use the pen, see “Use Lenovo Integrated Pen (for selected models of Lenovo 300w Yoga Gen 4 and Lenovo 500w Yoga Gen 4)” on page 15.

For access, do the following:

1. Ensure that your computer is off or in sleep mode. Disconnect the computer from ac power and all connected cables.
2. Close the computer display and turn the computer over.

Removal procedure

Prepare a tool as shown to remove the pen dummy.

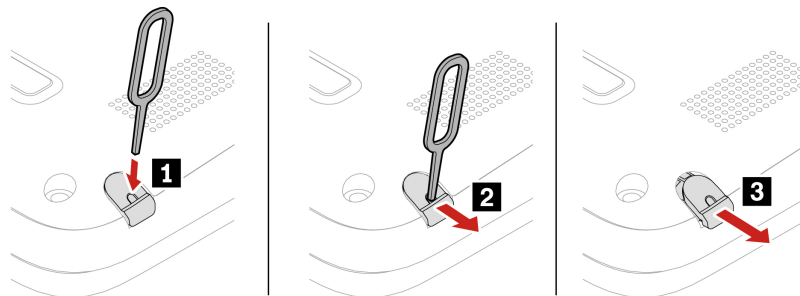

Keyboard

Prerequisite

Before you start, read [Generic Safety and Compliance Notices](#) and print the following instructions.

For access, do the following:

1. Disable the built-in battery. See “Disable Fast Startup and the built-in battery” on page 27.
2. Turn off the computer and disconnect the computer from ac power and all connected cables.

Removal procedure

1. Loosen the screw that secures the keyboard.

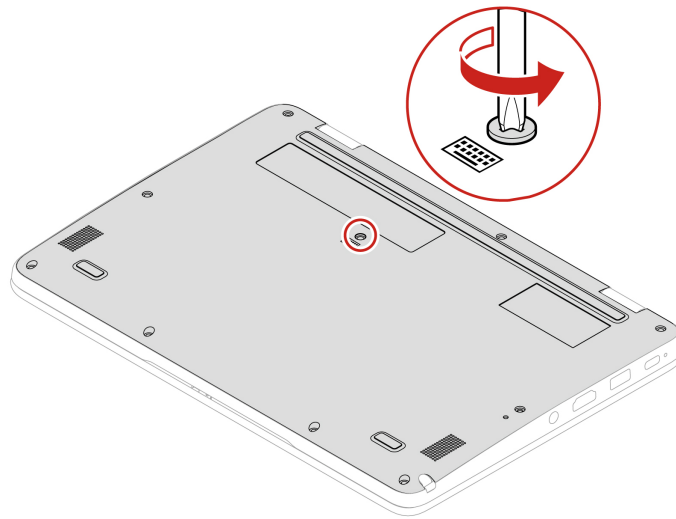

2. Push the keyboard in the direction as shown by arrows to release the latches from the keyboard bezel.

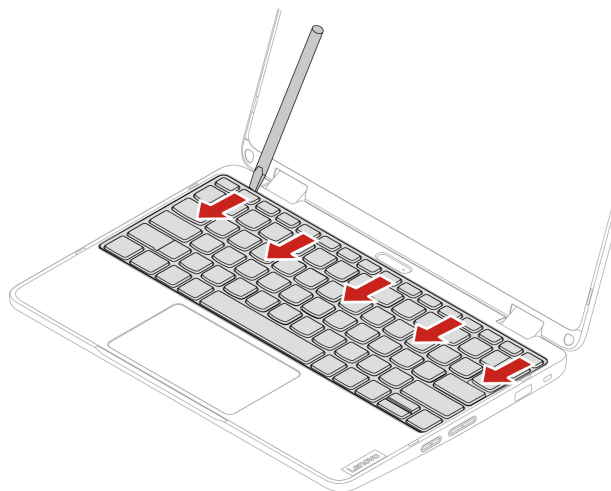

3. Pivot the keyboard slightly upward.



4. Detach the connector and remove the keyboard.

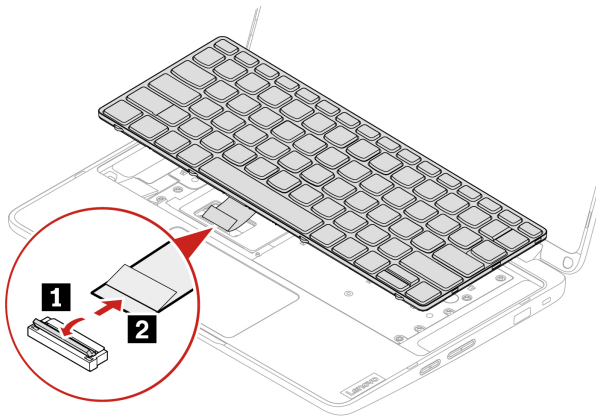

Installation procedure

1. Attach the connector.

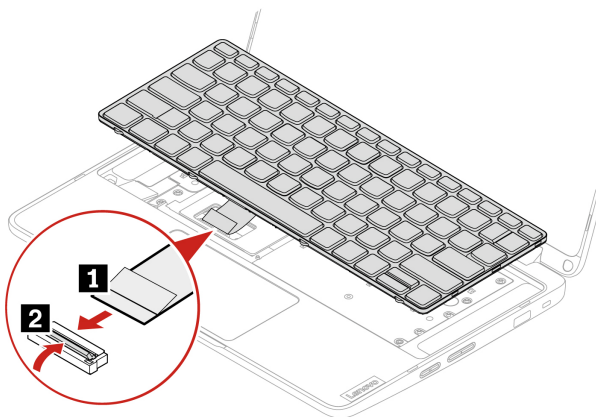

2. Insert the keyboard into the keyboard bezel as shown. Ensure that the bottom edge of the keyboard (the edge that is close to the trackpad) is under the keyboard bezel.

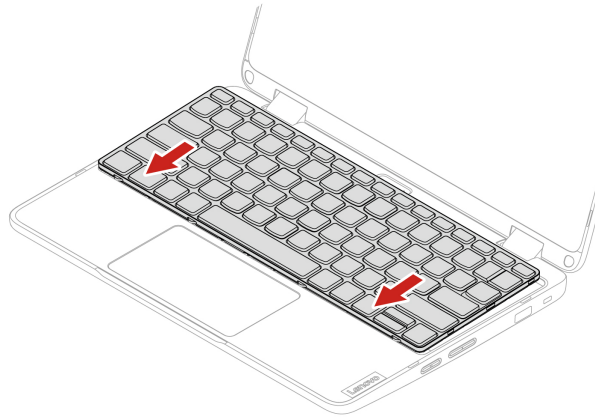

3. Slightly push the keyboard as shown and ensure that it is seated correctly.

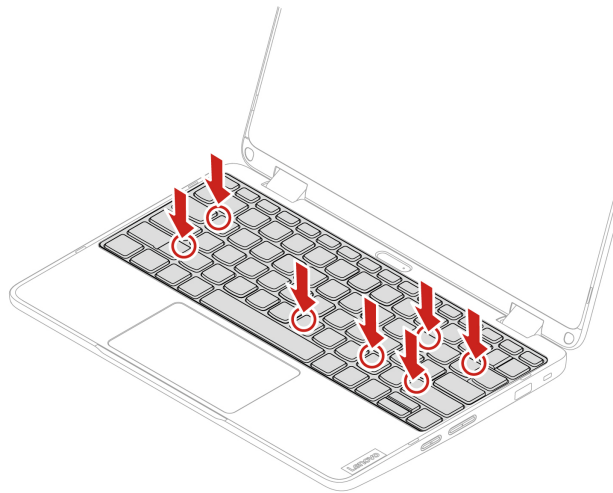

4. Tighten the screw to secure the keyboard.

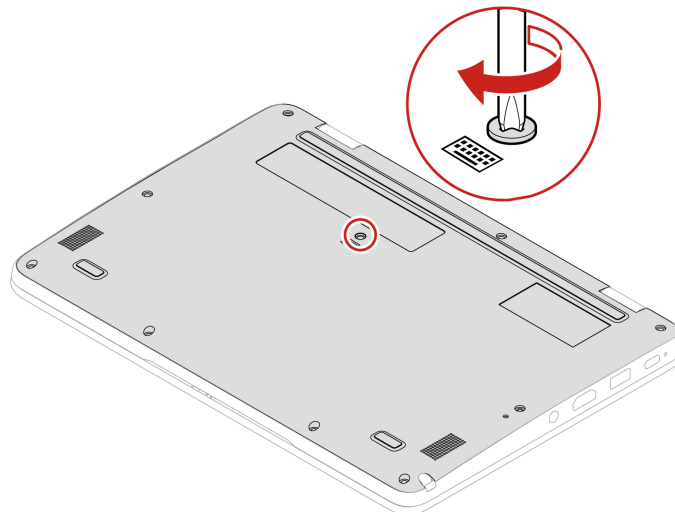

5. Connect the ac power adapter and all disconnected cables to the computer.

Base cover assembly

Prerequisite

Before you start, read [Generic Safety and Compliance Notices](#) and print the following instructions.

Note: Do not remove the base cover assembly when your computer is connected to ac power. Otherwise, there might be a risk of short circuits.

For access, do the following:

1. Disable the built-in battery. See “Disable Fast Startup and the built-in battery” on page 27.
2. Turn off the computer and disconnect the computer from ac power and all connected cables.
3. Close the computer display and turn over the computer.

Removal procedure

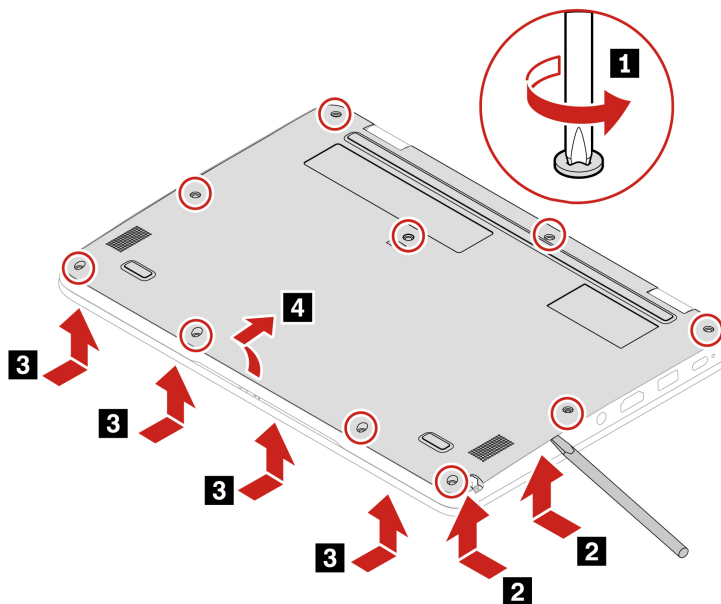

Installation procedure

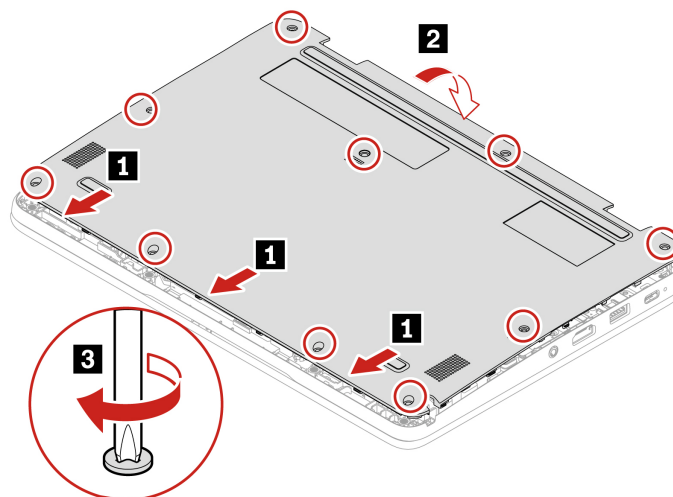

Troubleshooting

If the computer does not start up after you reinstall the base cover assembly, disconnect the ac power adapter and then reconnect it to the computer.

M.2 solid-state drive (for selected models)

Prerequisite

Before you start, read [Generic Safety and Compliance Notices](#) and print the following instructions.

Attention: If you replace a M.2 solid-state drive, you might need to install a new operating system. For details on how to install a new operating system, see “Install a Windows operating system and drivers” on page 24.

The M.2 solid-state drive is sensitive. Inappropriate handling might cause damage and permanent loss of data.

When handling the M.2 solid-state drive, observe the following guidelines:

- Replace the M.2 solid-state drive only for repair. The M.2 solid-state drive is not designed for frequent changes or replacement.
- Before replacing the M.2 solid-state drive, make a backup copy of all the data that you want to keep.
- Do not apply pressure to the M.2 solid-state drive.
- Do not touch the contact edge or circuit board of the M.2 solid-state drive. Otherwise, the M.2 solid-state drive might get damaged.
- Do not subject the M.2 solid-state drive to physical shocks or vibration. Put the M.2 solid-state drive on a soft material, such as cloth, to absorb physical shocks.

For access, do the following:

1. Disable the built-in battery. See “Disable Fast Startup and the built-in battery” on page 27.
2. Turn off the computer and disconnect the computer from ac power and all connected cables.
3. Close the computer display and turn the computer over.
4. Remove the base cover assembly. See “Base cover assembly” on page 32.

For wireless LAN model:

Removal procedure

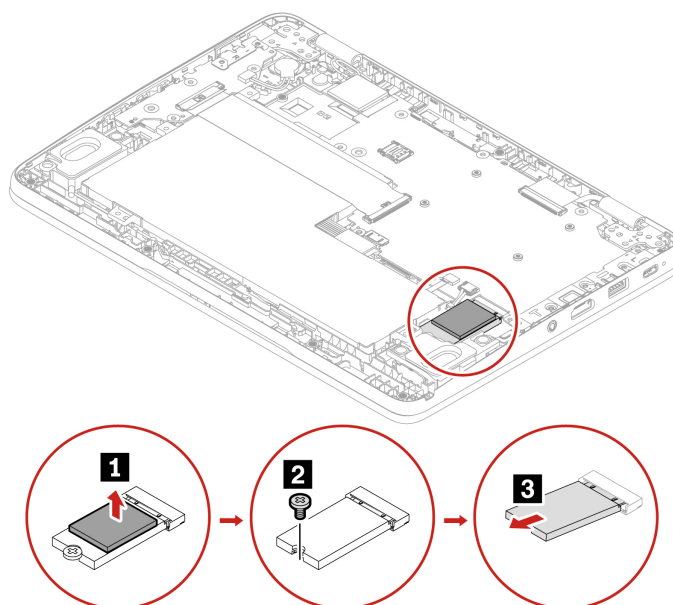

Installation procedure

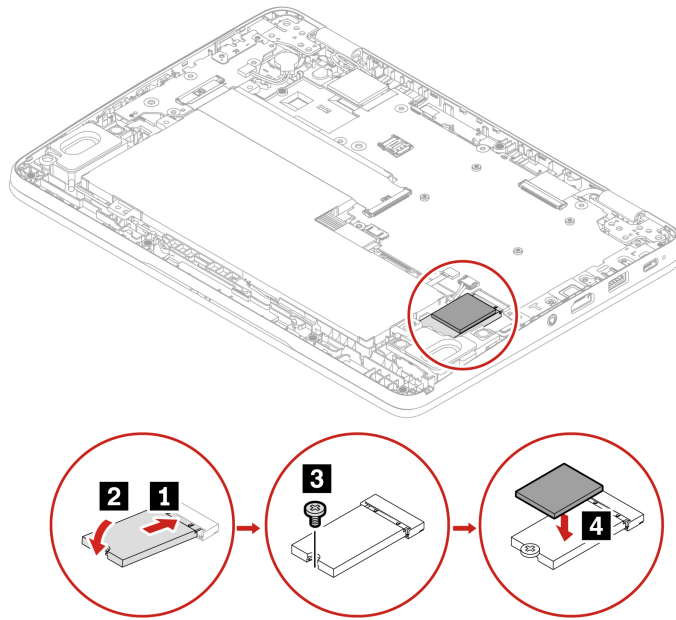

For wireless WAN model:

Removal procedure

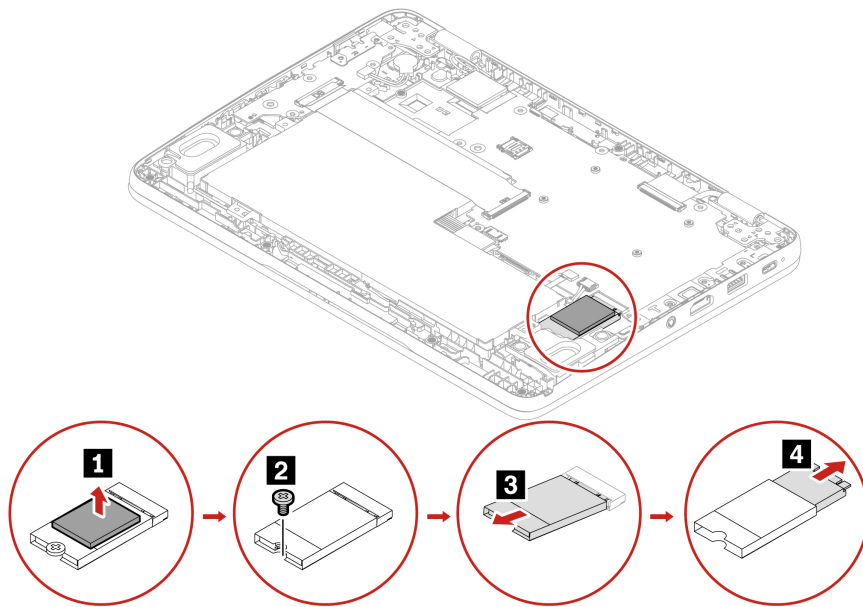

Installation procedure

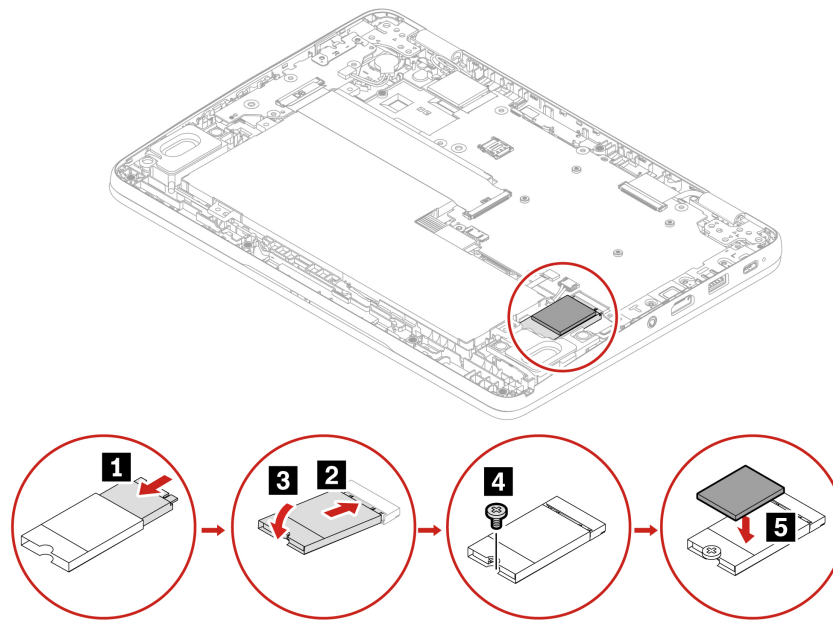

Wireless WAN module (for selected models of 300w Yoga Gen 4 only)

The following information is only for the computer with user-installable modules. Ensure that you use only a Lenovo-authorized wireless module specifically tested for this computer model. Otherwise, the computer will generate an error-code beep sequence when you turn on the computer.

Notes:

- Wireless WAN ready model identifies that product has preinstalled wireless WAN antennas and allows a user-installable wireless WAN module.
- Only wireless WAN model or wireless WAN ready model is allowed to install the optional Lenovo wireless WAN module.

Prerequisite

Before you start, read [Generic Safety and Compliance Notices](#) and print the following instructions.

Attention: Do not touch the contact edge of the wireless WAN module. Otherwise, the wireless WAN module might get damaged.

For access, do the following:

1. Disable the built-in battery. See “Disable Fast Startup and the built-in battery” on page 27.
2. Turn off the computer and disconnect the computer from ac power and all connected cables.
3. Close the computer display and turn the computer over.
4. Remove the base cover assembly. See “Base cover assembly” on page 32.

Removal procedure

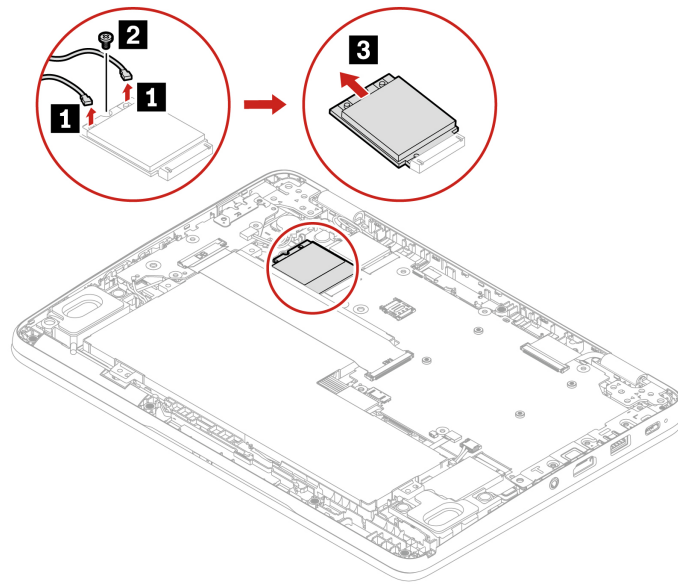

When installing: Ensure you plug the blue cable into connector **AUX** and orange cable into connector **Main** marked on the wireless WAN module.

Chapter 6. Help and support

Frequently asked questions

Question	Solution
How do I open the Control Panel?	Type Control Panel in the Windows search box and then press Enter.
How should I turn off my computer?	Open the Start menu and select Power → Shut down . Notes: If you want to save battery power, do the following: <ol style="list-style-type: none">1. Press and hold Shift.2. Open the Start menu and select Power → Shut down.3. Release Shift.
How do I partition my storage drive?	Refer to https://support.lenovo.com/solutions/ht503851 .
What should I do if my computer stops responding?	Press and hold the power button until the computer turns off. Then restart the computer. <ol style="list-style-type: none">1. Carefully unplug the ac power adapter and turn off the computer immediately. The more quickly you stop the current from passing through the computer the more likely you will reduce damage from short circuits.
What should I do if I spill liquid on the computer?	Attention: Although you might lose some data or work by turning off the computer immediately, leaving the computer on might make your computer unusable. <ol style="list-style-type: none">2. Wait until you are certain that all the liquid is dry before turning on your computer. CAUTION: Do not try to drain out the liquid by turning over the computer. If your computer has keyboard drainage holes on the bottom, the liquid will be drained out through the holes.
Where can I get the latest device drivers and UEFI BIOS?	<ul style="list-style-type: none">• The Vantage app• Lenovo Support Web site at https://support.lenovo.com
How do I disinfect my computer?	<ol style="list-style-type: none">1. Squeeze out excess liquid from wipe or disinfecting cloth before using. Recommended wipes are hydrogen peroxide wipes and alcohol based wipes. Do not use wipes containing sodium hypochlorite (bleach).2. Gently wipe the computer thoroughly, being careful to ensure no liquid drips into the computer. Do not wipe on connector pins.3. After disinfecting, follow the cleaning procedure from the wipe supplier to minimize chemical buildup of disinfectant residue.4. Always allow the computer to completely dry prior to any use.

Self-help resources

Use the following self-help resources to learn more about the computer and troubleshoot problems.

Resources	How to access?
Troubleshooting and FAQ	<ul style="list-style-type: none">• https://www.lenovo.com/tips• https://forums.lenovo.com
Accessibility information	https://www.lenovo.com/accessibility
Reset or restore Windows	<ul style="list-style-type: none">• Use Lenovo recovery options.<ol style="list-style-type: none">1. Go to https://support.lenovo.com/HowToCreateLenovoRecovery.2. Follow the on-screen instructions.• Use Windows recovery options.<ol style="list-style-type: none">1. Go to https://pcsupport.lenovo.com.2. Detect your computer or manually select your computer model.3. Navigate to the troubleshooting menu to diagnose the operating system for recovery instructions.
Use the Vantage app to: <ul style="list-style-type: none">• Configure device settings.• Download and install UEFI BIOS, drivers, and firmware updates.• Secure your computer from outside threats.• Diagnose hardware problems.• Check the computer warranty status.• Access <i>User Guide</i> and helpful articles.	Type Vantage in the Windows search box and then press Enter.
Product documentation: <ul style="list-style-type: none">• <i>Safety and Warranty Guide</i>• <i>Generic Safety and Compliance Notices</i>• <i>Setup Guide</i>• <i>This User Guide</i>• <i>Regulatory Notice</i>	Go to https://pcsupport.lenovo.com . Then, follow the on-screen instructions to filter out the documentation you want.

Resources	How to access?
<p>Lenovo Support Web site with the latest support information of the following:</p> <ul style="list-style-type: none"> • Drivers and software • Diagnostic solutions • Product and service warranty • Product and parts details • Knowledge base and frequently asked questions 	<p>https://pcsupport.lenovo.com</p>
<p>Windows help information</p>	<ul style="list-style-type: none"> • Open the Start menu and click Get Help or Tips. • Use Windows Search or the Cortana® personal assistant. • Microsoft support Web site: https://support.microsoft.com

Windows label

Your computer might have a Windows Genuine Microsoft label affixed to its cover depending on the following factors:

- Your geographic location
- Edition of Windows that is preinstalled

Go to <https://www.microsoft.com/en-us/howtotell/Hardware.aspx> for illustrations of the various types of Genuine Microsoft labels.

- In the People's Republic of China, the Genuine Microsoft label is required on all computer models preinstalled with any edition of the Windows operating system.
- In other countries and regions, the Genuine Microsoft label is required only on computer models licensed for Windows Pro editions.

The absence of a Genuine Microsoft label does not indicate that the preinstalled Windows version is not genuine. For details on how to tell whether your preinstalled Windows product is genuine, refer to the information provided by Microsoft at <https://www.microsoft.com/en-us/howtotell/default.aspx>.

There are no external, visual indicators of the Product ID or Windows version for which the computer is licensed. Instead, the Product ID is recorded in the computer firmware. Whenever a Windows product is installed, the installation program checks the computer firmware for a valid, matching Product ID to complete the activation.

In some cases, an earlier Windows version might be preinstalled under the terms of the Windows Pro edition license downgrade rights.

Call Lenovo

If you have tried to correct the problem yourself and still need help, you can call Lenovo Customer Support Center.

Before you contact Lenovo

Prepare the following before you contact Lenovo:

1. Record the problem symptoms and details:

- What is the problem? Is it continuous or intermittent?
- Any error message or error code?
- What operating system are you using? Which version?
- Which software applications were running at the time of the problem?
- Can the problem be reproduced? If so, how?

2. Record the system information:

- Product name
- Machine type and serial number

The following illustration shows where to find the machine type and serial number of your computer.

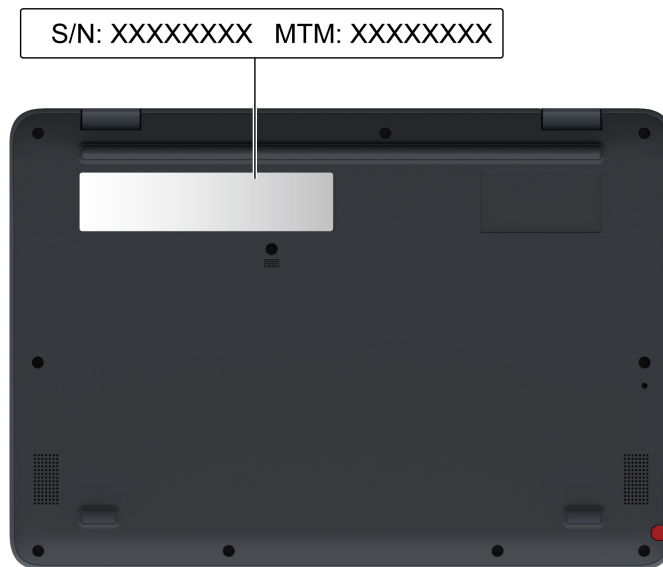

Lenovo Customer Support Center

During the warranty period, you can call Lenovo Customer Support Center for help.

Telephone numbers

For a list of the Lenovo Support phone numbers for your country or region, go to <https://pcsupport.lenovo.com/supportphonenumber> for the latest phone numbers.

Note: Phone numbers are subject to change without notice. If the number for your country or region is not provided, contact your Lenovo reseller or Lenovo marketing representative.

Services available during the warranty period

- Problem determination - Trained personnel are available to assist you with determining if you have a hardware problem and deciding what action is necessary to fix the problem.
- Lenovo hardware repair - If the problem is determined to be caused by Lenovo hardware under warranty, trained service personnel are available to provide the applicable level of service.
- Engineering change management - Occasionally, there might be changes that are required after a product has been sold. Lenovo or your reseller, if authorized by Lenovo, will make selected Engineering Changes (ECs) that apply to your hardware available.

Services not covered

- Replacement or use of parts not manufactured for or by Lenovo or nonwarranted parts
- Identification of software problem sources
- Configuration of UEFI BIOS as part of an installation or upgrade
- Changes, modifications, or upgrades to device drivers
- Installation and maintenance of network operating systems (NOS)
- Installation and maintenance of programs

For the terms and conditions of the Lenovo Limited Warranty that apply to your Lenovo hardware product, go to:

- https://www.lenovo.com/warranty/llw_02
- <https://pcsupport.lenovo.com/warrantylookup>

Appendix A. Compliance information

For compliance information, refer to *Regulatory Notice* at <https://pcsupport.lenovo.com> and *Generic Safety and Compliance Notices* at https://pcsupport.lenovo.com/docs/generic_notices.

Locate the wireless antennas

Your computer has a wireless antenna system. You can enable wireless communication wherever you are. The following illustrations show the antenna locations on your computer.

Lenovo 100w Gen 4 / Lenovo 500w Yoga Gen 4 / wireless LAN model of Lenovo 300w Yoga Gen 4:



- 1 Wireless-LAN antenna (auxiliary)
- 2 Wireless-LAN antenna (main)

Wireless WAN model of Lenovo 300w Yoga Gen 4:



- 1 Wireless-WAN antenna (auxiliary)
- 2 Wireless-LAN antenna (main)
- 3 Wireless-WAN antenna (main)
- 4 Wireless-LAN antenna (auxiliary)

Certification-related information

Product name	Machine type(s)
Lenovo 100w Gen 4	82VK, 82VL
Lenovo 300w Yoga Gen 4	82VM, 82VN
Lenovo 500w Yoga Gen 4	82VQ, 82VR

Further compliance information related to your product is available at <https://www.lenovo.com/compliance>.

Safety instructions for teachers, parents and adult supervisors

This computer is intended for use as a child development tool primarily by children, 6 years of age or above. There must be supervision by an adult. It is a must to have a thorough explanation to children on safe and proper handling of the computer, battery pack, and ac power adapter.

- For ITE with power supplies not intended to be handled by children: As with all electrical products, precautions should be observed handling and use to prevent electric shock. The ac power adapter should not be handled by children.
- The computer should not be placed on the bare skin (lap) of the child for long periods. The computer should be placed on a flat surface, like desktop, if your child intends to use it for more than a few minutes.
- The computer (including the ac power adapter and the battery pack, as applicable) should not be left in the rain or subjected to exposure to water. If cleaning is necessary do not immerse it in water; wipe clean with damp cloth.
- The computer (including the ac power adapter and the battery pack, as applicable) should not be dropped, crushed (stepped on) or otherwise abused.
- An adult should caution his or her child about the potential trip hazard as posed by the cable between a power source and the computer. An adult should inspect the computer (including the ac power adapter and the battery pack, as applicable) periodically for damage. Similarly, if a child notices damaged/broken parts, this should be reported to the teacher/parents/adult supervisors immediately. Damaged parts may be replaced through service provided by Lenovo.

Chocking Hazard – Small parts. Not suitable for children under age 3.



<p>ELECTRICALLY OPERATED PRODUCT. Not recommended for children under 3 years of age (or other intended age range). As with all electrical products, precautions should be observed during handling and use of electrical products to reduce the risk of electric shock.</p>
--

Operating environment

Maximum altitude (without pressurization)

3048 m (10 000 ft)

Temperature

- Operating: 5°C to 35°C (41°F to 95°F)
- Storage: 5°C to 43°C (41°F to 109°F)

Note: When you charge the battery, its temperature must be no lower than 10°C (50°F).

Relative humidity

- Operating: 8% to 95% at wet-bulb temperature 23°C (73°F)
- Storage: 5% to 95% at wet-bulb temperature 27°C (81°F)

Appendix B. Notices and trademarks

Notices

Lenovo may not offer the products, services, or features discussed in this document in all countries. Consult your local Lenovo representative for information on the products and services currently available in your area. Any reference to a Lenovo product, program, or service is not intended to state or imply that only that Lenovo product, program, or service may be used. Any functionally equivalent product, program, or service that does not infringe any Lenovo intellectual property right may be used instead. However, it is the user's responsibility to evaluate and verify the operation of any other product, program, or service.

Lenovo may have patents or pending patent programs covering subject matter described in this document. The furnishing of this document does not give you any license to these patents. You can send license inquiries, in writing, to:

*Lenovo (United States), Inc.
8001 Development Drive
Morrisville, NC 27560
U.S.A.
Attention: Lenovo Director of Licensing*

LENOVO PROVIDES THIS PUBLICATION "AS IS" WITHOUT WARRANTY OF ANY KIND, EITHER EXPRESS OR IMPLIED, INCLUDING, BUT NOT LIMITED TO, THE IMPLIED WARRANTIES OF NON-INFRINGEMENT, MERCHANTABILITY OR FITNESS FOR A PARTICULAR PURPOSE. Some jurisdictions do not allow disclaimer of express or implied warranties in certain transactions, therefore, this statement may not apply to you.

Changes are made periodically to the information herein; these changes will be incorporated in new editions of the publication. To provide better service, Lenovo reserves the right to improve and/or modify the products and software programs described in the manuals included with your computer, and the content of the manual, at any time without additional notice.

The software interface and function and hardware configuration described in the manuals included with your computer might not match exactly the actual configuration of the computer that you purchase. For the configuration of the product, refer to the related contract (if any) or product packing list, or consult the distributor for the product sales. Lenovo may use or distribute any of the information you supply in any way it believes appropriate without incurring any obligation to you.

The products described in this document are not intended for use in implantation or other life support applications where malfunction may result in injury or death to persons. The information contained in this document does not affect or change Lenovo product specifications or warranties. Nothing in this document shall operate as an express or implied license or indemnity under the intellectual property rights of Lenovo or third parties. All information contained in this document was obtained in specific environments and is presented as an illustration. The result obtained in other operating environments may vary.

Lenovo may use or distribute any of the information you supply in any way it believes appropriate without incurring any obligation to you.

Any references in this publication to non-Lenovo Web sites are provided for convenience only and do not in any manner serve as an endorsement of those Web sites. The materials at those Web sites are not part of the materials for this Lenovo product, and use of those Web sites is at your own risk.

Any performance data contained herein was determined in a controlled environment. Therefore, the result obtained in other operating environments may vary significantly. Some measurements may have been made on development-level systems and there is no guarantee that these measurements will be the same on generally available systems. Furthermore, some measurements may have been estimated through extrapolation. Actual results may vary. Users of this document should verify the applicable data for their specific environment.

This document is copyrighted by Lenovo and is not covered by any open source license, including any Linux agreement(s) which may accompany software included with this product. Lenovo may update this document at any time without notice.

For the latest information or any questions or comments, contact or visit the Lenovo Web site:

<https://pcsupport.lenovo.com>

Trademarks

Lenovo and Lenovo logo are trademarks of Lenovo. ENERGY STAR and the ENERGY STAR mark are registered trademarks owned by the U.S. Environmental Protection Agency. Intel and Thunderbolt are trademarks of Intel Corporation or its subsidiaries in the U.S. and/or other countries. NanoSaver and Cleat are trademarks or registered trademarks of ACCO Brands. Microsoft, Windows, BitLocker, and Cortana are trademarks of the Microsoft group of companies. Dolby and Dolby Audio are trademarks of Dolby Laboratories Licensing Corporation. The terms HDMI and HDMI High-Definition Multimedia Interface are trademarks or registered trademarks of HDMI Licensing LLC in the United States and other countries. Wi-Fi and Miracast are registered trademarks of Wi-Fi Alliance. USB-C® is a registered trademark of USB Implementers Forum. All other trademarks are the property of their respective owners.

Lenovo