



D190
D220

You can rely on Defy. To simplify.

EN

INSTRUCTION MANUAL

50 CM DOUBLE DOOR REFRIGERATORS

Record in the space below the listed information for future reference.

SERIAL NUMBER.....

DATE OF PURCHASE.....

PURCHASED FROM.....

.....

The manufacturer strives for continuous improvement.
For this reason, the text and illustrations in this manual
are subject to change without notice.

Part number
3803290100
Revision AG



Read this manual before initial installation and operation of the product!

Dear Customer,

Your new Defy refrigerator was manufactured in a state of the art facility and has passed the strictest quality control procedures.

Please read this manual carefully before using your product for the first time and then store it within easy reach for future reference.

We trust you will enjoy years of trouble free use.

The user manual:

- This manual will provide you with information on how to safely operate and care for your product in order that you gain the maximum benefit from it.
- Pay particular attention to any safety instructions.
- Please read all additional documents supplied with your refrigerator.
- Please note that this manual may be used for several similar but different models. Please check for relevance regarding your particular model.

Explanation of symbols used in this manual



Important safety information. Warning for hazardous situations with regard to life and property.



Caution; Warning for supply voltage.



Caution; Warning for fire hazard.



Caution; Warning for hot surfaces.



Read the instructions.



Useful information. Important information or useful hints about usage.

Unpacking

Remove all packaging.



Ensure that packing material is disposed of in a responsible manner and that any plastic bags are cut up to prevent children playing with them and accidentally suffocating.

If the refrigerator is damaged in any way do not use it. Report the damage to your dealer who will take the necessary corrective action.

	This refrigerator is not intended for use by persons (including children) with reduced physical, sensory or mental capabilities or lack of experience and knowledge, unless they have been given supervision or instruction concerning the use of the refrigerator by a person responsible for their safety.
	Children should be supervised to ensure that they do not play with the refrigerator.

Contents

<u>1. Your Refrigerator</u>	<u>4</u>	<u>4. Using your refrigerator</u>	<u>12</u>
		Temperature control and adjustment	12
		Defrosting	13
<u>2. Important Safety Information</u>	<u>5</u>	<u>5. The freezer compartment</u>	<u>14</u>
Warnings	5	Deep freeze information	14
Child safety	6	Deep Freeze packaging information	14
HCA Warning	6		
Energy saving tips	7	<u>6. Water Dispenser</u>	<u>15</u>
Placing foods	7		
		<u>7. Maintenance and cleaning</u>	<u>17</u>
<u>3. Placing and Installation</u>	<u>8</u>	<u>8. Trouble Shooting</u>	<u>18</u>
Transportation instructions	8		
Before using the refrigerator	8	<u>9. Refrigerator specifications</u>	<u>20</u>
Electrical connection	8		
Adjusting the feet	9	<u>10. Service Centres</u>	<u>21</u>
Reversing the doors	10		
		<u>11. Warranty</u>	<u>22</u>

	Figures in this manual are schematic and may not match your refrigerator exactly.
	Values stated on the machine labels or in the documentation accompanying it are obtained in laboratory conditions in accordance with the relevant standards. Depending on operational and environmental conditions of the machine, these values may vary.

1 Your Refrigerator

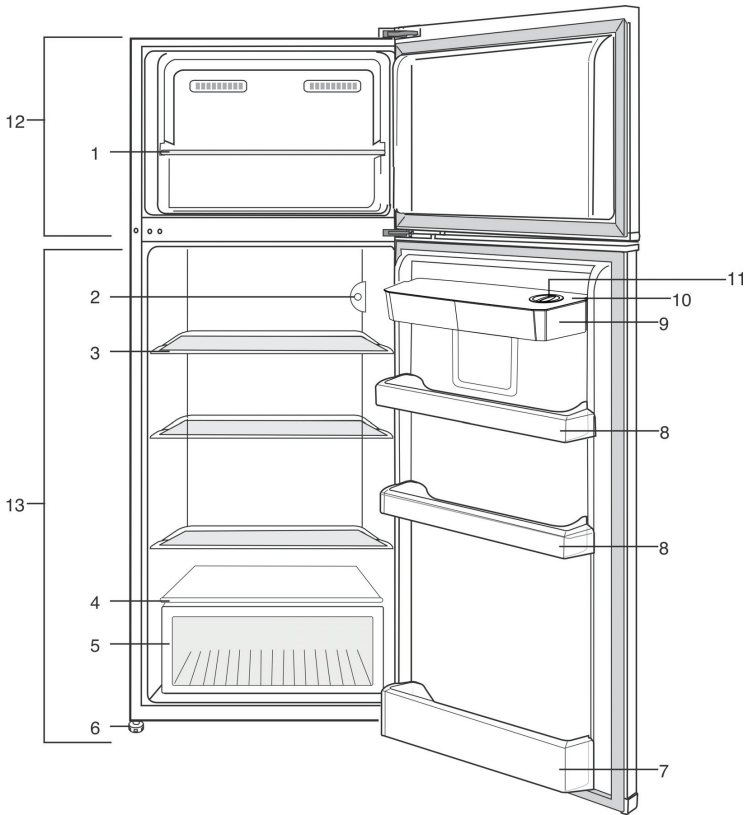

- | | |
|------------------------------|-------------------------------|
| 1. Freezer compartment shelf | 8. Fridge compartment shelves |
| 2. Thermostat knob | 9. Water dispenser tank* |
| 3. Adjustable shelves | 10. Water dispenser lid * |
| 4. Crisper glass | 11. Water dispenser plug* |
| 5. Crisper | 12. Freezer compartment |
| 6. Adjustable legs | 13. Fridge compartment |
| 7. Bottle shelf | |

*Depends on model



The manufacturer strives for continuous improvement. For this reason, technical specifications, text and illustrations in this manual are subject to change without notice.





Figures represented in this instruction manual are schematic and may not correspond exactly with your refrigerator. If the parts are not included in the refrigerator you have purchased, they may be model specific and therefore only valid for some models.



2 Important safety information

Please review and observe the following information. Failure to do so may result in injuries or material damage and will render any warranty and reliability commitments void. Spare parts for the refrigerator will be stocked for 10 years to meet any maintenance or service requirements.

Warnings

- Hand this owners manual over to the new owner should ownership change.
- The refrigerator must only be used for its intended purpose, i.e. the storing of edible foodstuff.
- The refrigerator is intended to be used in household and similar applications such as staff kitchen areas in shops, offices and other working environments; farm houses and by clients in hotels, motels and other residential type environments; bed and breakfast type environments; catering and similar non-retail applications.
- Consult with your authorised DEFY service centre for all questions and problems relating to the refrigerator. Only authorised agents are to carry out repairs.
- Vapour and vaporized cleaning materials must never be used in the cleaning and defrosting the refrigerator. The vapour may come into contact with the electrical parts and cause a short circuit or electric shock.
- Do not allow children to hang on the refrigerator door as the unit could topple forward risking personal injury. Never use the parts on your refrigerator, such as the door, as a means of support or step.
- Do not use electrical appliances inside the refrigerator or freezer.
- Keep ventilation openings, in the refrigerator or in the built-in structure, clear of obstructions.
- Unplug the refrigerator when cleaning, during routine maintenance or if it will not be used for an extended period.
- To unplug the refrigerator, remove the plug by pulling on the plug and not the cable!
- Exposing the refrigerator to rain, snow, sun and wind is an electrical safety risk.
- Should the mains lead of the refrigerator become damaged or should it need replacing at any time, it must be replaced by a special purpose made mains lead which can only be obtained from a DEFY Authorised Service Agent.
- Never connect your refrigerator to electricity saving systems as they may damage the refrigerator.
- Do not store medicine or academic research samples which require strict temperature control in the refrigerator.
- Do not store or use flammable gas, benzene, petrol or volatile substances in or near the refrigerator.
- Do not store explosive substances such as aerosol cans with a flammable propellant in the refrigerator.
- In the event of a malfunction, disconnect the refrigerator from the power supply.
- Do not overload your refrigerator with excessive amounts of food. If overloaded, the food items may fall down and injure you and damage the refrigerator when you open the door. Never place objects on top of the refrigerator, they may fall down and injure you when you open or close the refrigerator door.
- If there is a blue light fitted on the refrigerator, do not look at the blue light through optics.
- The lamp(s) used in this appliance is not suitable for household room illumination.

	Do not drill, cut or modify the refrigerator. Injuries may result if the refrigerant circuit is damaged. See HCA warning. Do not damage the refrigerant circuit.
	Repairs must be carried out by authorised persons only. Repairs carried out by incompetent persons create a user risk.

	Do not operate a damaged refrigerator. Consult with your nearest DEFY service centre should you have any concerns
	The electrical safety of the refrigerator is only guaranteed if the earth system of your home is compliant to national standards.
	Never plug the refrigerator into the wall socket during installation. Death or serious injury may result.

- The refrigerator may move if the adjustable legs are not properly levelled on the floor. Levelling the adjustable legs on the floor helps prevent the refrigerator from moving.
- When carrying the refrigerator, do not hold on the door handle as this may cause the handle to break.
- When placing your refrigerator next to another refrigerator or freezer, the distance between the devices should be at least 80 mm. Failure to do so may cause adjacent walls to humidify.
- For refrigerators with a freezer compartment; Do not put bottled and canned liquid beverages in the freezer compartment as they may burst.
- Do not touch frozen food with your hands; they may stick to your hand.
- Never pour or spray water into or on the refrigerator and do not store liquids, pot plants or open containers on top of the refrigerator as these might spill causing electrical shorting.
- For manually controlled refrigerators, wait at least 5 minutes before starting the refrigerator after a power failure.
- Avoid any damage to the power cable when transporting the refrigerator.

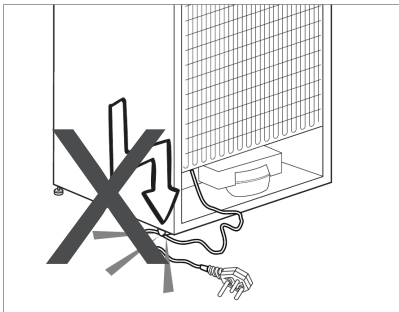

- Bending the cable may cause a fire.
- Never place heavy objects on the power cable.
- Do not touch the plug with wet hands.
- Do not plug in the refrigerator if the wall socket is loose.
- On delivery, check to make sure that the refrigerator is not damaged and that all the parts and accessories are in perfect condition.
- Ensure that the plug remains readily accessible. Do not use multiple adapter plugs or an extension cable.

- Ensure that there is sufficient spacing between the refrigerator and surrounding walls.
- Unplug the refrigerator from the mains when you clean the refrigerator.

⚠ Child safety

- If the door has a lock, the key should be kept out of reach from children.
- If you are discarding an old refrigerator with a lock or latch fitted to the door, disable the lock/latch, and ensure that the refrigerator is left in a safe condition to prevent children from being trapped inside and suffocating.
- Children must be supervised to prevent them from tampering with the refrigerator.



⚠ HCA Warning

Refrigerator cooling systems containing R600a:

At DEFY, the care and protection of our environment is an on going commitment. This DEFY refrigerator is particularly environmentally friendly and contains non CFC / HFC natural substances in the cooling system (Called R600a) and in the insulation (Called cyclopentane). These are potentially flammable if exposed to fire. Take care not to damage, the cooling circuit / pipes of the refrigerator in transportation and in use.

In case of damage do not expose the refrigerator to fire or potential ignition sources and immediately ventilate the room where the refrigerator is situated.



Ignore this warning if your refrigerators cooling system contains R134a.

	Warning: Never dispose of the Refrigerator in a fire.
	Do not dispose of your Refrigerator along with regular household waste.
	Contact your local authority for disposal information and facilities available.

Energy saving tips

- Ensure your refrigerator is installed in a well ventilated area. If the ambient temperature is low (but in no case lower than 5 degrees C), then the energy saving will be more. Do not install your refrigerator under direct sunlight or near heat emitting appliances such as ovens, dishwashers or radiators. Keep food in closed containers.
- Ensure the time between buying chilled/ frozen food and placing it in the refrigerator is kept at a minimum, particularly in summer. Use a cooler bag or a special carrier bag to carry frozen food. Do not put hot food or drinks in the refrigerator.
- Do not leave the door(s) of the refrigerator open for long and ensure they are closed properly after each opening.
- Defrost your refrigerator regularly.
- Defrost frozen food in the fridge compartment, so that frozen food acts as an ice pack to assist cooling in the fridge. This will provide energy saving and preserve the food quality.
- Do not put hot food or drinks in your refrigerator.
- Do not overload your refrigerator. This restricts effective air circulation in the refrigerator.
- Pay attention to keep your food in closed containers.

Placing foods	
Freezer compartment shelves.	Various frozen food such as meat, fish, ice cream, and vegetables.
Egg holder.	Eggs.
Fridge compartment shelves.	Food in pans, covered plates and closed containers.
Fridge compartment door shelves.	Small and packaged food or drinks (such as milk and fruit juice). Delicatessen products (cheese and butter).
Crisper.	Vegetables and fruits.

	Values stated in the documentation are obtained in laboratory conditions in accordance with the relevant standards. Depending on operational and environmental conditions of the refrigerator, these values may vary.
	If your refrigerator is not going to be used for a long period of time, unplug the power cable, remove all food, clean it and leave the door ajar.

3 Placing and Installation

Transportation instructions

1. The refrigerator must be transported only in an upright position. The packing must be intact during transportation.
2. When positioning your refrigerator, take care not to damage flooring, pipes, wall coverings etc. Do not move the refrigerator by pulling the door or handle.

When re-transporting your refrigerator

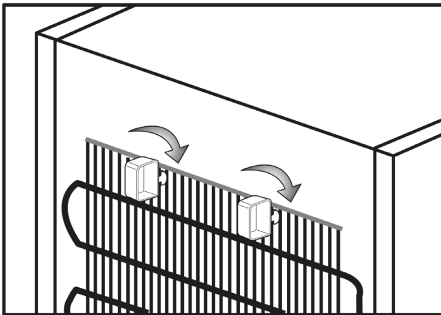

- Your refrigerator must be emptied and cleaned prior to any transportation.
- The shelves, accessories, crisper etc. In your refrigerator must be fastened securely with adhesive tape to protect against any jolts.
- Packaging must be tied with thick tape and strong rope and the transportation guidelines printed on the package must be followed.

1. Install your refrigerator in a place that allows for ease of use.
2. Keep your refrigerator away from heat sources such as stoves, geysers humid places and direct sunlight.
3. There must be appropriate air ventilation around your refrigerator in order to achieve efficient operation. The refrigerator is to have at least a 50 mm space from the ceiling and at least a 50 mm space from the wall. Fit the Two plastic wall spacers supplied with the appliance rotating 1/4 turn to the condenser at the back of the appliance (See Diagram).



If the floor is covered with a carpet, your refrigerator must be elevated 25 mm from the floor.

4. Place your refrigerator on an even floor surface to prevent jolts.
 5. Do not keep your refrigerator in ambient temperatures under 10°C.
- Please make sure that the interior of your refrigerator is cleaned thoroughly.

	Your refrigerator should be installed at least 30 cm away from heat sources such as hobs, ovens, central heaters and stoves and at least 5 cm away from electrical ovens and should not be located under direct sunlight.
	
	If two refrigerators are to be installed side by side, there should be at least 8 cm distance between them.

Before using the refrigerator check that:

1. The feet have been adjusted for perfect levelling.
2. The interior of the refrigerator is clean and dry.
3. Check the required distance between your refrigerator and the wall in order to allow for free air circulation.
4. The plug has been inserted into the wall socket and the electricity is switched on. When the door is open the interior light will come on.
5. You may hear a noise as the compressor starts up. The liquid and gases sealed within the refrigeration system may also give rise to noise, even if the compressor is not running, this is quite normal.
6. Do not load the refrigerator immediately after it is switched on. Wait until the correct storage temperature has been reached.

Electrical connection

Connect your refrigerator to a grounded socket which is protected by a fuse with the appropriate capacity.

Important

The connection must be in compliance with national regulations. The power cable plug must be easily accessible after installation. The specified voltage must be equal to your mains voltage.

When operating your refrigerator for the first time, please observe the following instructions during the initial six hours:

- The door should not be opened frequently.
- The refrigerator must be operated empty without any food in it.
- Do not unplug your refrigerator.
- Original packaging and foam materials should be kept for any future transportation or moving.

Please remember that the manufacturer shall not be held liable if the information given in the instruction manual is not followed.







Adjusting the feet

The refrigerator may move if the adjustable legs are not properly levelled on the floor.

Levelling the adjustable legs on the floor:
Level your refrigerator by turning the front legs as shown in the illustration below.

The corner where the legs are is lowered when the leg is turned in the direction of the black arrow and raised when turned in the opposite direction.

Having someone to carefully assist in tilting the refrigerator slightly will help facilitate this process.

	The front edges of the refrigerator may feel warm. This is normal. These areas are designed to be warm in order to avoid condensation.
	A damaged power cable must be replaced by a qualified electrician.
	Extension cables and multiway plugs must not be used for connection.
	A damaged refrigerator must not be operated before it is repaired! There is danger of an electric shock!
	Important! Care must be taken while cleaning/carrying the refrigerator not to touch the bottom of the condenser metal wires at the back of the refrigerator, as this could cause injury.
	DEFY declines to accept any liability should the instructions not be followed.

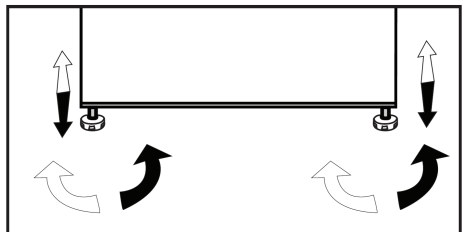

Reversing The Doors

We recommend that you reverse doors (if required) before switching on for the first time.

Tools required:

Small and medium size screwdrivers and a pair of pliers.

Spare Parts:

The following parts, which are exclusively for left hand side fitted hinge operation, are available from a Defy spares outlet:

Upper door top trim hinge covers – there are 2 different parts, one for each side of the top trim.

Upper door middle hinge bushing/ door stopper assembly.

Keep all the parts which have been removed when reversing the doors in a safe place for possible future re-use.



Important: Have somebody to assist you when moving the refrigerator and to hold the doors when removing / re-fitting hinges and doors to avoid injury and damage to the product

Please refer to diagrams supplied.



Figures represented in this instruction manual are schematic and may not correspond exactly with your refrigerator.

If the parts are not included in the refrigerator you have purchased, they may be model specific and therefore only valid for some models.

Reversing the doors

Proceed in numerical order

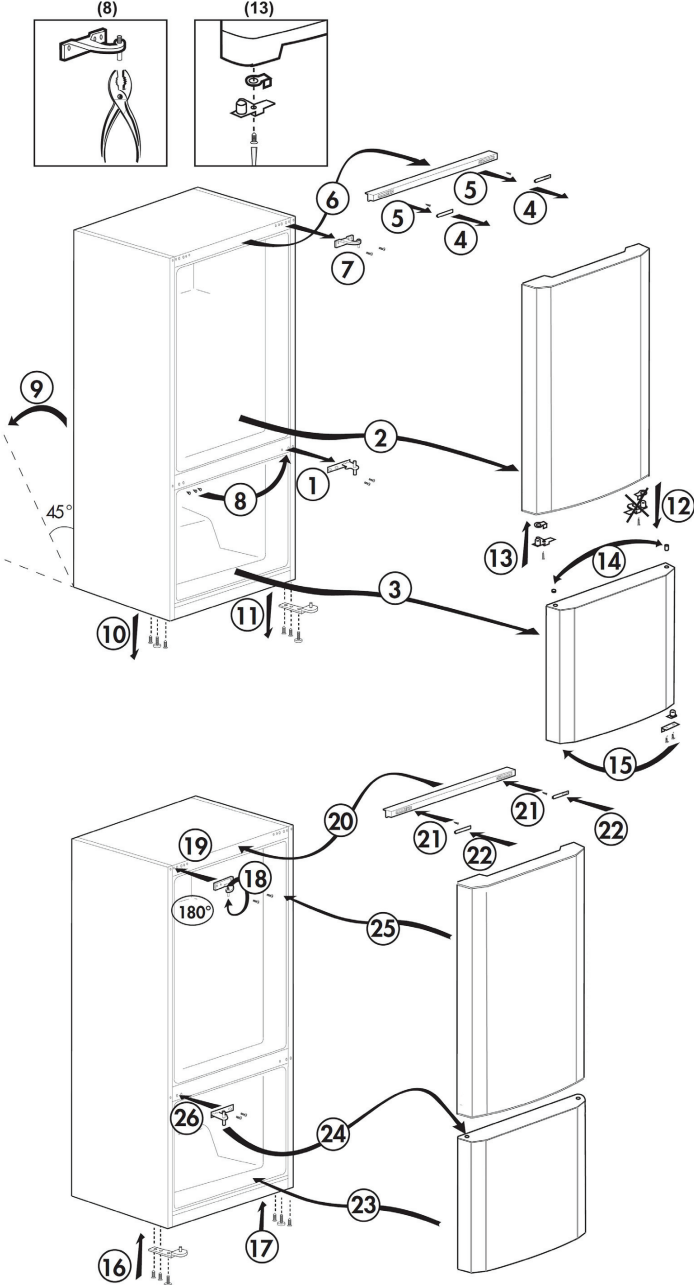

4 Using your refrigerator

Temperature control and adjustment

Operating temperatures are controlled by the thermostat knob (see diagram) located on the ceiling of the fridge compartment. Settings may be made from 1 to 5, 5 being the coldest position.

When the appliance is switched on for the first time, the thermostat should be adjusted so that after 24 hours, the average fridge temperature is no higher than +5°C.

Set the thermostat half way between the 1 and 5 setting and monitor to obtain the desired temperature i. e. towards 5 you will obtain a colder fridge temperature and vice versa. Some sections of the fridge may be cooler or warmer. (such as the salad crisper and the top part of the cabinet). This is quite normal.

The normal storage temperature of the freezer should be -18°C. Lower temperatures may be obtained by adjusting the thermostat knob towards position 5.

Check the temperature with an accurate thermometer to ensure that the storage compartments are kept to the desired temperature. Remember to take the reading very quickly since the thermometer temperature will rise very rapidly after it has been removed from the freezer.

Each time the door is opened cold air escapes and the internal temperature rises. Therefore never leave the door open and ensure it is closed immediately after food is added or removed.

In case of a temporary ice build up in the fridge compartment, reduce the thermostat setting to 1, monitoring at the same time that the fridge temperature is maximum +5 degrees C. Once the ice build up disappears and the refrigerator starts auto defrosting again as normal, then you may increase the thermostat setting, if required.



Figures represented in this instruction manual are schematic and may not correspond exactly with your refrigerator. If the parts are not included in the refrigerator you have purchased, they may be model specific and therefore only valid for some models.

Defrosting

Fridge compartment

The fridge compartment defrosts automatically.

The defrosting water runs to the drain tube via a collection container at the back of the appliance (1). (See diagram).

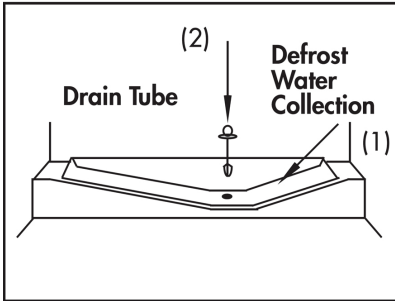

During defrosting water droplets may form at the back of the fridge compartment where the concealed evaporator is located.

Some droplets may remain on the liner and refreeze when defrosting is completed.

Do not use pointed or sharp edged objects such as knives or forks to remove the droplets which have frozen.

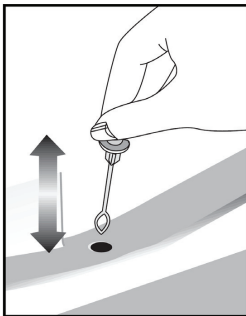

If at any time the defrost water does not drain from the collection channel, check to ensure that no food particles have blocked the drain tube.

The drain tube can be cleared by pushing the special plastic plunger provided down the drain tube (2). If the frost layer reaches about 7 mm, reduce the setting (i.e. from 4 to 1) to restart automatic defrosting.

Defrosting

Freezer compartment

Defrosting is very easy and without mess due to a dedicated defrost collection basin. Defrost twice a year or when a frost layer of around 7 mm (1/4") has formed.

To start the defrosting procedure switch off the refrigerator at the wall socket and pull out the mains plug. All food should be wrapped in several layers of newspaper and stored in a cool place (e.g. fridge or larder).

Remove all freezer drawers. Containers full of warm water may be placed carefully in the freezer to speed up the defrosting process.

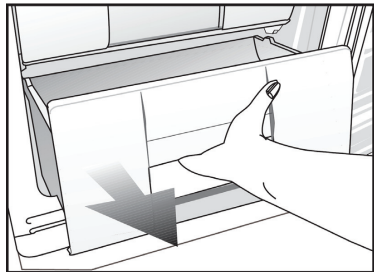

Do not use pointed or sharp edged objects such as knives or forks to remove the frost.

Never use hairdryers, electrical heaters and other similar electrical appliances for defrosting.

When defrosting has finished, sponge out any defrost water which collects at the bottom of the freezer and dry the interior thoroughly.

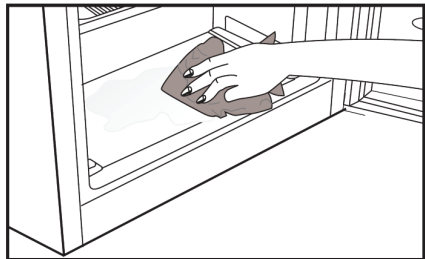

Insert the plug in to the wall socket and switch on the electricity supply.

5 The freezer compartment

Deep-freeze information

- Food must be frozen as rapidly as possible when placed in a freezer to maintain its quality.
- It is possible to keep food for a long time period only at temperatures of -18 degrees C or lower.
- The quality of food in a freezer can be maintained for many months at temperatures of -18 degrees C or lower.
- Pre-packed commercially frozen food should be stored in accordance with the frozen food manufacturer's instructions for a (4 star) frozen food storage compartment.
- To ensure that the high quality achieved by the frozen food manufacturer and the food retailer is maintained, the following should be remembered:

Put packages in the freezer as quickly as possible after purchase. Ensure that contents are labelled and dated. Do not exceed "Use By" or "Best Before" dates on the packaging.

If there is a power failure do not open the freezer door. Even if the power failure lasts up to the "Temperature rise time", frozen food will not be affected. In case the failure lasts longer, the food must be checked and when necessary, must be consumed immediately or must be frozen after being cooked.

- Wrap all food before storage. Seal all foods, or place in airtight containers to prevent dehydration.
- Eliminate all the air pockets from packages and keep air out by firm sealing.
- When packaging in sheet material such as aluminium foil, parcel tightly and press out all air pockets. All folds should be sealed with deep-freeze sealing tape.
- Unwrapped food containing acids or salt may permanently stain the cabinet interior.
- When loading bulk into the freezer, load one quarter at a time and allow to freeze before loading the next quarter.
- Divide food into reasonable portions according to your requirements.





- Allow hot food to cool before putting it into the freezer. Freeze cooked food in small quantities. This ensures rapid freezing and maintains the quality of the food.
- Always use appropriate packaging material to avoid odour penetration or degradation of the food.
- Transport pre-frozen food from the supermarket in foil lined cooler bags and transfer to the home freezer as soon as possible.
- Place fresh food to be frozen near the side walls of the freezer to ensure fast freezing.
- Never exceed the maximum freezing capacity of the freezer.
- Do not freeze too large a quantity of food at any one time. The quality of the food is best preserved when it is frozen right through to the centre as quickly as possible.
- Take special care not to mix already frozen food and fresh food.

Deep Freeze packaging information

Materials to be used for packaging must be tear-proof and resistant to cold, humidity, odour, oils and acids and they must also be airtight. They must be made from materials that are suitable for deep freeze usage.

Materials necessary for packaging

Cold resistant adhesive tape, Self adhesive labels, Rubber rings and a Pen.

	Food that has defrosted must be consumed within 24 hours. Only cooked food can be refrozen. Do not re-freeze food that has defrosted.
	Do not exceed the expiry date shown on food packs.
	Do not take out frozen food with wet hands. Your hands could stick to the frozen food.
	Note: If the door of the freezer is difficult to open just after being closed, this is due to the pressure difference which will equalize and allow for the door to be opened normally after a few minutes.

6 Water Dispenser (Some models)

The water dispenser is a very useful feature with regards to accessing chilled water without having to open the door of your fridge.

Since you do not have to open the door of your fridge frequently, you also save on electricity.

Using the water dispenser

Push in the lever of the water dispenser with your glass for water flow. Releasing the lever cuts off the water flow.

When operating the water dispenser, maximum flow is achieved by fully depressing the lever.

Please note, how much water flows from the dispenser depends on how far you depress the lever. As the level of water in your cup / glass rises, gently reduce the amount of pressure on the lever to avoid overflow.

If you depress the lever by a small amount, then the water will only trickle; this is perfectly normal and is not a fault .

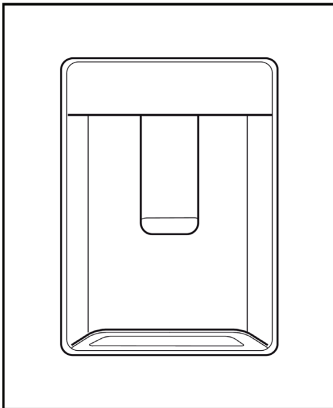

Filling the water dispenser's tank

The water tank filling tank is located inside the door rack. Remove the tank plug and fill up with pure and clean drinking water. Refit the tank plug.

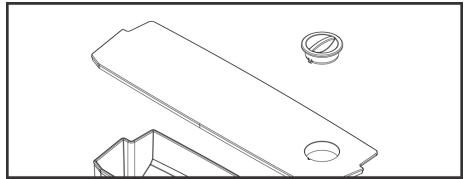
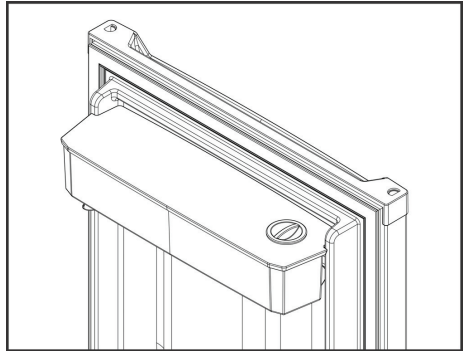

Warning!

Do not fill the water tank with any liquid other than drinking water; beverages such as fruit juice, carbonated beverages and alcoholic drinks are not suitable for use with the water dispenser.

If such liquids are used, the water dispenser will malfunction and may be damaged beyond repair. The warranty does not cover such usage. Some of the ingredients and additives in these drinks / beverages may also attack and damage the water tank material.

Use clean and pure drinking water only.

Capacity of the water tank is 2.0 litres; **do not overflow.**

Push the arm of the water dispenser with a rigid glass. If you are using disposable plastic glasses, push the arm with your fingers from behind the glass.



WARNING: Do not wash any of the water tank parts in a dishwashing machine.

Cleaning the water tank

- Remove the water dispenser shelf by holding from both sides.

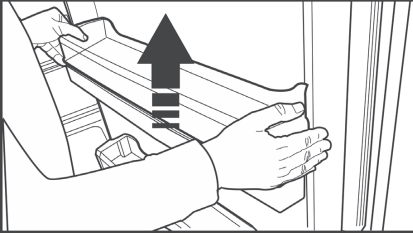

- Grab the water dispenser reservoir on both sides & remove it at an angle of 45°.

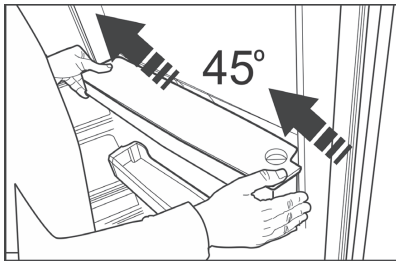

- Clean the reservoir by removing its lid.

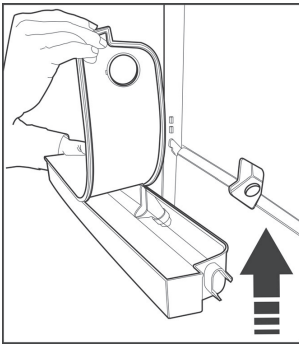

Make sure that the parts and seals removed (if any) as illustrated in the exploded diagram during cleaning are properly refitted to prevent any water leakage.

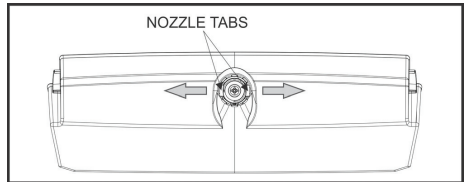
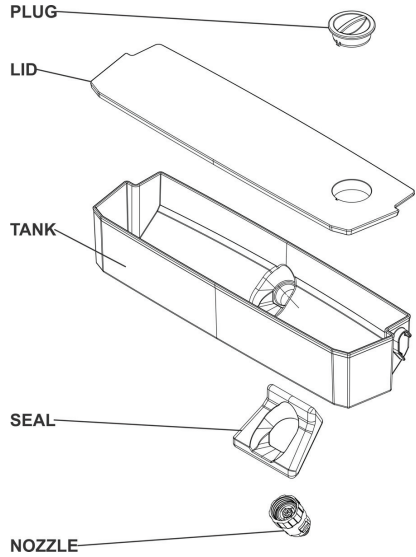

i When fastening the nozzle, please ensure that the nozzle tabs are horizontally aligned with the dispenser housing.

Water tray

Any water that drips whilst using the water dispenser accumulates in the spillage tray. Remove the plastic strainer by pressing on the side as shown in the figure. With a clean and dry cloth, remove the water that has accumulated.

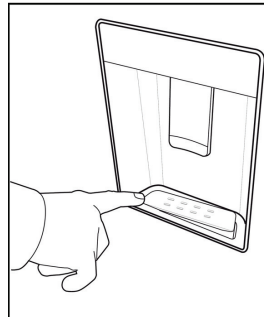

7 Maintenance and Cleaning

1. Always disconnect the plug from the mains socket before cleaning.

2. Never use any sharp instruments or abrasive substances, soap, household cleaner, detergent or wax polish for cleaning.

3. Use luke warm water to clean the cabinet of the refrigerator and wipe it dry.

4. Use a damp cloth wrung out in a solution of one teaspoon of bicarbonate of soda to two litres of water to clean the interior and wipe it dry with a soft cloth.

5. Make sure that no water enters the temperature control box or lamp housing and other electrical items.

6. If the refrigerator is not going to be used for a long period of time, switch it off and unplug the power cable, remove all food, clean it and leave the door ajar.

7. Any dust that gathers on the condenser, which is located at the back of the refrigerator, should be removed once a year with a vacuum cleaner or dusted using a soft bristle brush.

8. Check door seals regularly to ensure they are clean and free from food particles.

9. Never:

- Clean the refrigerator with unsuitable material; e.g. petroleum based products.
- Subject it to high temperatures in any way,
- Scour, rub etc., with abrasive material.

10. Always ensure that the defrost drain, located below the back wall evaporator in the refrigerator section, is clean and free from obstructions.

11. Shelves and freezer baskets may be removed for cleaning purposes. Replace baskets in original positions. To remove a freezer drawer, pull it as far as possible, tilt it upwards and then pull it out completely.

12. There is no need to defrost semi no frost models, the freezer defrosts automatically. For static models see defrosting.

Protection of plastic surfaces

Do not place liquid oils or oil-cooked meals in your refrigerator in unsealed containers as they may damage the plastic surfaces.

In case of spilling or smearing oil on the plastic surfaces, clean and rinse the relevant part of the surface at once with warm water.

Replacing the light bulb

1. Switch off at the wall socket and pull out the mains plug.

- Shelves may be removed for easy access.

2. Use a flat tipped screwdriver to remove the light diffuser cover by inserting the blade into the recess to prise the cover off.

3. First check that the bulb is not loose by ensuring it is securely screwed into the holder. Refit the plug and switch on. If the bulb works, replace the light cover by inserting the rear lug and pushing up to locate the front two lugs.

4. If the light still fails to work, switch off at the wall socket and pull out the mains plug. Replace the bulb with a new 15 watt (max) screw cap (SES) bulb.

5. Carefully dispose of the burnt-out light bulb.

A replacement light bulb can be obtained from a good local electrical or DIY store.



Warning: Do not damage the refrigerant circuit. Do not use electrical appliances inside the food storage compartments of the refrigerator, unless they have been recommended by the manufacturer.

8 Trouble Shooting

Please review this list before calling a service centre. It could save you time and money. This list includes frequent complaints that do not arise from defective workmanship or material usage. Some of the features described here may not apply to your model.

Symptom	Check
The refrigerator does not operate.	<ul style="list-style-type: none"> • Make sure the refrigerator plug is securely plugged in. • Check for a blown fuse or tripped circuit breaker. • Test the wall socket for power using another appliance. • Inspect the electrical cord for damage. • Eliminate the use of an extension cord, if any is being used.
Condensation on the side wall of the fridge compartment.	<ul style="list-style-type: none"> • Very cold ambient conditions. Frequent opening and closing of the door. Highly humid ambient conditions. Storage of food containing liquid in open containers. Leaving the door ajar. Switching the thermostat to a colder degree. • Decreasing the amount of time the door is left open or using it less frequently. • Covering the food stored in open containers with a suitable material. • Wipe the condensation using a dry cloth and check if it persists.
Compressor is not running.	<ul style="list-style-type: none"> • The protective thermal relay of the compressor will blow out during sudden power failures or plug-outs and plug-ins as the refrigerant pressure in the cooling system of the refrigerator has not yet been balanced. Your refrigerator will start running approximately after 15 minutes. Please call a service centre if the refrigerator does not start up at the end of this period. • The refrigerator is in defrost cycle. This is normal for an automatic defrosting refrigerator. The defrosting cycle occurs periodically. • Your refrigerator is not plugged into the wall socket. Make sure that the plug is properly fitted into the wall socket. • Have the temperature adjustments been correctly made? • Power might be cut off.
Condensation on the inner walls of refrigerator.	<ul style="list-style-type: none"> • Hot and humid weather increases icing and condensation. It is normal and not a fault. • Doors might have been left ajar; ensure the doors are fully closed. • Doors might have been opened frequently or left ajar for a long time; open them less frequently.
Food kept in the fridge compartment drawers are freezing.	<ul style="list-style-type: none"> • The fridge temperature might have been adjusted to a very low temperature. Adjust the fridge temperature to a warmer degree and check.
Freezer temperature is very low while the fridge temperature is sufficient.	<ul style="list-style-type: none"> • The freezer temperature is adjusted to a very low temperature. Adjust the freezer temperature to a warmer degree and check.

Symptom	Check
Fridge temperature is very low while the freezer temperature is sufficient.	<ul style="list-style-type: none"> • The fridge temperature might have been adjusted to a very low temperature. Adjust the fridge temperature to a warmer degree and check.
Temperature in the fridge or freezer is very high.	<ul style="list-style-type: none"> • The fridge temperature might have been adjusted to a very high degree. Fridge adjustment has an effect on the temperature of the freezer. Change the temperature of the fridge or freezer until the fridge or freezer temperature reaches a sufficient level. • Doors might have been opened frequently or left ajar for a long time; open them less frequently. • Door might have been left ajar; close the door completely. • Large amount of hot food might have been put in the refrigerator recently. Wait until the fridge or freezer reaches the desired temperature. • The refrigerator might have been plugged in recently. Complete cooling down of the refrigerator takes time.
The fridge is running continuously or for a long time.	<ul style="list-style-type: none"> • Your new refrigerator may be wider than the previous one. This is quite normal. Large refrigerators operate for a longer period of time. • The ambient room temperature may be high. This is quite normal. • The refrigerator might have been plugged in recently or might have been loaded with food. Cooling down of the refrigerator completely may last for a couple of hours longer. • Large amounts of hot food might have been put in the refrigerator recently. Hot food causes longer running of the refrigerator until the food has cooled down. • Doors might have been opened frequently or left ajar for a long time. The warm air that has entered into the refrigerator causes the refrigerator to run for longer periods. Open the doors less frequently. • The freezer or fridge compartment door might have been left ajar. Check that the doors are tightly closed. • The refrigerator is adjusted to a very low temperature. Adjust the refrigerator temperature to a warmer degree and wait until the temperature is achieved. • The door seal of the fridge or freezer may be soiled, worn out, broken or not properly seated. Clean or replace the seal. A damaged/broken seal causes the refrigerator to run for a longer period of time in order to maintain the current temperature.
Humidity occurs on the outside of the refrigerator or between the doors.	<ul style="list-style-type: none"> • There might be humidity in the air; this is quite normal in humid weather. When the humidity is less, condensation will disappear.
Bad odour inside the refrigerator.	<ul style="list-style-type: none"> • The inside of the refrigerator must be cleaned. Clean the inside of the refrigerator with a sponge, lukewarm water or carbonated water. • Some containers or package materials might cause the smell. Use a different container or different brand of packaging material.

Symptom	Check
Crispers are stuck.	<ul style="list-style-type: none"> • The food might be touching the ceiling of the drawer. Rearrange the food in the drawer.
The door is not closing.	<ul style="list-style-type: none"> • Food packages may prevent the door's closing. Repack the packages that are obstructing the door. • The refrigerator is not completely level on the floor and rocks when slightly moved. Adjust the elevation screws. • The floor is not level or strong. Make sure that the floor is level and capable of carrying the weight of the refrigerator.

	<p>Warning: Repairs must be carried out by authorised persons only. Repairs carried out by incompetent persons create a user risk.</p>
--	---

	<p>DANGER! Always disconnect the plug from the wall socket before any maintenance or cleaning.</p>
---	---

Owner's responsibility

Do not damage the refrigerant circuit.

Do not use electrical appliances inside the food storage compartments of the appliance, unless they have been recommended by the manufacturer.

Since the following are not factory faults they are the owners responsibility:

- Damage to the exterior finish.
- Breakage of glass and other components.
- Replacement of light bulbs.
- Damage caused through improper use of the appliance.
- Damage caused by moving the appliance.

9 Refrigerator specifications

MODEL	D190	D220	D220WD
APPLIANCE TYPE	FRIDGE	FRIDGE	FRIDGE
Total gross volume (l)	158	183	181
Net volume (l)	151	176	174
Dimensions (HxWxD) mm	1450 x 495 x 525	1630 x 495 x 525	1630 x 495 x 525
Climate class	SN	SN	SN
Refrigerant	R600a	R600a	R600a

Service Centres

If you have followed the instructions and still have a problem, contact the nearest Defy Service Centre. They will be able to advise you on any aspect of the product or send a qualified technician to repair it.

South African Service Agents:

BLOEMFONTEIN

160 Long Street, Hilton, Bloemfontein 9301
Tel: 051 400 3900

Bloemfontein.Service@defy.co.za

CAPE TOWN

5A Marconi Rd. Montague Gardens, 7441
Tel: 021 526 3000

CapeTown.Service@defy.co.za

DURBAN

35 Intersite Avenue, Umgeni Business Park,
Durban, 4051

Tel: 031 268 3300

Durban.Service@defy.co.za

EAST LONDON

Robbie de Lange Road, Wilsonia,
East London, 5201

Tel 043 745 1129

EastLondon.Service@defy.co.za

JOHANNESBURG

Cnr. Mimetes & Kruger Sts. Denver ext.12
Johannesburg, 2094

Tel: 011 621 0200 or 011 621 0300

Gauteng.Service@defy.co.za

POLOKWANE

87 Nelson Mandela Drive, Superbia 0699
Tel: 0152 92 1166 / 7 / 8 / 9

Polokwane.Service@defy.co.za

PORT ELIZABETH

112 Patterson Road, North End, Port Elizabeth
6001

Tel: 041 401 6400

PortElizabeth.Service@defy.co.za

PRETORIA

Block A1 Old Mutual Industrial Park,
Cnr. D.F.Malan Drive & Moot Str. Hermanstad,
0082

Tel: 012 377 8300

Pretoria.Service@defy.co.za

Sub-Saharan Africa Service Agents:

ZAMBIA: SOUTHGATE INVESTMENTS LTD

Plot 1606, Sheki Sheki Road
P.O. Box 33681

Lusaka, 10101, Zambia

Tel: +260 0211 242332/3

Fax: +260 0211 242933

sgiservicecentre@microlink.zm

NAMIBIA: ATLANTIC DISTRIBUTORS (PTY) LTD

10 Tienie Louw Street, Northern Industrial Area
P.O. Box 21158, Windhoek, Namibia

Tel: (061) 216162

Fax: (061) 216134

atlantic@mweb.com.na

ZIMBABWE: TRADECOMAFRICA

Trade Com Africa, 183 Loreley Crescent
Msasa, Harare, Zimbabwe

Tel: +263 4 486165/6

Cell: +263 772 469010

Cell: +263 772 469011

BOTSWANA: RAY MORGAN AGENCIES

RMA Service Centre, Plot 48, East Gate
Gaborone International Commerce Park
Kgale View, Gaborone
Botswana

Tel: +267 390 3996 / 390 3912

Fax: +267 318 7376

Cell: +267 7134 6539

service@rma.co.bw; raja@rma.co.bw

SWAZILAND: LYNDS DISTRIBUTORS

P.O Box 716, Mbabane, Swaziland, H100

Tel: (00268) 2515 4310/8

Fax: (00268) 2518 4318

MOZAMBIQUE: COOL WORLD. LDA

Rua da Resistencia No. 97B R/C

Cell: +258 84 44 61 234

coolworldlda@hotmail.com

Nosso Show Room

Av: da Industrias, Parcela No.735 * 735A

Machava, Maputo

**OTHER AREAS ARE SERVICED BY OVER 200 AUTHORISED SERVICE AGENTS.
PLEASE CONSULT THE NEAREST REGIONAL DEFY SERVICE CENTRE FOR DETAILS.**

11 Warranty

This certificate is issued by DEFY APPLIANCES (PTY) LIMITED manufacturers of Defy and Ocean products, hereinafter the Company, to the original purchaser only, of the appliance described on the certificate and shall constitute the only warranty given in respect of this appliance.

The Company warrants to the original purchaser that for a period of TWO YEARS from date of purchase the appliance is free from defect under normal domestic use, both in workmanship and material, subject to the following conditions.

1. Repair or replacement of any part of this appliance, found by the Company to be defective, shall be at the election of the Company. The Company reserves the right to effect such service through any of its Service Divisions or Authorised Service Dealers. The cost of such service shall be borne by the Company in full, provided that the appliance is located no further than 50km from a Company Service Centre or an Authorised Service Dealer. Where the appliance is located beyond the 50km radius, the purchaser shall be liable for the standard travelling charges, as determined by the Company.
2. Vitreous enamelware, fuses and lamps are specifically excluded from these warranties. It is an express condition of these warranties that the purchaser takes due care and attention in the use and maintenance of the appliance. Abuse, misuse in conflict with operating instructions, connection to incorrect voltages and subjection to commercial use shall release the Company from its obligations.
3. This warranty shall become void and cease to operate if the appliance is dismantled by, or any repairs to the appliance are effected by any persons not duly authorised by the Company, or if substitute parts not approved by the Company are used in the appliance, or if the serial number of the appliance is removed.
4. The Company shall not be responsible for damages resulting from fire, flood, civil disturbances or any Act of God. The Company shall not, in terms of these warranties be responsible nor held liable for any consequential loss or damage of any kind caused by or due to the failure or malfunction of the appliance.
5. The Company shall not be responsible for transportation or other costs other than those incurred within the provisions of Point 1 of this Certificate.
6. **For warranties in the Republic of South Africa and Sub-Saharan Africa, please contact your nearest Defy office. Please refer to the previous page for respective South African service agents and Sub-Saharan Africa service agents.**
7. Where service is requested under warranty and no fault or defect can be found by the Company, all costs incurred will be for the purchaser's account.
8. This Certificate as well as your invoice will serve as proof of purchase. For the purpose of warranty, it will be essential to produce this Certificate and invoice. Failure to do so, will render the purchaser liable for service costs.

**KEEP THIS CERTIFICATE AND SALES INVOICE AS PROOF OF
PURCHASE FOR WARRANTY PURPOSES.**