

**DHD398-DHD399-DHD415**  
**SLIMLINE SOLID CP HOB B/SS**



Believe in better



**Customer Care Line**  
(after sales service)

**086 100 3339**

**Part number: 069858**

**Cooking**  
Instruction manual

# Contents

---

<b><u>1. General information</u></b>	<b>4</b>	<b><u>4. Preparation</u></b>	<b>14</b>
Overview	4	Tips for energy saving	14
Technical Specifications	5	Initial use	14
		First cleaning of the appliance	14
<b><u>2. Important Safety Instructions</u></b>	<b>6</b>	<b><u>5. How to use the hob</u></b>	<b>15</b>
General safety	6	General information about cooking	15
Electrical safety	6	Using the hob	15
Product safety	7	Using hotplates	15
Intended use	8		
Safety for children	8		
<b><u>3. Installation</u></b>	<b>9</b>	<b><u>6. Maintenance and care</u></b>	<b>17</b>
Before installation	9	General information	17
Installation and connection	10	Cleaning the hob	17
Package information	13	<b><u>7. Trouble Shooting</u></b>	<b>18</b>
Future transportation	13		
Disposing of an old hob	13	<b><u>8. Branches</u></b>	<b>19</b>
		<b><u>9. Warranty</u></b>	<b>20</b>

Dear Customer,

Your new Defy hob was manufactured in a state of the art facility and has passed the strictest quality control procedures.

Please read this manual carefully before using your hob for the first time and then store it within easy reach for future reference.

This manual will provide you with information on how to operate and care for your hob to gain the maximum benefit from it.

We trust you will enjoy years of trouble free use.

### **EXPLANATION OF SYMBOLS**



Important information



Warning—Hazardous situations



Warning—Electric shock



Caution; Warning for fire hazard



Caution; Warning for hot surfaces

# 1 General Information

## Overview

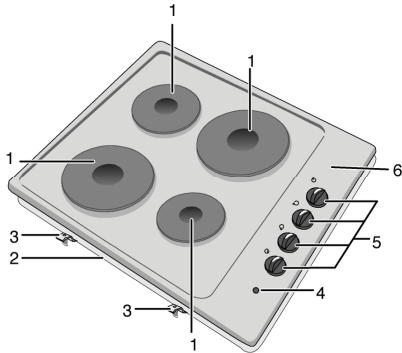

- |          |                |          |                |
|----------|----------------|----------|----------------|
| <b>1</b> | Hotplate       | <b>4</b> | Warning lamp   |
| <b>2</b> | Base cover     | <b>5</b> | Hotplates knob |
| <b>3</b> | Assembly clamp | <b>6</b> | Burner plate   |

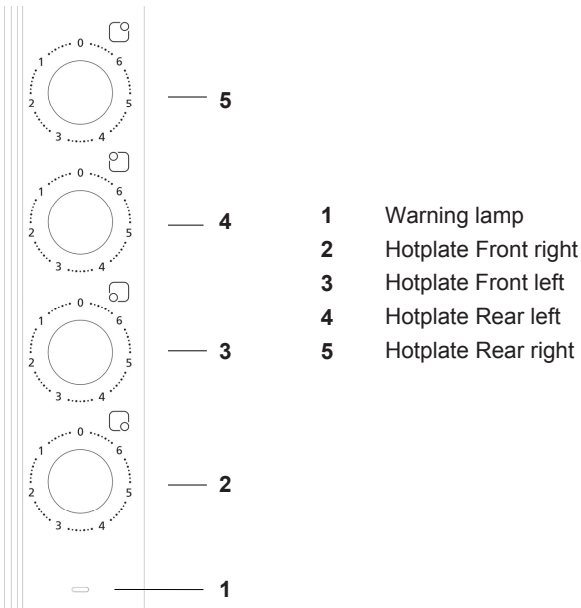

Figures in this manual are schematic and may not exactly match your product.

## 2 Technical Specifications

Voltage / frequency	220-240 V ~ 50 Hz
Total power consumption	5000 W
Circuit breaker	min. 25 A
Cable type / section	H05V2V2-F 3 x 2,5 mm <sup>2</sup> or equivalent
External dimensions (height / width / depth)	60 mm / 580 mm / 510 mm
Installation dimensions (width / depth)	560 mm / 480 mm
<b>Burners</b>	<b>Burners</b>
Front right	<b>Hotplate</b>
Dimension	145 mm
Power	1000 W
Front left	<b>Hotplate</b>
Dimension	180 mm
Power	1500 W
Rear left	<b>Hotplate</b>
Dimension	145 mm
Power	1000 W
Rear right	<b>Hotplate</b>
Dimension	180 mm
Power	1500 W

	The manufacturer strives for continuous improvement. For this reason, the text and illustrations in this manual are subject to change without notice.
	Figures in this manual are schematic and may not exactly match your product.
	Values stated on the product labels or in the documentation accompanying it are obtained in laboratory conditions in accordance with relevant standards. Depending on operational and environmental conditions of the product, these values may vary.

### 3 Important safety instructions

---

This section contains safety instructions that will help you avoid risk of injury and damage. All warranties will become void if you do not follow these instructions.

#### **General safety**

- This hob is not intended for use by persons (including children) with reduced physical, sensory or mental capabilities or lack of experience and knowledge, unless they have been given supervision or instruction concerning the use of the hob by a person responsible for their safety.
- Children must be supervised to prevent them from tampering with the product.
- Installation and repair procedures must always be performed by Authorized Service Agents. The manufacturer shall not be held responsible for damages arising from procedures carried out by unauthorized persons which may also void the warranty. Before installation, read the instructions carefully.
- Do not operate the product if it is defective or has any visible damage.
- Ensure that the product function knobs are switched off after every use.

#### **Electrical safety**

- If the product has a failure, it should not be operated unless it is repaired by the Authorized Service Agent. There is the risk of electric shock!
- Only connect the product to a grounded outlet/line with the voltage and protection as specified in the “Technical specifications”. Have the grounding installation made by a qualified electrician while using the product with or without a transformer. Our company shall not be liable for any problems arising due to the product not being earthed in accordance with the local regulations.
- Never wash the product by spreading or pouring water onto it! There is the risk of electric shock!
- The product must be disconnected during installation, maintenance, cleaning and repairing procedures.
- If the power connection cable for the product is damaged, it must be replaced by the manufacturer, its service agent or similarly qualified persons in order to avoid a hazard.
- Only use the connection cable specified in the “Technical specifications”.

- The appliance must be installed so that it can be completely disconnected from the mains supply. The separation must be provided by a switch built into the fixed electrical installation, according to construction regulations.
- Any work on electrical equipment and systems should only be carried out by authorized and qualified persons.
- In case of any damage, switch off the product and disconnect it from the mains. To do this, turn off the fuse at home.
- Make sure that fuse rating is compatible with the product.
- Do not place any flammable materials close to the product as the sides may become hot during use.
- Keep all ventilation slots clear of obstructions.
- Do not use steam cleaners to clean the appliance as this may cause an electric shock.
- Unattended cooking on a hob with fat or oil can be dangerous and may result in fire. NEVER try to extinguish a fire with water, but switch off the appliance and then cover flame e.g. with a lid or a fire blanket.
- Danger of fire: Do not store items on the cooking surfaces.
- The appliance is not intended to be operated by means of an external timer or separate remote-control system.

### **Product safety**

- The appliance and its accessible parts become hot during use. Care should be taken to avoid touching heating elements. Children less than 8 years of age shall be kept away unless continuously supervised.
- Never use the product when your judgment or coordination is impaired by the use of alcohol and/or drugs.
- Be careful when using alcoholic drinks in your dishes. Alcohol evaporates at high temperatures and may cause fire since it can ignite when it comes into contact with hot surfaces.
- Use only hob guards designed by the manufacturer of the cooking appliance or indicated by the manufacturer of the appliance in the instructions for use as suitable or hob guards incorporated in the appliance. The use of inappropriate guards can cause accidents.
- Prevention against possible fire risk!
- Ensure all electrical connections are secure and tight to prevent risk of arcing.
- Do not use damaged cables or extension cables.
- Ensure liquid or moisture is not accessible to the electrical connection point.

**Intended use**

- This product is designed for domestic use. Commercial use will void the guarantee.
- This appliance is for cooking purposes only. It must not be used for other purposes, for example room heating.
- The manufacturer shall not be liable for any damage caused by improper use or handling errors.

**Safety for children**

- Accessible parts may become hot during use. Young children should be kept away.
- The packaging materials will be dangerous for children. Keep the packaging materials away from children. Please dispose of all parts of the packaging according to environmental standards.
- Electrical products are dangerous to children. Keep children away from the product when it is operating and do not allow them to play with the product.
- Do not place any items above the appliance that children may reach for.

	<p>Danger of fire: Do not store items on the cooking surface.</p> <p><b>CAUTION:</b> The cooking process has to be supervised. A short term cooking process has to be supervised continuously.</p> <p><b>WARNING:</b> Unattended cooking on a hob with fat or oil can be dangerous and may result in a fire.</p>
--	--

**SAVE THESE INSTRUCTIONS**

### 3 Installation



---

The hob must be installed by a qualified person in accordance with the regulations in force.

Installation is the buyer's responsibility.

The manufacturer accepts no liability for this service.

Any action that the manufacturer has to take as a result of an erroneous installation will not be covered by the warranty.

	Preparation of location and electrical and gas installation for the appliance is the customer's responsibility.
	<b>DANGER</b> The product must be installed in accordance with all local gas and/or electrical regulations.
	<b>DANGER</b> Prior to installation, visually check if the product has any defects on it. If so, do not have it installed. Damaged products cause risks for your safety.

#### Before installation

The hob is designed for installation in a commercial worktop. A safety distance must be left between the appliance and the kitchen walls and furniture. See figure overleaf (values in mm).

It can also be used in a free standing position. Allow a minimum distance of 750 mm above the hob surface.

(\* ) If a cooker hood is to be installed above the cooker, refer to cooker hood manufacturer' instructions regarding installation height (min 650 mm)

Remove packaging materials and transport locks.

Surfaces, synthetic laminates and adhesives used must be heat resistant (100 °C minimum).

The worktop must be aligned and fixed horizontally.

Cut aperture for the hob in worktop as per installation dimensions.

#### Cupboard design

Cooking appliances generate considerable heat. The layout and materials of the mounting cabinet should take account of these characteristics.

Surfaces and surrounding edges immediately adjacent to the hob should be able to withstand temperatures of up to 100° C without delaminating or discolouring.

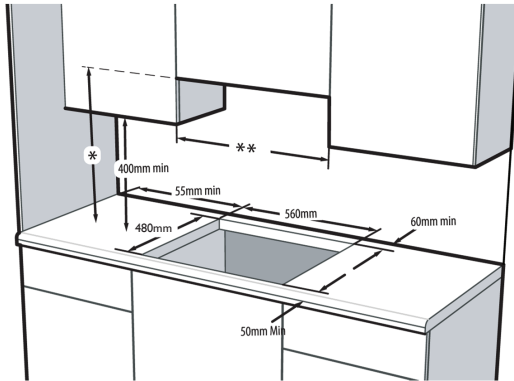

**Installation and connection**

The product must be installed in accordance with all local gas and electrical regulations.

**Electrical connection**

Connect the hob to a grounded outlet/line protected by a fuse of suitable capacity as stated in the "Technical specifications" table.



Have the grounding installation made by a qualified electrician while using the hob with or without a transformer. Our company shall not be liable for any damages that arise due to using the hob without a grounding installation in accordance with the national regulations.

	<p><b>DANGER:</b> Before starting any work on the electrical installation, disconnect the product from the mains supply. There is the risk of electric shock.</p>
---	---

The connection must comply with national regulations.

**The mains supply data must correspond to the data specified on the type label of the hob.**

The power cable of your hob must comply with the values in "Technical specifications" table.

	<p><b>DANGER:</b> The product must be connected to the mains supply only by an authorised and qualified person. The product's warranty period starts only after correct installation. Manufacturer shall not be held responsible for damages arising from procedures carried out by unauthorised persons.</p>
	<p><b>DANGER:</b> The power cable must not be clamped, bent or trapped or come into contact with hot parts of the product. A damaged power cable must be replaced by a qualified electrician. Otherwise, there is risk of electric shock, short circuit or fire!</p>

**Connecting the power cable**

1. If a power cable is not supplied together with your product, a power cable that you would select from the table in accordance with the electrical installation at your home must be connected to your product by following the instructions in cable diagram. This product must only be connected by a qualified electrician such as a technician from the local electricity company to a suitable double-pole control unit with a minimum contact clearance of 3 mm in all poles. Failure to obey this instruction may cause operational problems and invalidate the product warranty.



Additional protection by a residual current circuit breaker is recommended.

2. Open the terminal block cover with a screwdriver.
3. Insert the power cable through the cable clamp below the terminal and secure it to the main body with the integrated screw on cable clamping component.
4. Connect the cables according to the supplied diagram.

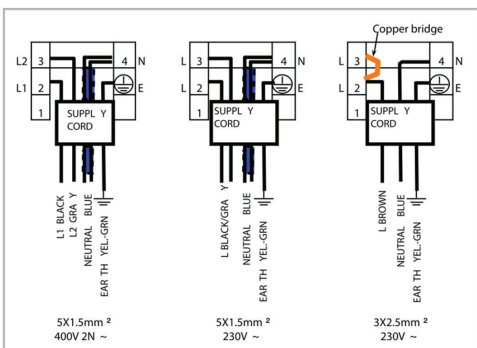

5. After completing the wire connections, close the terminal block cover.
6. Route the power cable so that it will not contact the product and get squeezed between the product and the wall.



The power cable must not be longer than 2m due to safety reasons.

## Installing the product

1. Turning the hob upside down, place it on a flat surface.
2. In order to avoid foreign substances and liquids penetrating between the hob and the counter, please apply the putty supplied in the package to the contours of the lower housing of the hob. Ensure that the putty does not overlap.

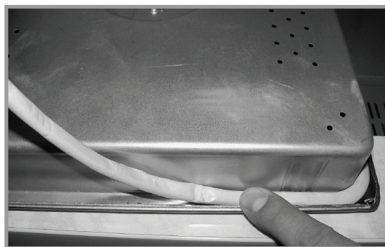

3. Turning the hob correct side up again, align and place it on the counter.
4. You can secure your hob to the counter by using the clamp and the screws supplied.

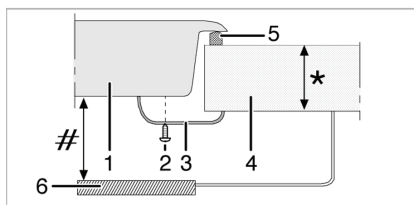

- \* min. 20 & max. 40 mm
- # min. 50 mm
- 1 Hob
- 2 Screw
- 3 Installation clamp
- 4 Counter
- 5 Putty
- 6 Separator plate

If it is possible to touch the bottom of the product if it is installed onto a drawer, then this section must be covered with a wooden plate.

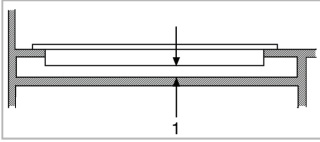

**1 Minimum of 30 mm**



When installing the hob onto a cabinet, a shelf must be installed in order to separate the cabinet from the hob as illustrated in the above figure. This is not required when installing onto a built-in oven.

**Rear view (connection holes)**

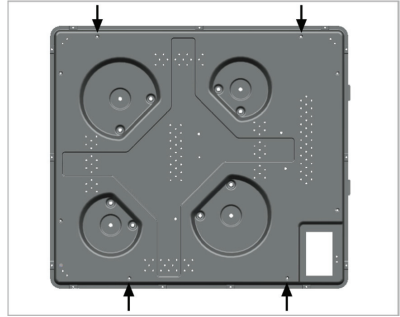

Making connections to different holes is not a good practice in terms of safety since it can damage the gas and electrical system.

**If the oven is below:**

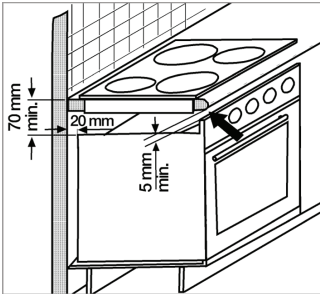

**Final check**

1. Connect the power cable and switch on the product's fuse.
2. Check the functions.

**Package information**

Packaging materials are dangerous to children. Keep packaging materials in a safe place out of reach of children. Packaging materials of the hob are manufactured from recyclable materials in accordance with Environmental Regulations.

Do not dispose of the packaging materials together with domestic or other wastes. Take them to collection points designated by the local authorities.

**Future Transportation**

Keep the hob's original carton and transport the product in it. Follow the instructions on the carton. If you do not have the original carton, pack the product in bubble wrap or thick cardboard and tape it securely.

	Check the general appearance of your product for any damages that might have occurred during transportation.
---	--

**Disposing of an old hob**

Before disposing of the hob, cut off the power cable plug and make the door lock (if any) unusable to avoid dangerous conditions to children.

Do not dispose of the hob with normal domestic waste at the end of its service life. Please consult your local authorities.

## 4 Preparation

---

### Tips for energy saving

**The following information will help you to use your appliance in an ecological way, and to save energy:**

- Defrost frozen dishes before cooking them.
- Use pots/pans with cover for cooking. If there is no cover, energy consumption may increase 4 times.
- Select the burner which is suitable for the bottom size of the pot to be used. Always select the correct pot size for your dishes. Larger pots require more energy.
- Pay attention to use flat bottom pots when cooking with electric hobs.
- Pots with thick bottom will provide a better heat conduction. You can obtain energy savings up to 1/3.
- Vessels and pots must be compatible with the hotplates. Bottom of the vessels or pots must not be smaller than the hotplate.
- Keep the hotplates and bottom of the pots clean. Dirt will decrease the heat conduction between the hotplate and bottom of the pot.
- For long cooking processes, turn off the hotplate 5 or 10 minutes before the end of cooking time. You can obtain energy savings up to 20% by using the residual heat.

### Initial use



The surface might get damaged by some detergents or cleaning materials.

Do not use aggressive detergents, cleaning powders/creams or any sharp objects during cleaning.

Do not use harsh abrasive cleaners or sharp metal scrapers to clean with.

### First cleaning of the appliance

1. Remove all packaging materials.
2. Wipe the surfaces of the hob with a damp cloth or sponge and dry with a cloth.

**Since the following are not factory faults, they are the owner's responsibility.**

- Damage to exterior finish.
- Breakage of glass and other components.
- Damage through improper use or installation of the appliance.
- Damage caused by moving the appliance.

## 5 How to use the hob

### General information about cooking

	<p><b>DANGER Risk of fire by overheated oil!</b> When you heat oil, do not leave it unattended.</p> <p><b>Never try to extinguish the fire with water!</b> When oil has caught fire, immediately cover the pot or pan with a lid. Switch off the hob if safe to do so and phone the fire service.</p>

- Before frying foods, always dry them well and gently place into the hot oil. Ensure complete thawing of frozen foods before frying.
- Do not cover the vessel you use when heating oil.
- Place the pans and saucepans in a manner so that their handles are not over the hob to prevent heating of the handles. Do not place unbalanced and easily tilting vessels on the hob.
- Do not place empty vessels and saucepans on cooking zones that are switched on. They might get damaged.
- Operating a cooking zone without a vessel or saucepan on it will cause damage to the product. Turn off the cooking zones after the cooking is complete.
- As the surface of the product can be hot, do not put plastic and aluminum vessels on it.
- Such vessels should not be used to keep foods either.
- Use flat bottomed saucepans or vessels only.
- Put appropriate amount of food in saucepans and pans. Thus, you will not have to make any unnecessary cleaning by preventing the dishes from overflowing.
- Do not put covers of saucepans or pans on cooking zones.
- Place the saucepans in a manner so that they are centered on the cooking zone. When you want to move the saucepan onto another cooking zone, lift and place it onto the cooking zone you want instead of sliding it.

### Using the hob

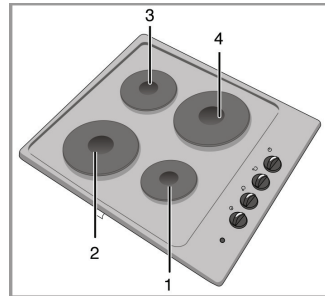

\* List of advised diameter of pots to be used on related burners.

1 Hotplate 14-16 cm

2 Hotplate 18-20 cm

3 Hotplate 14-16 cm

4 Hotplate 18-20 cm

#### Using hotplates

Hob knobs can be turned in both directions and this provides temperature control in steps.

	<p>If the hob is equipped with hotplates featuring Booster function, relevant hotplate will be marked with a red dot. Note: Depends on model.</p>
--	---

#### Switching on the hotplates

Use hotplate knobs to operate the hotplates. Move the hotplate knobs to the relevant level in order to obtain the desired cooking level.

Cooking level	1	2 — 3	4 — 6
	warming	stewing, simmering	boiling

#### Switching off the hotplates

Turn the hotplate knob to OFF (upper) position.

## 6 Maintenance and care

### General information

Service life of the product will extend and the possibility of problems will decrease if the product is cleaned at regular intervals.

	<b>DANGER</b> <b>Risk of electric shock!</b> Switch off the electricity before cleaning product to avoid an electric shock.
	<b>DANGER</b> Hot surfaces may cause burns! Allow the product to cool down before you clean it.

- Clean the product thoroughly after each use. In this way it will be possible to remove cooking residues more easily, thus avoiding these from burning the next time the appliance is used.
- No special cleaning agents are required for cleaning the product. Use warm water with washing liquid, a soft cloth or sponge to clean the product and wipe it with a dry cloth.
- Always ensure any excess liquid is thoroughly wiped off after cleaning and any spillage is immediately wiped dry.
- Do not use cleaning agents that contain acid or chloride to clean the stainless or inox surfaces and the handle. Use a soft cloth with a liquid detergent (not abrasive) to wipe those parts clean, paying attention to sweep in one direction.

	The surface may get damaged by some detergents or cleaning materials. Do not use aggressive detergents, cleaning powder/cream or any sharp objects.
---	--

	Do not use steam cleaners for cleaning as this may cause an electric shock.
---	---

### Cleaning the hob

Electric hobs

1. Turn off the hotplates and wait until they cool down.
2. If necessary, clean the plates with a cleaning agent (you can obtain cleaners/softeners from specialty stores).
3. Warm only for a few minutes after cleaning in order to have their top section dried.
4. Apply a thin layer of machine oil onto the top surface of the hob regularly in order to protect it.

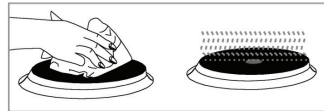

### Cleaning the control panel

Clean the control panel and knobs with a damp cloth and wipe them dry.

	Do not remove the control buttons/knobs to clean the control panel. Control panel may get damaged!
---	--

## Care guide for Slimline Stainless Steel models

CONDITION	ACTION	NOTES AND COMMENTS
Requires routine cleaning.	Mild detergent solution applied with soft sponge or cloth. Rinse and wipe dry.	If possible use warm to hand-hot water. A 5% addition of ammonia is beneficial.
Finger prints.	Pre-treat finger marks with alcohol or an organic solvent. Follow immediately with routine cleaning.	Minimize re-occurrence by applying a wax or silicone based household polish to the clean dry surface.
	Wipe with a little baby oil and a soft lint free cloth. Buff to shine.	Apply whenever necessary.
Stubborn stains and Discolouration.	Use only stainless steel sink cleaner and polish that has been approved by Defy appliances. (Available from Defy Service Departments).	Repeat several times rather than resorting to a single aggressive cleaning method.
Grease and fat splatter.	Wipe off excess with a soft cloth or paper towel. Use a water borne degreasing agent ( dishwashing liquid ).Follow up by routine cleaning.	
Scratches on the brushed finish.	For slight scratches, use a nylon pad loaded with an iron-free abrasive polishing compound. Follow the direction of the original texture. Follow up with routine cleaning. For deep scratches use a coarser abrasive initially and follow up as for light scratches.	Deep scratches will be difficult to remove completely. Do not use steel wool or metal scourers unless they are made from stainless steel.

	<p>SOME OF THE SUGGESTED PROCEDURES WILL ALTER THE SURFACE APPEARANCE OF THE TREATED AREA. THEY SHOULD THEREFORE BE APPLIED WITH DUE CONSIDERATION AND CARE.</p>
---	--

## 7 Troubleshooting

Product emits metal noises while heating and cooling.	
When the metal parts are heated, they may expand and cause noise.	This is not a fault.
Product does not operate.	
The mains fuse is defective or has tripped.	Check fuses in the fuse box. If necessary, replace or reset them.
Product is not plugged into the (grounded) socket.	Check the plug connection.



Contact the customer care line on 086 100 3339 if you can not remedy the trouble although you have implemented the instructions in this section. Never attempt to repair a defective product yourself.



**PLEASE REGISTER YOUR PRODUCT AT**

**[www.defy.co.za](http://www.defy.co.za)**

DEFY APPLIANCES (PTY) LTD

P.O.BOX 12004

JACOBS

DURBAN

4026

SOUTH AFRICA

## 8 Branches

If you have followed the instructions and still have a problem, contact the customer care line on 086 100 3339. They will be able to advise you on any aspect of the appliance.

---

### South African Branches:

#### **BLOEMFONTEIN**

Unit Number 5  
Monument Business Park  
50 Monument Road  
Oranjesig  
Bloemfontein  
[Bloemfontein.Service@defy.co.za](mailto:Bloemfontein.Service@defy.co.za)

#### **CAPE TOWN**

5A Marconi Rd. Montague Gardens, 7441  
[CapeTown.Service@defy.co.za](mailto:CapeTown.Service@defy.co.za)

#### **DURBAN**

135 Teakwood Road, Jacobs,  
Durban, 4052  
[Durban.Service@defy.co.za](mailto:Durban.Service@defy.co.za)

#### **EAST LONDON**

Robbie de Lange Road, Wilsonia,  
East London, 5201  
[EastLondon.Service@defy.co.za](mailto:EastLondon.Service@defy.co.za)

#### **GAUTENG, MIDRAND**

127 15th Road, Cnr Pharmaceutical & 15th Rd,  
Midrand, Gauteng  
[Gauteng.Service@defy.co.za](mailto:Gauteng.Service@defy.co.za)

#### **POLOKWANE**

87 Nelson Mandela Drive, Superbia 0699  
[Polokwane.Service@defy.co.za](mailto:Polokwane.Service@defy.co.za)

#### **PORT ELIZABETH**

112 Patterson Road, North End, Port Elizabeth  
6001  
[PortElizabeth.Service@defy.co.za](mailto:PortElizabeth.Service@defy.co.za)

### Sub-Saharan Africa Branches:

#### **ZAMBIA: SOUTHGATE INVESTMENTS LTD**

Plot 1606, Sheki Sheki Road  
P.O. Box 33681  
Lusaka, 10101, Zambia  
Tel: +260 0211 242332/3  
Fax: +260 0211 242933  
[sgiservicecentre@microlink.zm](mailto:sgiservicecentre@microlink.zm)

#### **NAMIBIA: ATLANTIC DISTRIBUTORS (PTY) LTD**

10 Tienie Louw Street, Northern Industrial Area  
P.O. Box 21158, Windhoek, Namibia  
Tel: (061) 216162  
Fax: (061) 216134  
[atlantic@mweb.com.na](mailto:atlantic@mweb.com.na)

#### **ZIMBABWE: TRADECOMAFRICA**

Trade Com Africa, 183 Loreley Crescent  
Msasa, Harare, Zimbabwe  
Tel: +263 4 486165/6  
Cell: +263 772 469010  
Cell: +263 772 469011

#### **BOTSWANA: RAY MORGAN AGENCIES**

RMA Service Centre, Plot 48, East Gate  
Gaborone International Commerce Park  
Kgale View, Gaborone  
Botswana  
Tel: +267 390 3996 / 390 3912  
Fax: +267 318 7376  
Cell: +267 7134 6539  
[service@rma.co.bw](mailto:service@rma.co.bw); [raja@rma.co.bw](mailto:raja@rma.co.bw)

#### **SWAZILAND: LYNDS DISTRIBUTORS**

P.O Box 716, Mbabane, Swaziland, H100  
Tel: (00268) 2515 4310/8  
Fax: (00268) 2518 4318

#### **MOZAMBIQUE: COOL WORLD. LDA**

Rua da Resistencia No. 97B R/C  
Cell: +258 84 44 61 234  
[coolworldlda@hotmail.com](mailto:coolworldlda@hotmail.com)  
Nosso Show Room  
Av: da Industrias, Parcela No.735 \* 735A  
Machava, Maputo

## 9 Warranty

---

This certificate is issued by DEFY APPLIANCES (PTY) LTD manufacturers of Defy and Ocean products, hereinafter the Company, to the original purchaser only, of the appliance described on the certificate and shall constitute the only warranty given in respect of this appliance.

The Company warrants to the original purchaser that for a period of TWO YEARS from date of purchase the appliance is free from defect under normal domestic use, both in workmanship and material, subject to the following conditions.

1. Repair or replacement of any part of this appliance, found by the Company to be defective, shall be at the election of the Company. The Company reserves the right to effect such service through any of its Service Divisions or Authorised Service Dealers. The cost of such service shall be borne by the Company in full, provided that the appliance is located no further than 50 km from a Company Service Centre or an Authorised Service Dealer. Where the appliance is located beyond the 50 km radius, the purchaser shall be liable for the standard travelling charges, as determined by the Company.

**CARRY IN SERVICE** Microwave ovens, Compact cookers and small appliances are repaired in our service centres and are not collected from the customers home. Faulty units should be delivered to the purchasing dealer or to the nearest Company Service Centre for warranty repairs.

2. Rusted or corroded plates, vitreous enamelware, fuses and lamps are specifically excluded from these warranties. It is an express condition of these warranties that the purchaser takes due care and attention in the use and maintenance of the appliance. Abuse, misuse in conflict with operating instructions, connection to incorrect voltages and subjection to commercial use shall release the Company from its obligations.

3. This warranty shall become void and cease to operate if the appliance is dismantled by, or any repairs to the appliance are effected by any persons not duly authorised by the Company, or if substitute parts not approved by the Company are used in the appliance, or if the serial number of the appliance is removed.

4. The Company shall not be responsible for damages resulting from fire, flood, civil disturbances or any Act of God. The Company shall not, in terms of these warranties be responsible nor held liable for any consequential loss or damage of any kind caused by or due to the failure or malfunction of the appliance. The Company shall not be responsible for damages caused by insect and/or animal infestation.

5. The Company shall not be responsible for transportation or other costs other than those incurred within the provisions of Point 1 of this Certificate.

**6. For warranties in the Republic of South Africa and Sub-Saharan Africa, please contact the customer care line. Please refer to the previous page for respective South African branches and Sub-Saharan Africa branches.**

7. Where service is requested under warranty and no fault or defect can be found by the Company, all costs incurred will be for the purchaser's account.

8. This Certificate as well as your invoice will serve as proof of purchase. For the purpose of warranty, it will be essential to produce this Certificate and invoice. Failure to do so, will render the purchaser liable for service costs.

**KEEP THIS CERTIFICATE AND SALES INVOICE AS PROOF OF PURCHASE FOR WARRANTY PURPOSES.**