

HPE Aruba Networking AP-ANT-313 Antenna for Indoor Access Points



Tri-band omni-directional high-performance dipole antenna (RP-SMA, cabled) for indoor and outdoor use

The AP-ANT-313 antenna is a high-performance, tri-band, omni-directional, indoor/outdoor dipole antenna ideally designed for multifunction access points that require an omnidirectional coverage pattern for WLAN service delivery or air monitoring on the 2.4GHz, 5GHz and/or 6GHz bands.

The AP-ANT-319 ships with all hardware for pole or (suspended) ceiling mounted deployments.

Specifications

Frequency bands, ranges, and peak gains

2.4GHz	2.400GHz–2.500GHz	3dBi
5GHz	4.900GHz–6.000GHz	6dBi
6GHz	6.000GHz–7.125GHz	6dBi

Polarization

Linear, Vertical

Pattern beamwidth (3dB)

2.4GHz Elevation (V): 50 degrees
Azimuth (H): 360 degrees

5GHz Elevation (V): ~20 degrees
Azimuth (H): 360 degrees

6GHz Elevation (V): ~20 degrees
Azimuth (H): 360 degrees

Input impedance

50 Ohms

Maximum input power

2 Watts

VSWR

< 2.0:1

Port isolation

Not applicable—single element antenna

Dimensions

Ø28.6mm x 245.7mm (antenna itself)

362mm x 118mm x 47.6mm (as it ships)

Weight

120g (antenna itself)

565g (as it ships)

Radome

Material: PC ET3113

Color: White

Fly cable length& type/connector

36" Plenum rated RG58LL with RP-SMA connector

Operating temperature range and relative humidity

-40°C to +70°C (temp)
RH 10% - 95% (humidity)

Water and dust protection (IP rating)

Upright position: IP44

Inverted Position: N/A

Wind speed

193 km/hr

Lightning protection

Not applicable

Installation hardware

Inverted ceiling clip for indoor

Inverted I-beam clamp for indoor

Upright pole mount for outdoor

Shipping content

Antenna and mounting hardware included in unit carton

Antenna patterns

Horizontal (azimuth) plane (top view) & Vertical (elevation) planes (front/side view)

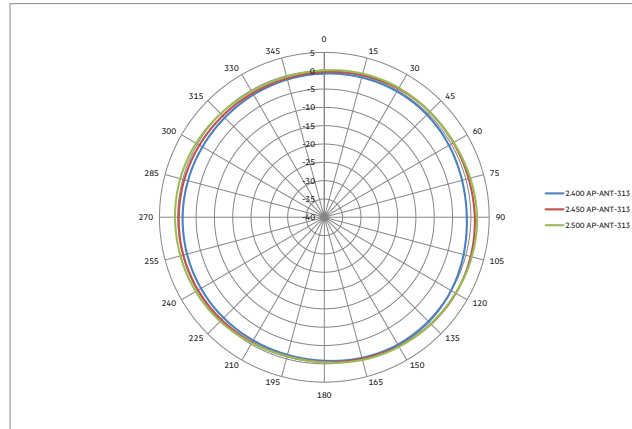

2.4GHz antenna patterns (horizontal)

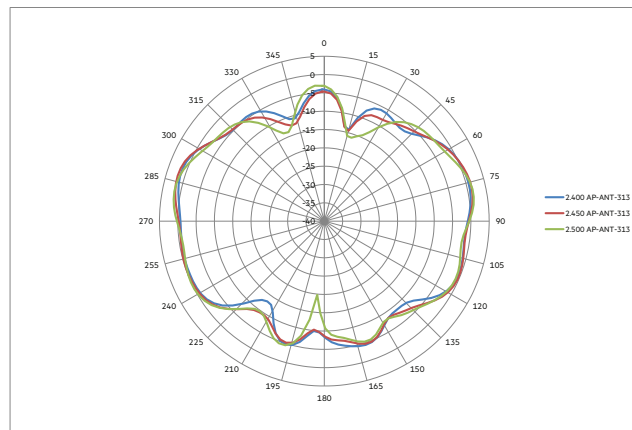

2.4GHz antenna patterns (vertical/0)

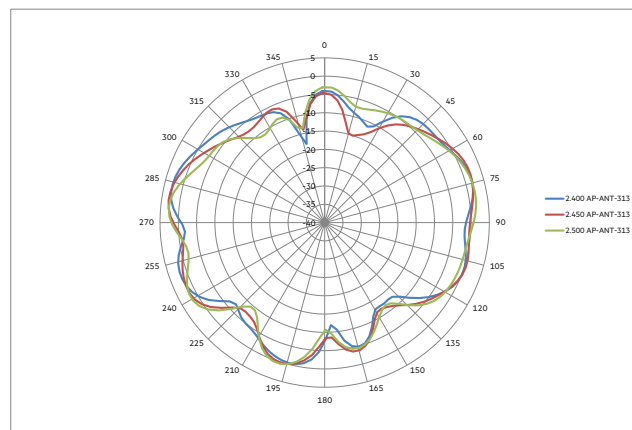

2.4GHz antenna patterns (vertical/90)



Antenna patterns

Horizontal (azimuth) plane (top view) & Vertical (elevation) planes (front/side view)

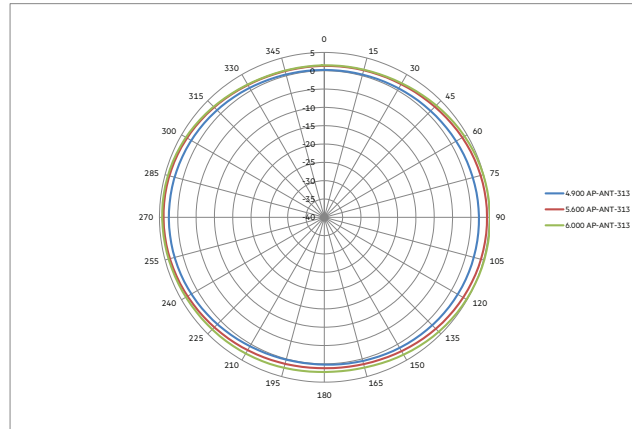

5GHz antenna patterns (horizontal)

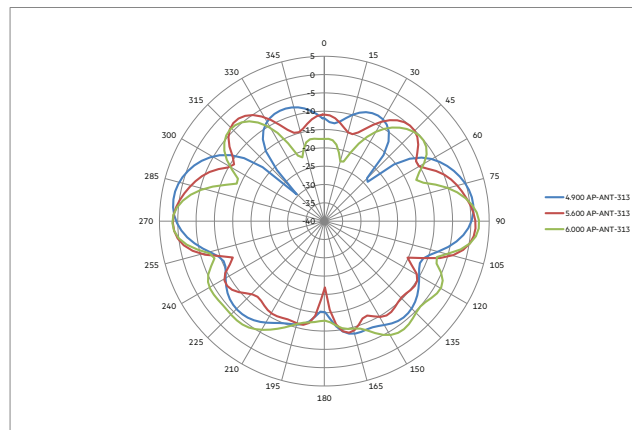

5GHz antenna patterns (vertical/0)

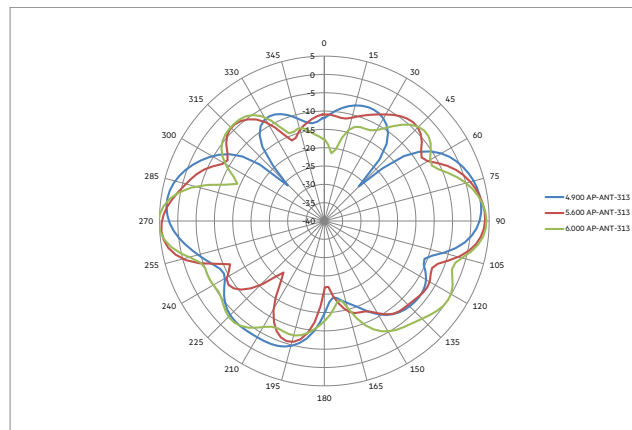

5GHz antennas patterns (vertical/90)



Antenna patterns

Horizontal (azimuth) plane (top view) & Vertical (elevation) planes (front/side view)

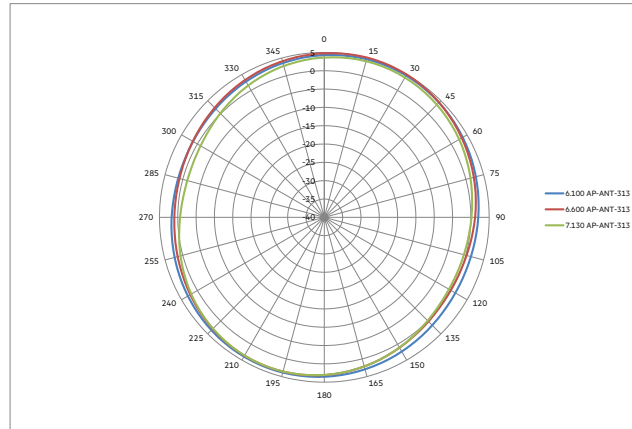

6GHz antenna patterns (horizontal)

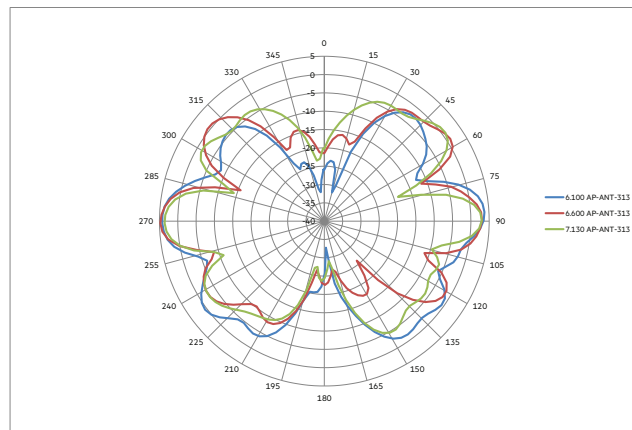

6GHz antenna patterns (vertical/0)

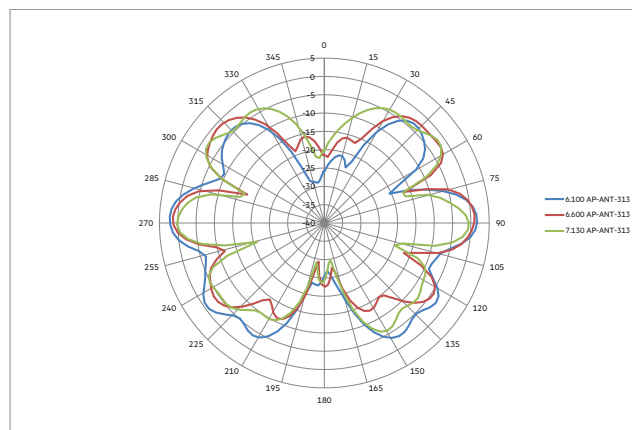

6GHz antenna patterns (vertical-90)



Mechanical drawings

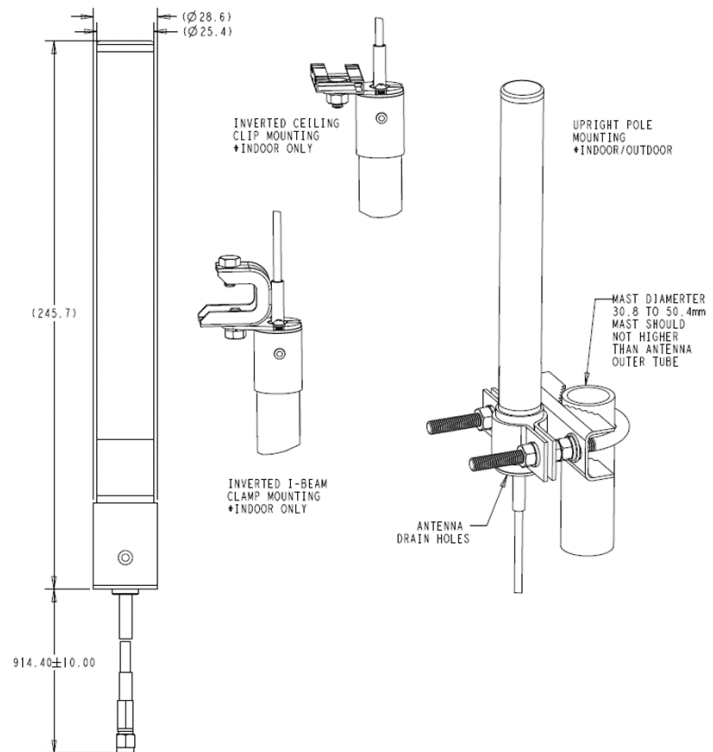

Ordering information

Part number	Description
HPE Aruba Networking Antennas for Indoor Access Points (RP-SMA)	
S1F81A	HPE Aruba Networking AP-ANT-313 Cabled RP-SMA Tri-Band 1x1 Omni Dipole Antenna

Visit [HPE.com](https://www.hpe.com)

 **Chat now (sales)**