

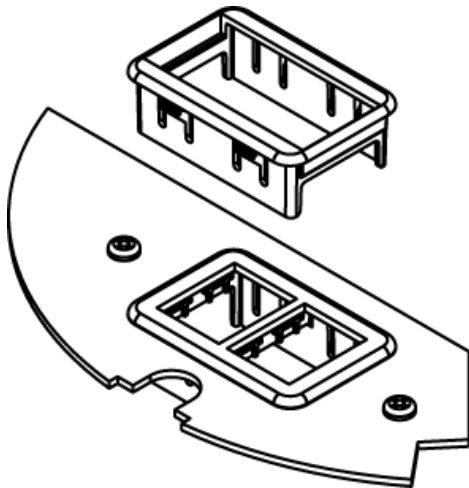

Wiremold
CRFB Series Communication Device Plate
Part No. CRFB-RT-2



The CRFB4 has four compartments that accept different device plates. This Communication Device Plate is for Plate location 2, accepts two (2) ports of communication devices. Includes one (1) Ortronics Series II and one (1) Tracjack adapter. NOTE: Standard size for device plates for Plate Location 2 is 5 7/32" (132mm) x 2 3/4" (62mm).

Features & Benefits

The CRFB4 has four compartments that accept different device plates. This Communication Device Plate is for Plate location 2, accepts two (2) ports of communication devices. Includes one (1) Ortronics Series II and one (1) Tracjack adapter. NOTE: Standard size for device plates for Plate Location 2 is 5 7/32" (132mm) x 2 3/4" (62mm).

Specifications

General Info

Product Line	Wiremold	UPC Number	786564076971
Country Of Origin	United States	Construction	Assembled
Application Sector	Commercial	Standard	UL Listed Classified Raised Floor Box: File E2961 Guide QCIT, UL Listed Classified Raised Floor Box (prewired): File E51105 Guide QQVX Meets Article 314 of NEC. Meets Article 12-2500 of CEC.
Type	Floor Box		

Listing Agencies / 3rd Party Agencies

cULus ListingNumber	E2961	cULus Listed	Yes
---------------------	-------	--------------	-----

Additional Information

RoHS Conformant	Yes
-----------------	-----