



# Video Wall Controller

Quick Start Guide

# Legal Information

## About this Document

- This Document includes instructions for using and managing the Product. Pictures, charts, images and all other information hereinafter are for description and explanation only.
- The information contained in the Document is subject to change, without notice, due to firmware updates or other reasons. Please find the latest version of the Document at the Hikvision website (<https://www.hikvision.com>). Unless otherwise agreed, Hangzhou Hikvision Digital Technology Co., Ltd. or its affiliates (hereinafter referred to as "Hikvision") makes no warranties, express or implied.
- Please use the Document with the guidance and assistance of professionals trained in supporting the Product.

## About this Product

This product can only enjoy the after-sales service support in the country or region where the purchase is made.

## Acknowledgment of Intellectual Property Rights

- Hikvision owns the copyrights and/or patents related to the technology embodied in the Products described in this Document, which may include licenses obtained from third parties.
- Any part of the Document, including text, pictures, graphics, etc., belongs to Hikvision. No part of this Document may be excerpted, copied, translated, or modified in whole or in part by any means without written permission.
- **HIKVISION** and other Hikvision's trademarks and logos are the properties of Hikvision in various jurisdictions.
- Other trademarks and logos mentioned are the properties of their respective owners.
- **HDMI**<sup>™</sup> The terms HDMI and HDMI High-Definition Multimedia Interface, and the HDMI Logo are trademarks or registered trademarks of HDMI Licensing Administrator, Inc. in the United States and other countries.

## LEGAL DISCLAIMER

- TO THE MAXIMUM EXTENT PERMITTED BY APPLICABLE LAW, THIS DOCUMENT AND THE PRODUCT DESCRIBED, WITH ITS HARDWARE, SOFTWARE AND FIRMWARE, ARE PROVIDED "AS IS" AND "WITH ALL FAULTS AND ERRORS". HIKVISION MAKES NO WARRANTIES, EXPRESS OR IMPLIED, INCLUDING WITHOUT LIMITATION, MERCHANTABILITY, SATISFACTORY QUALITY, OR FITNESS FOR A PARTICULAR PURPOSE. THE USE OF THE PRODUCT BY YOU IS AT YOUR OWN RISK. IN NO EVENT WILL HIKVISION BE LIABLE TO YOU FOR ANY SPECIAL, CONSEQUENTIAL, INCIDENTAL, OR INDIRECT DAMAGES, INCLUDING, AMONG OTHERS, DAMAGES FOR LOSS OF BUSINESS PROFITS, BUSINESS INTERRUPTION, OR LOSS OF DATA, CORRUPTION OF SYSTEMS, OR LOSS OF DOCUMENTATION, WHETHER BASED ON BREACH OF CONTRACT, TORT (INCLUDING NEGLIGENCE), PRODUCT LIABILITY, OR OTHERWISE, IN CONNECTION WITH THE USE OF THE PRODUCT, EVEN IF HIKVISION HAS BEEN ADVISED OF THE POSSIBILITY OF SUCH DAMAGES OR LOSS.
- YOU ACKNOWLEDGE THAT THE NATURE OF THE INTERNET PROVIDES FOR INHERENT SECURITY RISKS, AND

HIKVISION SHALL NOT TAKE ANY RESPONSIBILITIES FOR ABNORMAL OPERATION, PRIVACY LEAKAGE OR OTHER DAMAGES RESULTING FROM CYBER-ATTACK, HACKER ATTACK, VIRUS INFECTION, OR OTHER INTERNET SECURITY RISKS; HOWEVER, HIKVISION WILL PROVIDE TIMELY TECHNICAL SUPPORT IF REQUIRED.

- YOU AGREE TO USE THIS PRODUCT IN COMPLIANCE WITH ALL APPLICABLE LAWS, AND YOU ARE SOLELY RESPONSIBLE FOR ENSURING THAT YOUR USE CONFORMS TO THE APPLICABLE LAW. ESPECIALLY, YOU ARE RESPONSIBLE, FOR USING THIS PRODUCT IN A MANNER THAT DOES NOT INFRINGE ON THE RIGHTS OF THIRD PARTIES, INCLUDING WITHOUT LIMITATION, RIGHTS OF PUBLICITY, INTELLECTUAL PROPERTY RIGHTS, OR DATA PROTECTION AND OTHER PRIVACY RIGHTS. YOU SHALL NOT USE THIS PRODUCT FOR ANY PROHIBITED END-USES, INCLUDING THE DEVELOPMENT OR PRODUCTION OF WEAPONS OF MASS DESTRUCTION, THE DEVELOPMENT OR PRODUCTION OF CHEMICAL OR BIOLOGICAL WEAPONS, ANY ACTIVITIES IN THE CONTEXT RELATED TO ANY NUCLEAR EXPLOSIVE OR UNSAFE NUCLEAR FUEL-CYCLE, OR IN SUPPORT OF HUMAN RIGHTS ABUSES.
- IN THE EVENT OF ANY CONFLICTS BETWEEN THIS DOCUMENT AND THE APPLICABLE LAW, THE LATTER PREVAILS.

**© Hangzhou Hikvision Digital Technology Co., Ltd. All rights reserved.**

## Preface

### Applicable Models

This manual is applicable to the C30S series video wall controller.

### Default Parameters

Type	Default Parameter
Device	<ul style="list-style-type: none"> <li>• Login user name: admin</li> </ul>
SSH connection	<ul style="list-style-type: none"> <li>• IP address: 192.0.0.64</li> </ul>





To improve system security, it is highly recommended to change password regularly. In order to protect your privacy and corporate data and avoid network security issues, it is recommended to set strong password that meets security requirements.

---

### Symbol Conventions

The symbols that may be found in this document are defined as follows.

Symbol	Description
 <b>Note</b>	Provides additional information to emphasize or supplement important points of the main text.
 <b>Caution</b>	Indicates a potentially hazardous situation, which if not avoided, could result in equipment damage, data loss, performance degradation, or unexpected results.
 <b>Danger</b>	Indicates a hazard with a high level of risk, which if not avoided, will result in death or serious injury.

### Safety Instructions



- The device must be connected to an earthed mains socket-outlet.

- The socket-outlet shall be installed near the device and shall be easily accessible.
- Do not touch the bare components (such as the metal contacts of the inlets) and wait for at least 5 minutes, since electricity may still exist after the device is powered off.
- Never place the device in an unstable location. The device may fall, causing serious personal injury or death.
- This is a class A product and may cause radio interference in which case the user may be required to take adequate measures.
- This device is not suitable for use in locations where children are likely to be present.
- CAUTION: Risk of explosion if the battery is replaced by an incorrect type.
- Improper replacement of the battery with an incorrect type may defeat a safeguard (for example, in the case of some lithium battery types).
- Do not dispose of the battery into fire or a hot oven, or mechanically crush or cut the battery, which may result in an explosion.
- Do not leave the battery in an extremely high temperature surrounding environment, which may result in an explosion or the leakage of flammable liquid or gas.
- Do not subject the battery to extremely low air pressure, which may result in an explosion or the leakage of flammable liquid or gas.
- Dispose of used batteries according to the instructions.
- Keep body parts away from fan blades. Disconnect the power source during servicing.

 **Note**

- Make sure that the power has been disconnected before you wire, install, or disassemble the device.
- The device shall not be exposed to water dripping or splashing, and no objects filled with liquids, such as vases, shall be placed on the device.
- No naked flame sources, such as lighted candles, should be placed on the device.
- If the device needs to be wired by yourself, select the corresponding wire to supply power according to the electric parameters labeled on the device. Strip off wire with a standard wire stripper at corresponding position. To avoid serious consequences, the length of stripped wire shall be appropriate, and conductors shall not be exposed.
- If smoke, odor, or noise arises from the device, immediately turn off the power, unplug the power cable, and contact the service center.
- Install the device according to the instructions in Quick Start Guide.
- To prevent injury, this device must be securely attached to the installation surface in accordance with the installation instructions.
- The device is a system-level monitoring equipment, which is generally placed in the central computer room of the monitoring system at all levels. The selection of the installation site should comply with the relevant standards of the computer room construction in the country and region of use.
- This device is suitable for use in equipment room only.

- Do not place the device in an environment with strong vibration, impact, or strong electromagnetic interference (ignorance can cause equipment damage).
- Do not expose the device to the explosive situation.
- Do not touch the exposed connection points or components when the device is powered on.
- Keep a minimum 25 cm distance around the device for sufficient ventilation.
- The ventilation should not be impeded by covering the ventilation openings with items, such as newspapers, table-cloths, curtains. The openings shall never be blocked by placing the device on a bed, sofa, rug, or other similar surface.

# TABLE OF CONTENTS

<b>Chapter 1 Introduction .....</b>	<b>1</b>
1.1 Overview .....	1
1.2 Packing List.....	1
1.3 Appearance .....	2
1.3.1 Host System .....	2
1.3.2 Service Board .....	4
<b>Chapter 2 Installation .....</b>	<b>11</b>
2.1 Safety Precautions .....	11
2.2 Install a Board .....	12
2.3 Install the Device in the Rack.....	14
2.4 Connect Cables .....	15
2.4.1 Connect the Grounding Cable.....	15
2.4.2 Connect the Network Cable.....	17
2.4.3 Connect the Power Cord.....	18
2.5 Power On the Device .....	18
<b>Chapter 3 Get More Information .....</b>	<b>19</b>

# Chapter 1 Introduction

## 1.1 Overview

As a new-generation FPGA-based hardware image processing device, the DS-C30S series video wall controller (hereinafter referred as the device or the controller) has a new system architecture, adopts dual data exchange technology, and uses main control board plus input board and output board. It supports large-capacity data transmission and processing, multi-channel HD and ultra-HD signal access and real-time processing, and multi-screen management. It is mainly used for large screen splicing control system, and is the core control device of the system.

## 1.2 Packing List

Table 1-1 Packing List

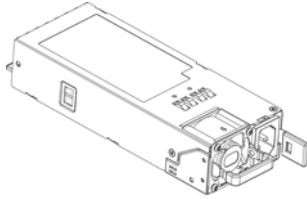
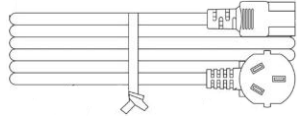
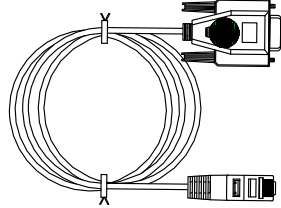
Item	Figure	Quantity	Device
Power supply		3	Chassis
AC power cord		2	
DB-9 to RJ-45 cable		1	

## 1.3 Appearance

### 1.3.1 Host System

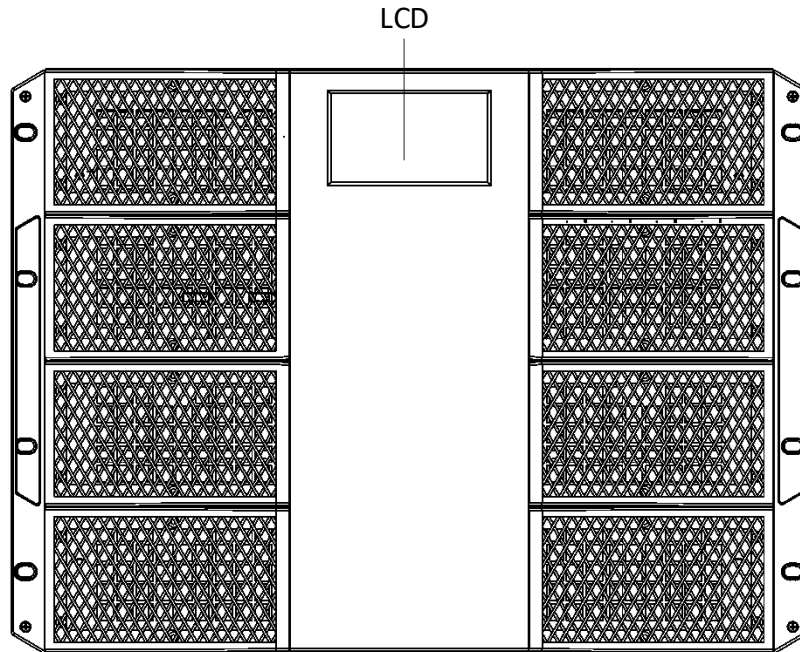

Figure 1-1 Front View of Device

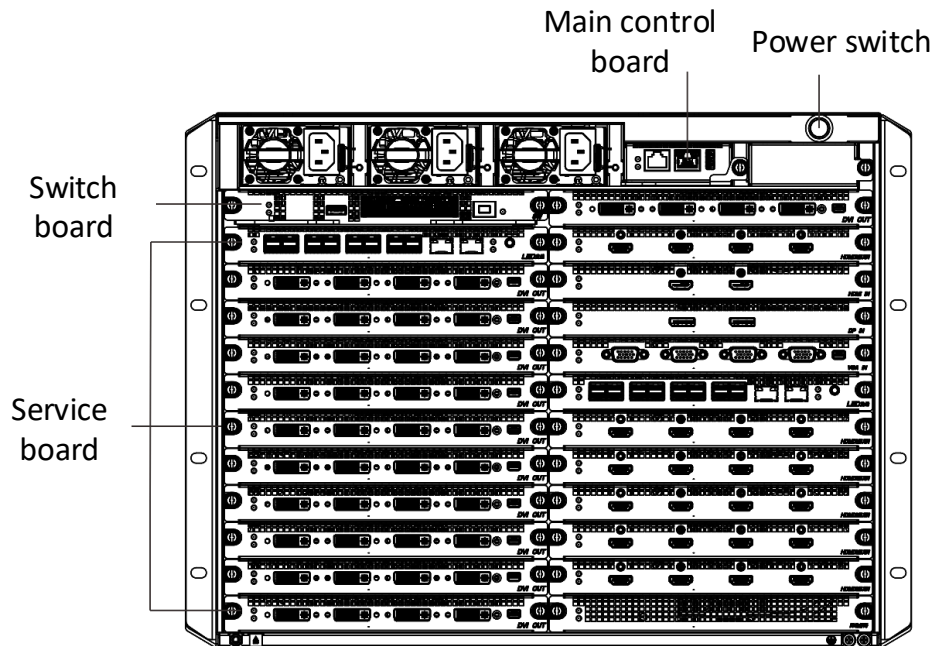

Figure 1-2 Rear View of Device

## Main Control Board

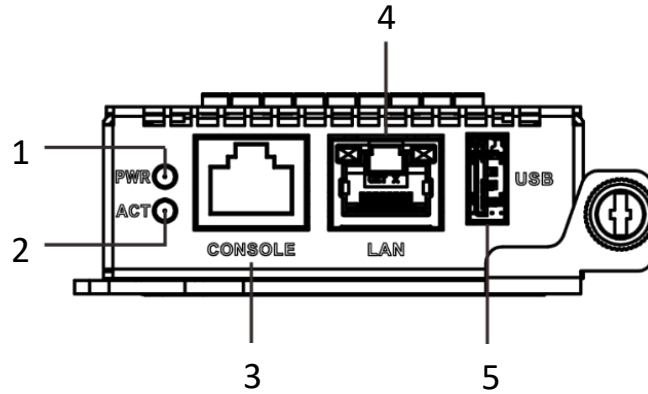

Figure 1-3 Front View of Main Control Board

No.	Name	Description
1	Power LED	When the board is powered on normally, the power LED is steady green.
2	Active LED	When the board runs normally, the active LED is steady green.
3	Console port	Used for device debugging, parameter configuration, etc.
4	Network port	Reserved.
5	USB 2.0 port	Used to connect external devices such as mouse, keyboard, USB flash drive, etc.

## Switch Board

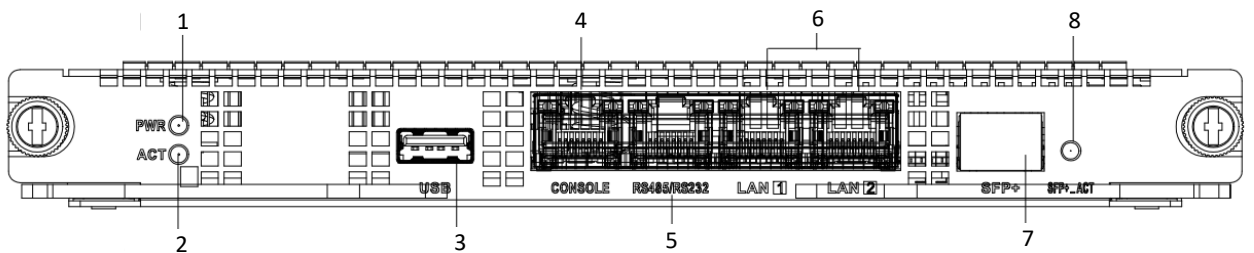

Figure 1-4 Front View of Switch Board

No.	Name	Description
1	Power LED	When the board is powered on normally, the power LED is steady green.
2	Active LED	When the board runs normally, the active LED is flashing green.
3	USB 2.0 port	Reserved, used to connect external devices such as mouse, keyboard, USB flash drive, etc.
4	Console port	Used for device debugging, parameter configuration, etc.
5	RS-485/RS-232 port	RJ-45 port, used for screen control, serial port keyboard control, etc.
6	Network port	Provide 2 network ports for network connection.
7	SFP port	Support one 10 Gigabit optical module.
8	SFP port LED	<ul style="list-style-type: none"> <li>• When the SPF port is inserted with an optical module, the SPF port LED is steady green.</li> <li>• When data transmission is available, the SPF port LED is flashing green.</li> </ul>

### 1.3.2 Service Board

The host system uses different service boards to realize different functions. The service boards are hot swappable.

#### VGA Input Board

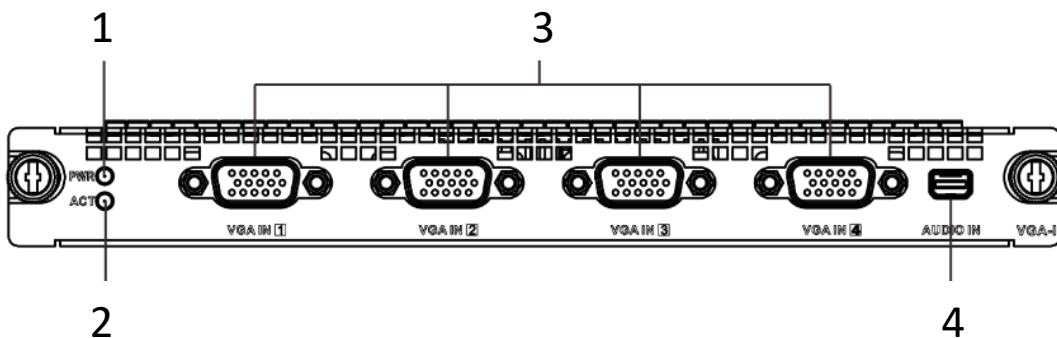

Figure 1-5 Front View of VGA Input Board

No.	Name	Description
1	Power LED	When the board is powered on normally, the power LED is steady green.
2	Active LED	When the board runs normally, the active LED is flashing green.
3	VGA video input port	Provide 4 ports for VGA video input.
4	Audio input port	Provide a mini-DP 4-in-1 line-in audio input port. Use an external audio adapter cable to connect to this port for audio input.

### HDMI UHD Input Board

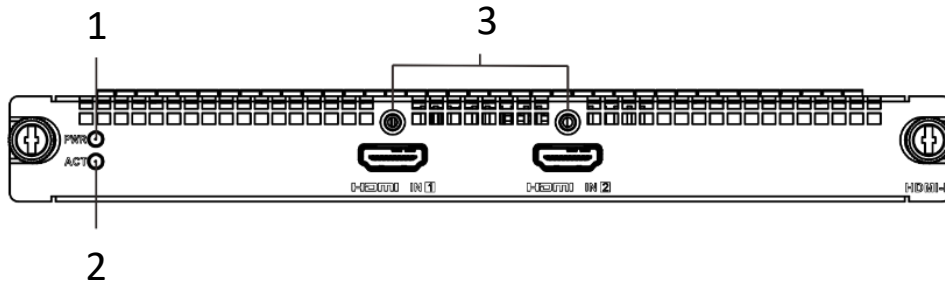

Figure 1-6 Front View of HDMI UHD Input Board

No.	Name	Description
1	Power LED	When the board is powered on normally, the power LED is steady green.
2	Active LED	When the board runs normally, the active LED is flashing green.
3	HDMI video input port	Provide 2 ports for HDMI UHD video input.

### DP Input Board

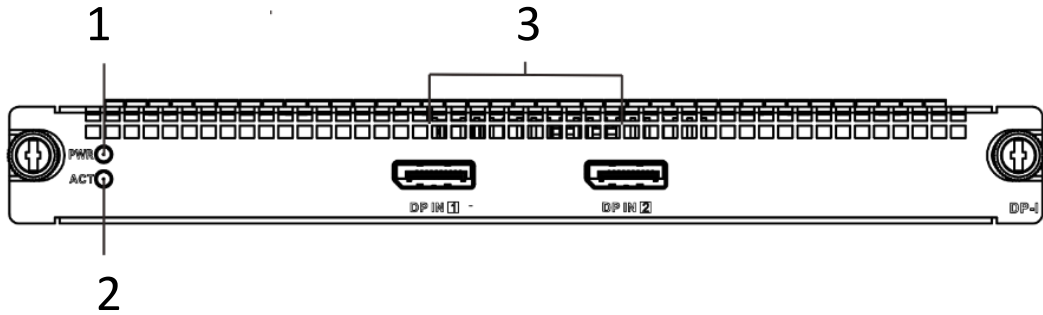

Figure 1-7 Front View of DP Input Board

No.	Name	Description
1	Power LED	When the board is powered on normally, the power LED is steady green.
2	Active LED	When the board runs normally, the active LED is flashing green.
3	DP video input port	Provide 2 ports for DP UHD video input.

**Note**

To connect a 4K@60 Hz video signal source, only one DP video input port can be used.

### DVI Input Board

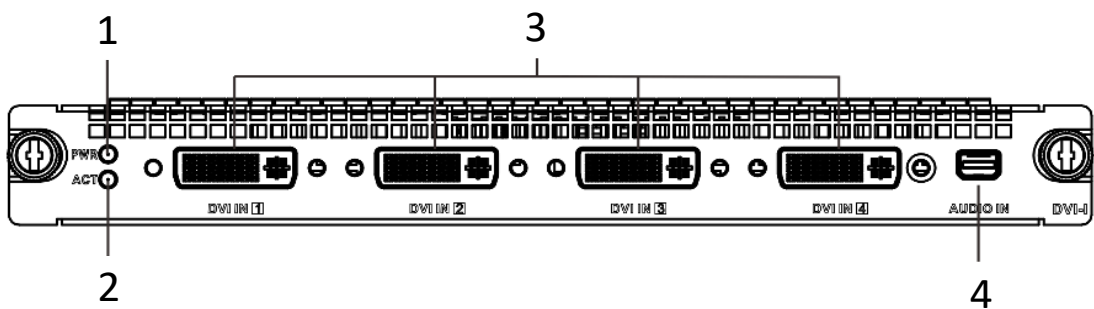

Figure 1-8 Front View of DVI Input Board

No.	Name	Description
1	Power LED	When the board is powered on normally, the power LED is steady green.
2	Active LED	When the board runs normally, the active LED is flashing green.
3	DVI video input port	Provide 4 ports for DVI video input.
4	Audio input port	Provide a mini-DP 4-in-1 line-in audio input port. Use an external audio adapter cable to connect to this port for audio input.

### DVI Output Board

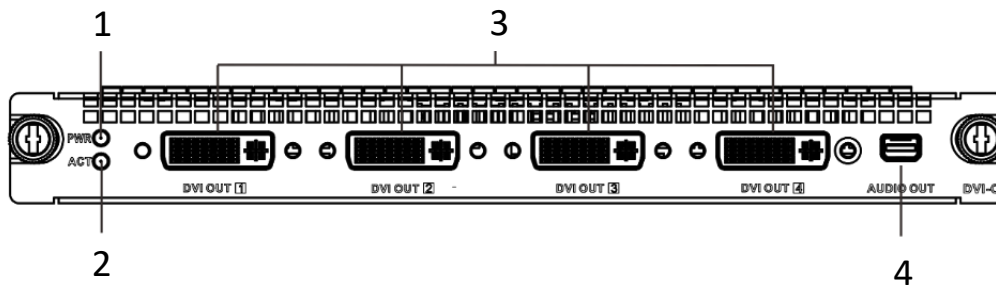

Figure 1-9 Front View of DVI Output Board

No.	Name	Description
1	Power LED	When the board is powered on normally, the power LED is steady green.
2	Active LED	When the board runs normally, the active LED is flashing green.
3	DVI video output port	Provide 4 ports for DVI video output.
4	Audio output port	Provide a mini-DP 4-in-1 line-in audio output port. Use an external audio adapter cable to connect to this port for audio output.

### HDMI Input Board

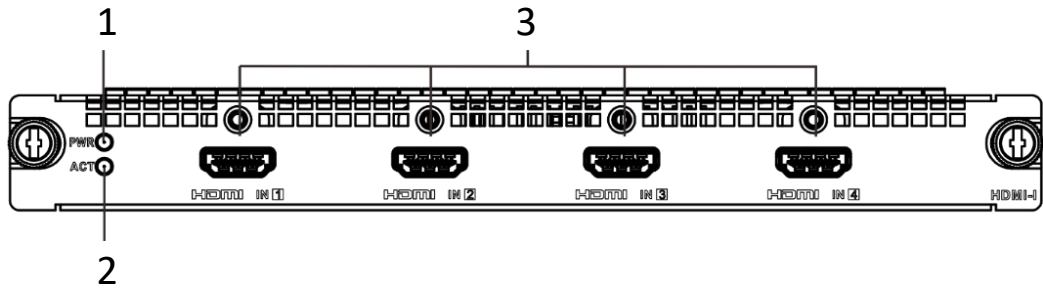

Figure 1-10 Front View of HDMI Input Board

No.	Name	Description
1	Power LED	When the board is powered on normally, the power LED is steady green.
2	Active LED	When the board runs normally, the active LED is flashing green.
3	HDMI video input port	Provide 4 ports for HDMI video input.

### HDMI Output Board

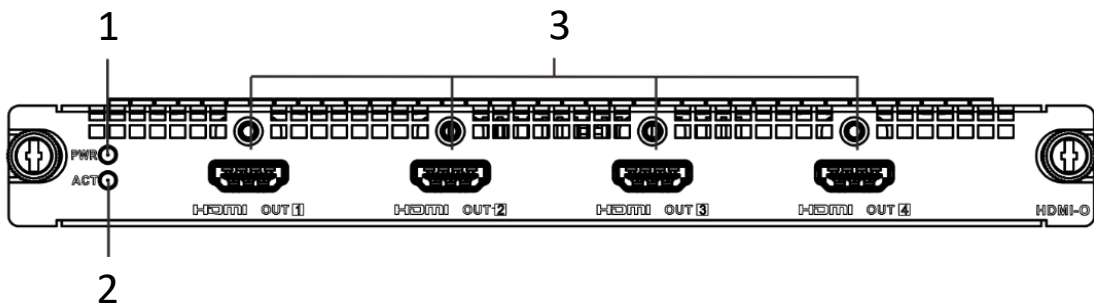

Figure 1-11 Front View of HDMI Output Board

No.	Name	Description
1	Power LED	When the board is powered on normally, the power LED is steady green.
2	Active LED	When the board runs normally, the active LED is flashing green.
3	HDMI video output port	Provide 4 ports for HDMI video output.

### HDMI UHD Output Board

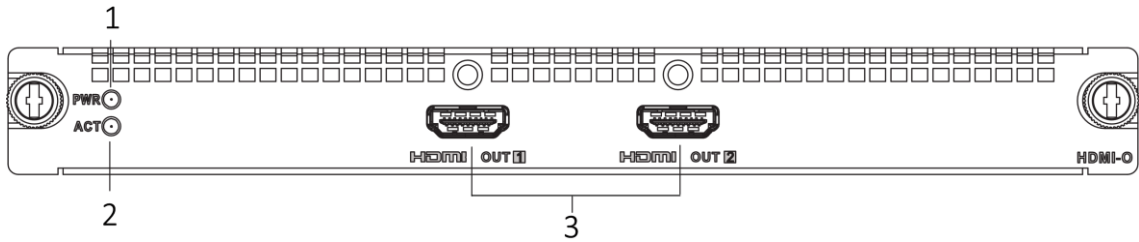

Figure 1-12 Front View of HDMI UHD Output Board

No.	Name	Description
1	Power LED	When the board is powered on normally, the power LED is steady green.
2	Active LED	When the board runs normally, the active LED is flashing green.
3	HDMI video output port	Provide 2 ports for HDMI UHD video output.

### Network Decoding Board

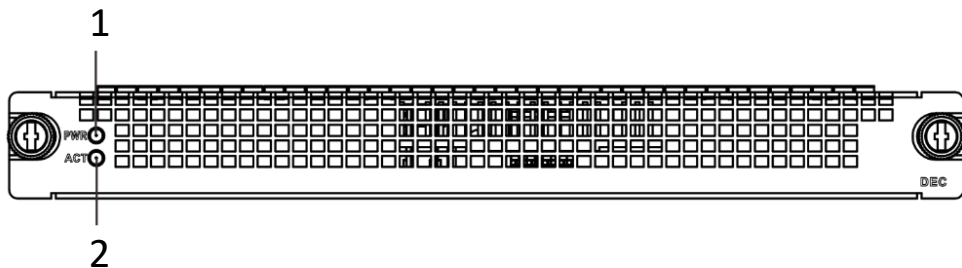

Figure 1-13 Front View of Network Decoding Board

No.	Name	Description
1	Power LED	When the board is powered on normally, the power LED is steady green.
2	Active LED	When the board runs normally, the active LED is flashing green.

## LED Sending Card

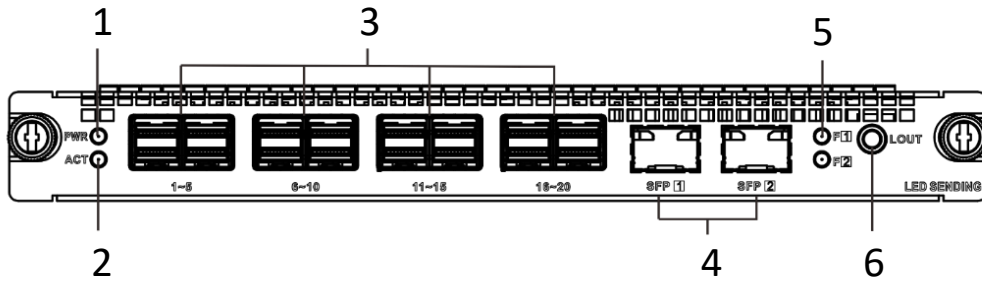

Figure 1-14 Front View of LED Sending Card

No.	Name	Description
1	Power LED	When the board is powered on normally, the power LED is steady green.
2	Active LED	When the board runs normally, the active LED is flashing green.
3	Gigabit network port	Use the mini SAS cable converting one mini SAS HD 8X connector to five RJ-45 female connectors to connect the port.
4	10 Gigabit SFP port	Support two 10 Gigabit optical modules.
5	10 Gigabit SFP port LED	When the inserted 10 Gigabit optical module functions normally, the 10 Gigabit SFP port LED is steady green.
6	Audio output port	Support line-out audio output through left and right channels or two separate channels.

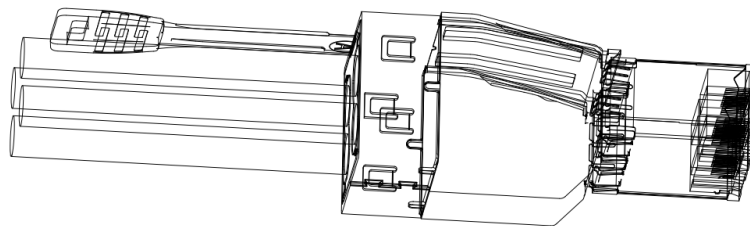

Figure 1-15 Mini SAS cable

## Chapter 2 Installation

### 2.1 Safety Precautions

---



As a high-precision, system-level electronic product, the device should be installed and maintained by professionals.

---

In order to avoid personal and property injury, please read the safety precautions in this section carefully before installation. The following safety recommendations do not cover all possible dangerous situations.

#### Electricity Safety

- During the installation, wiring, disassembly, and maintenance of the device, please disconnect the power supply and do not operate with electricity (except for the operation of the hot plug).
- In the installation and use of the device, make sure to follow the local electrical safety regulations.
- In case of abnormal phenomena such as smoke or odor occur during the use of the device, please cut off the power immediately, unplug the power cord from the socket, and contact the after-sales service center in time.

#### Anti-Static Measures

The equipment is a precision electronic device. In order to avoid static electricity from damaging the components, in addition to anti-static measures in the equipment room, you also need to pay attention to the following measures:

- During the installation process (especially when installing the main control board and service board), you must wear anti-static gloves or anti-static wrists.
- When holding the main control board or the service board, try to avoid touching the components or printed circuits.

#### Grounding Requirements

In order to ensure personal safety and device safety, the device must be grounded.

## Power Supply Requirements

The device supports 100 VAC to 240 VAC@50/60 Hz power supply. To ensure the stable operation of the device, it is recommended to install UPS for power supply.

## Anti-Interference Requirements

- The on-site power supply system must have effective measures to prevent grid interference.
- Do not use the working ground together with the grounding device or lightning protection grounding device of power equipment, and keep the two as far away as possible.
- Keep away from high-power radio transmitters, radar transmitters, and high-frequency and high-current equipment.
- When necessary, electromagnetic shielding can be used for anti-interference.

## Environmental Requirements

The device is a system-level monitoring equipment, which is generally placed in the central equipment room of the monitoring system at all levels. The selection of the installation site should comply with the relevant standards of the equipment room construction in the country and region of use.

The device is a standard rack-mounted equipment. Please pay attention to the following information during installation and use:

- Ensure that the temperature in the rack is from 0 °C to 50 °C.
- Ensure that the humidity in the equipment room is between 10% and 90% RH.
- Ensure that the rack is strong enough to support the weight of the device and its accessories. During the installation, avoid the risk caused by uneven mechanical load.
- Ensure that there is enough installation space for the video and audio cables. The bending radius of a cable should not be less than 5 times the cable outer diameter.
- Keep the horizontal distance between the video wall controller and other devices above 50 cm for sufficient ventilation.

## 2.2 Install a Board

The device uses the plug-in modular design. You can install service boards to realize different functions and use the main control board to manage the functions. The following installs a service board as an example.

Step 1 Remove some or all baffles from the slots of the device as required.

- 1) Use a screwdriver to loosen the screws on both sides of a baffle.
- 2) Pull the baffle out of the slot.

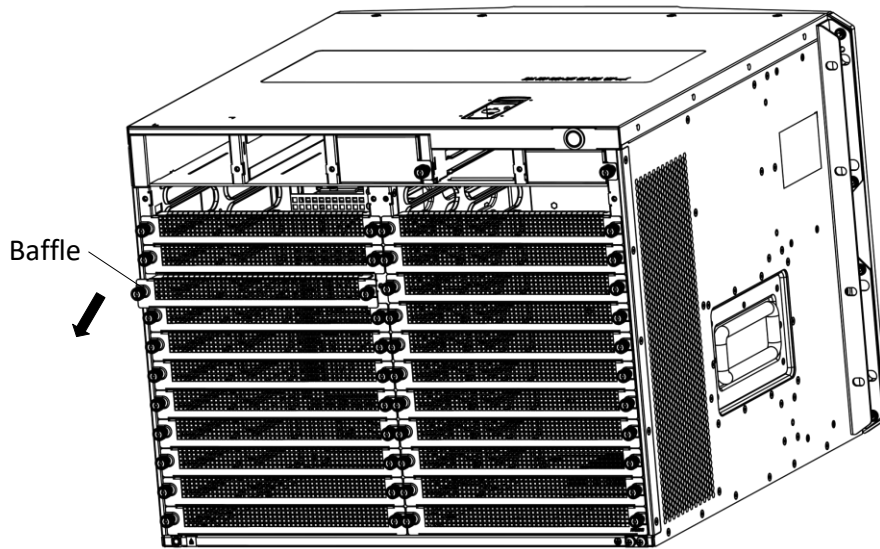

Figure 2-1 Remove the Baffle

**Note**

Do not remove the baffle from the empty slot to avoid affecting the ventilation.

Step 2 Insert a service board into the slot.

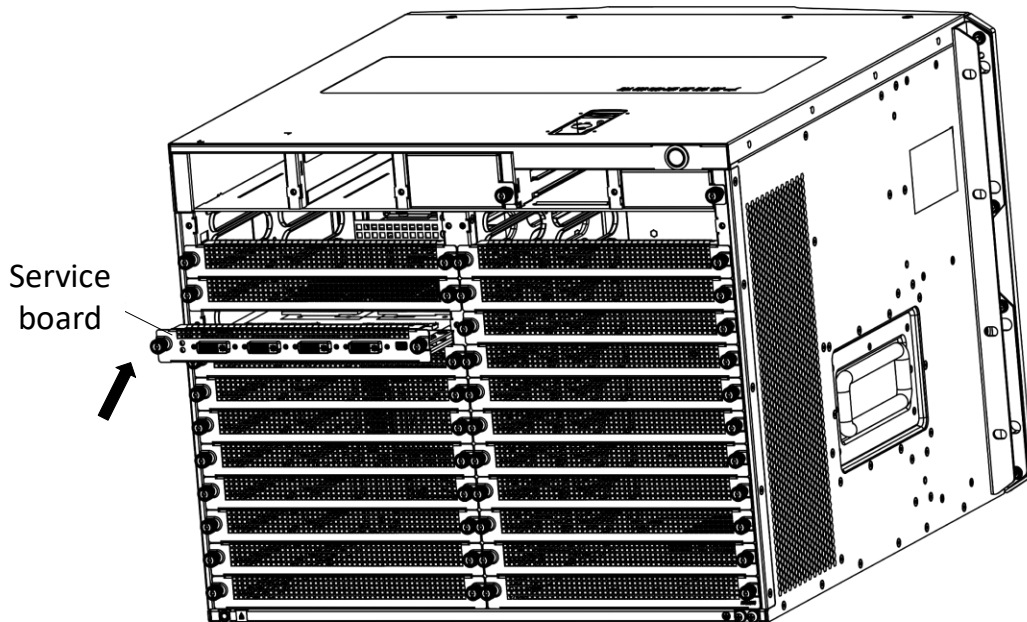

Figure 2-2 Insert a Service Board

Step 3 Push the service board to the bottom.

Step 4 Use a screwdriver to tighten the screws on both sides.

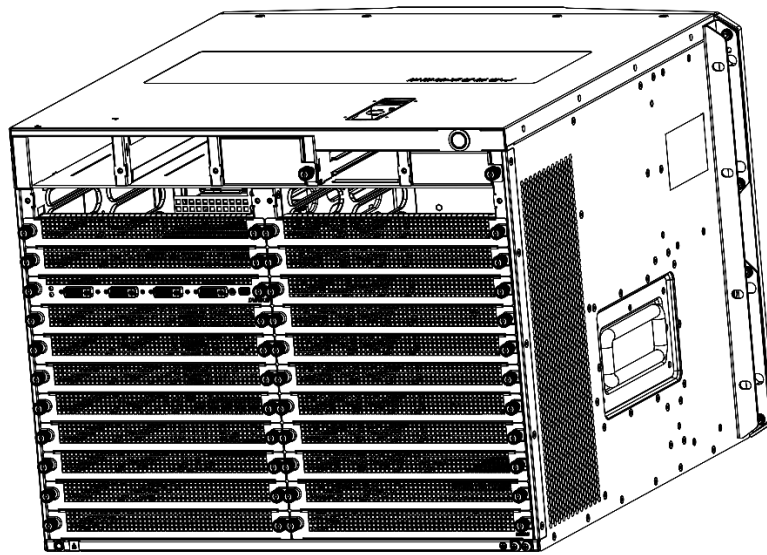

Figure 2-3 Secure the Service Board to the Slot

## 2.3 Install the Device in the Rack

The device is designed according to 8 U standard rack architecture. The front weight and rear weight of the device are inconsistent. Lift the device with cautious.

### Note

Prepare the rack and rack bracket by yourself.

Step 1 Verify that the rack is reliably grounded and is stable.

Step 2 Install a rack bracket on an empty slot of the rack and secure the rack bracket by screws.  
Make sure the rack bracket can support the device.

Step 3 Place the 8 U device on the bracket and use the fixed screws to secure the mounting brackets to the fixing grooves on both sides of the rack.

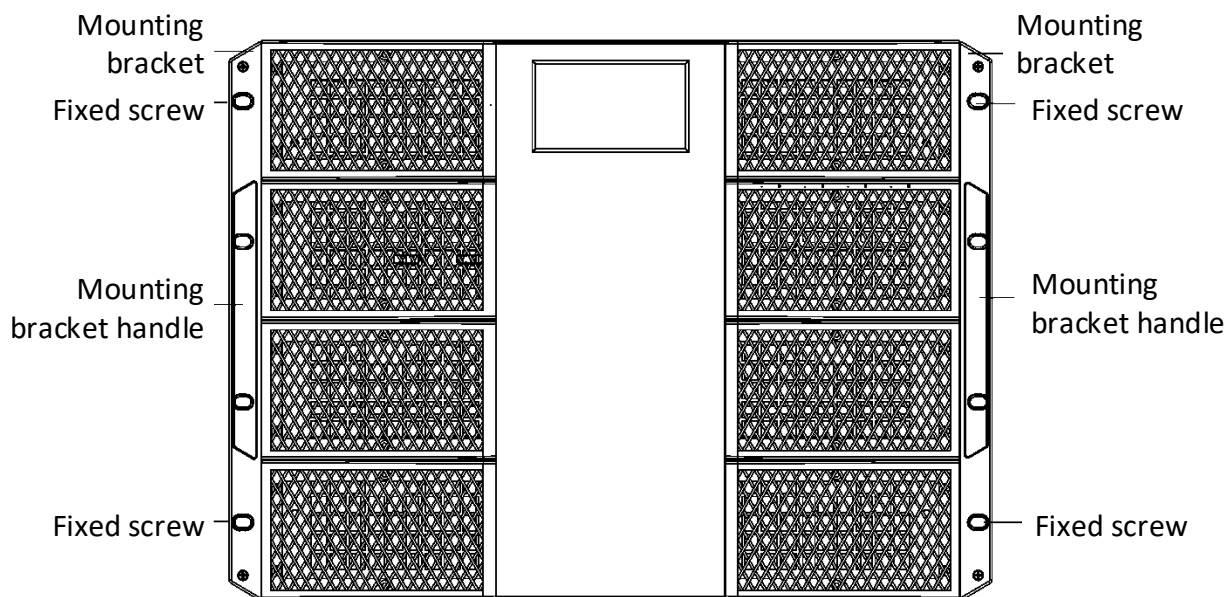

Figure 2-4 Rack Mount the 8 U Device

## 2.4 Connect Cables

### 2.4.1 Connect the Grounding Cable

Connecting the grounding cable can release the excessive voltage and current induced by lightning shock. Please select the most suitable connection mode to protect the grounding cable according to the installation environment.



**Danger**

The device must be grounded to ensure the personal safety and device safety.

#### **With Grounding Row**

Step 1 Connect one end of the grounding cable (2) to the grounding terminal of the grounding row (3) in the equipment room.

Step 2 Connect the other end of the grounding cable to a grounding terminal (1) of the device and tighten the screw.

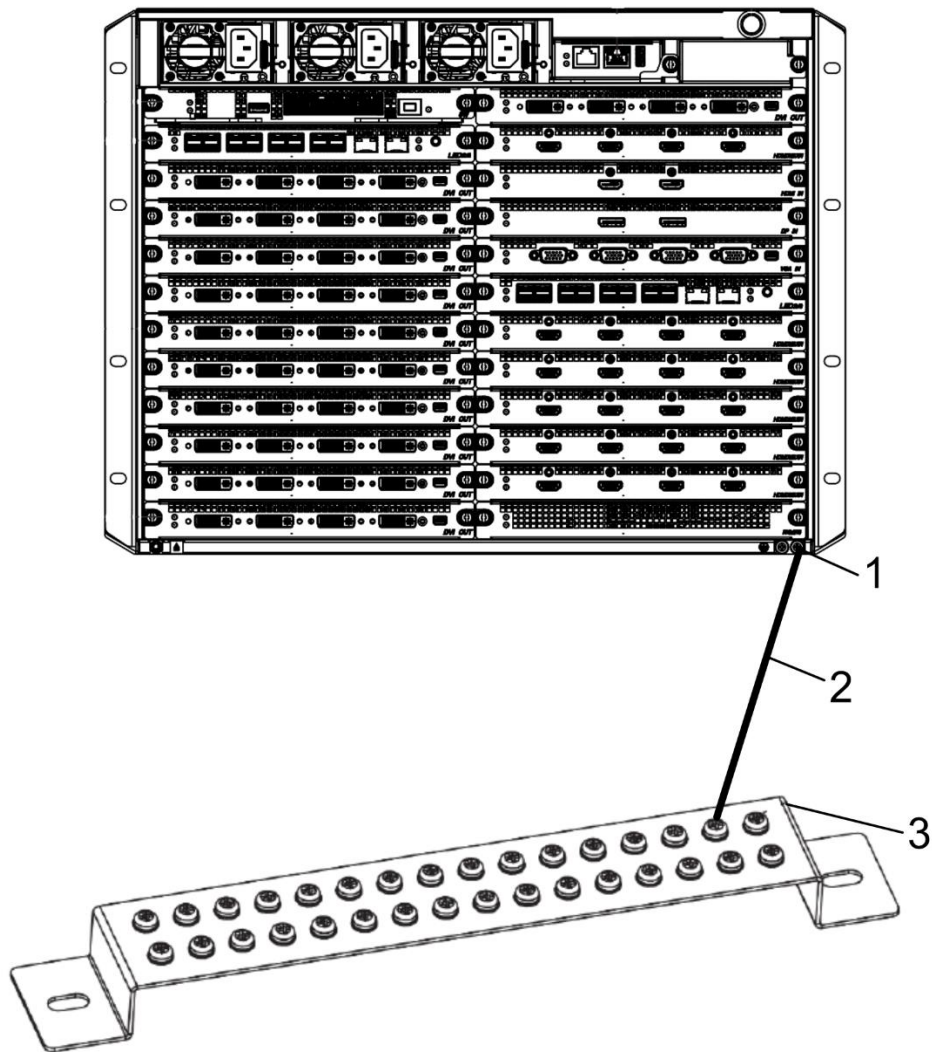

Figure 2-5 Connect the Grounding Cable to the Grounding Row

**Without Grounding Row**

Step 3 Drive an angle steel (4) or steel pipe into the ground (3) of at least 0.5 m.

Step 4 Weld one end of the grounding cable (2) to the angle steel or steel pipe and treat the welding points with corrosion protection (electroplate or coating).

Step 5 Connect the other end of the grounding cable to a grounding terminal (1) of the device.

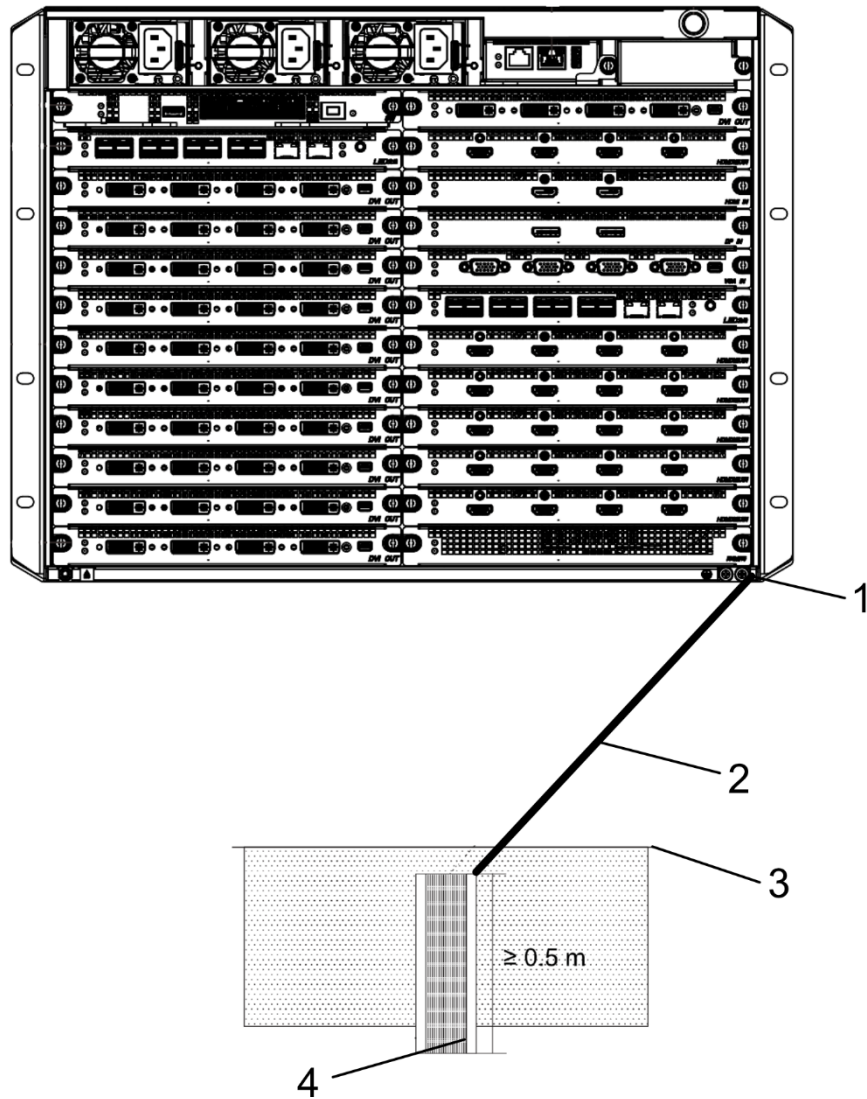

Figure 2-6 Connect the Grounding Cable to the Ground

## 2.4.2 Connect the Network Cable

The device is connected to the network through networking equipment such as switches. The following figure shows the network connection between the device and switch through a network port on the switch board.

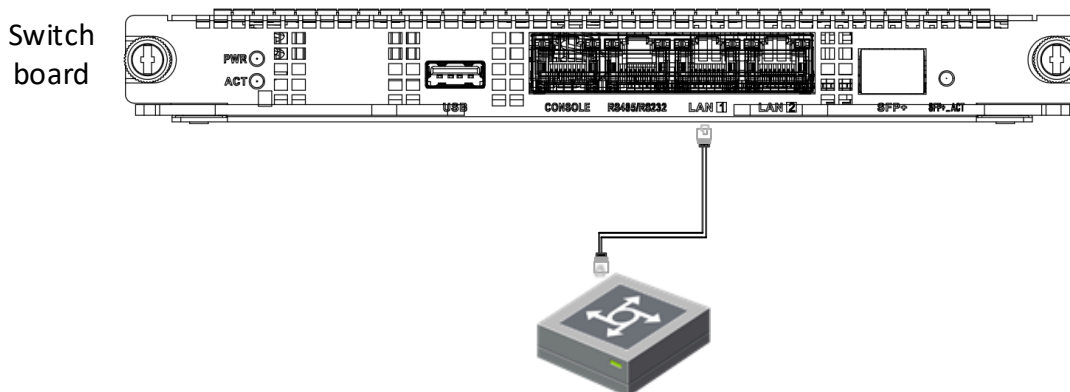

Figure 2-7 Switch Board Network Connection

### ! Caution

- It is recommended to use CAT 6 Ethernet cables for connection.
- By default, two Gigabit Ethernet ports on the device are not aggregated. Configure the port aggregation on the connected switch.

## 2.4.3 Connect the Power Cord

The device uses 2 power supplies for redundancy. The power supply socket locates near the fan. Use two three-phase power cords to connect two power supply sockets to the power supply in the equipment room.

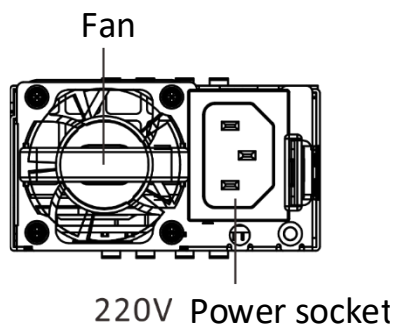

Figure 2-8 Power Supply

## 2.5 Power On the Device

After the power cord is connected for the first time, the device is powered on. When the device runs, you can press and hold the power switch to shut down the device. When the device is powered off, you can press the power switch to power on the device.

## Chapter 3 Get More Information

Scan the QR code below to get more information about the system operation and function configuration. Please refer to the actual device.

---



The following operations require network data traffic and are recommended to be performed in a Wi-Fi environment.

---



Figure 3-1 User Manual



See Far, Go Further