



User Manual KOORUI Monitor

User Manual

Product Parameters

Product Parameters		Physical Properties	
MODEL NO.	24E4	Signal Cable Model	Separable
Display		Power Type	External power supply
LCD Technology	VA	Input Voltage	100~240V 47/63Hz
Reaction Time(G/G)	1ms(MPRT)	Input Current	5mA
Pixel Distance	0.275mm	Power Consumption	Boot ≤30W
Video	HDMI / HDMI / DP		Sleep ≤0.5W
Display Color	16.7M colors	VESA Mount supported	75×75mm
Image Ratio	16 : 9	Product Height	424.2mm
Brightness(typ.)	250cd / m2	Product Width	541.9mm
Resolution	1920×1080	Product Depth	176.3mm
Maximum Refresh Rate	165Hz	Product Weight	3.14±0.2kg
Viewing Angle (H / V)	178° / 178°	FCL Weight	4.45±0.2kg
Static Contrast	3000 : 1	Height adjustment	Not adjustable
Dynamic Contrast	20000000 : 1	Output Port	
Display frequency conversion technology	FreeSync	HDMI 1.4	2
sRGB color gamut	100%	DisplayPort	1
DCI-P3 color gamut	85%	Audio	1
Model Type	Digital Signal	Use Environment	
Language	English, Chinese, German, Japanese, Italian, French optional	Working Temperature	0~40°C
		Storage Temperature	-20~60°C
Eye Protection Mode	Yes	Working Humidity	10%~80%
Built-in Speaker	No	Storage Humidity	5%~95%

Contents







Chapter I Attention	01
1.1 Safety Precautions	01
1.2 Storage Precautions	01
1.3 Securing the Installation Space	02
1.4 Protection Recommendations	02
1.5 Precautions for Moving the Product	03
Chapter II Preparation Before Use	04
2.1 Schematic Diagram of Product Accessories	04
2.2 Holder Installation	04
2.2.1 Monitor Holder Installation	04
2.2.2 VESA Holder Installation	05
2.3 Monitor Holder Removal	06
2.3.1 VESA Holder Disassembly Drawing	06
2.3.2 Holder Disassembly Diagram	07
2.4 Interface and Data Cable Connection Instructions	08
2.5 Adjusting the Product Tilt	09
2.6 Anti-theft Lock	10
2.7 Preset Display Modes	11
Chapter III OSD Function	12
Chapter IV Common Applications	17
4.1 Resolution and Refresh Rate Setting	17
4.2 Extended Application of Display (split screen)	17
4.3 Display Sound Output Setting	17
4.4 Display Direction Setting	17
4.5 Windows Personalized Fonts	17
Chapter V Q&A	18

Chapter I Attention

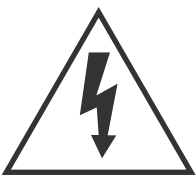
1.1 Safety Precautions

Warning A serious or fatal injury may result if instructions are not followed.

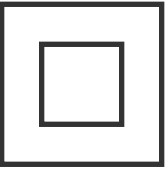
Caution Personal injury or damage to properties may result if instructions are not followed.

Risk of electric shock. don't open			
<p>CAUTION: TO REDUCE RISK OF ELECTRIC SHOCK, DO NOT REMOVE COVER (OR BACK). There are no user serviceable parts inside. Delegate all services to qualified personnel.</p>			
	<p>This symbol indicates that high voltage is present inside. It is dangerous to make any kind of contact with any internal part of this product.</p>		<p>AC voltage: Rated voltage marked with this symbol is AC voltage.</p>
	<p>This symbol indicates that this product has included important literature concerning operation and maintenance.</p>		<p>DC voltage: Rated voltage marked with this symbol is DC voltage.</p>
	<p>Class II product: This symbol indicates that a safety connection to electrical earth (ground) is not required. If this symbol is not present on a product with a mains lead, the product MUST have a reliable connection to protective earth (ground).</p>		<p>Caution. Consult instructions for use: This symbol instructs the user to consult the user manual for further safety related information.</p>

1.2 Storage Precautions

- Keep away from water sources or damp places, such as bathrooms, kitchens, basements, swimming pools, etc.
- Ensure that the equipment is installed and placed smoothly. If it falls, it may cause human injury or equipment damage.
- Store in a cool, dry and ventilated place, and do not approach radiation sources and heat sources.
- Do not cover or plug the ventilation holes in the back shell, and do not use them on beds, sofas, blankets or similar surfaces.

- The power supply voltage range of equipment operation is indicated on the label of the back shell. If the supplied voltage cannot be determined, consult the local power company.
- When the monitor is not used for a long time, please cut off the power supply to prevent the damage of the motor and abnormal power supply voltage in thunderstorm days.
- Do not overload the socket, which may cause fire and electric shock.
- Please do not put foreign bodies into the machine, which may cause short circuit or cause fire and electric shock.
- Please do not disassemble or repair this product by yourself. If there is any fault, please contact the after-sales service personnel directly.
- Please do not pull or twist the power cord excessively.

1.3 Securing the Installation Space

Make sure to have enough space for ventilation when placing the product. An internal temperature rise may cause fire and damage the product. Maintain enough space around the product as shown in the diagram when installing the product.

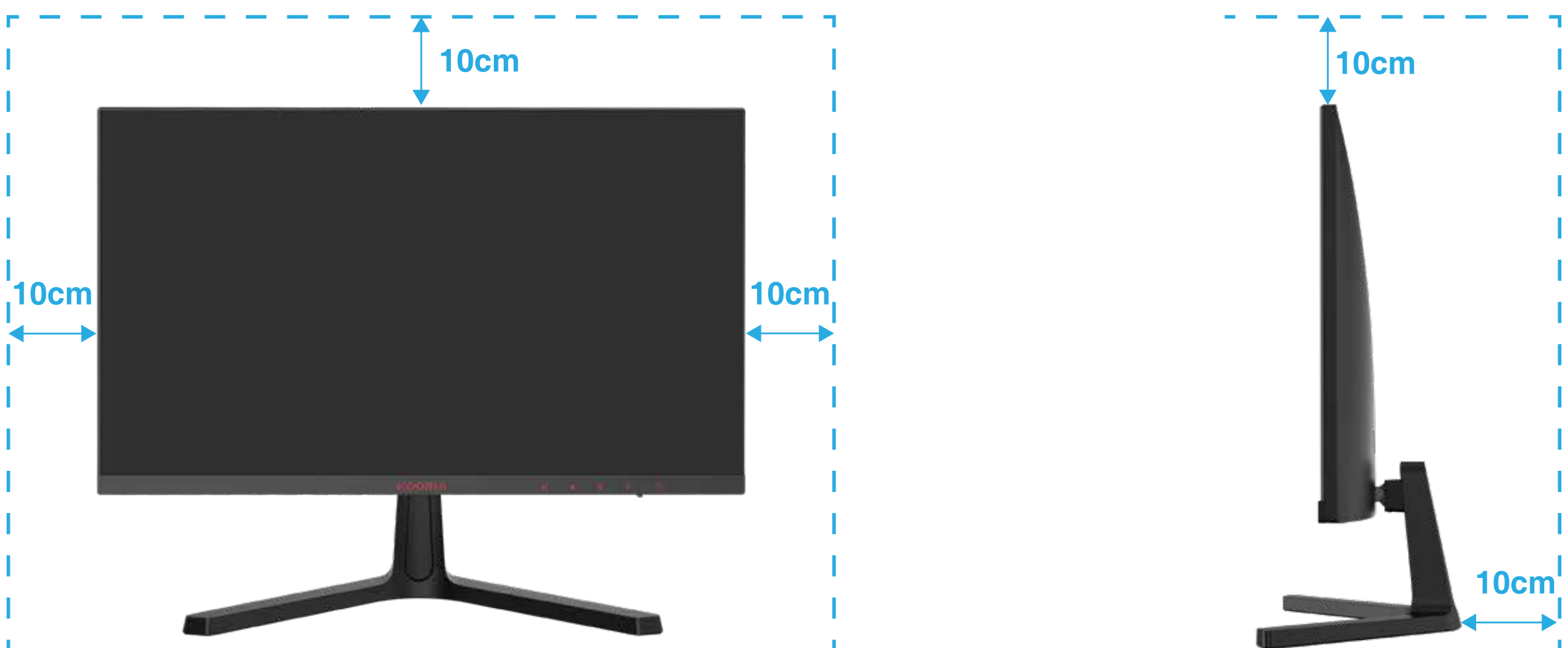

1.4 Protection Recommendations:

Suggestions for eyes

In order to avoid eye fatigue and pain in neck, arms, back and shoulders caused by long-term use of the monitor, please pay attention to the following points:

- Place the monitor 20-28 inches away from both eyes (about 50-70cm).
- Use the monitor to keep the eyes moist or increase the blinking frequency.
- After using the monitor for 2 hours, please rest for 20 minutes.

- When resting, leave your eyes away from the monitor and look at the distance for 20 seconds.
- When resting, stretch or relieve your neck, arms, back and shoulders.

Low blue light description

The blue light wavelength is in the blue light band, and the display has the function of reducing blue light emission. Can select "eye protection mode" in the menu to protect your eyes.

Cleaning your monitor

To clean your screen, lightly dampen a soft, clean cloth with water. If possible, use a special screen-cleaning tissue or solution suitable for the anti static coating. Do not use benzene, thinner, ammonia, abrasive cleaners or compressed air.

1.5 Precautions for Moving the Product



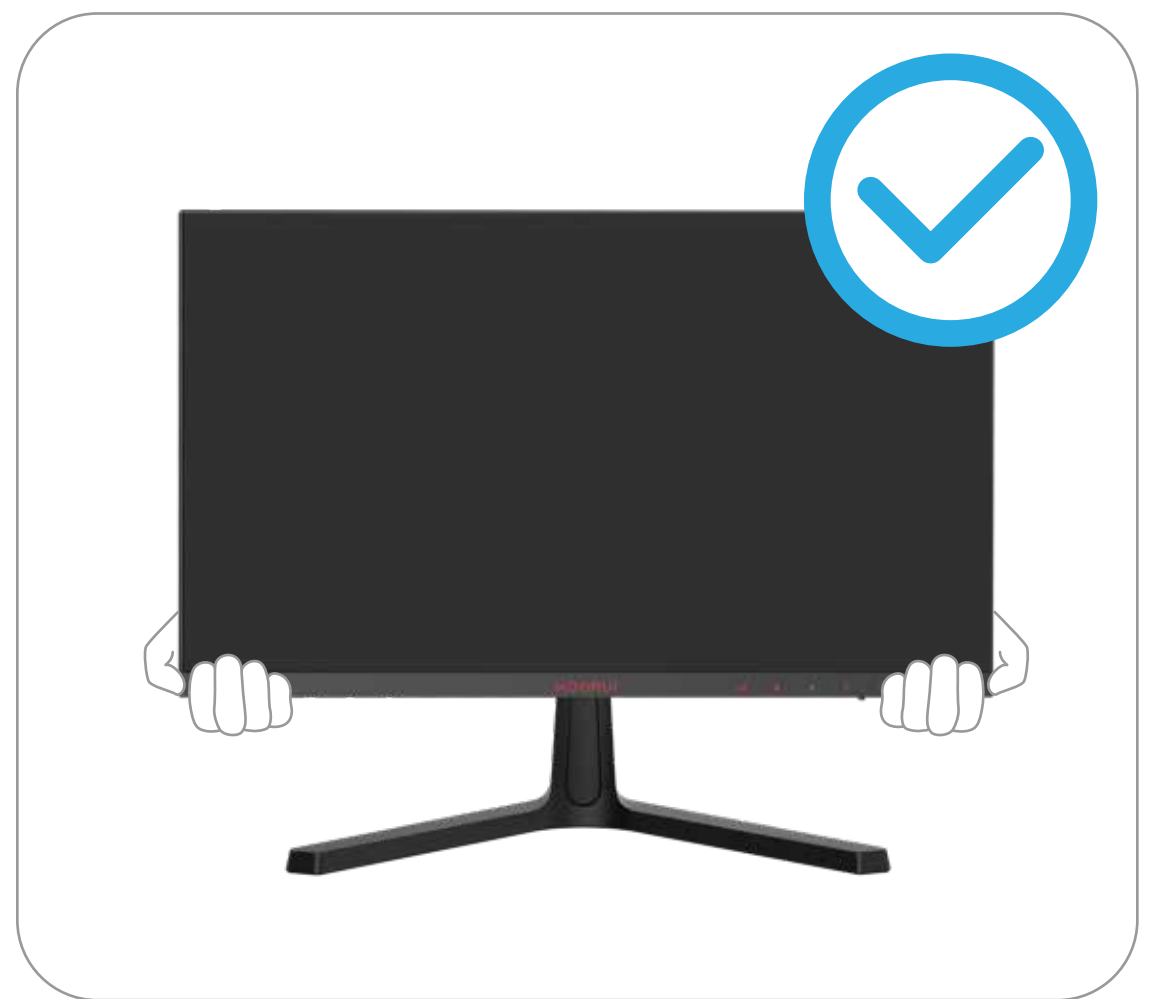







- Do not directly apply pressure on the screen.
- Do not hold the screen when moving the product.
- Hold the lower corners or edges of the product when moving it.



Chapter II Preparation Before Use

2.1 Accessories:

Your monitor is equipped with the following components. Please check whether all parts have been received. If there are any omissions, please contact Koorui.

				
Outer box	Monitor	Stand neck	Base	Base accessories
				
DisplayPort Cable	User Manual	Base Screw*1PCS	Stand neck Screw*2	Adapter

2.2 Holder Installation:

2.2.1 Monitor Holder Installation



Snap into stand



Lock the screw

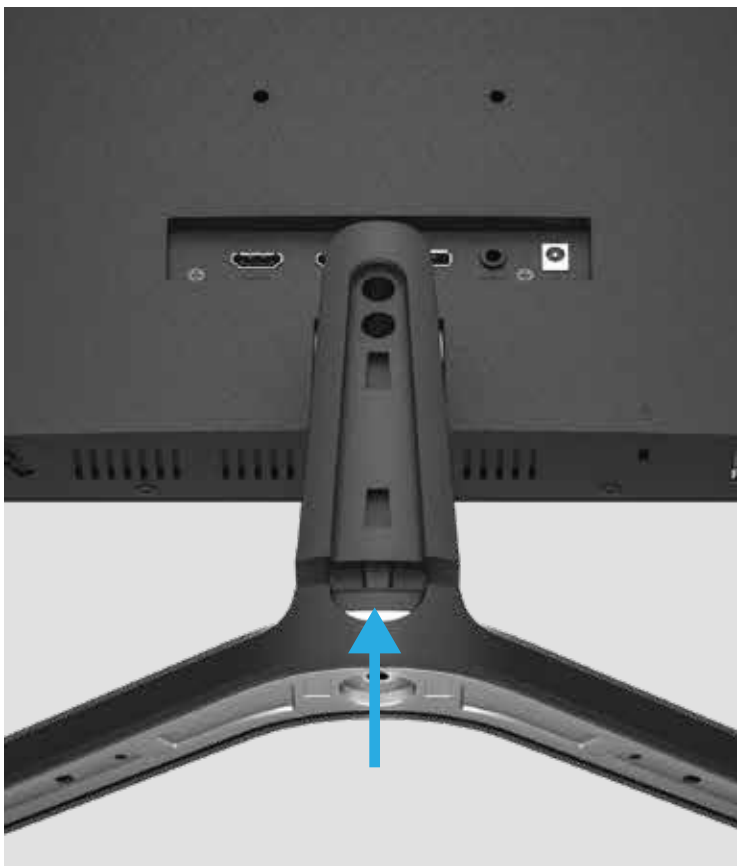

Push in the base.

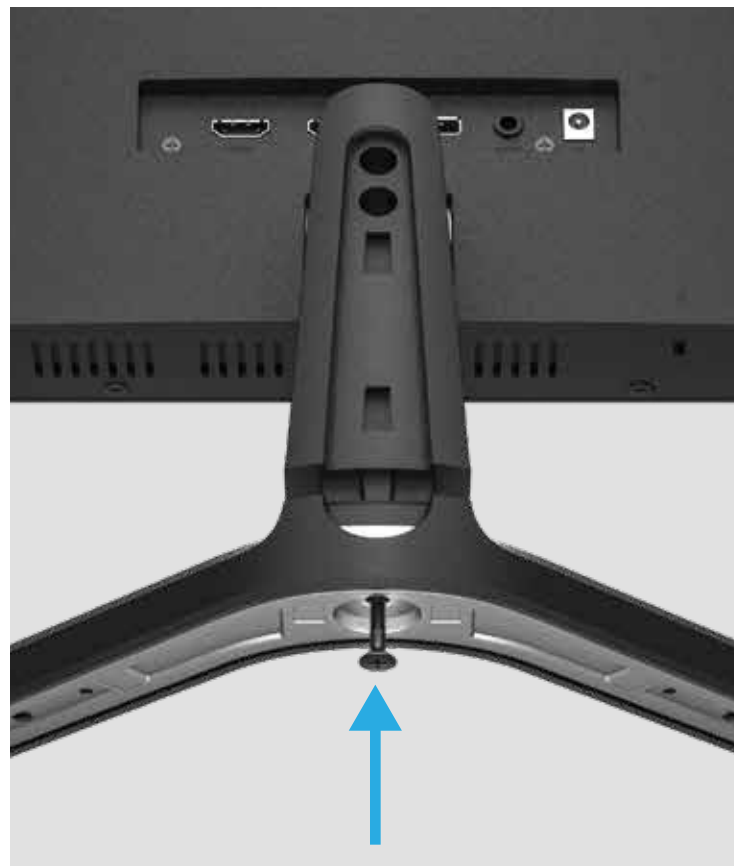

Lock the screw



Tilt and push in the base bracket.

2.2.2 VESA holder Installation &Attention

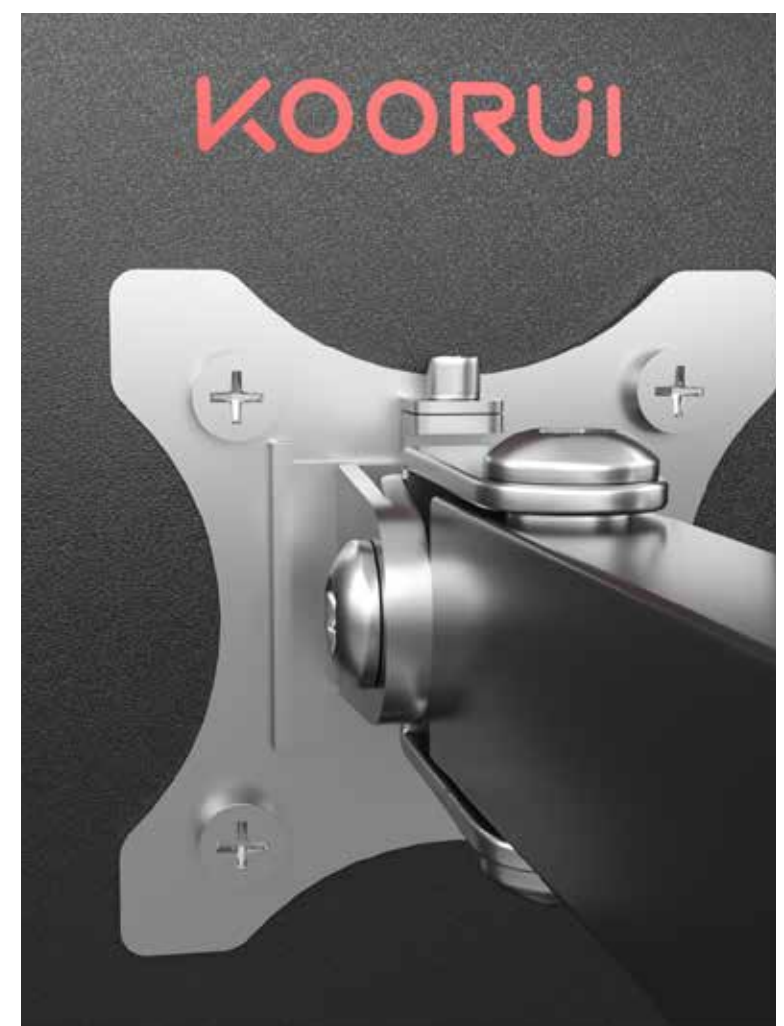

Wall mounting screws require M4 screws, the length should not exceed 7MM.

VESA Attention

- VESA device can be purchased separately.
- Refer to the user guide provided with your VESA device for details.

- Install your wall mount on a solid wall perpendicular to the floor. Before attaching the wall mount to surfaces other than plaster board, please contact your nearest dealer for additional information. If you install the product on a slanted wall, it may fall and result in severe personal injury.
- Do not mount the product at more than 15 degree tilt.
- Assemble VESA holder (using retaining screws removed from rear shell)

2.3 Holder removal

2.3.1 VESA Holder removal



2.3.2 Monitor Holder removal



Thumb preload



Tilt push out

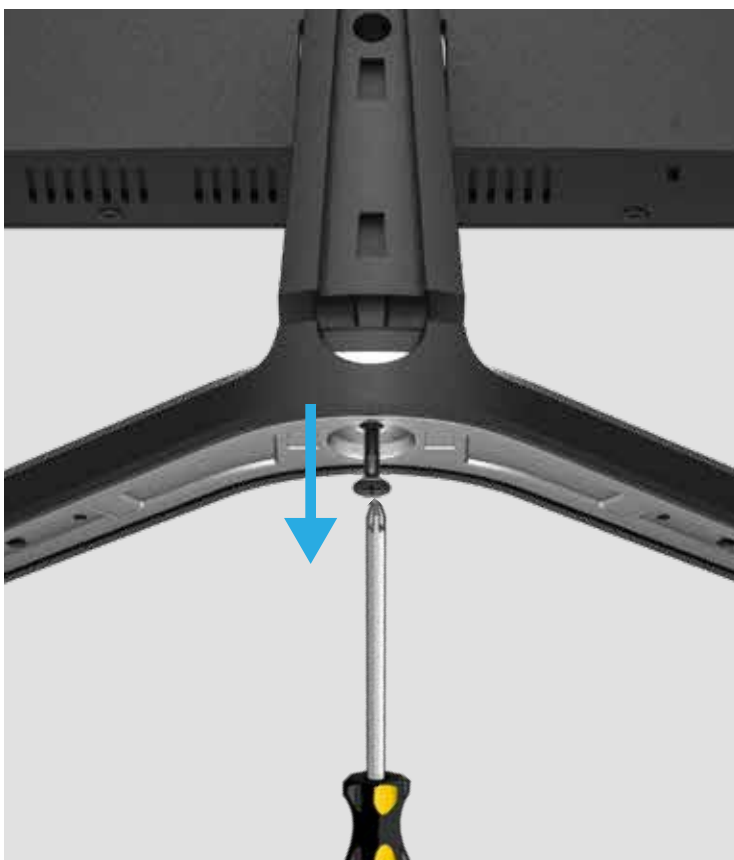

Using a Phillips screwdriver remove the screws.



Take out the base.







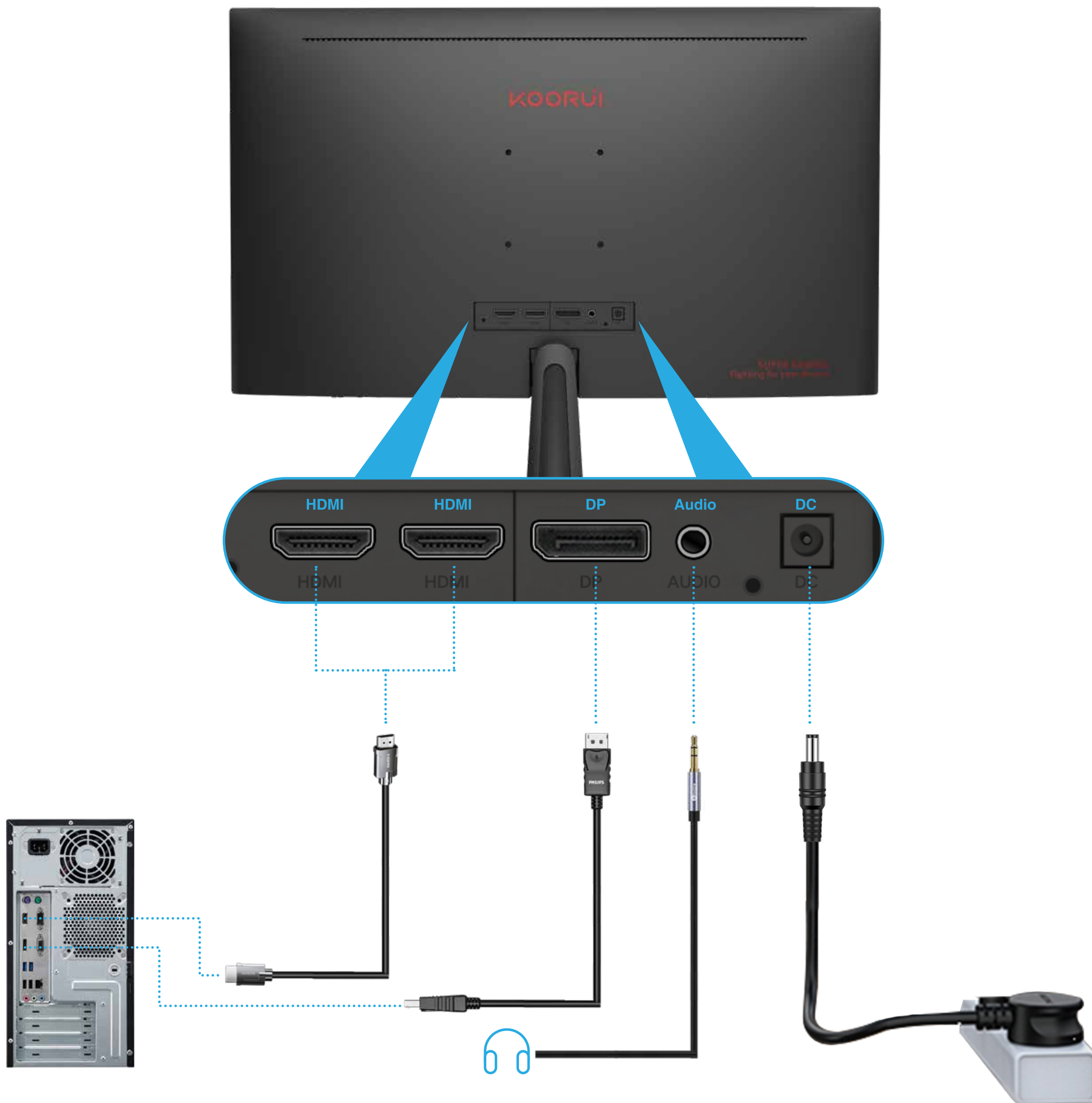

Remove the screw to remove the stand

Please keep the screws in a sealed bag and use them again.

2.4 Interface and Data Cable Connection Instructions



Port	Port Description
 	Connect to an audio output device such as headphones or earphones. <i>Note: Converting DVI and VGA does not support sound mode.</i>
 HDMI IN 1  HDMI IN 2	Connects to a PC using a HDMI cable.
	Connects to a PC using a DisplayPort cable.
	Connects to the DC cable.

Connecting and using a PC

- Choose the connection method that suits your PC.
- Connecting parts may vary from product to product.
- HDMI Port supports up to 1920x1080, 144Hz;
- DP port supports up to 1920x1080, 165Hz;

Connecting and using source devices

Read below before installing the product.

- Before installing the product, check the shapes of both ports of the supplied signal cables and the shapes and locations of the ports on the product and external device.
- Before connecting signal cable, make sure you remove the power cables from both the product and the external device to prevent damage to the product due to a short circuit or over current.
- After all signal cables have been properly connected, connect the power cables back to the product and the external device.
- After installation is completed, make sure you read the user guide to acquaint yourself with the product functions, precautions and other information required to use the product properly.

Please read the user guide provided by the source device for the operation mode of the source device. The original device signal is abnormal. It is recommended to contact the source device manufacturer first.

If you need assistance, please contact Koorui customer services.

2.5 Adjusting the Product Tilt



2.6 Anti-theft Lock

- An anti-theft lock allows you to use the product securely even in public places.
- The locking device shape and locking method depend on the manufacturer.

To lock an anti-theft locking device:

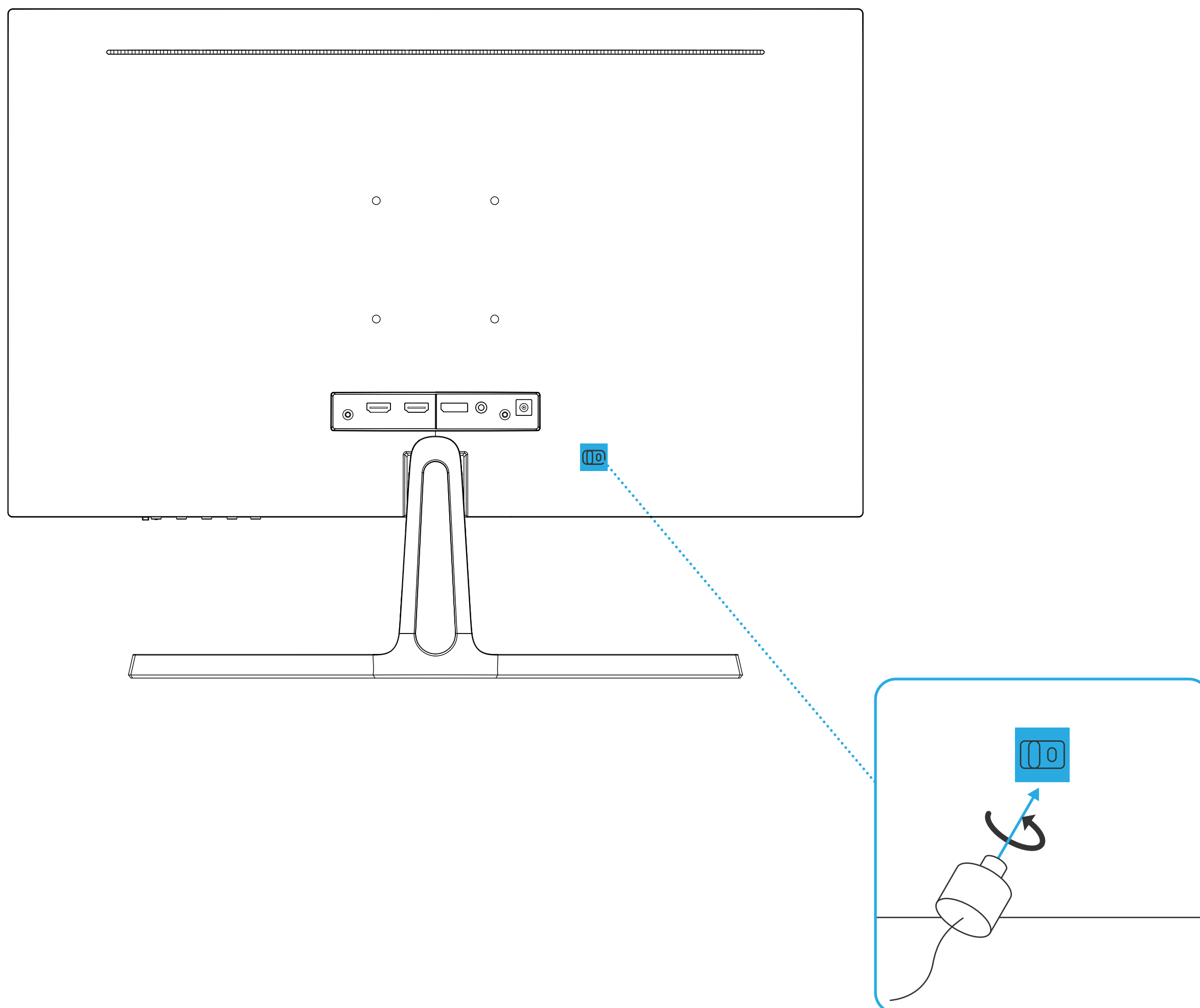





- An anti-theft locking device can be purchased separately.
- Refer to the user guide provided with your anti-theft locking device for details.



2.7 Preset display modes









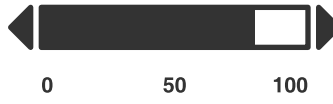
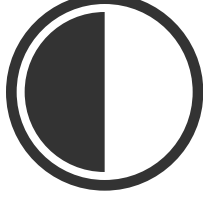
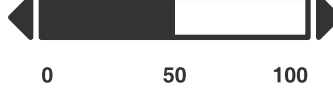
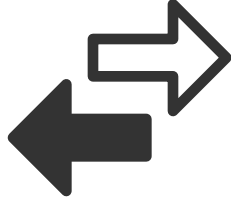

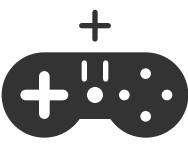
NO.	Resolution	Horizontal Frequency (kHz)	Vertical Frequency (Hz)
1	720x400@70Hz	31.469	70.087
2	640x480@60Hz	31.469	59.94
3	640x480@72Hz	37.861	72.809
4	640x480@75Hz	37.5	75
5	800x600@60Hz	37.879	60.317
6	800x600@72Hz	48.077	72.188
7	800x600@75Hz	46.875	75
8	1024x768@60Hz	48.363	60.004
9	1024x768@70Hz	56.476	70.069
10	1024x768@75Hz	60.023	75.029
11	1280x1024@60Hz	63.981	60.02
12	1280x1024@75Hz	79.976	75.025
13	1280x1024@120Hz	130	120
14	1440x900@60Hz	55.469	59.901
15	1600x900@120Hz	114.2	120
16	1680x1050@60Hz	64.674	59.883
17	1680x1050@120Hz	133.4	120
18	1920x1080@60Hz	67.5	60
19	1920x1080@120Hz	137.26	120
20	1920x1080@144Hz	161.47	144
21	1920x1080@165Hz	183.15	165

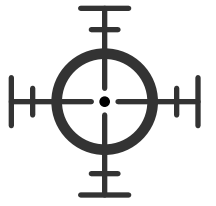

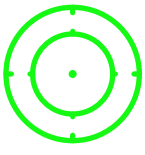

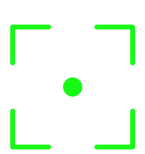







Chapter III OSD Function









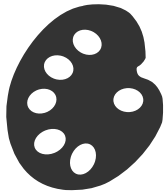

The OSD function information table of this product is as follows. If there is any question about the operation process, please contact Koorui customer services.

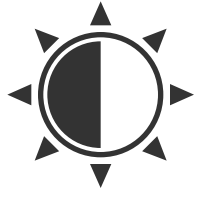

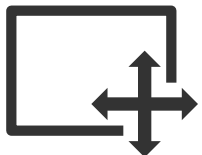
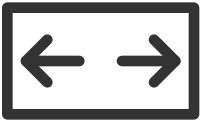



M	Menu	Press this button to display the main menu, return to the previous menu or exit the main menu.
	Left	When the menu is opened, press this button to select the left item, and the value of the progress bar will decrease. When the menu is closed, act as the specified shortcut volume mode hotkey. Hotkey function: volume down (when M menu is not open).
	Right	When the menu is opened, press this button to select the right item, and the value of the progress bar will increase. When the menu is closed, act as the specified shortcut volume mode hotkey.
E	Accessing menu	If the menu is active, pressing this key selects the function.
	Power button	Press it to turn on/off the monitor.
	Power LED	Remains on : normal working state ; Flashes : power-saving standby state.

First order menu	Secondary menu	Tertiary menu	Description
 Display	 Brightness		Can adjust the brightness of your display by pressing the left and right key -/+.
	 Contrast		Can adjust the Contrast of your display by pressing the left and right key -/+.
	 DCR	ON OR OFF	ON: Turn On; OFF: Turn Off Automatic identification output dynamic adjustment can be selected; If you choose dynamic contrast, manually adjusting brightness and darkness will automatically turn off.

 Language	Chinese	/	After confirmation by "E", the OSD menu options will be changed to Chinese language.	
	English	/	After confirmation by "E", the OSD menu options will be changed to English language.	
	French	/	After confirmation by "E", the OSD menu options will be changed to French language.	
	Deutsch	/	After confirmation by "E", the OSD menu options will be changed to Deutsch language.	
	Italian	/	After confirmation by "E", the OSD menu options will be changed to Italian language.	
	Japanese	/	After confirmation by "E", the OSD menu options will be changed to Japanese language.	
 Game mode	 OD mode	ON OR OFF	ON: Turn On; OFF: Shutdown Turn on OD mode.	
	 Crosshair			Confirm the use of this sight graphic sight (supported by the source equipment).
				Confirm the use of this sight graphic sight (supported by the source equipment).
				Confirm the use of this sight graphic sight (supported by the source equipment).
				Confirm the use of this sight graphic sight (supported by the source equipment).
				Confirm the use of this sight graphic sight (supported by the source equipment).
				Confirm the use of this sight graphic sight (supported by the source equipment).
	 FreeSync Premium	ON OR OFF	ON: Turn On; OFF: Shutdown Open freesync (need your source device support, open the display freesync before using).	
	 MPRT		ON: Turn On; OFF: Shutdown Turn on MPRT mode.	

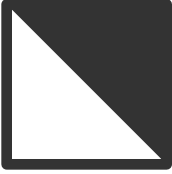
	 Timer		After selection, turn on the 30-minute timer function (countdown will appear in the upper left corner).
			After selection, turn on the 40-minute timer function (countdown will appear in the upper left corner).
			After selection, turn on the 50-minute timer function (countdown will appear in the upper left corner).
			After selection, turn on the 60-minute timer function (countdown will appear in the upper left corner).
			After selection, turn on the 90-minute timer function (countdown will appear in the upper left corner).
			Turn off Timer Mode.
 Preset Mode	 Standard	/	turn on Standard mode.
	 MOVIE	/	turn on Movie mode.
	 FPS	/	turn on FPS mode.
	 RTS	/	turn on RTS mode.
	 Eye Saver	/	turn on eye protection mode.

 <p>Color temperature</p>	 <p>Cool</p>	/	When confirmed, turn on cool color temperature mode (when turned on, DCI-P3 mode will be automatically exited).
	 <p>Warm</p>	/	When confirmed, Turn on warm color temperature mode (when turned on, DCI-P3 mode will be automatically exited).
	 <p>User</p>	R	Adjust the red saturation level. A value closer to 100 means a stronger color.
		G	Adjust the green saturation level. A value closer to 100 means a stronger color.
		B	Adjust the blue saturation level. A value closer to 100 means a stronger color.
 <p>DCI-P3</p>	/	DCI-P3 mode.	
 <p>Aspect Ratio</p>	AUTO	/	After selection, automatically find the input source.
	 <p>16 : 9</p>	/	Select to display the image of the sub-screen with an aspect ratio of 16 : 9.
	 <p>4 : 3</p>	/	Select an aspect ratio of 4: 3 to display the image of the sub-screen. Applicable to video and standard broadcasting.
 <p>Input Source</p>	 <p>HDMI 1</p>	/	Select HDMI 1 Signal Input (HDMI 1.4 port).
	 <p>HDMI 2</p>	/	Select HDMI 2 Signal Input (HDMI 2.0 port).
	 <p>DisplayPort</p>	/	Select DisplayPort Signal Input (DisplayPort port).

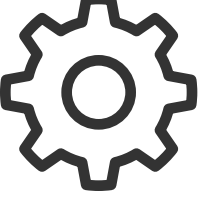
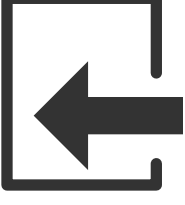
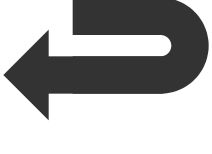
 Other	 Power Off	ON OR OFF	ON: Turn On; OFF: shutdown Turn on the timed shutdown, and the display will be automatically turned off after 4H.
	 Gamma	 Gamma 1	Select Gamma Mode 1 to use.
		 Gamma 2	Select Gamma Mode 2 to use.
	 Volume	/	Adjust the sound size. The higher the value, the louder the sound.
 Reset	YES OR NO	/	In addition to OSD language, you can reset your other option settings and revert to the factory settings of the product.
 Exit	/	/	
/	 Return	/	Return to the previous menu (this selection only appears in the second\ third order settings).

Precautions:

- When you are not watching movies or games, it is best to set the response time and mode to standard.
- Under dynamic contrast, brightness and contrast cannot be adjusted.
- Image ratio and MPRT cannot be adjusted under FREESYNC.
- Standard mode, get the clearest display effect, and adjust it according to your preference
- Cinema mode, eye protection mode, FPS mode and RTS mode cannot adjust brightness and contrast.
- Eye protection mode cannot adjust color temperature.
- In MRPT mode, OD acceleration cannot be started.
- If you have any other questions, you can contact Koorui customer service.

Chapter IV Common Applications

(In the case of Windows 10)

4.1 Resolution and Refresh Rate Setting

4.1.1 Resolution settings

Windows Settings → System → Screen → Display Resolution

4.1.2 Refresh rate setting

Windows Settings → System → Screen → Advanced Display Settings
→ Refresh Rate

In Multiple Screen Control, in Advanced Display Settings, select the display you want to set

4.2 Extended Application of Display (split screen)

Screen expansion function setting.

Windows Settings → System → Screen → Multiple Display Settings
→ Select "Expand This Display"

4.3 Display Sound Output Setting

HDMI, DP sound effect selection.

Windows Settings → System → Sound → Output → Select Output Settings.

4.4 Display Direction Setting

Windows Settings → System → Screen → Display Direction

4.5 Windows Personalized Fonts

(Including: blurred fonts, desktop fonts with colors)

Windows Settings → Personalize → Font → Adjust ClearType text and change
Turn on ClearType.

Chapter V Q&A

- The following table lists some common monitor problems that you may encounter and their solutions.
- If you can't solve your difficulties, please contact Koorui customer services.
- Official website: <http://www.koorui.net/>
- E-mail: support@koorui.net

Blank spaces are found on all four sides of the screen when an HDMI or DP cable is connected to the product and PC.	The blank spaces found on the screen have nothing to do with the product. Blank spaces on the screen are caused by the PC or graphics card. To resolve the problem, adjust the screen size in the HDMI or DP settings for the graphics card. If the graphics card settings menu does not have an option to adjust the screen size, update the graphics card driver to the latest version. (Please contact the graphics card or PC manufacturer for further details about how to adjust the screen settings.)
The power LED is off. The screen will not turn on.	Check that the power cable is connected properly. If a problem occurs with the monitor screen, run Self Diagnosis to check that the monitor is working properly.
Not Optimum Mode is displayed.	This message appears when the signal from the graphics card exceeds the maximum resolution or frequency for the product. Change the maximum resolution and frequency to suit the product performance.
The images on the screen look distorted.	Check the cable connection to the product.
The screen is not clear or blurry.	Remove any accessories (video extension cable, etc.) and try again. Set the resolution and frequency to the recommended level.
The screen appears unstable and shaky. There are shadows or ghost images left on the screen.	Check that the resolution and frequency for the PC are within the range of resolution and frequency compatible with the product. Next, if required, change the settings, referring to Standard Signal Mode.
The screen is too bright or too dark.	Adjust Brightness and Contrast.
Screen colour is inconsistent. The colour on the screen have a shadow and are distorted. White does not really look white.	Change the Color Settings.

<p>There is no image on the screen and the power LED blinks every 0.5 to 1 second.</p>	<p>The product is operating in power-saving mode. Press any key on the keyboard or move the mouse to return to normal operating mode. Observe whether the computer operates or restarts the device through the PC keyboard Caps Lock.</p>
<p>Video playback is choppy.</p>	<p>Playback of high-definition large video files can be choppy. This may be because the video player is not optimized for the PC resource. Try playing the file on another video player.</p>
<p>The monitor is no sound.</p>	<p>If the input device is connected using an HDMI-DVI cable, no sound will be heard. You should be connect the device using an HDMI cable or a DP cable.</p> <p>Re-check the condition of the connected audio cable and/or adjust the volume. Check the volume. Check whether audio is set to mute. The monitor sound output is not set, refer to [4.3 Display Sound Output Setting]</p>
<p>The volume is too low.</p>	<p>Volume adjustment. If the volume is still low after turning it up to the maximum level, adjust the volume on your PC sound card or software programme.</p>
<p>Video is available but there is no sound.</p>	<p>No sound can be heard if the input device is connected with an HDMI-DVI cable. Connect the device using an HDMI cable or a DP cable. The monitor sound output is not set, refer to [4.3 Display Sound Output Setting]</p>
<p>An energy efficiency prompt appears on the monitor or "XXS Power down. MENU Key Cancel" appears in the upper left corner of the monitor</p>	<p>When you buy and sell European products, European regulations have energy efficiency requirements</p>
<p>The monitor quickly goes to a black screen state (no display)</p>	<p>Under the power setting state, the monitor is turned off for a short time Windows settings==>system==>power and sleep==>screen==>Reset the TIME</p>