

CT47 ULTRA-RUGGED MOBILE COMPUTER

Configuration Guide



SCAN HANDLE



RFID



VEHICLE DOCK



CT47



**CT47 NI
NON-INCENDIVE
ATEX / IEC Ex**

THE
FUTURE
IS
WHAT
WE
MAKE IT

Honeywell

TABLE OF CONTENTS

- 1 TABLE OF CONTENTS**
- 2 CT47 FEATURE OVERVIEW**
 - S0703 STANDARD RANGE
 - N6803 FLEXRANGE™ NEAR/ FAR RANGE
 - S0803 FLEXRANGE™ XLR NEAR/ EXTRA LONG RANGE
 - NON-INCENDIVE / ATEX / IEC EX - S0803 FLEXRANGE™ XLR NEAR/ EXTRA LONG RANGE
- 6 CT47 CONFIGURATION MAP**
 - ANDROID
- 7 HONEYWELL EDGE SERVICES**
 - GOLD REPAIR SERVICES - 3 YEAR
 - PLATINUM REPAIR SERVICES - 3 YEAR
 - GOLD REPAIR SERVICES - 5 YEAR
 - PLATINUM REPAIR SERVICES - 5 YEAR
 - CT47 - REPAIR SERVICES COVERAGE
- 10 CT47 SOFTWARE**
 - DEVICE CLIENT PACK
- 11 CT47 SCANNING**
 - SCAN HANDLE SIDE BY SIDE COMPARISON
 - OPTION 1 - SCAN HANDLE
 - OPTION 2 - SCAN HANDLE WITH PROTECTIVE BOOT
 - DOCKABLE PROTECTIVE BOOT
- 15 CT47 DESKTOP COMMUNICATIONS**
 - OPTION 1 – PORTABLE - NON-BOOTED OR BOOTED
 - OPTION 2 – FIXED WITH UNIVERSAL CUP
 - OPTION 3 – USB TYPE C ON-THE-GO (OTG) DESKTOP
 - OPTION 4 – USB TYPE C ON-THE-GO (OTG) VEHICLE
 - OPTION 5 - DISPLAY BASE WITH UNIVERSAL CUP
- 18 CT47 VEHICLE INSTALL**
 - OPTION 1 – PORTABLE/ SUB CONTRACTOR INSTALL
 - OPTION 2 – PORTABLE/ SUB CONTRACTOR INSTALL
 - OPTION 3 - FIXED VEHICLE INSTALL WITH DIRECT CONNECTION TO VEHICLE BATTERY
 - OPTION 4 - FIXED VEHICLE INSTALL WITH DIRECT CONNECTION TO VEHICLE BATTERY - EXTERNAL SPEAKER
 - OPTION 5 - FIXED VEHICLE INSTALL WITH DIRECT CONNECTION TO VEHICLE BATTERY/ FUSE BLOCK
 - OPTION 6 - FIXED VEHICLE INSTALL WITH DIRECT CONNECTION TO VEHICLE BATTERY/ FUSE BLOCK – EXTERNAL SPEAKER
 - OPTION 7 - FIXED VEHICLE INSTALL WITH THOR DC/DC CONVERTER
 - OPTION 8 - FIXED VEHICLE INSTALL WITH THOR DC/DC CONVERTER - EXTERNAL SPEAKER
 - CT45/ CT47 VEHICLE DOCK (CT45-VD-CNV) DETAIL VIEW - NON-BOOTED
 - CT45/ CT47 VEHICLE DOCK (CT45-VD-CNV) DETAIL VIEW - BOOTED
 - CT45/ CT47 VEHICLE DOCK WITH EXTERNAL SPEAKER (CT45-VD-CNV-SPK) DETAIL VIEW - NON-BOOTED
 - CT45/ CT47 VEHICLE DOCK WITH EXTERNAL SPEAKER (CT45-VD-CNV-SPK) DETAIL VIEW - BOOTED
- 29 CT47 CHARGING AND COMMUNICATION**
 - OPTION 1 - NON-BOOTED QUAD CHARGER WITH UNIVERSAL CUP
 - OPTION 2 - BOOTED QUAD CHARGER WITH UNIVERSAL CUP
 - OPTION 3 - NON-BOOTED 5-BAY CHARGER WITH BATTERY CUP
 - OPTION 4 - BOOTED 5-BAY CHARGER WITH BATTERY CUP
 - OPTION 5 - NON-BOOTED 5-BAY CHARGER WITH UNIVERSAL CUPS
 - OPTION 6 - BOOTED 5-BAY CHARGER WITH UNIVERSAL CUPS
 - OPTION 7 - QUAD BATTERY CHARGER
 - OPTION 8 - 1-BAY QUAD BATTERY CHARGER WITH UNIVERSAL CUP
- 33 CT47 CHARGING AND COMMUNICATION**
 - RACK / WALL MOUNT BRACKET
- 34 CT47 BATTERY**
 - SPARE BATTERY OPTIONS
- 35 CT47 RFID**
 - IH40 RFID READER WITH CT47 NON-BOOTED
 - IH40 RFID READER WITH CT47 BOOTED
- 37 CT47 RFID CHARGING**
 - OPTION 1 - IH40 NON-BOOTED QUAD CHARGER
 - OPTION 2 - IH40 BOOTED QUAD CHARGER
 - OPTION 3 - IH40 QUAD BATTERY CHARGER
- 39 CT47 HEADSET**
 - USB-C CT47 PUSH TO TALK (PTT) HEADSET
- 40 MISCELLANEOUS**
 - OPTIONAL PARTS
 - MICRO-SD CARDS
 - AC CORDS

CT47 FEATURE OVERVIEW

S0703 Standard Range



Warm Battery Swap



Display



5G / GPS



Wi-Fi 6E / BT

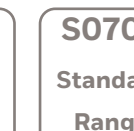

Scanner

Included in the box:

- CT47 Mobile Computer
- Battery (CT4X-BTSC-001)
- USB Type C cable
- Hand strap
- SIM/SD Card Cover Screw

(Stylus is NOT included, but available to order separately as an accessory)



S0703 Standard Range



CT47 Android - 5G WWAN - S0703 - 8GB RAM/ 128GB Flash

CT47-X1N-57D1E0G

CT47, 5G WWAN, 5.5 inch Display, Wi-Fi 6E 802.11 a/b/g/n/ac/d/h/i/r/k/v/w/mc/ax, 2x2 MU-MIMO, BT5.2 & 2nd BLE, 8GB RAM/128GB Flash, S0703 Standard Range, 13MP Rear Camera / 8MP Front Camera, Fingerprint Sensor, Android (GMS), Device Client Pack (DCP) Pre-Loaded (1 Year DCP Term License), 1 x Nano SIM & 1 x eSIM, Standard, 4,775mAh Standard Battery, Global

CT47 Android - 5G WWAN - S0703 - 6GB RAM/ 128GB Flash

CT47-X1N-37D1E0G

CT47, 5G WWAN, 5.5 inch Display, Wi-Fi 6E 802.11 a/b/g/n/ac/d/h/i/r/k/v/w/mc/ax, 2x2 MU-MIMO, BT5.2 & 2nd BLE, 6GB RAM/128GB Flash, S0703 Standard Range, 13MP Rear Camera / 8MP Front Camera, Fingerprint Sensor, Android (GMS), Device Client Pack (DCP) Pre-Loaded (1 Year DCP Term License), 1 x Nano SIM & 1 x eSIM, Standard, 4,775mAh Standard Battery, Global

CT47 Android - Wi-Fi Only - S0703 - 8GB RAM/ 128GB Flash

CT47-X0N-57D100G

CT47, WLAN, 5.5 inch Display, Wi-Fi 6E 802.11 a/b/g/n/ac/d/h/i/r/k/v/w/mc/ax, 2x2 MU-MIMO, BT5.2 & 2nd BLE, 8GB RAM/128GB Flash, S0703 Standard Range, 13MP Rear Camera / 8MP Front Camera, Fingerprint Sensor, Android (GMS), Device Client Pack (DCP) Pre-Loaded (1 Year DCP Term License), Standard, 4,775mAh Standard Battery, Global

CT47 Android - Wi-Fi Only - S0703 - 6GB RAM/ 128GB Flash

CT47-X0N-37D100G

CT47, WLAN, 5.5 inch Display, Wi-Fi 6E 802.11 a/b/g/n/ac/d/h/i/r/k/v/w/mc/ax, 2x2 MU-MIMO, BT5.2 & 2nd BLE, 6GB RAM/128GB Flash, S0703 Standard Range, 13MP Rear Camera / 8MP Front Camera, Fingerprint Sensor, Android (GMS), Device Client Pack (DCP) Pre-Loaded (1 Year DCP Term License), Standard, 4,775mAh Standard Battery, Global

Honeywell Repair Services

SVCCT47-SG3N

CT47, Edge Service, Gold Maintenance Contract, 3 Year, New Contract

ADD SVCREPLACE-MOB3

AddOn, Edge Service, Device Replacement, Mobility, 3 Year

CT47 FEATURE OVERVIEW

N6803 FlexRange™ Near/ Far Range

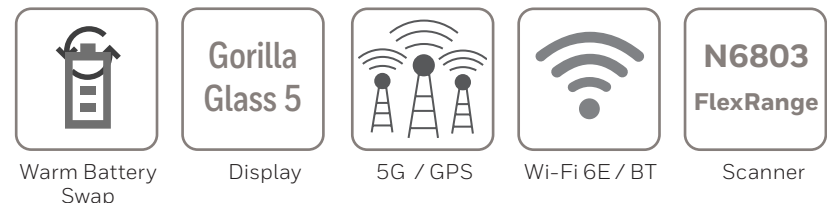

Included in the box:

- CT47 Mobile Computer
- Battery (CT4X-BTSC-001)
- USB Type C cable
- Hand strap
- SIM/SD Card Cover Screw

(Stylus is NOT included, but available to order separately as an accessory)



N6803 FlexRange™



CT47 Android - 5G WWAN - N6803 - 8GB RAM/ 128GB Flash

CT47-X1N-58D1EOG

CT47, 5G WWAN, 5.5 inch Display, Wi-Fi 6E 802.11 a/b/g/n/ac/d/h/i/r/k/v/w/mc/ax, 2x2 MU-MIMO, BT5.2 & 2nd BLE, 8GB RAM/128GB Flash, N6803 FlexRange, 13MP Rear Camera / 8MP Front Camera, Fingerprint Sensor, Android (GMS), Device Client Pack (DCP) Pre-Loaded (1 Year DCP Term License), 1 x Nano SIM & 1 x eSIM, Standard, 4,775mAh Standard Battery, Global

CT47 Android - Wi-Fi Only - N6803 - 8GB RAM/ 128GB Flash

CT47-X0N-58D100G

CT47, WLAN, 5.5 inch Display, Wi-Fi 6E 802.11 a/b/g/n/ac/d/h/i/r/k/v/w/mc/ax, 2x2 MU-MIMO, BT5.2 & 2nd BLE, 8GB RAM/128GB Flash, N6803 FlexRange, 13MP Rear Camera / 8MP Front Camera, Fingerprint Sensor, Android (GMS), Device Client Pack (DCP) Pre-Loaded (1 Year DCP Term License), Standard, 4,775mAh Standard Battery, Global

CT47 Android - 5G WWAN - N6803 - 6GB RAM/ 128GB Flash

CT47-X1N-38D1EOG

CT47, 5G WWAN, 5.5 inch Display, Wi-Fi 6E 802.11 a/b/g/n/ac/d/h/i/r/k/v/w/mc/ax, 2x2 MU-MIMO, BT5.2 & 2nd BLE, 6GB RAM/128GB Flash, N6803 FlexRange, 13MP Rear Camera / 8MP Front Camera, Fingerprint Sensor, Android (GMS), Device Client Pack (DCP) Pre-Loaded (1 Year DCP Term License), 1 x Nano SIM & 1 x eSIM, Standard, 4,775mAh Standard Battery, Global

CT47 Android - Wi-Fi Only - N6803 - 6GB RAM/ 128GB Flash

CT47-X0N-38D100G

CT47, WLAN, 5.5 inch Display, Wi-Fi 6E 802.11 a/b/g/n/ac/d/h/i/r/k/v/w/mc/ax, 2x2 MU-MIMO, BT5.2 & 2nd BLE, 6GB RAM/128GB Flash, N6803 FlexRange, 13MP Rear Camera / 8MP Front Camera, Fingerprint Sensor, Android (GMS), Device Client Pack (DCP) Pre-Loaded (1 Year DCP Term License), Standard, 4,775mAh Standard Battery, Global

Honeywell Repair Services

SVCCT47-SG3N

CT47, Edge Service, Gold Maintenance Contract, 3 Year, New Contract

ADD SVCREPLACE-MOB3

AddOn, Edge Service, Device Replacement, Mobility, 3 Year

CT47 FEATURE OVERVIEW

S0803 FlexRange™ XLR Near/ Extra Long Range



Included in the box:

- CT47 Mobile Computer
- Battery (CT4X-BTSC-001)
- USB Type C cable
- Hand strap
- SIM/SD Card Cover Screw

(Stylus is NOT included, but available to order separately as an accessory)



S0803 FlexRange™ XLR



CT47 Android - 5G WWAN - S0803 - 8GB RAM/ 128GB Flash

CT47-X1N-5ED1EOG

CT47, 5G WWAN, 5.5 inch Display, Wi-Fi 6E 802.11 a/b/g/n/ac/d/h/i/r/k/v/w/mc/ax, 2x2 MU-MIMO, BT5.2 & 2nd BLE, 8GB RAM/128GB Flash, S0803 FlexRange XLR, 13MP Rear Camera / 8MP Front Camera, Fingerprint Sensor, Android (GMS), Device Client Pack (DCP) Pre-Loaded (1 Year DCP Term License), 1 x Nano SIM & 1 x eSIM, Standard, 4,775mAh Standard Battery, Global

CT47 Android - 5G WWAN - S0803 - 6GB RAM/ 128GB Flash

CT47-X1N-3ED1EOG

CT47, 5G WWAN, 5.5 inch Display, Wi-Fi 6E 802.11 a/b/g/n/ac/d/h/i/r/k/v/w/mc/ax, 2x2 MU-MIMO, BT5.2 & 2nd BLE, 6GB RAM/128GB Flash, S0803 FlexRange XLR, 13MP Rear Camera / 8MP Front Camera, Fingerprint Sensor, Android (GMS), Device Client Pack (DCP) Pre-Loaded (1 Year DCP Term License), 1 x Nano SIM & 1 x eSIM, Standard, 4,775mAh Standard Battery, Global

CT47 Android - Wi-Fi Only - S0803 - 8GB RAM/ 128GB Flash

CT47-X0N-5ED100G

CT47, WLAN, 5.5 inch Display, Wi-Fi 6E 802.11 a/b/g/n/ac/d/h/i/r/k/v/w/mc/ax, 2x2 MU-MIMO, BT5.2 & 2nd BLE, 8GB RAM/128GB Flash, S0803 FlexRange XLR, 13MP Rear Camera / 8MP Front Camera, Fingerprint Sensor, Android (GMS), Device Client Pack (DCP) Pre-Loaded (1 Year DCP Term License), Standard, 4,775mAh Standard Battery, Global

CT47 Android - Wi-Fi Only - S0803 - 6GB RAM/ 128GB Flash

CT47-X0N-3ED100G

CT47, WLAN, 5.5 inch Display, Wi-Fi 6E 802.11 a/b/g/n/ac/d/h/i/r/k/v/w/mc/ax, 2x2 MU-MIMO, BT5.2 & 2nd BLE, 6GB RAM/128GB Flash, S0803 FlexRange XLR, 13MP Rear Camera / 8MP Front Camera, Fingerprint Sensor, Android (GMS), Device Client Pack (DCP) Pre-Loaded (1 Year DCP Term License), Standard, 4,775mAh Standard Battery, Global

Honeywell Repair Services

SVCCT47-SG3N

CT47, Edge Service, Gold Maintenance Contract, 3 Year, New Contract

ADD SVCREPLACE-MOB3

AddOn, Edge Service, Device Replacement, Mobility, 3 Year

CT47 FEATURE OVERVIEW

Non-Incendive / ATEX / IEC Ex - S0803 FlexRange™ XLR Near/ Extra Long Range



Included in the box:

- CT47 Mobile Computer
- Battery (CT4X-BTSC-001)
- USB Type C cable
- Hand strap
- SIM/SD Card Cover Screw

(Stylus is NOT included, but available to order separately as an accessory)



S0803 FlexRange™ XLR



CT47 Android - 5G WWAN - S0803 - 8GB RAM/ 128GB Flash

CT47-X1N-5ED1E1G

CT47, 5G WWAN, 5.5 inch Display, Wi-Fi 6E 802.11 a/b/g/n/ac/d/h/i/r/k/v/w/mc/ax, 2x2 MU-MIMO, BT5.2 & 2nd BLE, 8GB RAM/128GB Flash, S0803 FlexRange XLR, 13MP Rear Camera / 8MP Front Camera, Fingerprint Sensor, Android (GMS), Device Client Pack (DCP) Pre-Loaded (1 Year DCP Term License), 1 x Nano SIM & 1 x eSIM, Non-Incendive (NI) / ATEX / IEC Ex, 4,775mAh NI/ATEX/IECEX Battery, Global

Honeywell Repair Services

SVCCT47-SG3N



CT47, Edge Service, Gold Maintenance Contract, 3 Year, New Contract

ADD SVCREPLACE-MOB3

AddOn, Edge Service, Device Replacement, Mobility, 3 Year

CT47 CONFIGURATION MAP

Android

	BLUETOOTH/WI-FI	WWAN	NFC	MEMORY	IMAGER	CAMERA	OPERATING SYSTEM	SIM	OPTIONS	DOMAIN	DESCRIPTION	NOTES
CT47-												
	X										Wi-Fi 6E 802.11 a/b/g/n/ac/mc/ax, 2x2 MU-MIMO + Bluetooth 5.2	IEEE 802.11 a/b/g/n/ac/d/h/i/r/k/v/w/mc/ax, 2x2 MU-MIMO ; Wi-Fi certified, Wi-Fi 6E certified Bluetooth V5.2 and BLE Supported Bluetooth Profiles: HFP, PBAP, A2DP, AVRCP, OPP, SPP, GATT
		0									No WWAN	
		1									5G, LTE (4G) GPS, UMTS/HSPA+ (3G) GSM/GPRS/EDGE	WWAN RADIO (ATT/VZW/SPRINT/TMO/NA/EU) 5G FR1 – BANDS 1,2,3,4,5,7,8,12,14,20,25,28,30,38,40,41,48,66,71,77,78,79 LTE – BANDS 1,2,3,4,5,7,8,12,13,14,17,18,19,20,25,26,28,29,30,32,38,39,40,41,42,43,66,71 UMTS/HSPA+ (3G) – BANDS 1, 2, 4, 5, 6, 8, 9, 19 / GSM/GPRS/EDGE QUAD-BAND (850/900/1800/1900 MHZ)
			N								Near Field Communications (NFC)	Integrated NFC reader, compliant with ISO/IEC 14443 A, ISO/IEC 14443 B, ISO/IEC 15693 (ICODE), MIFARE 1K / 4K, MIFARE DESFire, Sony FeliCa, ISO/IEC 18092 (Type F)
			--									
				3							6GB RAM, 128GB Flash Memory	Qualcomm QCS6490/QCM6490 octa-core, 2.7GHz
				5							8GB RAM, 128GB Flash Memory	Qualcomm QCS6490/QCM6490 octa-core, 2.7GHz
					7						1D/2D Imager (S0703SR) – Standard Range	
					8						1D/2D Imager (N6803FR) – FlexRange™	
					E						1D/2D Imager (S0803) – FlexRange™ XLR	
					D						13MP Rear Camera / 8MP Front Camera	
						1					Android (GMS)	Google Mobile Services (GMS) certified – Play Store
						2					Android (Non-GMS)	
						0					No SIM slot	
						E					1 x eSIM & 1 x Nano SIM Slot	
						0					Standard	
						1					Non-Incendive (NI) / ATEX / IEC Ex	
							G				Global (WWAN or Wi-Fi)	Algeria, Argentina, Australia, Austria, Belarus, Belgium, Bolivia, Brazil, Canada, Chile, Colombia, Costa Rica, Croatia, Czech Republic, Denmark, Dominican Republic, Ecuador, Egypt, Estonia, Finland, France, Germany, Greece, Guatemala, Hong Kong, Hungary, India, Ireland, Israel, Italy, Japan, Lithuania, Malaysia, Mexico, Morocco, Netherlands, New Zealand, Norway, Peru, Philippines, Poland, Portugal, Romania, Russian Fed., Saudi Arabia, Serbia, Singapore, Slovakia, Slovenia, South Africa, South Korea, Spain, Sweden, Switzerland, Taiwan, Thailand, Tunisia, Turkey, UAE, Ukraine, United Kingdom, United States of America



HONEYWELL EDGE SERVICES

CT47 – Repair Services

Honeywell Edge Services give you the confidence of having leading-class technologies combined with service and support plans that are designed to keep you operational for longer.

For a full description of maintenance services, including terms and conditions, please see <https://sps.honeywell.com/us/en/services/productivity/support-services/maintenance-services>

Gold Repair Services – 3 Year

The Edge Services Gold Support contract allows flexibility for you to select the right coverage for your organization, including 5-Day Depot Repairs and:

Service Overview

- Repair or replacement (at Honeywell discretion) for damaged components, wear and tear, accidental damage
- Flexibility to add any Add-On Service
- Android Service - includes Android OS Upgrades, Maintenance Releases and Security Patches

PART NUMBER	DESCRIPTION
SVCCT47-SG3N	CT47, Edge Service, GOLD Maintenance Contract, 5 Day Turnaround, 3 Year , New Contract

Add-On Accessory Replacement Service

Provides replacement chargers, docks, charging cables, or scan handles should they be damaged or stop working.

ADD SVCACC-MOB3	AddOn, Edge Service, Accessory Service , Mobility, 3 Year . Service covers docks, charger cradles, scan handles
------------------------	--

Add-On Battery Replacement Service

Provides replacement batteries as needed after a minimum of 18 months post-purchase.

ADD SVCBATTERY-MOB3	AddOn, Edge Service, Battery Service, Mobility, 3 Year , 1 Replacement Battery over life of contract
----------------------------	---

Add-On Device Replacement Service

Replacement devices should a device be damaged beyond repair.

ADD SVCREPLACE-MOB3	AddOn, Edge Service, Device Replacement, Mobility, 3 Year
----------------------------	--

Add-On Image Management Service

Ensures that when a device returns from being repaired, it has all the proper applications loaded back on the device.

ADD SVCIMAGEMGMT-MOB3	AddOn, Edge Service, Image Service, Mobility, 3 Year
------------------------------	---

Add-On Spare Management Service

Manages your spare pool.

ADD SVCSPAREMGMT-MOB3	AddOn, Edge Service, Advanced Exchange, Mobility, 3 Year . Customer owned spare pool, Minimum Purchase required, contact your local Honeywell Service Representative for more information.
------------------------------	---

Add-On 2-Day Turnaround Depot Upgrade

Upgrade your Gold Maintenance Contract from 5-Day to 2-Day turnaround at the repair depot.

ADD SVC2DAYDEPOT-MOB3	AddOn, Edge Service, 2-Day Depot Upgrade, 3-Year Agreement, Requires purchase of a 3 Year Gold Maintenance Contract.
------------------------------	---

Platinum Repair Services – 3 Year

The Edge Services Platinum Support contract offers 2-Day Depot Repairs or Spare Pool Management with 3 year contract that includes:

Service Overview

- Repair or replacement (at Honeywell discretion) for damaged components, wear and tear, accidental damage
- SVCREPLACE-MOB3 - Replacement devices should a device be damaged beyond repair
- SVCACC-MOB3 - Accessory replacement service
- SVCBATTERY-MOB3 - Battery replacement service
- SVCSPAREMGMT-MOB3 - Spare pool management (optional, minimum quantity required)
- Telephone-based technical support
- Android Service - includes Android OS Upgrades, Maintenance Releases and Security Patches

PART NUMBER	DESCRIPTION
SVCCT47-SP3N	CT47, Edge Service, PLATINUM, 2 Day Turnaround, 3 Year , New Contract



HONEYWELL EDGE SERVICES

CT47 – Repair Services

Honeywell Edge Services give you the confidence of having leading-class technologies combined with service and support plans that are designed to keep you operational for longer.

For a full description of maintenance services, including terms and conditions, please see <https://sps.honeywell.com/us/en/services/productivity/support-services/maintenance-services>

Gold Repair Services – 5 Year

The Edge Services Gold Support contract allows flexibility for you to select the right coverage for your organization, including 5-Day Depot Repairs and:

Service Overview

- Repair or replacement (at Honeywell discretion) for damaged components, wear and tear, accidental damage
- Flexibility to add any Add-On Service
- Android Service - includes Android OS Upgrades, Maintenance Releases and Security Patches

PART NUMBER	DESCRIPTION
SVCCT47-SG5N	CT47, Edge Service, GOLD Maintenance Contract, 5 Day Turnaround, 5 Year , New Contract

Add-On Accessory Replacement Service

Provides replacement chargers, docks, charging cables, or scan handles should they be damaged or stop working.

ADD SVCACC-MOB5	AddOn, Edge Service, Accessory Service , Mobility, 5 Year . Service covers docks, charger cradles, scan handles
------------------------	--

Add-On Battery Replacement Service

Provides replacement batteries as needed after a minimum of 18 months post-purchase.

ADD SVCBATTERY-MOB5	AddOn, Edge Service, Battery Service, Mobility, 5 Year , 2 Replacement Battery over life of contract
----------------------------	---

Add-On Device Replacement Service

Replacement devices should a device be damaged beyond repair.

ADD SVCREPLACE-MOB5	AddOn, Edge Service, Device Replacement, Mobility, 5 Year
----------------------------	--

Add-On Image Management Service

Ensures that when a device returns from being repaired, it has all the proper applications loaded back on the device.

ADD SVCIMAGEMGMT-MOB5	AddOn, Edge Service, Image Service, Mobility, 5 Year
------------------------------	---

Add-On Spare Management Service

Manages your spare pool.

ADD SVCSPAREMGMT-MOB5	AddOn, Edge Service, Advanced Exchange, Mobility, 5 Year . Customer owned spare pool, Minimum Purchase required, contact your local Honeywell Service Representative for more information.
------------------------------	---

Add-On 2-Day Turnaround Depot Upgrade

Upgrade your Gold Maintenance Contract from 5-Day to 2-Day turnaround at the repair depot.

ADD SVC2DAYDEPOT-MOB5	AddOn, Edge Service, 2-Day Depot Upgrade, 5-Year Agreement, Requires purchase of a 5 Year Gold Maintenance Contract.
------------------------------	---

Platinum Repair Services – 5 Year

The Edge Services Platinum Support contract offers 2-Day Depot Repairs or Spare Pool Management with 5 year contract that includes:

Service Overview

- Repair or replacement (at Honeywell discretion) for damaged components, wear and tear, accidental damage
- SVCREPLACE-MOB5 - Replacement devices should a device be damaged beyond repair
- SVCACC-MOB5 - Accessory replacement service
- SVCBATTERY-MOB5 - Battery replacement service
- SVCSPAREMGMT-MOB5 - Spare pool management (optional, minimum quantity required)
- Telephone-based technical support
- Android Service - includes Android OS Upgrades, Maintenance Releases and Security Patches

PART NUMBER	DESCRIPTION
SVCCT47-SP5N	CT47, Edge Service, PLATINUM, 2 Day Turnaround, 5 Year , New Contract



HONEYWELL REPAIR SERVICES

CT47 - Repair Services Coverage

Service options tailored to customer requirements



CT47

Warranty Cover Against Product Defect

BASIC Service

Gold Coverage:

- Accidental Damage
- Wear & Tear
- Android Service

Includes Replacement of:

- Handstrap
- Screen Protector



Flexible GOLD Add-Ons ordered separately

- SVCACC-MOB3 Accessories
- SVCBATTERY-MOB3 Batteries
- SVCREPLACE-MOB3 Device Replacement
- SVCIMAGEMGMT-MOB3 Image Service
- SVCSPAREMGMT-MOB3 Advanced Exchange

GOLD Service

Platinum Coverage

- Battery Replacement
- Coverage for Docks/ Chargers
- Android Service

- Accidental Damage
- Device Replacement
- Wear & Tear



Pistol Grip



Vehicle Dock



Car Chargers



Battery
(3 Year – 1 replacement battery per CT47)
(5 Year – 2 replacement batteries per CT47)



Docks



Dock Power Supplies

PLATINUM Service

COVERAGE	PART NUMBER	DESCRIPTION
BASIC	SVCCT47-EXW2	CT47, BASIC, 10-15 Day Turnaround, 2 Years (1 Year Factory Warranty + 1 Year Extended)
GOLD	SVCCT47-SG3N	CT47, Edge Service, GOLD Maintenance Contract, 5 Day Turnaround, 3 Year, New Contract
ADD	SVCACC-MOB3	AddOn, Edge Service, Accessory Service, Mobility, 3 Year. Service covers docks, charger cradles, scan handles and car adapter
ADD	SVCBATTERY-MOB3	AddOn, Edge Service, Battery Service, Mobility, 3 Year, 1 Replacement Battery over life of contract
ADD	SVCREPLACE-MOB3	AddOn, Edge Service, Device Replacement, Mobility, 3 Year
ADD	SVCIMAGEMGMT-MOB3	AddOn, Edge Service, Image Service, Mobility, 3 Year
ADD	SVCSPAREMGMT-MOB3	AddOn, Edge Service, Advanced Exchange, Mobility, 3 Year. Customer owned spare pool, Minimum Purchase required.
PLATINUM	SVCCT47-SP3N	CT47, Edge Service, PLATINUM, 2 Day Turnaround, 3 Year, New Contract

CT47 SOFTWARE

Device Client Pack

The Device Client Pack (DCP) includes Launcher, Enterprise Browser, BasicTE, and Mobility Web SDK, these applications are pre-loaded on the device.

All CT47 units include a 1 Year DCP Termed Pre-License for initial evaluation of the DCP applications (it does NOT include a Perpetual Pre-License), after the 1 Year Term period expires, a Perpetual or Term license is required to be purchased.

There are two licensing options that can be purchased for DCP:

1. Perpetual License Purchase DCP-001 - Perpetual Licenses operate without expiration for the authorized software version features, and includes 1 year of Maintenance. Add additional Software Maintenance separately.
2. Term + Maintenance License Purchase DCP-SFT1, DCP-SFT2, DCP-SFT3, DCP-SFT4 or DCP-SFT5 - Term + Maintenance Licenses provide software operation, software new version features, and tech support, all for a defined period.

Device Client Pack



Launcher



Launcher - gives the customer total control over which apps can be run on the device.



BasicTE



BasicTE Android device Terminal Emulation is a simplified alternative for those not yet ready to upgrade to SmartTE.



Enterprise Browser



Enterprise Browser provides corporations the ability to run standard web applications from a controlled environment.

Order Separately



SmartTE Terminal Emulator



Terminal Emulator - Full featured SmartTE allows legacy green screen apps to be transformed to the look and feel of native apps. These clients are single session Honeywell TE Licensing. They can also utilize traditional single or multi-session StayLinked Licenses.

SmartTE is Pre-Loaded, but requires license SMARTTE-001 to be purchased separately.

PART NUMBER	DESCRIPTION
SMARTTE-001	SmartTE Single path initial license. Includes 1 Year maintenance.
SMARTTE-SFT3	SMARTTE - 3 Year Software Maintenance
SMARTTE-SFT5	SMARTTE - 5 Year Software Maintenance
SMARTTE-SND-SFT1	SMARTTE - High availability secondary backup or development server, includes 1 Year maintenance. Not for primary server. Purchase one per device.

PART NUMBER	DESCRIPTION
DCP-001	Device Client Pack Perpetual License (DCP) includes 1 Year Software Maintenance. License covers Launcher, Enterprise Browser, BasicTE, and Mobility Web SDK. Purchase additional years of Software Maintenance DCP-SFT1, DCP-SFT2, DCP-SFT3, DCP-SFT4 or DCP-SFT5 prior to maintenance expiring. Perpetual license provides continuous access to the software, but includes only one year of maintenance for updates and patches
DCP-SFT1	Device Client Pack - 1 Year Term + Maintenance (License covers Launcher, Enterprise Browser, BasicTE, and Mobility Web SDK)
DCP-SFT2	Device Client Pack - 2 Year Term + Maintenance (License covers Launcher, Enterprise Browser, BasicTE, and Mobility Web SDK)
DCP-SFT3	Device Client Pack - 3 Year Term + Maintenance (License covers Launcher, Enterprise Browser, BasicTE, and Mobility Web SDK)
DCP-SFT4	Device Client Pack - 4 Year Term + Maintenance (License covers Launcher, Enterprise Browser, BasicTE, and Mobility Web SDK)
DCP-SFT5	Device Client Pack - 5 Year Term + Maintenance (License covers Launcher, Enterprise Browser, BasicTE, and Mobility Web SDK)

CT47 SCANNING

Scan Handle Side by Side Comparison

Use for Scan intensive applications.



	PART NUMBER	DESCRIPTION
1	CT45-SH-UVN	CT45 and CT45 XP universal scan handle to be used with CT45/XP without Protective Boot
2	CT47-SH-UVB	CT47 universal scan handle to be used with CT47 with Protective Boot (includes CT47-PB-1)

CT47 SCANNING

Option 1 - Scan Handle

Use for Scan intensive applications, also compatible with using Rear Camera with Scan Handle installed.

This scan handle is ONLY compatible with Non-Booted charging docks.



Stylus



Side View



Rear View

PART NUMBER	DESCRIPTION
1	<p>CT45, CT45 XP and CT47 universal scan handle to be used with CT45/CT45 XP/ CT47 without protective boot Compatible for use with Home Base and Charge Base without removal.</p> <p>CT45-SH-UVN</p>
	<p>CT40-HB-0 / CT40-HB-UVN-0 Home Base CT40-CB-CNV-0 / CT40-CB-UVN-0 Quad Charge Base CT40-EB-0 / CT40-EB-UVN-0 Ethernet Home Base CT40-NB-CNV-0 / CT40-NB-UVN-0 Quad Net Base CT40-DB-0 / CT40-DB-UVN-0 Display Base</p> <p>Not Compatible with the Protective Boot Bases</p> <p>CT40-HB-UVB-0 Protective Boot Home Base CT40-EB-UVB-0 Protective Boot Ethernet Home Base CT40-DB-UVB-0 Protective Boot Display Base CT40-CB-PB-0 Protective Boot Quad Charge Base CT40-CB-UVB-0 Protective Boot Quad Charge Base CT40-NB-PB-0 Protective Boot Quad Net Base CT40-NB-UVB-0 Protective Boot Quad Net Base</p>

CT47 SCANNING

Option 2 - Scan Handle with Protective Boot

Use for Scan intensive applications with additional protection of the protective boot.
 This scan handle is ONLY compatible with Booted charging docks.



Stylus



Side View



Rear View

PART NUMBER	DESCRIPTION												
1	CT47-SH-UVB	CT47 universal scan handle to be used with CT47 with Protective Boot (includes CT47-PB-1) Compatible for use with Protective Boot Home Base and Charge Base without removal.											
	CT40-HB-UVB-0	Protective Boot Home Base											
	CT40-EB-UVB-0	Protective Boot Ethernet Home Base											
	CT40-DB-UVB-0	Protective Boot Display Base											
	CT40-CB-PB-0	Protective Boot Quad Charge Base											
	CT40-NB-PB-0	Protective Boot Quad Net Base											
	<table border="0"> <tr> <td>CT40-CB-UVB-0</td> <td>Protective Boot Quad Charge Base</td> </tr> <tr> <td>CT40-NB-UVB-0</td> <td>Protective Boot Quad Net Base</td> </tr> </table>	CT40-CB-UVB-0	Protective Boot Quad Charge Base	CT40-NB-UVB-0	Protective Boot Quad Net Base								
CT40-CB-UVB-0	Protective Boot Quad Charge Base												
CT40-NB-UVB-0	Protective Boot Quad Net Base												
	<p>Not Compatible with the Non-Protective Boot Bases</p> <table border="0"> <tr> <td>CT40-HB-0 / CT40-HB-UVN-0</td> <td>Home Base</td> <td>CT40-CB-CNV-0 / CT40-CB-UVN-0</td> <td>Quad Charge Base</td> </tr> <tr> <td>CT40-EB-0 / CT40-EB-UVN-0</td> <td>Ethernet Home Base</td> <td>CT40-NB-CNV-0 / CT40-NB-UVN-0</td> <td>Quad Net Base</td> </tr> <tr> <td>CT40-DB-0 / CT40-DB-UVN-0</td> <td>Display Base</td> <td></td> <td></td> </tr> </table>	CT40-HB-0 / CT40-HB-UVN-0	Home Base	CT40-CB-CNV-0 / CT40-CB-UVN-0	Quad Charge Base	CT40-EB-0 / CT40-EB-UVN-0	Ethernet Home Base	CT40-NB-CNV-0 / CT40-NB-UVN-0	Quad Net Base	CT40-DB-0 / CT40-DB-UVN-0	Display Base		
CT40-HB-0 / CT40-HB-UVN-0	Home Base	CT40-CB-CNV-0 / CT40-CB-UVN-0	Quad Charge Base										
CT40-EB-0 / CT40-EB-UVN-0	Ethernet Home Base	CT40-NB-CNV-0 / CT40-NB-UVN-0	Quad Net Base										
CT40-DB-0 / CT40-DB-UVN-0	Display Base												

CT47 PROTECTIVE BOOT

Dockable Protective Boot

Use when protective boot is required with or without scan handle and dockable, compatible with handstrap installed.



PART NUMBER	DESCRIPTION
1 CT47-PB-1	CT47 Protective Boot

CT47 DESKTOP COMMUNICATIONS

Option 1 – Portable – Non-Booted or Booted

USB Communication to PC/ Mac OR Snap-On Charging.



PART NUMBER	DESCRIPTION
1 CT45-SN-CNV	CT45/CT45XP/CT47 Booted and Non-Booted Snap On adaptor. Provides tethered USB client connectivity. Compatible with hand strap, battery pack, and scan handle. Charges mobile computer battery in four hours or less. Kit includes snap-on adapter with convertible adaptor (CT45-SN-IST).
2 50136024-001	KIT,5V/2A PS,5 PLUGS PACKED, ROW Includes US,UK,AU,EU,IN adapters

Option 2 – Fixed with Universal Cup

USB and optional Ethernet Communication & Single Battery Charger.



CT40-HB-UVN-0 Home Base CT40-EB-UVN-0 eHome Base
CT40-HB-UVB-0 Home Base CT40-EB-UVB-0 eHome Base



Rear View

PART NUMBER	DESCRIPTION
1A CT40-HB-UVN-0	Non-Booted HomeBase - Kit includes (CT40-UCP-N), Dock & Power Supply, No Power Cord
OR CT40-EB-UVN-0	Non-Booted eHomeBase – Ethernet Kit includes (CT40-UCP-N), Dock & Power Supply, No Power Cord
1B CT40-HB-UVB-0	Booted HomeBase - Kit includes (CT40-UCP-B), Dock & Power Supply, No Power Cord
OR CT40-EB-UVB-0	Booted eHomeBase – Ethernet Kit includes (CT40-UCP-B), Dock & Power Supply, No Power Cord
2 321-576-004	Cable Assembly - USB Type A to Type B
3 **	IEC C13 AC Power Cord – See Page 44 for Country Specific Power Cords

CT47 COMMUNICATIONS

Option 3 – USB Type C On-The-Go (OTG) Desktop

USB C Communication to PC/ Mac OR Charging.

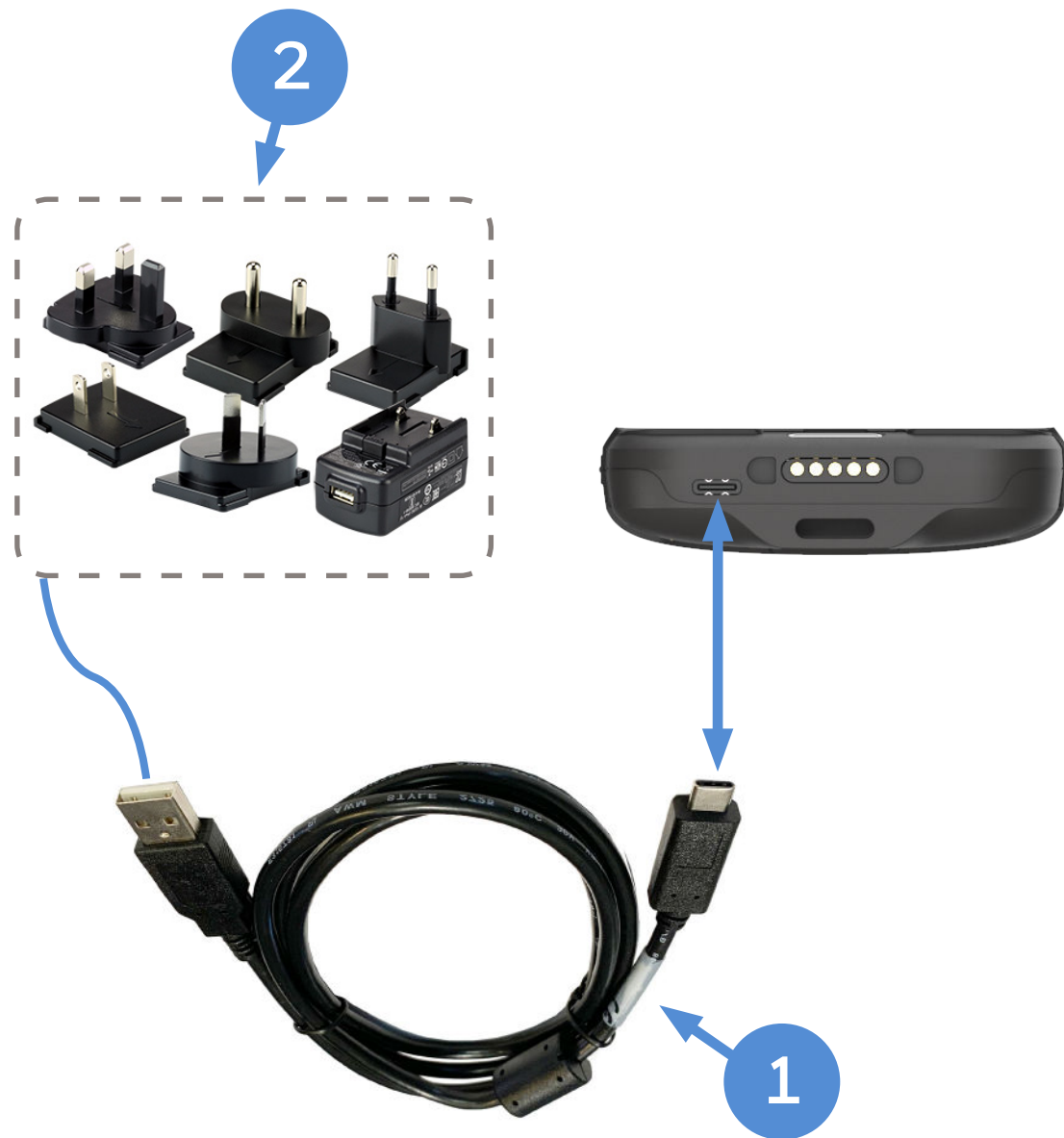

PART NUMBER	DESCRIPTION
1	CBL-500-120-S00-05 USB type A to type C, 1.2 m (3.9 ft)
2	50136024-001 KIT,5V/2A PS,5 PLUGS PACKED, ROW Includes US,UK,AU,EU,IN adapters

Option 4 – USB Type C On-The-Go (OTG) Vehicle

USB C Communication to Vehicle OR Charging.



PART NUMBER	DESCRIPTION
1A	CBL-500-120-S00-05 USB type A to type C, 1.2 m (3.9 ft)
1B	CT45 and CT45XP Booted and Non-Booted Snap On adaptor. Provides tethered USB client connectivity. Compatible with hand strap, battery pack, and scan handle. Charges mobile computer battery in four hours or less. Kit includes snap-on adaptor with convertible adaptor (CT45-SN-IST).
2	CT45-CIGR-1 Charging CT45, CT45XP, CT40 and CT40XP configurations on vehicle. Quick Charge 3.0 compliant. Requires CT45 USB adapter (CT45-SN-CNV) or USB cable (CBL-500-120-S00-05) to be ordered separately. (Converts 12 V/24 V cigarette lighter port to USB type-A power adapter for snap-on use in a vehicle)

CT47 DESKTOP COMMUNICATIONS

Option 5 - Display Base with Universal Cup

Connect USB peripherals (keyboard, mouse) and External Monitor via HDMI.



PART NUMBER	DESCRIPTION
1A CT40-DB-UVN-0	Non-Booted Display Dock - Kit includes (CT40-UCP-N), Display Base & Power Supply, No Power Cord
1B CT40-DB-UVB-0	Booted Display Dock - Kit includes (CT40-UCP-B), Display Base & Power Supply, No Power Cord
2 **	IEC C13 AC Power Cord – See Page 44 for Country Specific Power Cords

CT47 VEHICLE INSTALL

Option 1 – Portable/ Sub Contractor Install

Simple Vehicle Charging, portable between vehicles.

Compatible with CT47 with or without CT47-PB-1 Protective Boot installed.



PART NUMBER **DESCRIPTION**

1	CT45-SN-CNV	CT45/CT45XP/CT47 Booted and Non-Booted Snap On adaptor. Provides tethered USB client connectivity. Compatible with hand strap, battery pack, and scan handle. Charges mobile computer battery in four hours or less. Kit includes snap-on adapter with convertible adaptor (CT45-SN-IST).
2	CT45-CIGR-1	Charging CT45, CT45XP, CT40 and CT40XP configurations on vehicle. Quick Charge 3.0 compliant. Requires CT45 USB adapter (CT45-SN-CNV) or USB cable (CBL-500-120-S00-05) to be ordered separately. (Converts 12 V/24 V cigarette lighter port to USB type-A power adapter for snap-on use in a vehicle)

Option 2 – Portable/ Sub Contractor Install

Windscreen Suction Cup Mount, portable between vehicles.

Compatible with CT47 with or without CT47-PB-1 Protective Boot installed.



Recommended Screws
8#-32-UNC
(Length = 0.5 inch)
50143775-001 Pack 4 Screws

PART NUMBER **DESCRIPTION**

1	CT45-VD-CNV	CT45/ CT45 XP/ CT47 Booted and Non-Booted Vehicle Dock. For charging CT45/XP with or without a convertible adaptor, compatible with hand strap. NFC tag integrated for seamless pairing with mobile computer. Kit includes vehicle dock (CT40-VD-CNV) with convertible adaptor (CT45-VD-IST).
2	RAM-B-166-202U	Suction Cup Mount Kit
3	50138169-001	Cigarette Lighter Power Adapter Cable

CT47 VEHICLE INSTALL

Option 3 - Fixed Vehicle Install with Direct Connection to Vehicle Battery

Best used when the vehicle input voltage varies, 10- 30V.

Compatible with CT47 with or without CT47-PB-1 Protective Boot installed.



PART NUMBER	DESCRIPTION
1 CT45-VD-CNV	CT45/ CT45 XP/ CT47 Booted and Non-Booted Vehicle Dock. For charging CT45/XP with or without a convertible adaptor, compatible with hand strap. NFC tag integrated for seamless pairing with mobile computer. Kit includes vehicle dock (CT40-VD-CNV) with convertible adaptor (CT45-VD-IST).
2 203-802-001	Vehicle Dock Installation Kit (Power Option: For connection of Vehicle Dock directly to vehicle battery. Includes power cables and cable mounting hardware)
3 805-611-001	Mounting Kit, V-Dock RoHS

CT47 VEHICLE INSTALL

Option 4 - Fixed Vehicle Install with Direct Connection to Vehicle Battery - External Speaker

Best used when the vehicle input voltage varies, 10- 30V.

Compatible with CT47 with or without CT47-PB-1 Protective Boot installed.

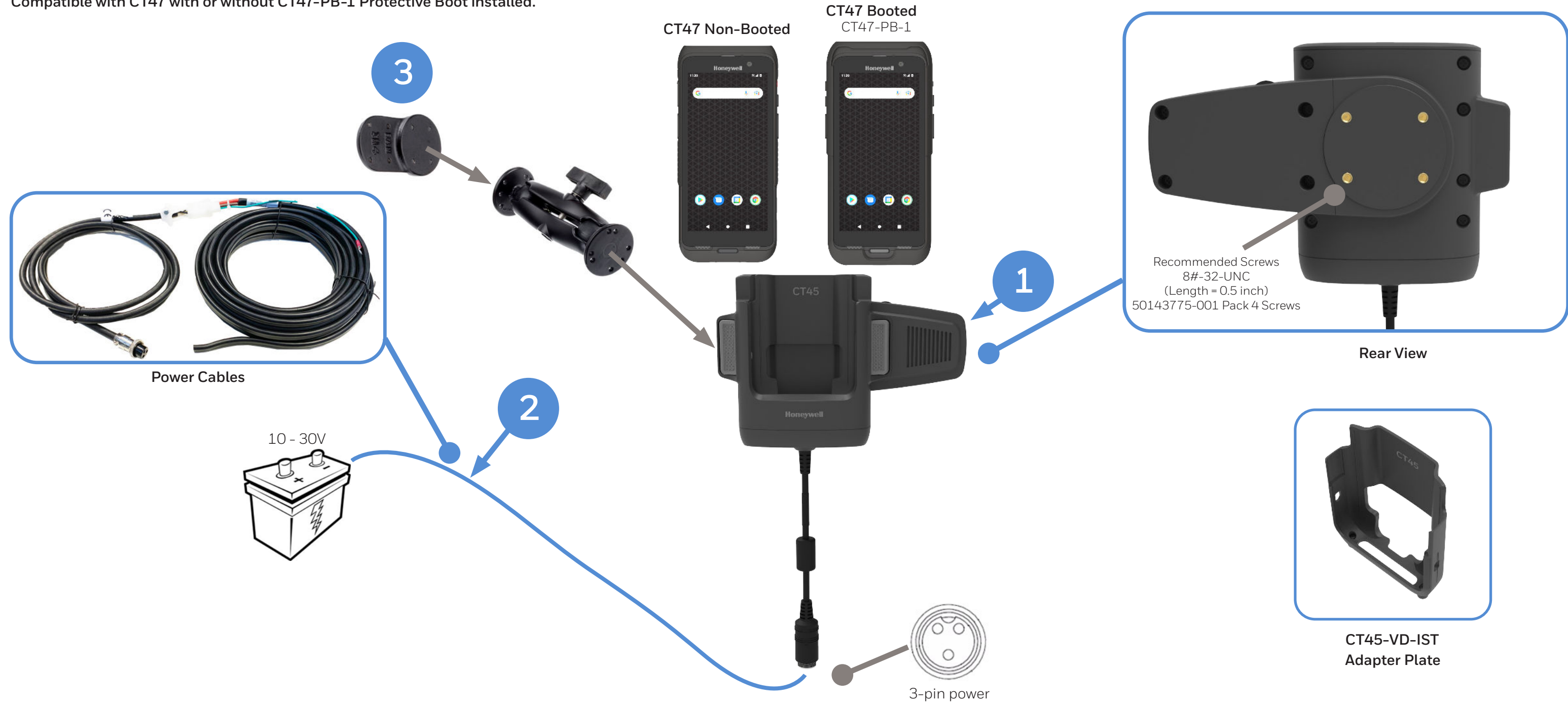

PART NUMBER	DESCRIPTION
1 CT45-VD-CNV-SPK	CT45/ CT45 XP/ CT47 Booted and Non-Booted Vehicle Dock with External Speaker. For charging CT45/XP with or without a convertible adaptor, compatible with hand strap. NFC tag integrated for seamless pairing with mobile computer. Kit includes vehicle dock with convertible adaptor (CT45-VD-IST).
2 203-802-001	Vehicle Dock Installation Kit (Power Option: For connection of Vehicle Dock directly to vehicle battery. Includes power cables and cable mounting hardware)
3 805-611-001	Mounting Kit, V-Dock RoHS

CT47 VEHICLE INSTALL

Option 5 - Fixed Vehicle Install with Direct Connection to Vehicle Battery/ Fuse Block

Best used when the vehicle input voltage varies, 10- 30V.

Compatible with CT47 with or without CT47-PB-1 Protective Boot installed.



	PART NUMBER	DESCRIPTION
1	CT45-VD-CNV	CT45/ CT45 XP/ CT47 Booted and Non-Booted Vehicle Dock. For charging CT45/XP with or without a convertible adaptor, compatible with hand strap. NFC tag integrated for seamless pairing with mobile computer. Kit includes vehicle dock (CT40-VD-CNV) with convertible adaptor (CT45-VD-IST).
2	226-109-003	72" (182.88 cm) Fuse block Power Cable with spade lugs and 3-pin connector
OR	226-109-004	22" (55.8 cm) Fuse block Power Cable with spade lugs and 3-pin connector
3	805-611-001	Mounting Kit, V-Dock RoHS
OPTIONAL	203-803-001	Vehicle Dock Fuse Block Power Kit RoHS (Provides connection to vehicle fuse block). Requires Power Cable (226-109-003 or 226-109-004).

CT47 VEHICLE INSTALL

Option 6 - Fixed Vehicle Install with Direct Connection to Vehicle Battery/ Fuse Block - External Speaker

Best used when the vehicle input voltage varies, 10- 30V.

Compatible with CT47 with or without CT47-PB-1 Protective Boot installed.

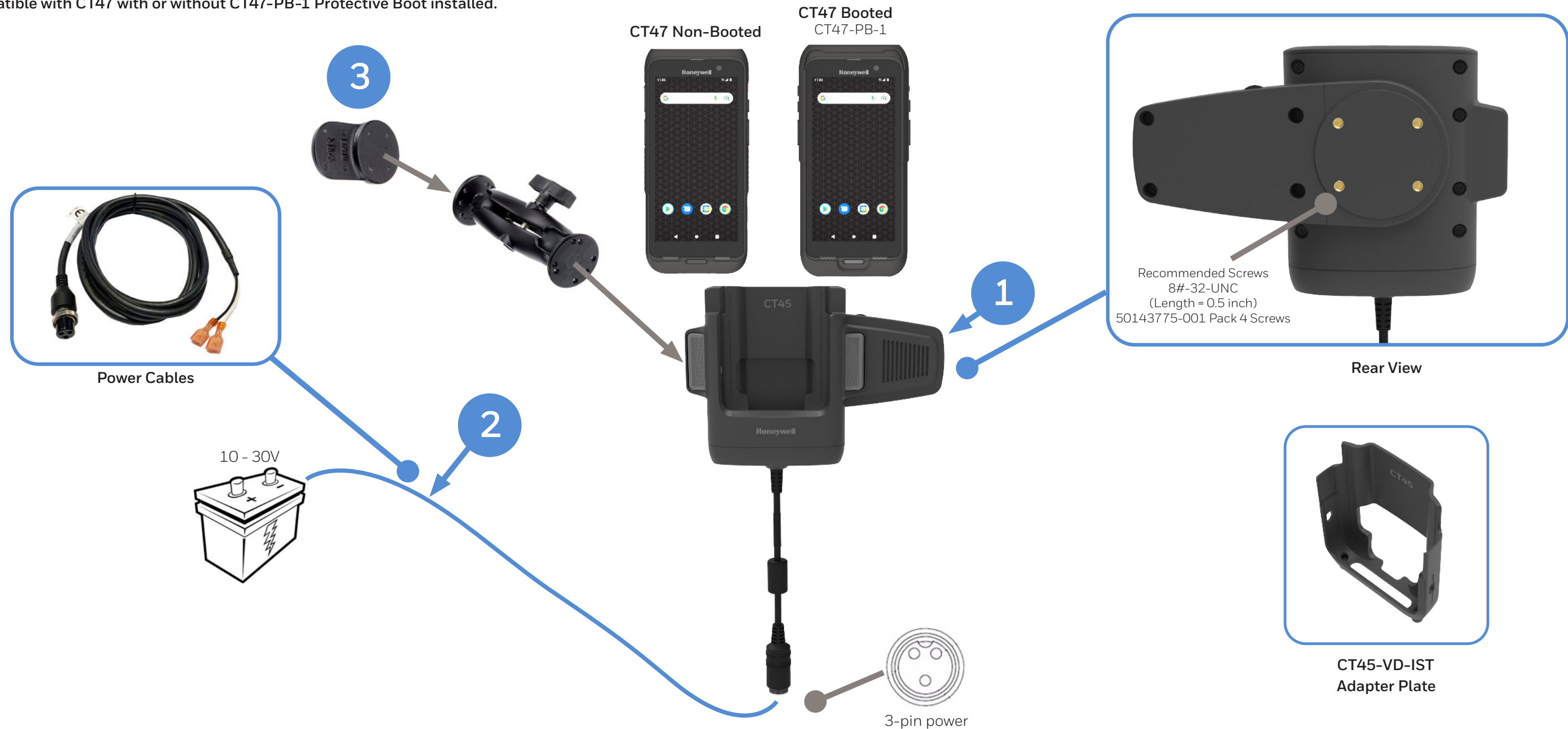

	PART NUMBER	DESCRIPTION
1	CT45-VD-CNV-SPK	CT45/ CT45 XP/ CT47 Booted and Non-Booted Vehicle Dock with External Speaker. For charging CT45/XP with or without a convertible adaptor, compatible with hand strap. NFC tag integrated for seamless pairing with mobile computer. Kit includes vehicle dock with convertible adaptor (CT45-VD-IST).
2	226-109-003	72" (182.88 cm) Fuse block Power Cable with spade lugs and 3-pin connector
OR	226-109-004	22" (55.8 cm) Fuse block Power Cable with spade lugs and 3-pin connector
3	805-611-001	Mounting Kit, V-Dock RoHS
OPTIONAL	203-803-001	Vehicle Dock Fuse Block Power Kit RoHS (Provides connection to vehicle fuse block). Requires Power Cable (226-109-003 or 226-109-004).

CT47 VEHICLE INSTALL

Option 7 - Fixed Vehicle Install with Thor DC/DC Converter

Best used when the vehicle input voltage varies, 9-60V or 50-150V.
Compatible with CT47 with or without CT47-PB-1 Protective Boot installed.

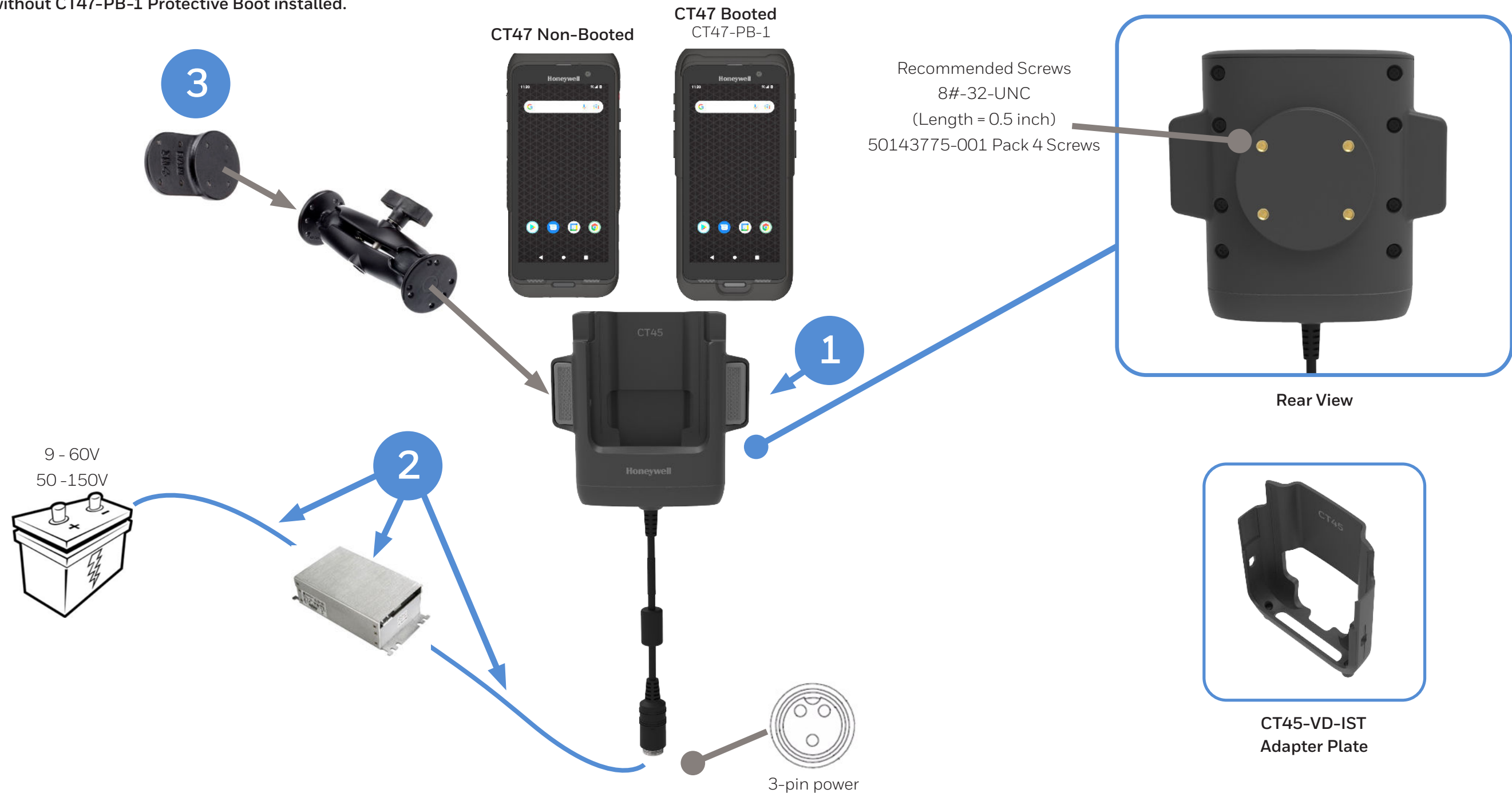

PART NUMBER	DESCRIPTION
1	CT45-VD-CNV CT45/ CT45 XP/ CT47 Booted and Non-Booted Vehicle Dock. For charging CT45/XP with or without a convertible adaptor, compatible with hand strap. NFC tag integrated for seamless pairing with mobile computer. Kit includes vehicle dock (CT40-VD-CNV) with convertible adaptor (CT45-VD-IST).
2	9000311PWRSPLY DC/DC Converter Kit, 9-60V DC, RoHS (Requires 226-109-003 Wiring Harness)
OR	9000313PWRSPLY DC/DC Converter Kit, 50-150V DC RoHS (Requires 226-109-003 Wiring Harness)
	226-109-003 72" (182.88 cm) Fuse block Power Cable with spade lugs and 3-pin connector
3	805-611-001 Mounting Kit, V-Dock RoHS

CT47 VEHICLE INSTALL

Option 8 - Fixed Vehicle Install with Thor DC/DC Converter - External Speaker

Best used when the vehicle input voltage varies, 9-60V or 50-150V.
Compatible with CT47 with or without CT47-PB-1 Protective Boot installed.

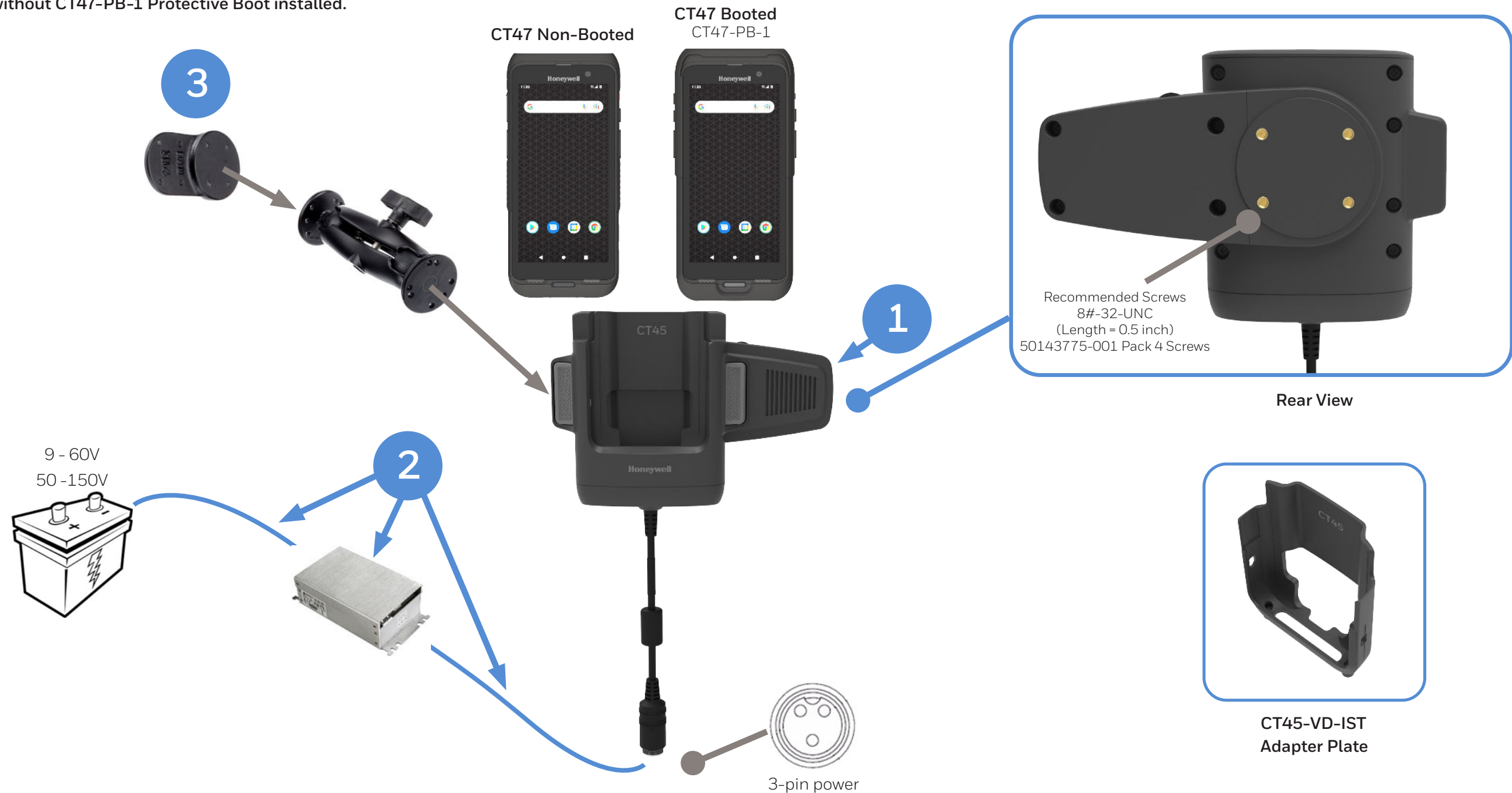

PART NUMBER	DESCRIPTION
1 CT45-VD-CNV-SPK	CT45/ CT45 XP/ CT47 Booted and Non-Booted Vehicle Dock with External Speaker. For charging CT45/XP with or without a convertible adaptor, compatible with hand strap. NFC tag integrated for seamless pairing with mobile computer. Kit includes vehicle dock with convertible adaptor (CT45-VD-IST).
2 9000311PWRSPLY	DC/DC Converter Kit, 9-60V DC, RoHS (Requires 226-109-003 Wiring Harness)
OR 9000313PWRSPLY	DC/DC Converter Kit, 50-150V DC RoHS (Requires 226-109-003 Wiring Harness)
226-109-003	72" (182.88 cm) Fuse block Power Cable with spade lugs and 3-pin connector
3 805-611-001	Mounting Kit, V-Dock RoHS

CT47 VEHICLE INSTALL

CT45/ CT47 Vehicle Dock (CT45-VD-CNV) Detail View - Non-Booted

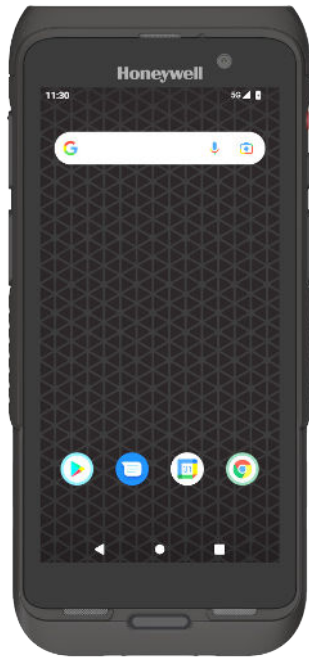

Insert
CT45-VD-IST



Angle View
Connector Detail



Angle View
CT4X Non-Booted

Front View

Rear View

CT47 VEHICLE INSTALL

CT45/ CT47 Vehicle Dock (CT45-VD-CNV) Detail View - Booted



Front View



Rear View



Protective Boot
CT47-PB-1



Angle View
Connector Detail



Angle View
CT4X Booted

CT47 VEHICLE INSTALL

CT45/ CT47 Vehicle Dock with External Speaker (CT45-VD-CNV-SPK) Detail View - Non-Booted



Insert
CT45-VD-IST



Angle View
Connector Detail



Angle View
CT4X Non-Booted

Front View

Rear View

CT47 VEHICLE INSTALL

CT45/ CT47 Vehicle Dock with External Speaker (CT45-VD-CNV-SPK) Detail View – Booted



Protective Boot
CT47-PB-1

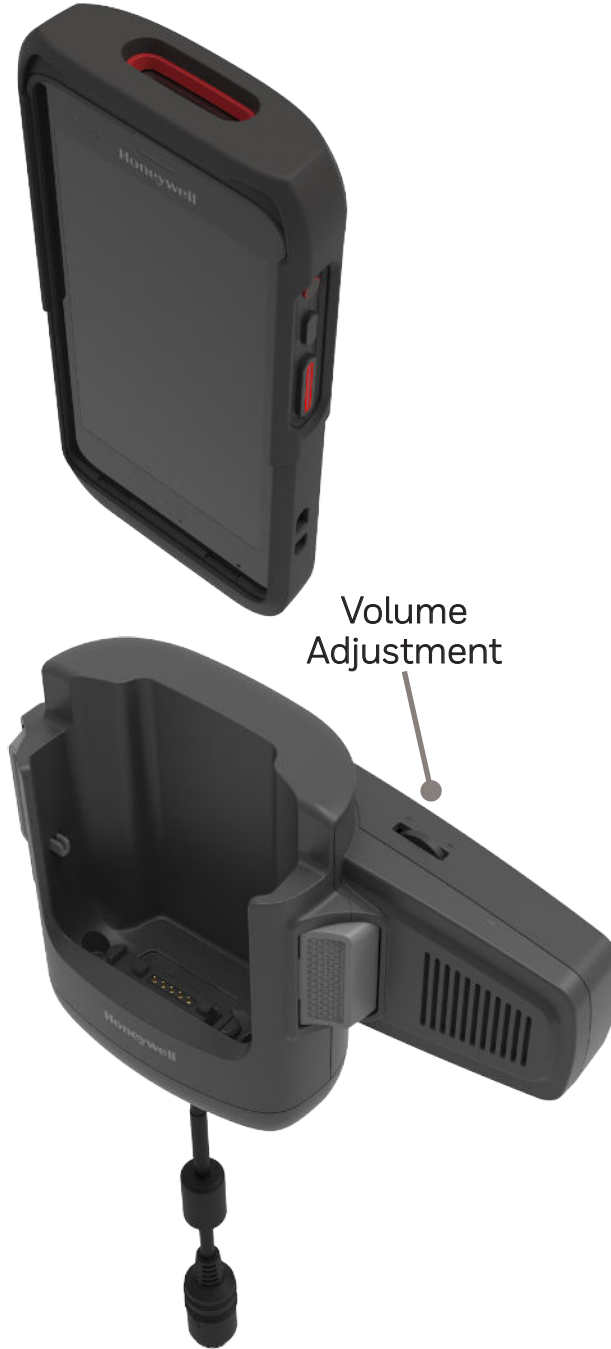

Volume Adjustment

Angle View
Connector Detail



Angle View
CT4X Booted

Front View

Rear View

CT47 CHARGING AND COMMUNICATION

Option 1 - Non-Booted Quad Charger with Universal Cup

Chargebase – Quad Dock Charge Only
 Netbase – Quad Dock with Ethernet
 Not Compatible with CT47-PB-1 Protective Boot



Kit Includes:
 4 x CT40-UCP-N
 CT40 / CT45 / CT47 Cup for Non-Booted

Option 2 - Booted Quad Charger with Universal Cup

Chargebase – Quad Dock Charge Only
 Netbase – Quad Dock with Ethernet
 Compatible with CT47-PB-1 Protective Boot



Kit Includes:
 4 x CT40-UCP-B
 CT40 / CT45 / CT47 Cup for Booted

	PART NUMBER	DESCRIPTION
1	CT40-CB-UVN-0	Non-Booted Chargebase - Kit includes Dock and Power Supply
OR	CT40-NB-UVN-0	Non-Booted Netbase - For Ethernet comms, Kit includes Dock and Power Supply
2	**	IEC C13 AC Power Cord – See Page 44 for Country Specific Power Cords

	PART NUMBER	DESCRIPTION
1	CT40-CB-UVB-0	Booted Chargebase - Kit includes Dock and Power Supply
OR	CT40-NB-UVB-0	Booted Netbase - For Ethernet comms, Kit includes Dock and Power Supply
2	**	IEC C13 AC Power Cord – See Page 44 for Country Specific Power Cords

CT47 CHARGING AND COMMUNICATION

Option 3 - Non-Booted 5-Bay Charger with Battery Cup

Chargebase – Quad Dock Charge Only (4 terminals) and Quad Battery Charger (4 Batteries)

Not Compatible with CT47-PB-1 Protective Boot

Compatible with Scan Handle



Top View with Scan Handle installed



Kit Includes:
4 x CT40-UCP-N
CT40 / CT45 / CT47 Cup for Non-Booted

Option 4 - Booted 5-Bay Charger with Battery Cup

Chargebase – Quad Dock Charge Only (4 terminals) and Quad Battery Charger (4 Batteries)

Compatible with CT47-PB-1 Protective Boot

Compatible with Scan Handle



Top View with Scan Handle installed



Kit Includes:
4 x CT40-UCP-B
CT40 / CT45 / CT47 Cup for Booted

PART NUMBER	DESCRIPTION
1	CT45 Non-Booted 5 bay Universal Dock, charge up to 4 pieces of CT45/CT40/CT45XP/CT40XP/CT47 and 4 pieces of CT4x batteries. Kit includes 5 bay Universal Dock and Power Adaptor. IEC C5 Power cord must be ordered separately.
2	** IEC C5 AC Power Cord – See Page 44 for Country Specific Power Cords

PART NUMBER	DESCRIPTION
1	CT45 Booted 5 bay Universal Dock, charge up to 4 pieces of CT45/CT40/CT45XP/CT40XP/CT47 and 4 pieces of CT4x batteries. Kit includes 5 bay Universal Dock and Power Adaptor. IEC C5 Power cord must be ordered separately.
2	** IEC C5 AC Power Cord – See Page 44 for Country Specific Power Cords

CT47 CHARGING AND COMMUNICATION

Option 5 - Non-Booted 5-Bay Charger with Universal Cups

Chargebase – 5-Bay Dock Charge Only (5 terminals)
 Not Compatible with CT47-PB-1 Protective Boot
 Compatible with Scan Handle



Top View with Scan Handle installed



Kit Includes:
 4 x CT40-UCP-N
 CT40 / CT45 / CT47 Cup for Non-Booted

Option 6 - Booted 5-Bay Charger with Universal Cups

Chargebase – 5-Bay Dock Charge Only (5 terminals)
 Compatible with CT47-PB-1 Protective Boot
 Compatible with Scan Handle



Top View with Scan Handle installed



Kit Includes:
 4 x CT40-UCP-B
 CT40 / CT45 / CT47 Cup for Booted

PART NUMBER DESCRIPTION

1	CT45-5CB-UVN-0	CT45 Non-Booted 5 bay Universal Dock, charge up to 5 pieces of CT45/CT40/CT45XP/CT40XP or CT47. Kit includes 5 bay Universal Dock and Power Adaptor. IEC C5 Power cord must be ordered separately.
2	**	IEC C5 AC Power Cord – See Page 44 for Country Specific Power Cords

PART NUMBER DESCRIPTION

1	CT45-5CB-UVB-0	CT45 Booted 5 bay Universal Dock, charge up to 5 pieces of CT45/CT40/CT45XP/CT40XP or CT47.. Kit includes 5 bay Universal Dock and Power Adaptor. IEC C5 Power cord must be ordered separately.
2	**	IEC C5 AC Power Cord – See Page 44 for Country Specific Power Cords

CT47 CHARGING AND COMMUNICATION

Option 7 - Quad Battery Charger

Charge up to 4 batteries simultaneously

- Supports Batteries:
- 318-055-010 - Battery, Standard, CT40 Gen 1 (4090mAh)
 - 318-055-011 - Battery, Standard, CT40 Gen 1 (4040mAh)
 - 318-055-014 - Battery, Standard, CT40 Gen 2 (4090mAh)
 - 318-055-015 - Battery, Standard, CT40 Gen 2 (4020mAh)
 - 318-055-017 - Battery, Standard, CT40 Healthcare (4020mAh)
 - 318-055-067 - Battery, Standard, CT40 Gen 2 / XP, CT45 / XP (4020mAh)
 - 318-055-D67 - Battery, Standard, CT40 DRH / XP (4020mAh)
 - 318-055-H67 - Battery, Standard, CT40 Healthcare / XP (4020mAh)
 - CT4X-BTSC-001 - Battery, Standard, CT45 / CT47, 4775mAh
 - CT4X-BTWC-001 - Battery, Wireless, CT45 / CT47, 4680mAh
 - CT4X-BTSC-002 - Battery, NI / ATEX / IEC Ex, CT47, 4775mAh

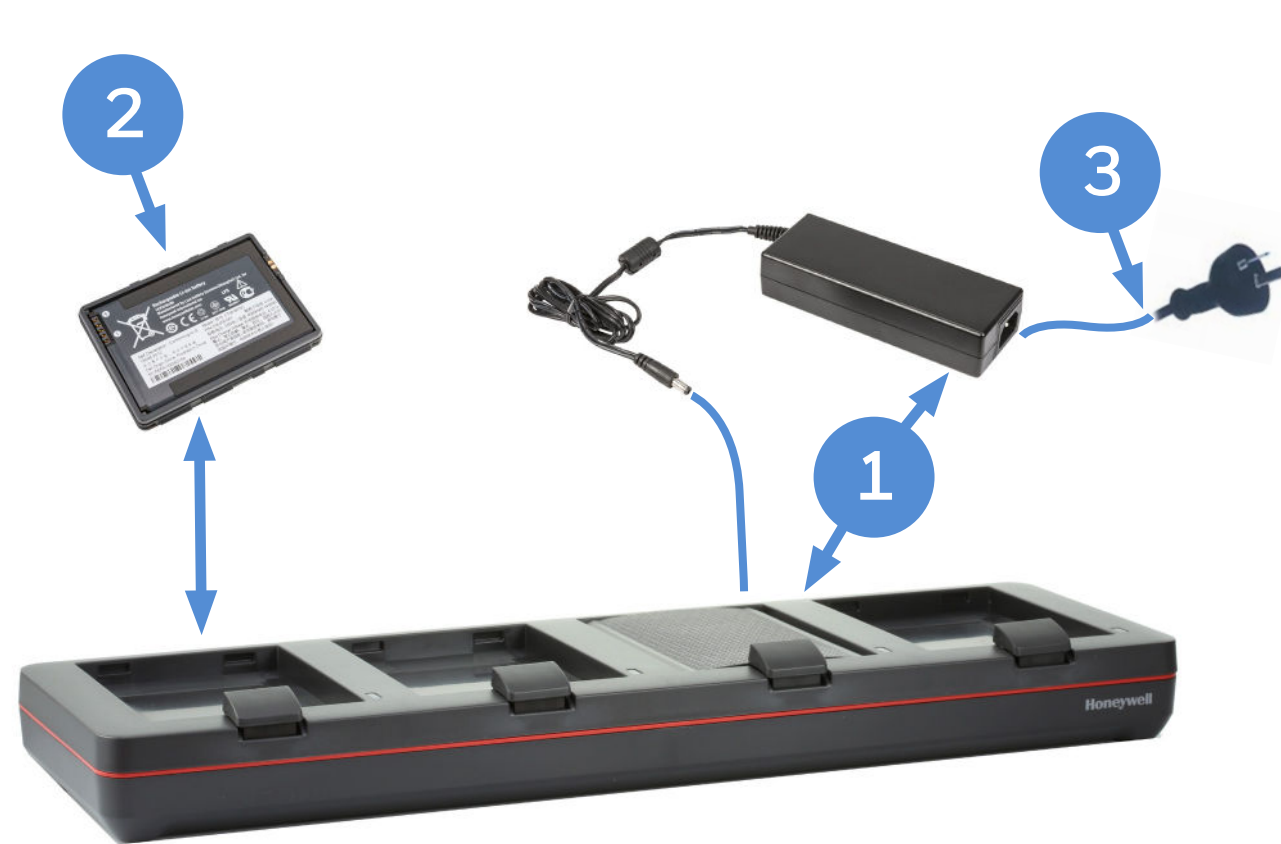

Batteries not included.

	PART NUMBER	DESCRIPTION
1	CT40-QBC-0	Quad Battery Charger - Kit includes Dock and Power Supply
2	**	Spare Battery - See Page 34 for Battery Selection
3	**	IEC C13 AC Power Cord - See Page 44 for Country Specific Power Cords

Option 8 - 1-Bay Quad Battery Charger with Universal Cup

Charge up to 4 batteries simultaneously

- Supports Batteries:
- 318-055-010 - Battery, Standard, CT40 Gen 1 (4090mAh)
 - 318-055-011 - Battery, Standard, CT40 Gen 1 (4040mAh)
 - 318-055-014 - Battery, Standard, CT40 Gen 2 (4090mAh)
 - 318-055-015 - Battery, Standard, CT40 Gen 2 (4020mAh)
 - 318-055-017 - Battery, Standard, CT40 Healthcare (4020mAh)
 - 318-055-067 - Battery, Standard, CT40 Gen 2 / XP, CT45 / XP (4020mAh)
 - 318-055-D67 - Battery, Standard, CT40 DRH / XP (4020mAh)
 - 318-055-H67 - Battery, Standard, CT40 Healthcare / XP (4020mAh)
 - CT4X-BTSC-001 - Battery, Standard, CT45 / CT47, 4775mAh
 - CT4X-BTWC-001 - Battery, Wireless, CT45 / CT47, 4680mAh
 - CT4X-BTSC-002 - Battery, NI / ATEX / IEC Ex, CT47, 4775mAh

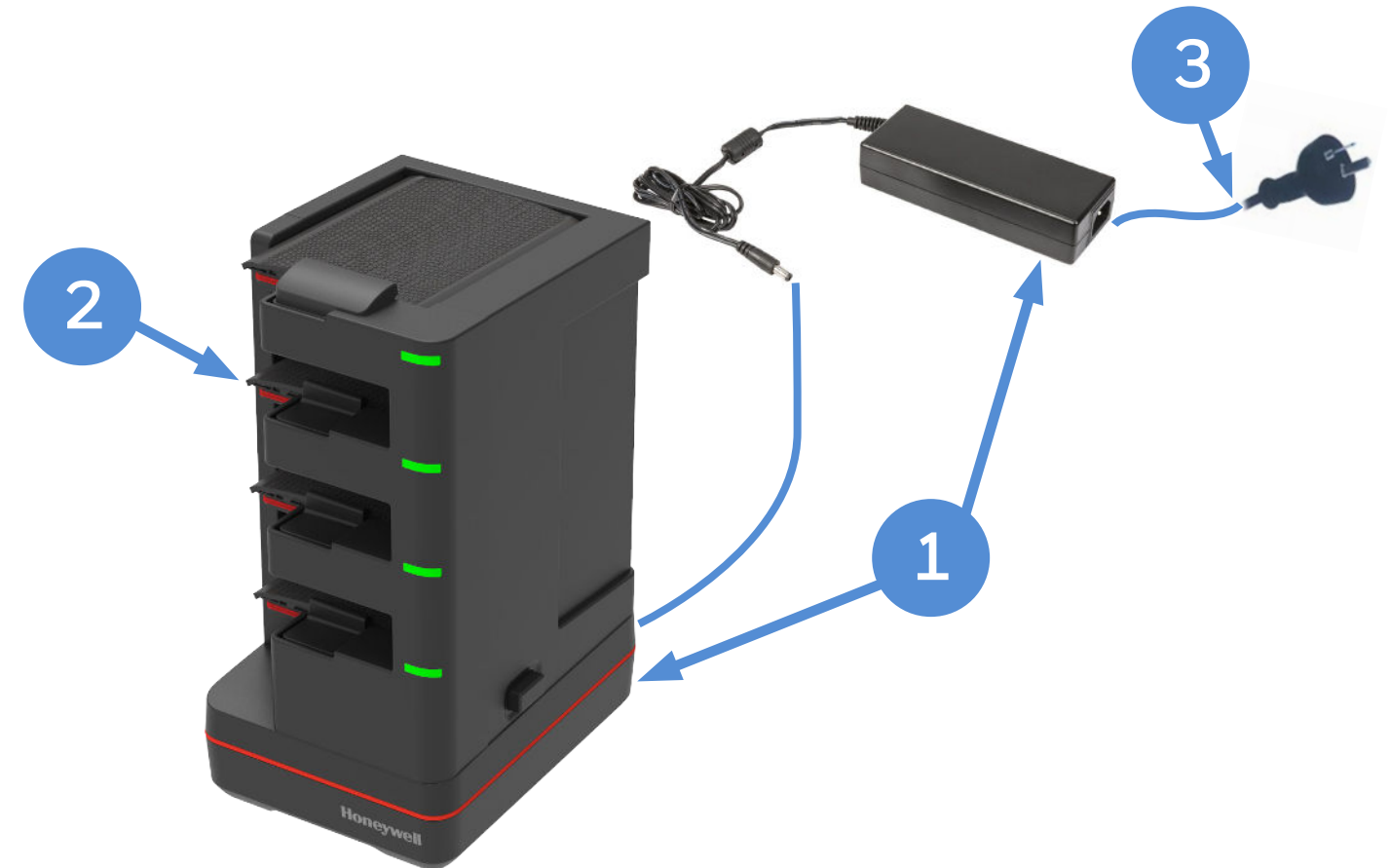

Batteries not included.

	PART NUMBER	DESCRIPTION
1	CT4X-QBC-1BAY-0	1-Bay Quad Battery Charger - Kit includes Dock and Power Supply
2	**	Spare Battery - See Page 34 for Battery Selection
3	**	IEC C13 AC Power Cord - See Page 44 for Country Specific Power Cords

CT47 CHARGING AND COMMUNICATION

Rack / Wall Mount Bracket

The Rack/Wall Mount Bracket has been optimized to work on a standard 19-inch (48cm) rack, as well as mounting directly onto a wall. Compatible with all 4-bay chargers.

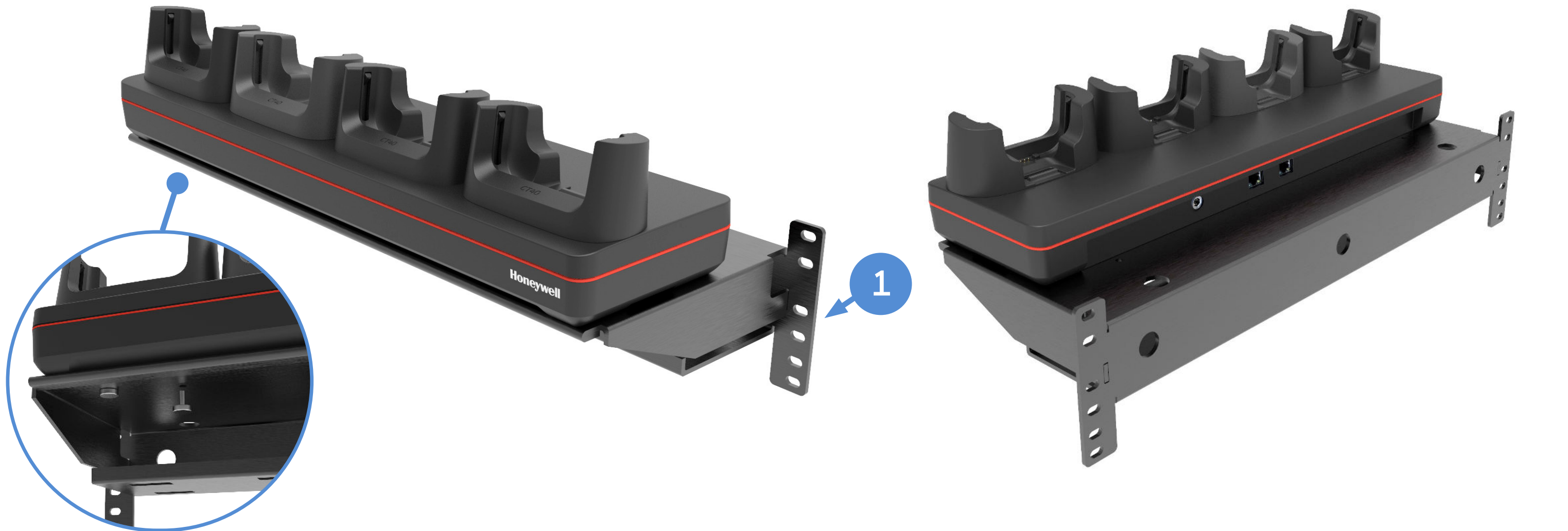

Thumb Screws View



Front View



Rear View



Power Supply Shelf View



Bottom View

	PART NUMBER	DESCRIPTION
1	CB-BK-01	4 Bay Charger Bracket, Rack / Wall Mount (includes 4 x 50180100-001 Thumb Screws M3.5x10 to securely attach the 4-bay dock to the bracket)

CT47 BATTERY

Spare Battery Options



CT47
CT47-xxx-xxxxx0x

CT47 Wireless Battery
CT47-xxx-xxxxx0x

CT47 NI / ATEX / IEC Ex
CT47-xxx-xxxxx1x

	PART NUMBER	DESCRIPTION
1	CT4X-BTSC-001	CT45 / CT47 Standard Battery Pack, 4775mAh
2	CT4X-BTWC-001	CT45 / CT47 Wireless Battery Pack, 4680mAh
3	CT4X-BTSC-002	CT47 NI / ATEX / IEC Ex Battery Pack, 4775mAh

CT47 RFID

IH40 RFID Reader with CT47 Non-Booted

Connect the IH40 to the CT47 via Bluetooth or USB.
IH40 has a user accessible replaceable battery.



IH40 Front View



IH40 Rear View



IH40 Top View

	PART NUMBER	REGION	DESCRIPTION
1	IH40-1-N003S02UK	FCC / ANZ	IH40 High-Performance UHF RFID tag reader, US Frequency Range of RFID output (902-928MHz), Includes Battery
OR	IH40-1-N003S02OK	ETSI	IH40 High-Performance UHF RFID tag reader, EU Frequency Range of RFID output (865-868 MHz), Includes Battery
2	IH40-BK-47		CT47 Non-Booted RFID bracket for IH40 and IH25, hand strap compatible
3	50155100-001		IH25 Wrist Strap

Honeywell Repair Services

SVCIH40-SG3N

IH40, Edge Service, Gold Maintenance Contract, 3 Year, New Contract

CT47 RFID

IH40 RFID Reader with CT47 Booted

Connect the IH40 to the CT47 via Bluetooth or USB.
IH40 has a user accessible replaceable battery.



IH40 Front View



IH40 Rear View



IH40 Top View

	PART NUMBER	REGION	DESCRIPTION
1	IH40-1-N003S02UK	FCC / ANZ	IH40 High-Performance UHF RFID tag reader, US Frequency Range of RFID output (902-928MHz), Includes Battery
OR	IH40-1-N003S02OK	ETSI	IH40 High-Performance UHF RFID tag reader, EU Frequency Range of RFID output (865-868 MHz), Includes Battery
2	IH40-BK-47PB		CT47 Booted RFID bracket for IH40 and IH25, hand strap compatible
3	CT47-PB-1		CT47 Hard Protective Boot
4	50155100-001		IH25 Wrist Strap

Honeywell Repair Services

SVCIH40-SG3N

IH40, Edge Service, Gold Maintenance Contract, 3 Year, New Contract

CT47 RFID CHARGING

Option 1 - IH40 Non-Booted Quad Charger

IH40 shares the same chargers as CT40/ CT45/ CT47.



Kit Includes:
4 x CT40-UCP-N
CT40 / CT45/ CT47 Cup for Non-Booted

Option 2 - IH40 Booted Quad Charger

IH40 shares the same chargers as CT40/ CT45/ CT47.

When using CT40 Booted chargers, the adapter sleeve is required to fit the IH40.

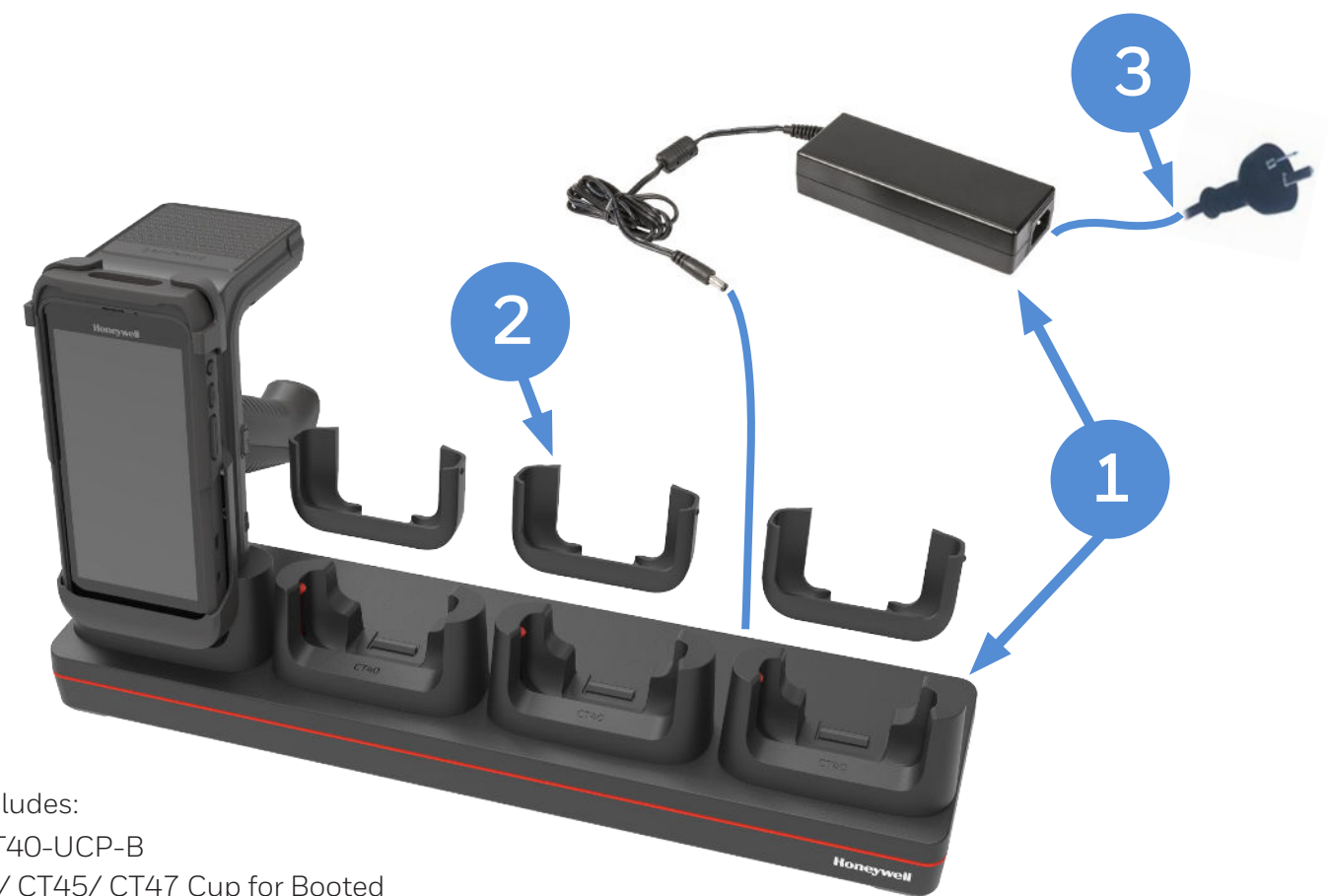

Kit Includes:
4 x CT40-UCP-B
CT40 / CT45/ CT47 Cup for Booted

	PART NUMBER	DESCRIPTION
1	CT40-CB-UVN-0	Non-Booted Chargebase - Kit includes Dock and Power Supply
OR	CT40-NB-UVN-0	Non-Booted Netbase - For Ethernet comms, Kit includes Dock and Power Supply
2	**	IEC C13 AC Power Cord – See Page 44 for Country Specific Power Cords

	PART NUMBER	DESCRIPTION
1	CT40-CB-UVB-0	Booted Chargebase - Kit includes Dock and Power Supply
OR	CT40-NB-UVB-0	Booted Netbase - For Ethernet comms, Kit includes Dock and Power Supply
2	IH40-ADP-SLV	IH40 Adapter Sleeve for Booted CT40 cup (CT40-UCP-B) - Order 4 adapters per Charge Base
3	**	IEC C13 AC Power Cord – See Page 44 for Country Specific Power Cords

CT47 RFID

Option 3 - IH40 Quad Battery Charger

IH40 shares the same chargers as EDA50/ EDA51 battery charger.

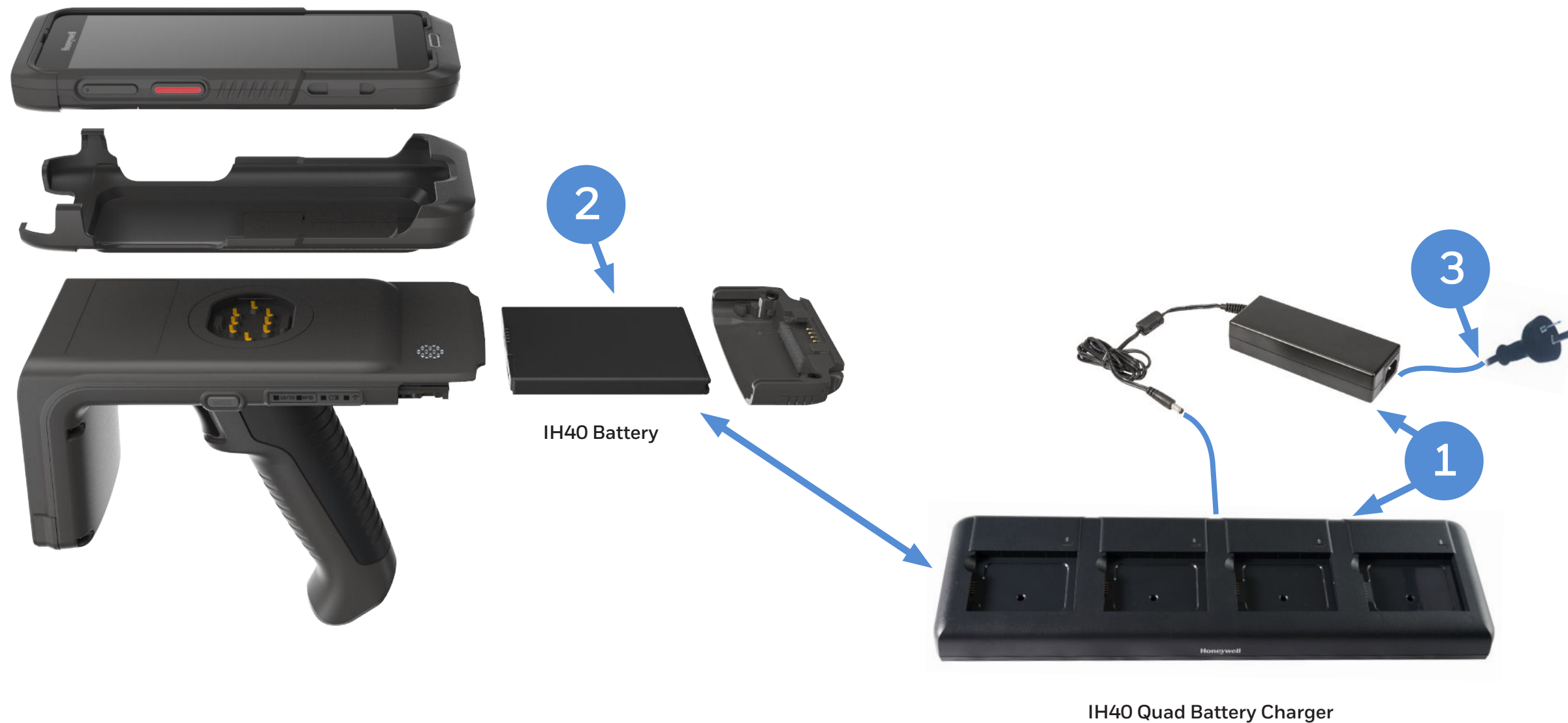

PART NUMBER	DESCRIPTION
1	EDA50-QBC-0 Kit IH25/IH40/EDA50/EDA70/EDA71 Quad Battery Charger. Kit includes Dock, Power Supply, No Power Cord.
2	50129589-001 Accessory, Battery (3.8V, 4,000mAh), EDA50/51/70/71
3	** IEC C13 AC Power Cord – See Page 44 for Country Specific Power Cords

CT47 HEADSET

USB-C CT47 Push To Talk (PTT) Headset

USB-C audio PTT and VoIP ready to support In-Store Communication with leading 3rd party applications.
Compatible with CT47-PB-1 Boot installed.



PART NUMBER **DESCRIPTION**

1 MBL-HDST-USBC Headset with PTT, USB C

MISCELLANEOUS

Optional Parts



PART NUMBER	DESCRIPTION
CT47-HS-3PK	CT47 HAND STRAP, pack of 3



Note: Stylus is not to be used with screen protector

PART NUMBER	DESCRIPTION
213-048-001	Pack of 5 CT40 / CT50 / CT60 replacement styluses.
8754-871600-20	Pack of 10 CT40 / CT50 / CT60 replacement styluses.

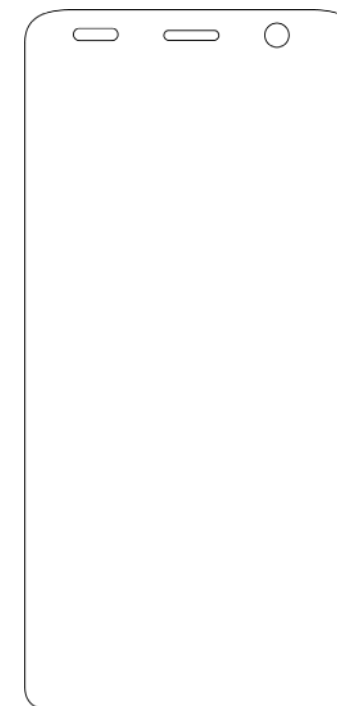

PART NUMBER	DESCRIPTION
CT47-SP-1PK	CT47 Screen Protector, 1 Pack

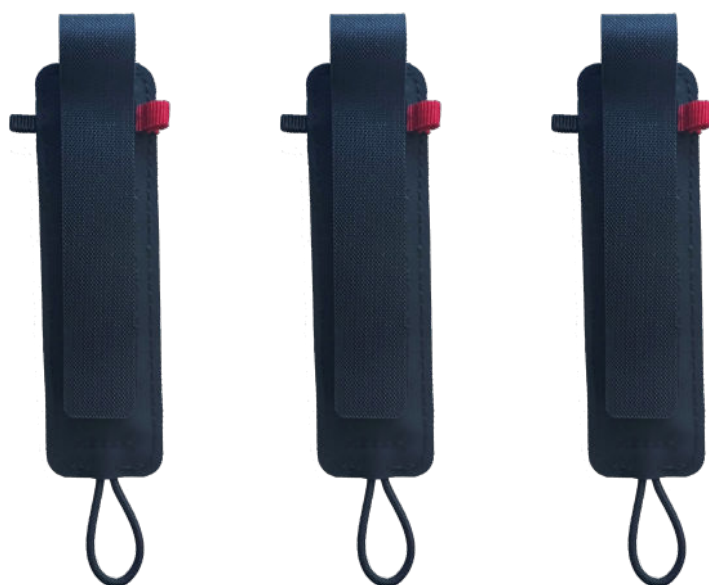

PART NUMBER	DESCRIPTION
CT45-HS-FM	CT45 HAND STRAP for Field Mobility 3 pieces per pack. Larger handstrap for field mobility workers with big hands or those who wear gloves. Compatible with Vehicle Docks.



PART NUMBER	DESCRIPTION
CT40-STL-1PKC	CT40 and CT45 Stylus for use with or without screen protectors. Pack of 1.



PART NUMBER	DESCRIPTION
825-239-001	HOLSTER,SCAN HANDLE, CT4X, CT50, CT60 and CT60 XP

MISCELLANEOUS

Optional Parts

Replacement Power Supplies.



IEC C14

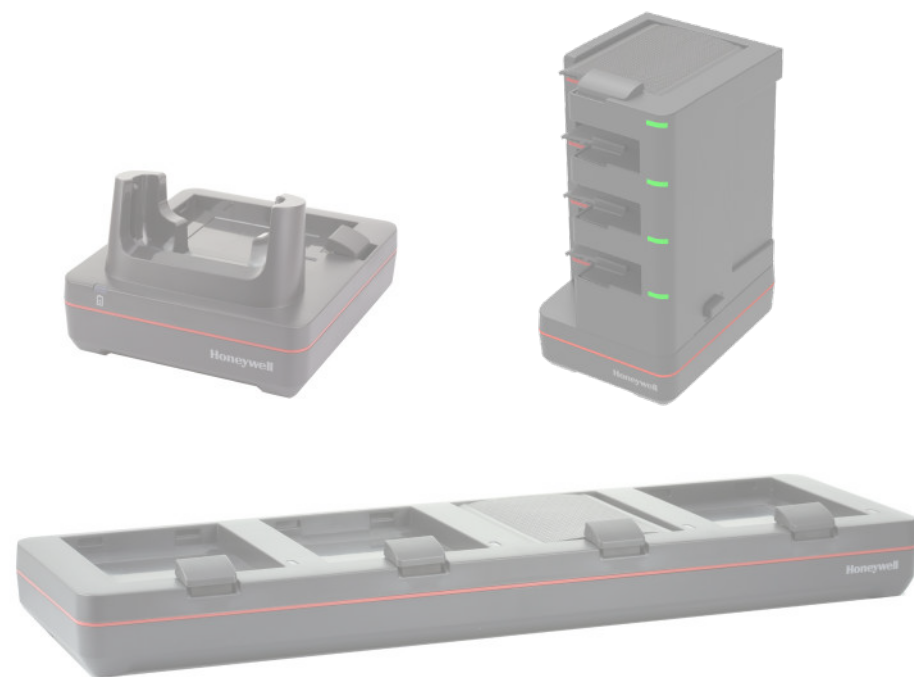

PART NUMBER DESCRIPTION

50121666-001 Power Adapter, 12V 3A, No Power Cord, Compatible with CT40 Homebase / eHomebase / Quad Battery Charger (Requires IEC C13 AC Power Cord)



IEC C14

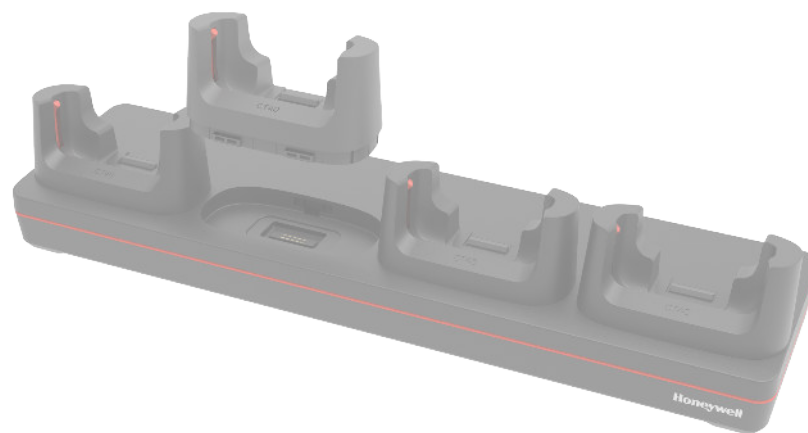

PART NUMBER DESCRIPTION

50121667-001 Power Adapter, 12V 7A, No Power Cord, CT40 Quad Chargebase/Quad Netbase (Requires IEC C13 AC Power Cord)



IEC C6

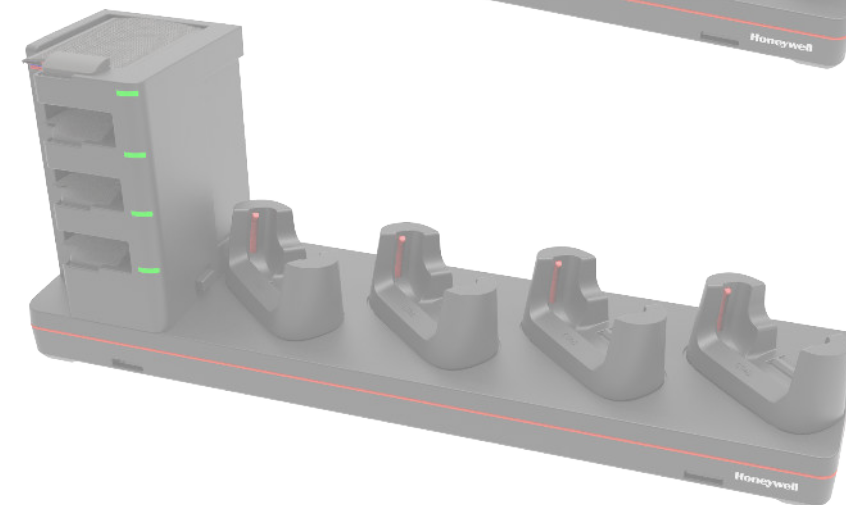
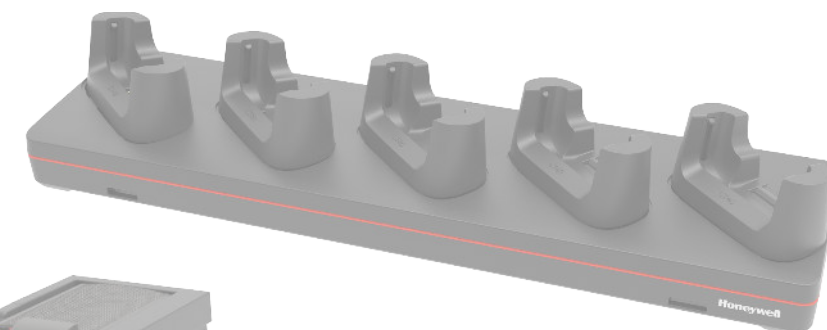

PART NUMBER DESCRIPTION

3007-3408-001 Power Supply 12V 8.3A R7B ADS-120QL-12-3 120100E 5-Bay Charge Base (Requires IEC C5 AC Power Cord)

MISCELLANEOUS

Optional Parts



PART NUMBER	DESCRIPTION
CT40-UCP-N	CT40 Non-Booted universal cup, to be used for CT40 without protective boot



PART NUMBER	DESCRIPTION
CT40-UCP-B	CT40 Booted universal cup, to be used for CT40 with protective boot (CT45-PB-1)



PART NUMBER	DESCRIPTION
CT45-VD-IST	CT45 Vehicle dock plastic insert, can be used along with CT40-VD-CNV and CT45-VD-CNV



Batteries not included.

PART NUMBER	DESCRIPTION
CT45-BAT-CUP	CT45/CT40 Universal Battery Cup Compatible CT45-5CB-UVN-BAT-0, CT45-5CB-UVB-BAT-0 and CT4X-QBC-1BAY-0

MISCELLANEOUS

Optional Parts



PART NUMBER	DESCRIPTION
825-237-001	POUCH, CT40/CT50/CT60/CT60 XP

PART NUMBER	DESCRIPTION
825-238-001	CT40/CT50/CT60/CT60 XP Holster

MISCELLANEOUS

Micro-SD Cards

Honeywell Recommended – ATP Industrial Grade Micro SD Cards

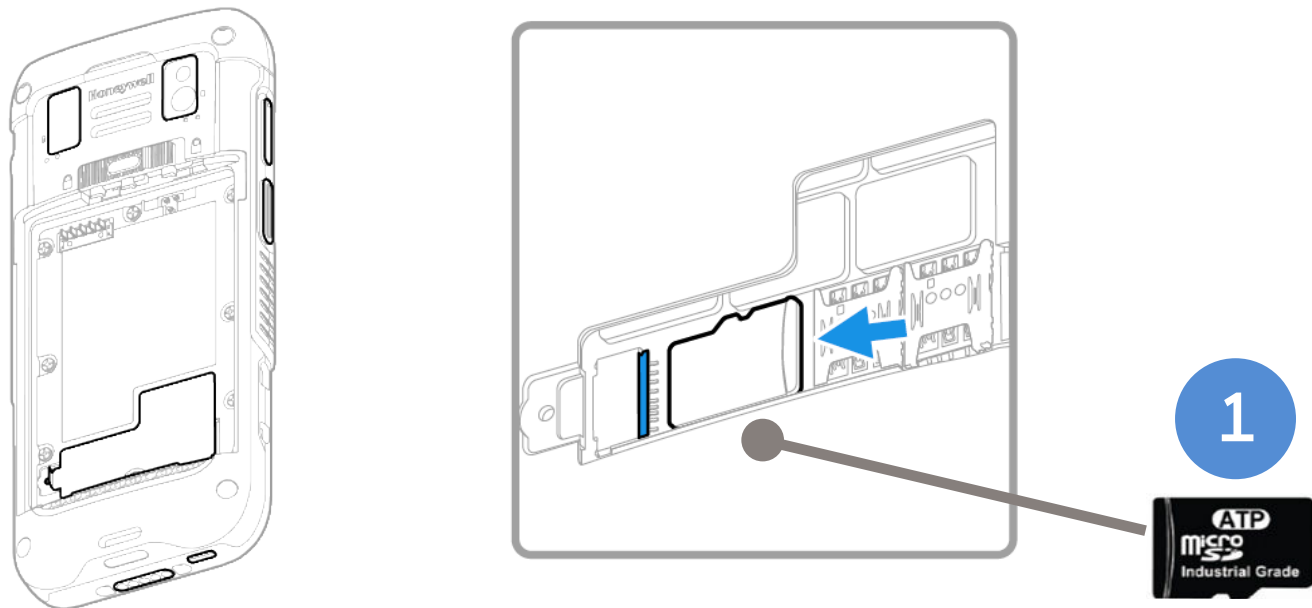

Why ATP Industrial Grade SD?

ATP's SIP (System-In-Packaging) manufacturing process encapsulates all exposed components and points of failure to ensure the products are fully waterproof, shockproof, and ESD (Electro-Static Discharge) proof. ATP Industrial Grade SD/SDHC Cards can withstand at least an operating/storage temperature range of at least -40 to 85 degrees Celsius. In addition to this temperature range, the cards are completely waterproof, dustproof, and ESD (Electro-Static Discharge) proof. All ATP Industrial Grade SD/SDHC cards are produced under a stringent RoHS and Green Package compliant manufacturing process to guarantee a consistent high level of build quality and performance. ATP Industrial SD cards deliver outstanding performance with read speed (seq) up to 18MB/sec and write speed (seq) up to 16MB/sec. All ATP Industrial Grade CF, SD, USB drives, and SSDs are constructed using best-in-class SLC(Single-Level Cell) components with enhanced Error Correction Code(ECC) functions and wear levelling algorithms. This results in MTBF ratings over 2 million hours and the highest write cycle lifetimes in the industry.

	PART NUMBER	DESCRIPTION
1	856-065-004	MICRO-SD CARD, 1GB , AFIGUDI, ROHS
OR	856-065-005	MICRO-SD CARD, 2GB , AFIGUDI, ROHS
OR	856-065-006	MICRO-SD CARD, 4GB , AFIGUDI, ROHS
OR	856-065-007	MICRO-SD CARD, 8GB , AFIGUDI, ROHS

AC Cords

Regional Power Cords



AC Power - C13 Type Connector

PART NUMBER	DESCRIPTION
50117501-001	POWER CORD AUSTRALIA 2500MM,SLED CB
321-501-002	AC Power Cord, Denmark RoHS
77900508E	Cable: power cord, power supply to AC outlet, straight, Power cord, Europe EU, IEC320-C13, 2.5 m (8.2 ft)
321-502-002	AC Power Cord, India/South Africa RoHS
321-500-002	AC Power Cord, Japan RoHS
9000093CABLE	AC POWER CABLE, C14 TYPE, SWITZERLAND 3-PIN
77900507E	Cable: power cord, power supply to AC outlet, straight - Power cord, UK, IEC320-C13, 2.5 m (8.2 ft)
1-974028-025	AC Power Cord, US RoHS



AC Power - C5 Type Connector

PART NUMBER	DESCRIPTION
3007-4681-001	C5 type power cable, USA
3007-4683-001	C5 type power cable, Europe
3007-4682-001	C5 type power cable, UK
3007-4684-001	C5 type power cable, Australia

MISCELLANEOUS

Disclaimer

Honeywell International Inc. (“HII”) reserves the right to make changes in specification and other information contained in this document without prior notice, and the reader should in all cases consult HII to determine whether any such changes have been made. The information in this publication does not represent a commitment on the part of HII.

HII shall not be liable for technical or editorial errors or omissions contained herein; nor for incidental or consequential damages resulting the furnishing, performance, or use of this material.

This document contains proprietary information that is protected by copyright. All rights are reserved. No part of this document may be photocopied, reproduced, or translated into another language with-out prior written consent of HII.

Web Address: www.honeywellaidc.com

The Bluetooth trademarks are owned by Bluetooth SIG, Inc., U.S.A and licensed to Honeywell.

Thor and Mobility Edge are trademarks or registered trademarks of Honeywell International Inc. in the United States and/or other countries.

Android is a trademark or registered trademark of Google Inc. in the United States and/or other countries. Windows is a trademark or registered trademark of Microsoft Corporation.

Qualcomm and Snapdragon are trademarks or registered trademarks of Qualcomm Incorporated in the United States and/or other countries.

Other product names mentioned in the manual may be trademarks of registered trademarks of their respective companies and are the property of their respective owners.

All rights reserved.

For more information

sps.honeywell.com

Honeywell Safety and Productivity Solutions

300 S Tryon St Suite 500

Charlotte, NC 28202

800-582-4263

www.honeywell.com