

datavideo

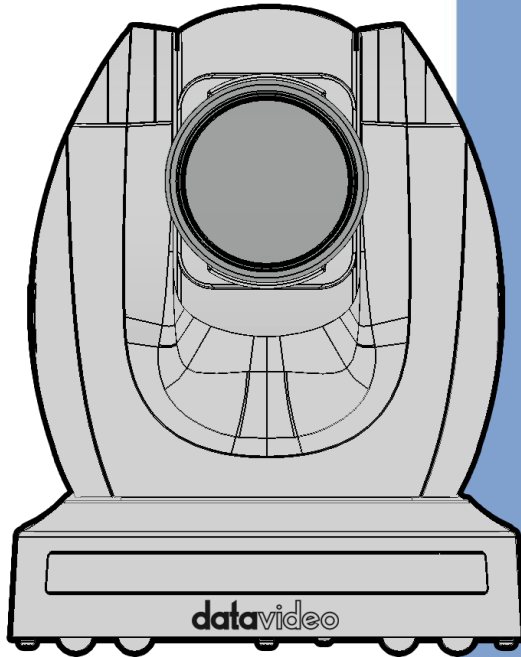

4K TRACKING PTZ
CAMERA
PTC-285T
Instruction Manual

www.datavideo.com

Table of Contents

FCC COMPLIANCE STATEMENT	5
WARNINGS AND PRECAUTIONS	5
WARRANTY	6
<i>STANDARD WARRANTY</i>	6
<i>THREE YEAR WARRANTY</i>	7
DISPOSAL	7
1. PRODUCT OVERVIEW	8
FEATURES.....	8
2. LOCATION AND FUNCTION OF PARTS	9
CAMERA	9
<i>Front</i>	9
<i>Rear</i>	10
<i>Bottom</i>	12
RECEIVER BOX.....	14
<i>Front</i>	14
<i>Rear</i>	16
3. INSTALLATION INSTRUCTIONS	17
4. NETWORK CONNECTION.....	22
DHCP MODE	22
STATIC IP	24
DVIP	24
5. BASIC SETUP	27
POWER-ON INITIALIZATION.....	27
VIDEO OUTPUT	27
<i>HDBaseT/POE Port</i>	27
<i>HDMI Video OUT</i>	29
<i>3G-SDI Video Output</i>	29
6. IR REMOTE CONTROL AND ON-SCREEN MENU.....	30
IR REMOTE CONTROL.....	30
OSD MENU.....	34

7. WEB USER INTERFACE	40
CAMERA CONTROL.....	40
<i>Focus</i>	41
<i>Zoom</i>	41
<i>Pan and Tilt</i>	42
<i>Speed</i>	42
<i>AT</i>	42
<i>Home</i>	42
<i>Presets</i>	42
CAMERA SETUP	43
<i>Basic Image Settings (Page 1)</i>	43
<i>Exposure (Page 1)</i>	43
<i>White Balance (Page 1)</i>	45
<i>Advanced Image Settings (Page 2)</i>	46
VIDEO OUTPUT	47
STREAM	48
<i>RTP Multicast</i>	50
<i>RTSP</i>	51
<i>RTMP(S)</i>	53
<i>SRT</i>	61
<i>Onvif</i>	67
NETWORK	67
<i>Network Settings</i>	68
<i>NTP Settings</i>	68
AUDIO	68
<i>Audio Input</i>	69
<i>Soundtrack</i>	69
<i>Audio Standard</i>	69
<i>Sample Rate</i>	69
<i>Bitrate</i>	69
<i>ADTS Options</i>	69
SYSTEM.....	69
<i>General</i>	69
<i>Firmware</i>	70
<i>Account and Password</i>	70
AUTO-TRACKING	71
<i>Mode</i>	71
<i>Figure Size</i>	72
<i>AT Speed</i>	73

8. REMOTE CONTROL.....	74
RS-422	74
Wi-Fi	75
9. FIRMWARE UPDATE.....	76
ETHERNET PORT	76
<i>Requirements</i>	76
<i>Procedure</i>	76
10. FREQUENTLY-ASKED QUESTIONS.....	78
11. DIMENSIONS.....	80
12. SPECIFICATIONS.....	81
SERVICE AND SUPPORT	84

Disclaimer of Product and Services

The information offered in this instruction manual is intended as a guide only. At all times, Datavideo Technologies will try to give correct, complete and suitable information. However, Datavideo Technologies cannot exclude that some information in this manual, from time to time, may not be correct or may be incomplete. This manual may contain typing errors, omissions or incorrect information. Datavideo Technologies always recommend that you double check the information in this document for accuracy before making any purchase decision or using the product. Datavideo Technologies is not responsible for any omissions or errors, or for any subsequent loss or damage caused by using the information contained within this manual. Further advice on the content of this manual or on the product can be obtained by contacting your local Datavideo Office or dealer.

FCC Compliance Statement

This device complies with part 15 of the FCC rules. Operation is subject to the following two conditions:

- (1) This device may not cause harmful interference, and
- (2) This device must accept any interference received, including interference that may cause undesired operation.

Warnings and Precautions

1. Read all of these warnings and save them for later reference.
2. Follow all warnings and instructions marked on this unit.
3. Unplug this unit from the wall outlet before cleaning. Do not use liquid or aerosol cleaners. Use a damp cloth for cleaning.
4. Do not use this unit in or near water.
5. Do not place this unit on an unstable cart, stand, or table. The unit may fall, causing serious damage.
6. Slots and openings on the cabinet top, back, and bottom are provided for ventilation. To ensure safe and reliable operation of this unit, and to protect it from overheating, do not block or cover these openings. Do not place this unit on a bed, sofa, rug, or similar surface, as the ventilation openings on the bottom of the cabinet will be blocked. This unit should never be placed near or over a heat register or radiator. This unit should not be placed in a built-in installation unless proper ventilation is provided.
7. This product should only be operated from the type of power source indicated on the marking label of the AC adapter. If you are not sure of the type of power available, consult your Datavideo dealer or your local power company.
8. Do not allow anything to rest on the power cord. Do not locate this unit where the power cord will be walked on, rolled over, or otherwise stressed.
9. If an extension cord must be used with this unit, make sure that the total of the ampere ratings on the products plugged into the extension cord do not exceed the extension cord's rating.
10. Make sure that the total amperes of all the units that are plugged into a single wall outlet do not exceed 15 amperes.
11. Never push objects of any kind into this unit through the cabinet ventilation slots, as they may touch dangerous voltage points or short out parts that could result in risk of fire or electric shock. Never spill liquid of any kind onto or into this unit.



12. Except as specifically explained elsewhere in this manual, do not attempt to service this product yourself. Opening or removing covers that are marked “Do Not Remove” may expose you to dangerous voltage points or other risks, and will void your warranty. Refer all service issues to qualified service personnel.
13. Unplug this product from the wall outlet and refer to qualified service personnel under the following conditions:
 - a. When the power cord is damaged or frayed;
 - b. When liquid has spilled into the unit;
 - c. When the product has been exposed to rain or water;
 - d. When the product does not operate normally under normal operating conditions. Adjust only those controls that are covered by the operating instructions in this manual; improper adjustment of other controls may result in damage to the unit and may often require extensive work by a qualified technician to restore the unit to normal operation;
 - e. When the product has been dropped or the cabinet has been damaged;
 - f. When the product exhibits a distinct change in performance, indicating a need for service.

Warranty

Standard Warranty

- Datavideo equipment are guaranteed against any manufacturing defects for one year from the date of purchase.
- The original purchase invoice or other documentary evidence should be supplied at the time of any request for repair under warranty.
- The product warranty period begins on the purchase date. If the purchase date is unknown, the product warranty period begins on the thirtieth day after shipment from a Datavideo office.
- All non-Datavideo manufactured products (product without Datavideo logo) have only one year warranty from the date of purchase.
- Damage caused by accident, misuse, unauthorized repairs, sand, grit or water is not covered under warranty.
- Viruses and malware infections on the computer systems are not covered under warranty.
- Any errors that are caused by unauthorized third-party software installations, which are not required by our computer systems, are not covered under warranty.
- All mail or transportation costs including insurance are at the expense of the owner.

- All other claims of any nature are not covered.
- All accessories including headphones, cables, and batteries are not covered under warranty.
- Warranty only valid in the country or region of purchase.
- Your statutory rights are not affected.

Three Year Warranty

- All Datavideo products purchased after July 1st, 2017 are qualified for a free two years extension to the standard warranty, providing the product is registered with Datavideo within 30 days of purchase.
- Certain parts with limited lifetime expectancy such as LCD panels, DVD drives, Hard Drive, Solid State Drive, SD Card, USB Thumb Drive, Lighting, Camera module, PCIe Card are covered for 1 year.
- The three-year warranty must be registered on Datavideo's official website or with your local Datavideo office or one of its authorized distributors within 30 days of purchase.



Disposal

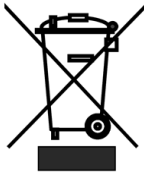

For EU Customers only - WEEE Marking

This symbol on the product or on its packaging indicates that this product must not be disposed of with your other household waste. Instead, it is your responsibility to dispose of your waste equipment by handing it over to a designated collection point for the recycling of waste electrical and electronic equipment. The separate collection

and recycling of your waste equipment at the time of disposal will help to conserve natural resources and ensure that it is recycled in a manner that protects human health and the environment. For more information about where you can drop off your waste equipment for recycling, please contact your local city office, your household waste disposal service or the shop where you purchased the product.

1. Product Overview

The PTC-285T incorporates a 1/2.8" CMOS sensor, enabling superior 2160p50/60 UHD video output. It boasts a 12x optical zoom, complemented by a 16x digital zoom and offers multiple output interfaces like 3G-SDI, HDMI, and IP streaming.

The camera also features HDBaseT Technology, enabling extension of video transmission up to 100m over a standard CAT Ethernet cable.

Elevate your remote video production effortlessly with the PTC-285T — a clear frontrunner for enhanced capabilities.

Features

- 2160p50/59.94/60 PTZ camera
- 12x Optical Zoom, 16x Digital Zoom
- 4K Video interfaces: HDMI, H.264/H.265 Streaming
- 2160p and 1080p (3G-SDI) Simultaneous video output
- RS-422 Serial Port Control
- External audio input: 3.5mm audio in/line in (switchable on the web UI)
- Friendly web UI
- White color model available.

2. Location and Function of Parts

Camera

Front



1	Lens Built-in 1/2.8" 8.51M Pixel CMOS 4K color camera with white balance control, backlight compensation, automatic gain, etc.
2	Tally LED Tally lamp will be turned ON upon receiving the ON signal.
3	Sensor for Remote Control Remote control IR receiver

Rear



- | | |
|---|--|
| 1 | USB Port
Insert a USB drive containing the latest firmware file and use the OSD menu to start the firmware upgrade process.
Note: See Firmware Update section for details. |
| 2 | Power Input
DC in socket connects the supplied 12V PSU. The connection can be secured by screwing the outer fastening ring of the DC In plug to the socket. |
| 3 | 4K HDMI OUT
The 4K HDMI OUT allows you to connect an external HDMI monitor via an HDMI cable. |

4	<p>3G-SDI OUT</p> <p>The 3G-SDI OUT allows you to connect an external monitor via an SDI cable.</p>
5	<p>MIC IN/LINE IN</p> <p>The 3.5mm audio input receives external audio.</p> <p>Note: Use the OSD Menu or Web UI to switch between MIC IN and LINE IN.</p>
6	<p>RS-422 Interface (RJ-45)</p> <p>The RS-422 interface is designed to connect an external RS-422 device using a custom Ethernet cable. See the section on RS-422 for wiring pinouts.</p>
7	<p>IRID DIP Switch</p> <p>The IRID DIP Switch is used to assign an ID number (1 to 4) to the camera. Simply toggle switches 1 and 2 on/off according to one of the combinations listed below to assign an ID number to the camera so that the user can use the IR remote control's camera select keys to select the camera.</p> <div style="display: flex; align-items: center; margin: 10px 0;">  <div style="margin-left: 20px;"> <p>(1,2) = (0,0) CAM1</p> <p>(1,2) = (1,0) CAM2</p> <p>(1,2) = (0,1) CAM3</p> <p>(1,2) = (1,1) CAM4</p> </div> </div> <p>Note: Switches 3/4 should be always OFF.</p>
8	<p>HDBaseT/POE Interface</p> <p>Connect the camera to a receiver box through the HDBaseT interface, enabling an extended transmission distance of up to 100 meters. Connect this port to the HDBaseT port on the receiver box using a CAT6A Ethernet cable. Subsequently, the receiver box outputs HDMI video to an external monitor. Additionally, the HDBaseT port supports Power over Ethernet (PoE) functionality. To make use of HDBaseT Technology, you will need to purchase an HBT-16 receiver box off the shelf from Datavideo. See Receiver Box for more information about the hardware setup.</p>

Bottom

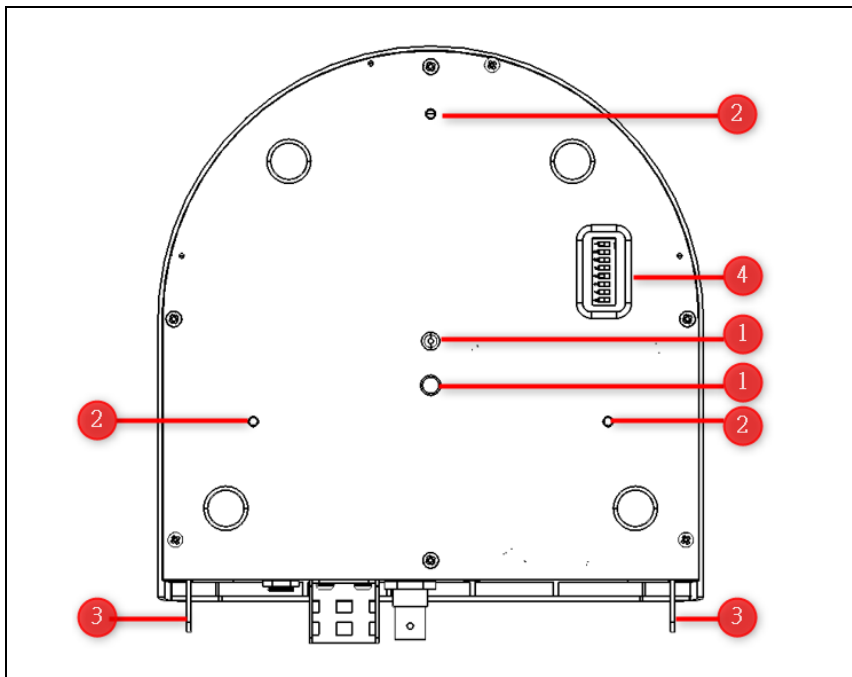

1	Tripod Screw Hole allows the user to mount the camera on the tripod.
2	Screw Hole Screw holes for ceiling bracket mounting.
3	For Safety Rope Ties safety ropes for securing the camera to the ceiling.

DIP Switch

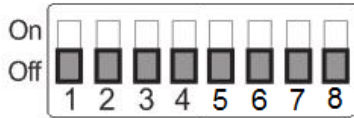

The DIP Switch allows the user to set the camera's VISCA ID, select the video resolution, and configure how the video format (or resolution) can be selected. See the following table for corresponding settings:

4

DIP SW 1/2/3	VISCA ID
(1,2,3) = (ON,OFF,OFF)	VISCA-ID 1
(1,2,3) = (OFF,ON ,OFF)	VISCA-ID 2
(1,2,3) = (ON ,ON ,OFF)	VISCA-ID 3
(1,2,3) = (OFF,OFF,ON)	VISCA-ID 4
(1,2,3) = (ON ,OFF,ON)	VISCA-ID 5
(1,2,3) = (OFF,ON ,ON)	VISCA-ID 6
(1,2,3) = (ON ,ON ,ON)	VISCA-ID 7
DIP SW 4	Remote Control Protocol
(4) = (Don't Care)	RS-422/DVIP accessible upon connection
DIP SW 5/6/7	Resolution
(5,6,7) = (OFF,OFF,OFF)	1920 x 1080i 59.94
(5,6,7) = (ON,OFF,OFF)	1920 x 1080i 50
(5,6,7) = (OFF,ON,OFF)	1920 x 1080p 59.94
(5,6,7) = (ON,ON,OFF)	1920 x 1080p 50
(5,6,7) = (OFF,OFF,ON)	3840 x 2160p 29.97
(5,6,7) = (ON,OFF,ON)	3840 x 2160p 25
(5,6,7) = (OFF,ON,ON)	3840 x 2160p 59.94
(5,6,7) = (ON,ON,ON)	3840 x 2160p 50
DIP SW 8	Video Format (Resolution) Selection Means
ON	DIP switch
OFF	OSD Menu

Receiver Box

To make use of HDBaseT Technology, you will need to purchase an HBT-16 receiver box off the shelf from Datavideo. This section provides an overview of the box.

Front

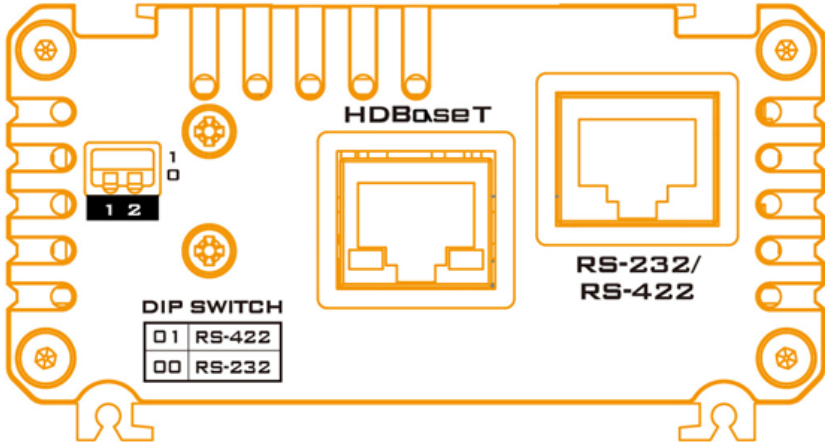

HDBaseT Port

Use a CAT6A Ethernet cable to connect the HDBaseT ports of the camera and the receiver box.

Note: Visit the [HDBaseT Alliance homepage](#) for cable recommendation.



RS-232/RS-422 Interface

The RS-232/RS-422 port connects HBT-16 directly to Datavideo's camera controllers such as RMC-180, RMC-300A or RMC-300C. Use an RS-232 or RS-422 custom Ethernet cable to connect. **See the following RS-232/RS-422 pinouts for making the respective cables.**

Note: Use the DIP switch to select between RS-232 (00) and RS-422 (01).



RS-232

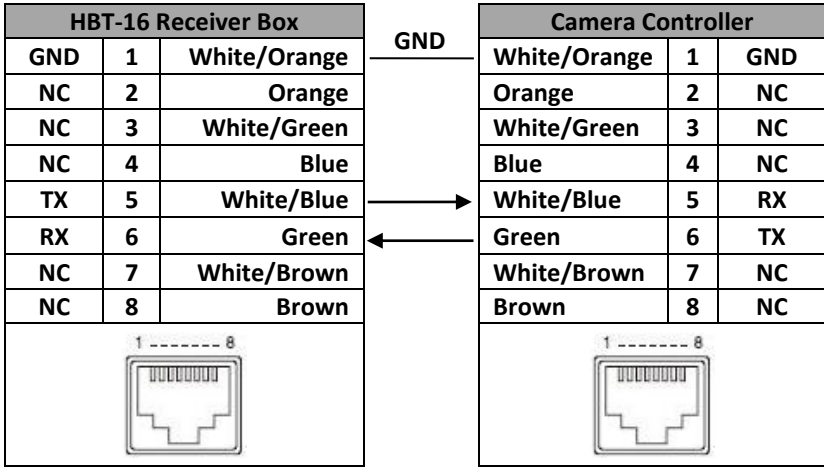

RS-422

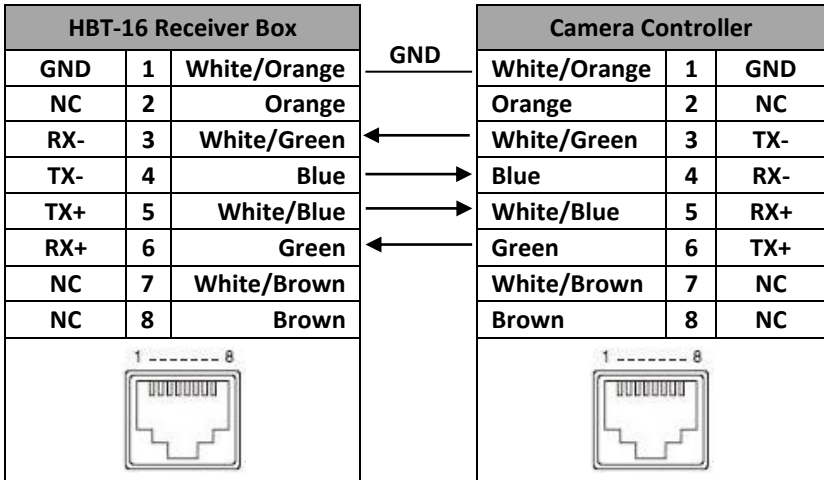

Rear

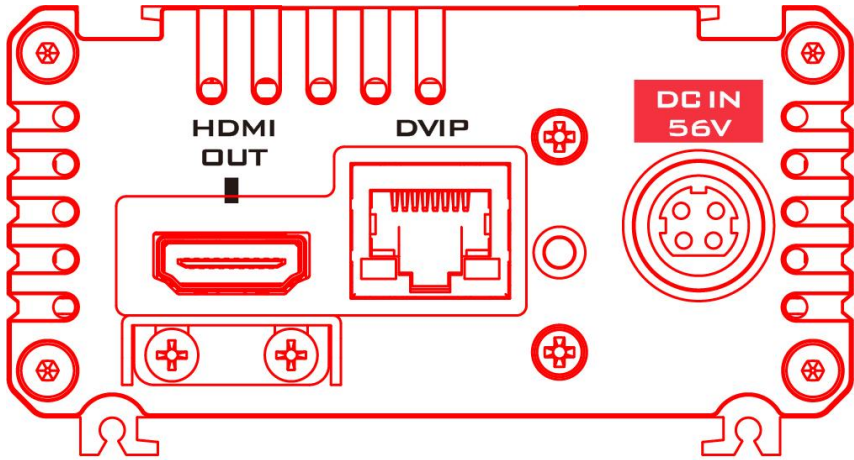

HDMI
OUT



HDMI OUT

HDMI port for video output.

DVIP

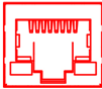

DVIP Port

The DVIP interface is a protocol designed by Datavideo to allow the user to access the camera's Web UI by simply connecting a PC to the DVIP port using a standard Ethernet cable. See [Network Connection](#) for establishing connection and [Web User Interface](#) for accessing the camera's internal settings.

DC IN
56V

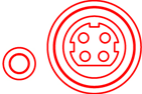

56V DC IN

56V DC power input connection

Power LED Indicator

ON: Power connected

OFF: Power disconnected

3. Installation Instructions

Note: Only mount the bracket on formwork or concrete surface. Do NOT mount the bracket on plasterboard.

Step 1 – DIP Switch Setting

Enable Flip-H and Flip-V.

Step 2 – One End of Retaining Wire

Attach the retaining wire to the junction box mounted on the ceiling by screwing one end of the retaining wire into a screw hole in the junction box with a screw (not supplied) as shown in the diagram below.

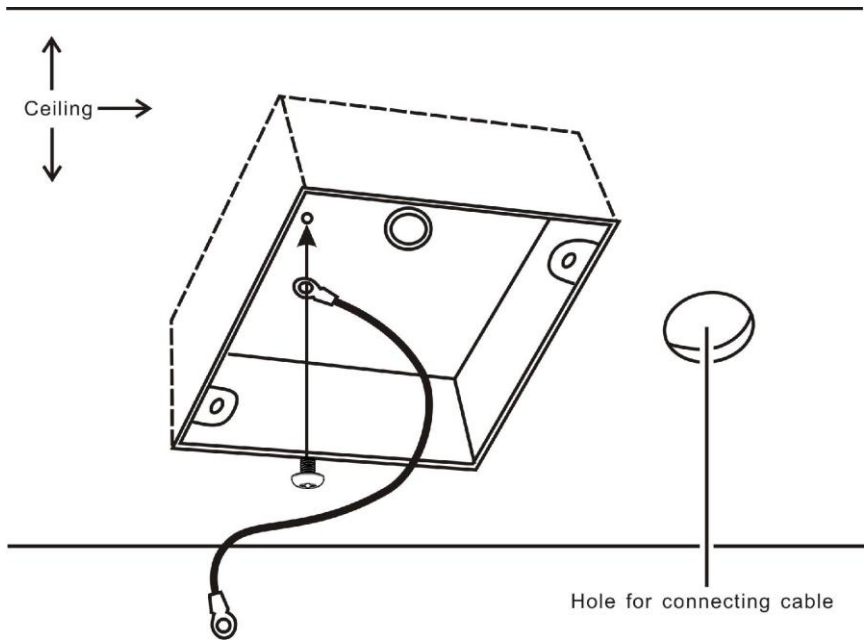

Step 3 – Ceiling Bracket (B)

Again, as illustrated in the diagram below, screw a ceiling bracket (B) into the junction box mounted on the ceiling.

Make sure the screw holes of the ceiling bracket (B) are aligned with the holes on the junction box.

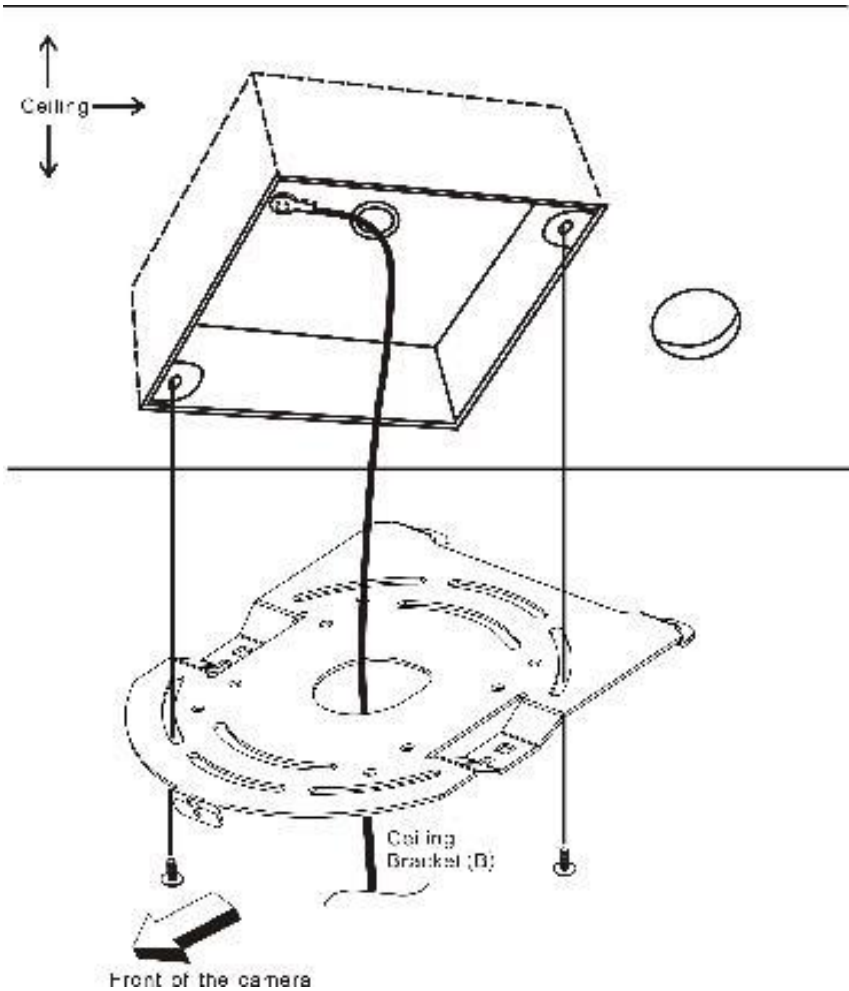

Step 4 – Ceiling Bracket (A) and Camera

- Screw ceiling bracket (A) into the bottom of the camera using three screws.
- Position the screws as shown in the diagram below.
- Align the screw holes on the bottom of the camera with those in the ceiling bracket.
- Insert the screws into the corresponding screw holes in the numbered order.
- The other end of the retaining wire is screwed into the screw hole #3.
- Securely tighten all three screws.

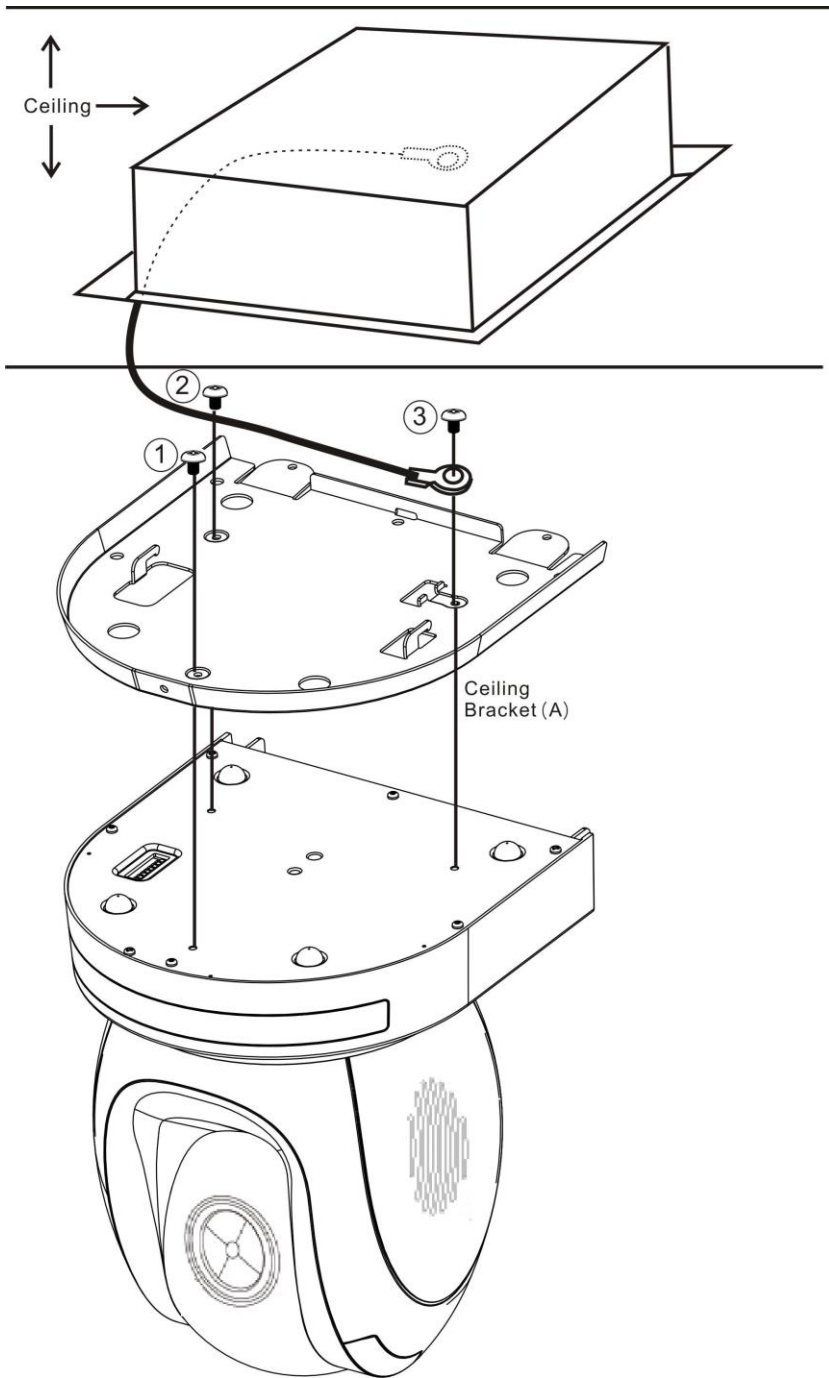

Step 5 – Mount Camera to Ceiling

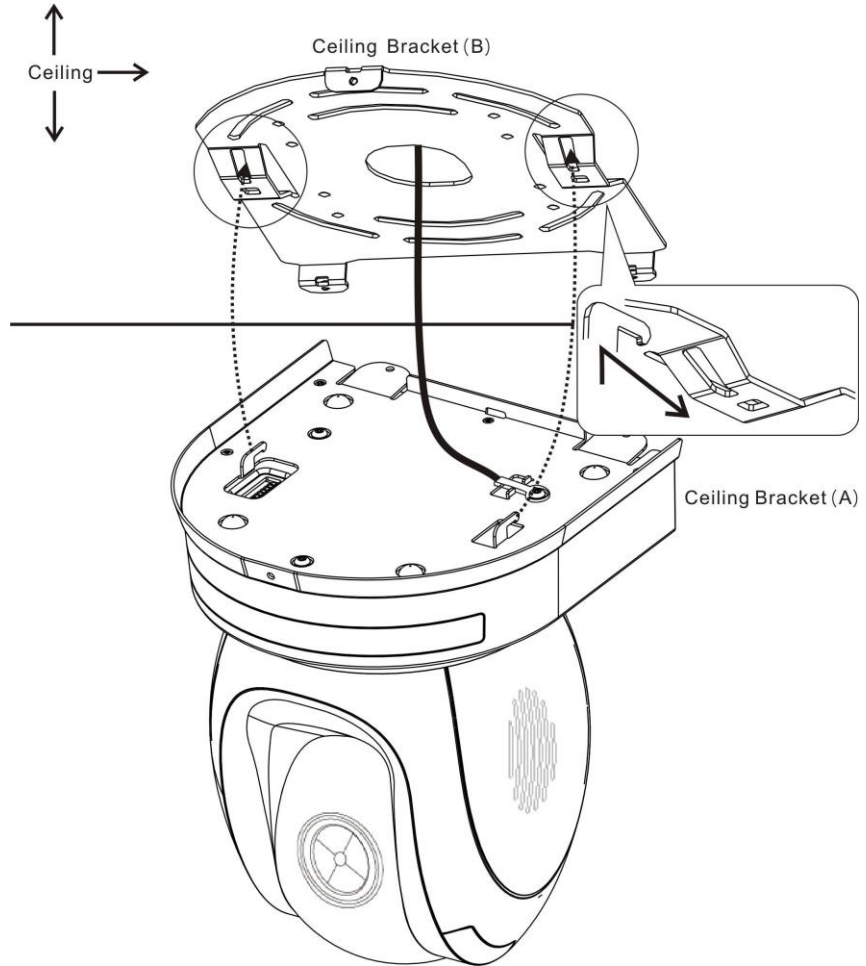

Step 6 – Screw to Secure Camera

Secure the camera by screwing three screws into the corresponding screw holes as shown in the diagram below.

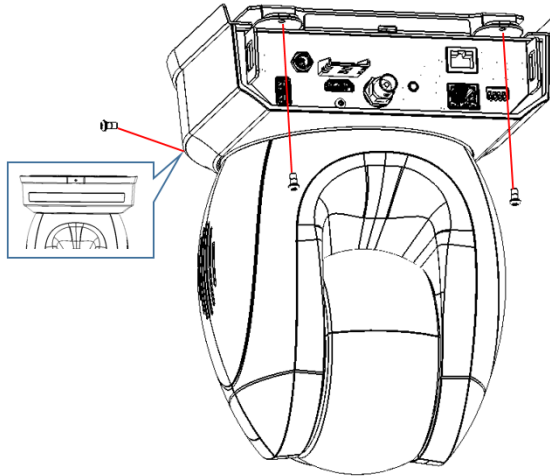

Step 7 – Cable Connection

Connect the cables to the connectors located on the rear of the camera.

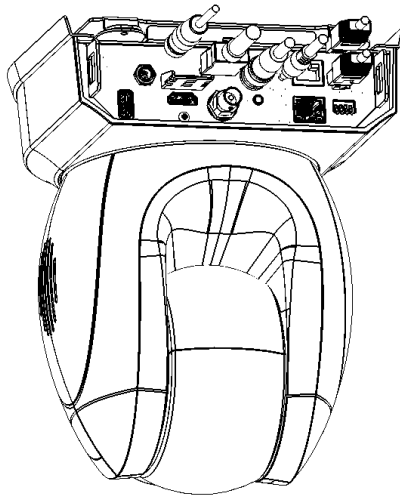

4. Network Connection

The HDBaseT port on the back panel of your PTC-285T allows you to connect a PC/laptop to the camera via the HBT-16 receiver box with a static or dynamic IP address. To access and modify these network settings, you will need to log in to the camera's web interface.

If this is your first time using the device, please note that the camera's default connection mode is DHCP.

In this chapter, we will show you how to use the web UI to enable DHCP and Static IP address modes in two separate sections.

DHCP Mode

Dynamic Host Configuration Protocol (DHCP) is a network protocol that enables a server to allocate an IP address to a DHCP client device from defined IP address pools configured for a given network. An example DHCP server setup is illustrated in the diagram below.

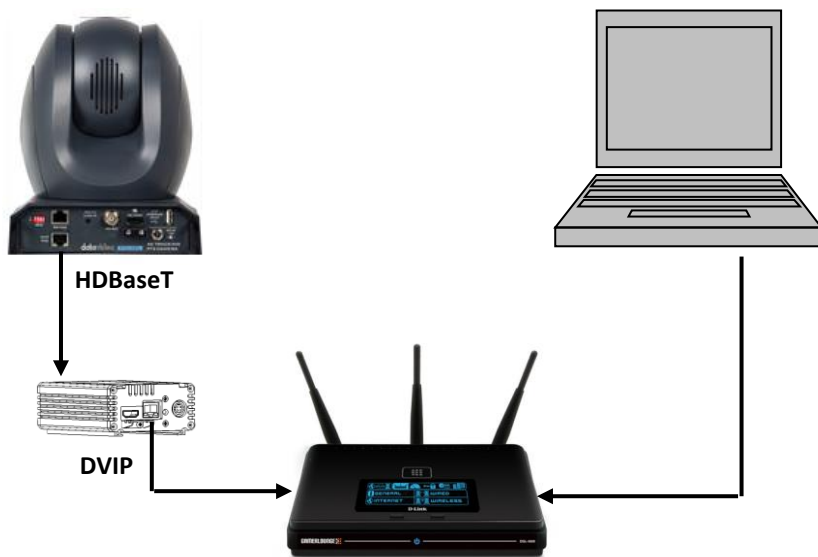

After connection has been successfully established, on your PC/laptop, use DVIP Configuration Tool to search for the camera's IP address. If you are new to DVIP, see the [DVIP](#) section for more descriptions of the tool.

Open a web browser and in the address bar, enter the camera's IP address then press the **ENTER** key which should take you to login page of the web interface.

The default login credentials are:

- User Name: admin
- Password: admin

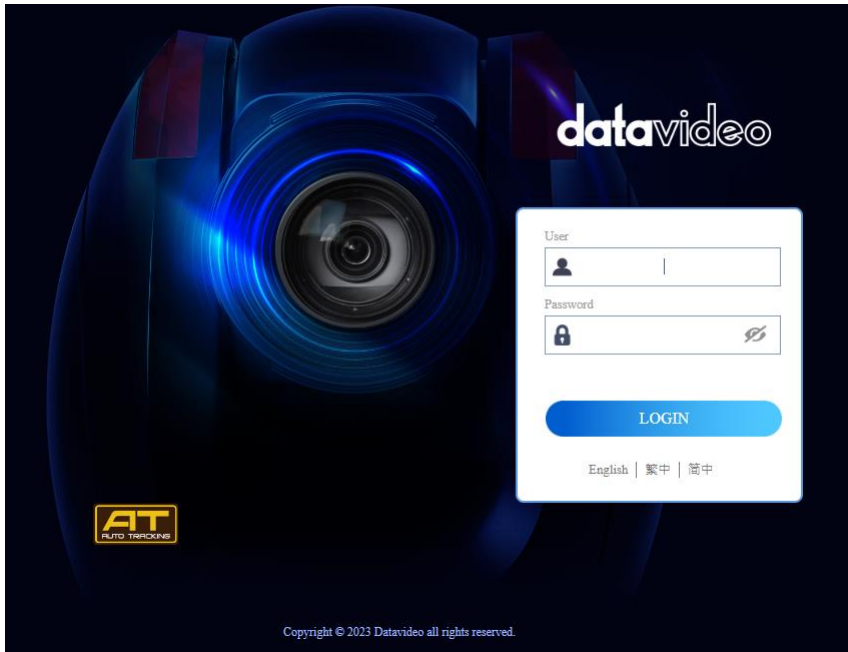

Once you are logged in, open the Network page to modify the network settings accordingly.

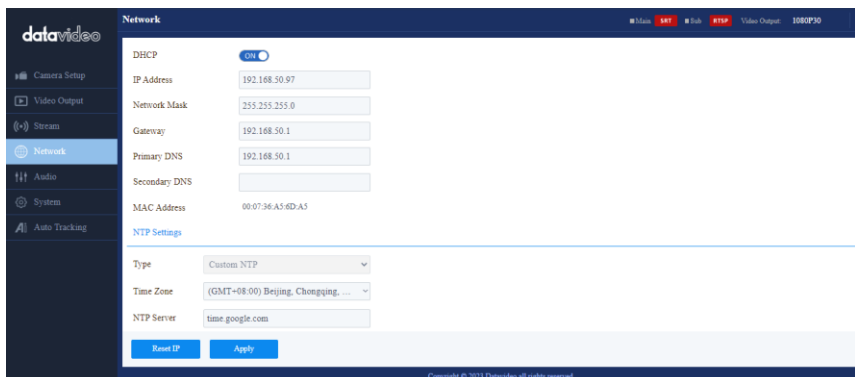

Static IP

A static IP address is a fixed address manually assigned to PTC-285T. First disable DHCP mode then enter an IP address for the camera, as well as the subnet mask and the gateway IP.

Note: Never assign an address that ends in .0 or .255 as these addresses are typically reserved for network protocols. An address to the very start of the IP pool is also not recommended as it is always reserved for the router.

After you've configured the camera's static IP mode, click the "Apply" button to save the new settings then reboot PTC-285T.

Now set up direct connection between the camera and your PC/laptop via the HBT-16 receiver box as depicted in the diagram below; remember to manually assign an IP address to your PC/laptop. The first three octets of the IP addresses should be the same.

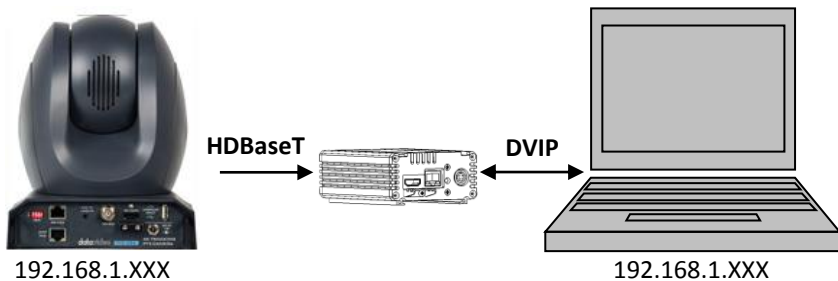

DVIP

DVIP is an Ethernet-based protocol designed by Datavideo to connect a network of Datavideo devices. DVIP Configuration Tool is a special network configuration software tool designed for DVIP device search on the same network and configuring device network settings such as Hostname, DHCP mode, IP address, subnet mask, gateway IP, and primary and secondary DNS.

Depending on your operating system, download DVIP Configuration Tool from the respective sites listed as follows:

PC: <https://www.microsoft.com/en-us/p/dvip-network-config/9p6gtz839k6s?activetab=pivot%3Aoverviewtab>

Android:

https://play.google.com/store/apps/details?id=com.datavideo.dvipnetconfig&hl=en_US

iOS: <https://itunes.apple.com/tw/app/dvip-network-config/id1177895983?mt=8>

After you've installed the DVIP Network Configuration Tool, follow the steps outlined below to scan for online DVIP devices and configure their corresponding settings.

Step 1: Open the DVIP Network Configuration Tool then select your PC or laptop's network interface card from the drop-down menu in the pop-up window as shown in the diagram below.



Step 2: The DVIP Network Configuration Tool interface is shown below and you should see a list of the connected cameras.

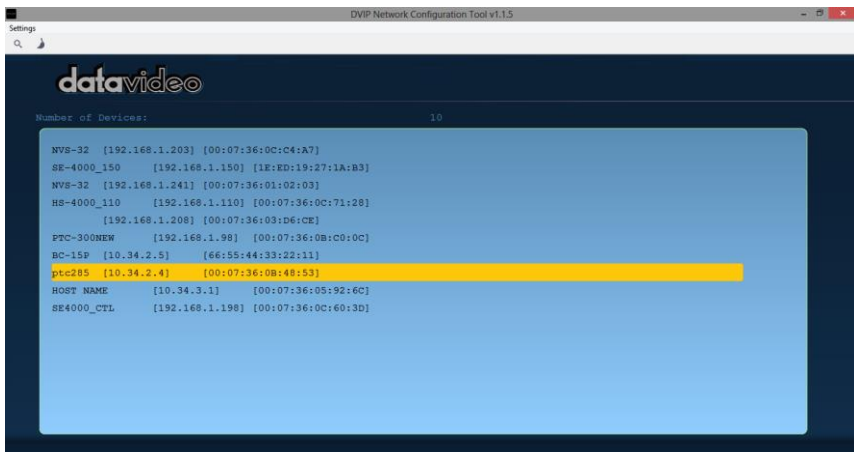

Step 3: Click one of the connected cameras to show the device information and its network settings in the pop-up window shown in the diagram below.

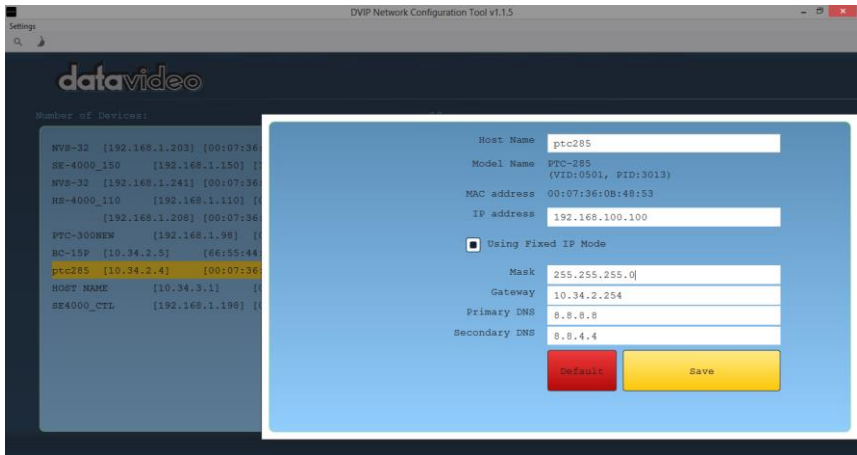

Step 4: You are allowed to change the device name in the Host Name field and modify the device's network settings accordingly. Click the Save button to confirm the change. To reset, simply click the Default button.

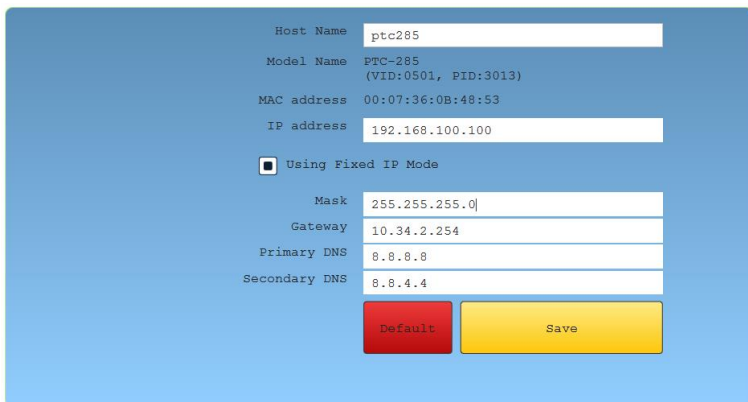

5. Basic Setup

Power-On Initialization

As shown in the diagram below, after you plug in the power cord, the tally light in the front, depending on your tally setting, will start flashing red, green or a mix of both and will be OFF as soon as the power-on initialization is complete. Please note that the power-on initialization should not take more than 45 seconds before the camera image is shown on the connected monitor. If this is your first time using the camera, the camera head should be at the HOME position with the lens facing front. If the camera has been used before, the camera head should be at the position right before the camera is shut down the last time.

Note: Use the [OSD menu](#) or [web UI](#) to select the tally light color.



Connect the DC 12 V power adapter

Video Output

You are allowed to view the camera video via **DVIP**, **4K HDMI OUT** and **3G-SDI OUT**.

HDBaseT/POE Port

HDBaseT is a connectivity technology and standard that enables the transmission of uncompressed high-definition video, audio, power, and control signals over a single Cat6A Ethernet cable.



Follow the instructions below to view the camera video on the web user interface.

Connect the PTC-285T camera to your PC/Notebook PC over a network

1. With Ethernet cables, connect the PTC-285T via the HBT-16 receiver box to a router (HDBaseT to camera and DVIP to router).

Note: The PTC-285T's default connection mode is DHCP.

2. Connect a PC/Notebook to the same router. On the PC/Notebook, open the DVIP Network Configuration Tool and search for the PTC-285T then on a web browser, enter the camera's IP address into the address bar.
3. On the login page, enter the default username and password which are admin/admin respectively.
4. Once logged in, you should be able to see a preview window on which the video is shown.

Connect the PTC-285T camera directly to your PC/Notebook PC

1. While still connected to the PTC-285T via a router in DHCP mode, open the camera's web UI on the PC/Notebook then the network page.
2. Disable DHCP then enter a static address in the **IP Address** textbox. Remember to enter a network mask and the rest are simply optional.
3. Do the same thing to your PC/Notebook. Make sure both IP addresses have the same first three octets.
4. Now connect the PTC-285T via the HBT-16 receiver box to the PC/Notebook using Ethernet cables (HDBaseT to camera and DVIP to PC/Notebook).
5. On your PC/Notebook, open the web browser and enter the camera's static IP address into the address bar.
6. On the Login page enter the default username and password which are admin/admin respectively.
7. Once logged in, you should be able to see a preview window on which the video is shown.

HDMI Video OUT

Connect the 4K HDMI OUT to an external monitor using an HDMI cable.



3G-SDI Video Output

Connect the 3G-SDI OUT to an external monitor using an SDI cable.









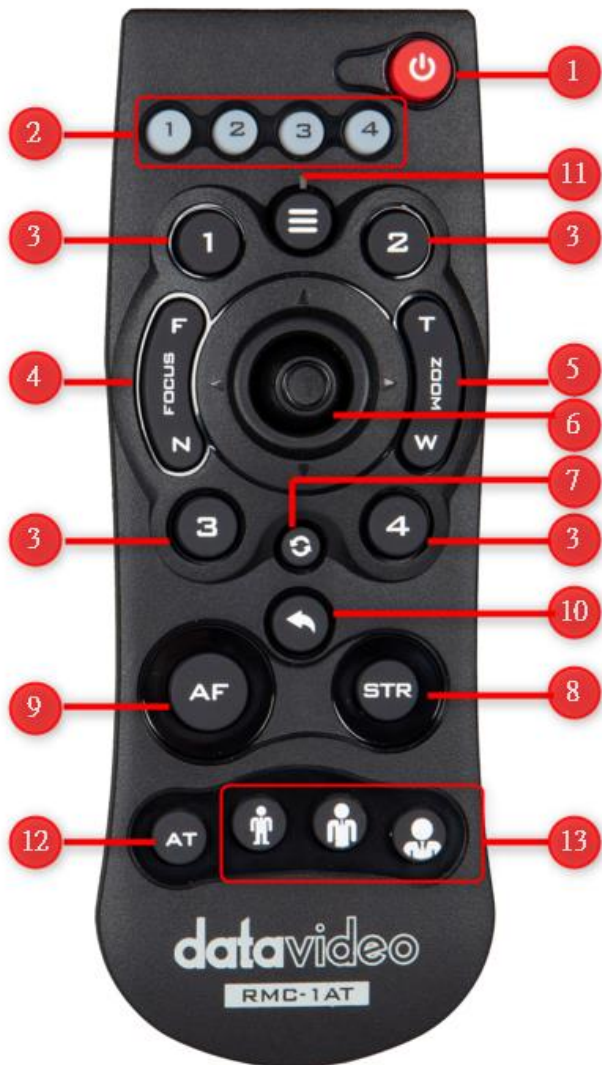

6. IR Remote Control and On-Screen Menu





Chapter 6 provides an overview of remote control functions and the OSD menu.

IR Remote Control



No	Function Keys	Descriptions
1		<p>Power Button Press to switch between Standby and Operation modes.</p> <p>Note: The power consumption in Standby Mode is approximately half of the power consumption in Operation Mode.</p>
2		<p>Camera Select Keys 1-4 In a multi-camera environment, use the camera select keys (CAM1 – CAM4) to navigate between the four cameras. Use the IRID DIP Switch to assign an ID number from 1 to 4 to the cameras intended for operation.</p> <p>The IRID DIP switch can be found on the rear panel of the camera.</p>  <p>Toggle switches 1 and 2 on/off according to one of the combinations listed below to assign an ID number to the camera.</p> <p>(1,2) = (0,0) CAM1 (1,2) = (1,0) CAM2 (1,2) = (0,1) CAM3 (1,2) = (1,1) CAM4</p> <p>Note: Switches 3/4 should be always OFF.</p>
3		<p>Preset Keys 1 – 4 Use the preset keys to save and recall PTZ settings.</p> <p>Saving to the Preset Key: First configure the camera's focus, zoom, pan and tilt settings, then press the STR key followed by one of the preset keys to save to the selected preset.</p> <p>Recalling the Preset: Simply press one of the preset keys to load the settings saved therein.</p>

No	Function Keys	Descriptions
4		<p>Focus Button Auto focus will be disabled as the Focus button (either F or N) is pressed. Press F to focus on a far object and N to focus on a near object.</p> <p>Note: You can also adjust the focus using the web UI. See Focus for more details.</p>
5		<p>Zoom Button The zoom function adjusts the size of the image. Press T (telephoto lens) to zoom in on a subject from far away and W (wide-angled lens) to zoom out.</p> <p>Note: You can also adjust the zoom using the web UI. See Zoom for more details.</p>
6		<p>PT Joystick Use the joystick to pan and tilt the camera head. Press the up and down arrow keys to tilt; press the left and right arrow keys to pan.</p> <p>While the OSD menu is opened, press the up and down keys to move between options. Press the right and left keys to toggle between values. Press the center button to enter a sub menu or confirm a selection. To exit a sub menu, press the MENU or Back button.</p>
7		<p>Reset IP Button Press and hold for about 3 seconds to reset the camera's network settings to DHCP.</p> <p>Note: If there is no DHCP server on your network, the camera will use static IP to connect after the reset. The default IP address is 192.168.100.100.</p>
8		<p>STR Button Use the STR button along with the preset keys to save the PTZ settings. See Preset Keys 1 – 4 for more information.</p>

No	Function Keys	Descriptions
9		<p>AF Button Press to enable Auto Focus.</p>
10		<p>Back Button Press to return the camera head to its default position. When the OSD menu is opened, press to return to the previous item on the menu.</p>
11		<p>MENU Button Press the “MENU” button to open the OSD menu on the connected monitor. See OSD Menu for descriptions of various menu options.</p>
12		<p>AT Button Press to enable auto-tracking.</p> <p>Note: Once auto-tracking is enabled, the message “Start Tracking” should appear on the monitor showing the camera video. See Auto-Tracking for various relevant settings.</p>
13		<p>Auto-Tracking Mode Selection Buttons From left to right, these three buttons select, in the respective order, full body, half body and close-up framing.</p>

OSD Menu

On-Screen Menu allows the user to modify various camera settings. Press **[MENU]** on the **remote control** to open the on-screen menu as shown below.

OSD Menu
Exposure
Color
Image
P/T/Z
Noise Reduction
Setup
Communication Setup
Information
Restore Default

【Home】 Enter

【Menu】 Exit

The table below summarizes the main option items and their sub-options.

Main Options									
Exposure	Color	Image	P/T/Z	Noise Reduction	Setup	Communication Setup	Information	Restore Default	
Sub-Options	Mode	WB Mode	Luminance	SpeedByZoom	NR3D-Level	Language	Protocol	ARM	Restore?
	ExpComp Mode	RG Tuning	Contrast	AF-Zone		HDMI RGB Mode	V_Address	SOC	
	Backlight	BG Tuning	Sharpness	AF-Sense		Video Format	V_AddrFix	Date	
	Gain Limit	Saturation	Flip-H	L/R Set		Audio Select	Net Mode	AF	
	Anti-Flicker	Hue	Flip-V	Display Info		SDI-3G Mode	Baudrate	Format	
	Meter	RG	B&W-Mode	Image Freeze		USB UPGRADE		Model	
	DRC	BG	Style	Digital Zoom		VISCA ID		IP	
	Iris	Color Temp		Pre Speed		Audio Channel		GateWay	
	Shutter			Pre Zoom Speed				NetMask	
	Gain							CTRL SRC	
	Bright								

Details of all options in the on-screen menu are listed in the table below.

Main Menu	Sub Menu	Options		Descriptions
Exposure	Mode	Auto		See Exposure
		Manual		
		SAE		
		AAE		
		Bright		
	ExpCompMode	Off		Exposure Compensation Mode; See Exposure
		On		
	Backlight	Off		Backlight Compensation Mode; See Exposure
		On		
	Gain Limit	0 – 22; Step Size: 1		See Exposure
	Anti-Flicker	Off		See Advanced Image Settings
		50Hz		
		60Hz		
	Meter	Average		Light Meter; See Exposure
		Center		
		Smart		
		Top		
	DRC	0 – 8; Step Size: 1		Dynamic Range Compression; See Exposure
	Iris	F1.8		Accessible when exposure mode is set to Auto, Manual and AAE; See Exposure
		F2.0		
		F2.4		
		F2.8		
		F3.4		
		F4.0		
		F4.8		
		F5.6		
		F6.8		
F8.0				
F9.6				
F11.0				
Close				
Shutter	NTSC Shutter	PAL Shutter		Shutter speed; See Exposure
	1/30	1/25		
	1/60	1/50		
	1/90	1/75		
	1/100	1/100		
	1/125	1/120		
	1/180	1/150		
	1/250	1/250		
	1/350	1/350		
	1/500	1/500		
	1/725	1/725		
	1/1000	1/1000		
	1/1500	1/1500		
	1/2000	1/2000		
1/3000	1/3000			

Main Menu	Sub Menu	Options		Descriptions
		1/4000	1/4000	
		1/6000	1/6000	
		1/10000	1/10000	
	Gain	0 – 22; Step Size: 1		Accessible when exposure mode is set to manual; See Exposure
Bright	0 – 17; Step Size: 1		Accessible when exposure mode is set to bright; See Exposure	
Color	WB Mode	Auto		See White Balance
		Indoor		
		Outdoor		
		OnePush		
		Manual		
		VAR		
	RG Tuning	-10 – 10; Step Size: 1		Fine tunes red gain; See Exposure
	BG Tuning	-10 – 10; Step Size: 1		Fine tunes blue gain; See Exposure
	Saturation	60 – 200%; Step Size: 10%		See Basic Image Settings
	Hue	0 – 14; Step Size: 1		See Basic Image Settings
RG	0 – 255		Red gain; See Exposure	
BG	0 – 255		Blue gain; See Exposure	
Color Temp	2500 – 8000K; Step Size: 100		Color temperature; See Exposure	
Image	Luminance	0 – 14; Step Size: 1		See Basic Image Settings
	Contrast	0 – 14; Step Size: 1		See Basic Image Settings
	Sharpness	Auto		See Basic Image Settings
		0 – 15; Step Size: 1		
	Flip-H	Off		When enabled, the camera video image will be flipped horizontally.
		On		
	Flip-V	Off		When enabled, the camera video image will be flipped vertically.
		On		
	B&W-Mode	Off		Black and White mode
		On		
Style	Default			
	Norm			
	Bright			
	PC			
P/T/Z	SpeedByZoom	Off		Pan and tilt speed as a function of zoom once enabled. The PTZ speed should increase and decrease gradually.
		On		

Main Menu	Sub Menu	Options	Descriptions
	AF-Zone	Front	Set auto focus to front, center, top or bottom area.
		Top	
		Center	
		Bottom	
	AF-Sense	High	Auto focus sensitivity
		Low	
		Normal	
	L/R Set	STD	Standard PAN direction
		REV	Reversing the PAN direction; usually selected when the camera is hung on the ceiling or installed upside down.
	Display Info	Off	PTZ info display
		On	
	Image Freeze	On	Once enabled, the image will be frozen when recalling a preset and the image should resume after the camera head is moved to the recalled position.
		Off	
Digital Zoom	Off		
	2x		
	4x		
	8x		
	16x		
Pre Speed	1 – 24; Step Size: 1	Adjust the P/T speed	
Pre Zoom Speed	0 – 7; Step Size: 1	Adjust the zoom speed.	
Noise Reduction	NR3D-Level	Auto	See Advanced Image Settings .
		Off	
		1 – 8; Step Size: 1	
Setup	Language	Traditional Chinese	OSD menu language
		EN	
		Simplified Chinese	
	HDMI RGB Mode	HDMI	Note: DVI Mode is NOT available for 4K50/59/60
		DVI	
	Video Format	1080P25	These are the available camera video resolutions which can also be found in the Resolution pull-down menu on the Video Output page of the web UI.
		720P50	
		1080P60	
		1080P50	
		1080I60	
		1080I50	
		1080P30	
		720P60	
1080P29.97			
1080I59.94			
1080P59.94			

Main Menu	Sub Menu	Options	Descriptions
		720P59.94	
		4KP29.97	
		4KP59.94	
		4KP25	
		4KP30	
		4KP50	
		4KP60	
	Audio Select	MIC	See Audio Input
		LINE IN	
	SDI-3G Mode	LEVEL-A	Level-A or Level-B mapping
		LEVEL-B	
	USB UPGRADE	Off	USB FW Upgrade
		On	
	VISCA ID	By DIP	Assign VISCA ID using DIP switch or OSD menu
By OSD			
Audio Channel	Stereo	See Soundtrack	
	Mono		
Communication Setup	Protocol	VISCA	Select the control protocol
		PELCO-D	
		PELCO-P	
		Auto	
	V_Address	1	Set VISCA ID for daisy chain of cameras
	V_AddrFix	Off	VISCA address will be fixed when enabled.
		On	
	Net Mode	Serial	
		Paral	
	Baudrate	38400	Select a baud rate for the protocol selected.
2400			
4800			
9600			
Information	ARM	Firmware information	
	SOC		
	Date		
	AF		
	Format		
	Model	Model number	
	IP	Network information	
	GateWay		
	NetMask		
CTRL SRC			
Restore Default	Restore?	Yes/No	Factory reset

7. Web User Interface

The web based user interface allows you to set and control your PTC-285T devices. On any browser, enter the camera's IP address then hit the Enter key, after which you should be taken to the login page. The default login credentials are admin/admin. Please note that the password can be changed later.

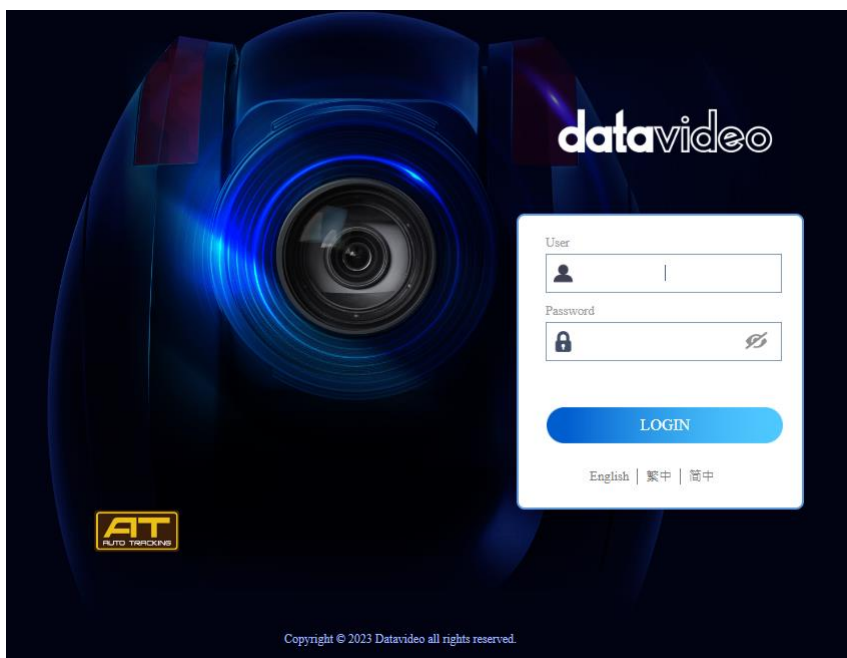

Please note that in order to access the web UI, your PC needs to be connected to the camera via the DVIP interface. See [Network Connection](#) to connect.

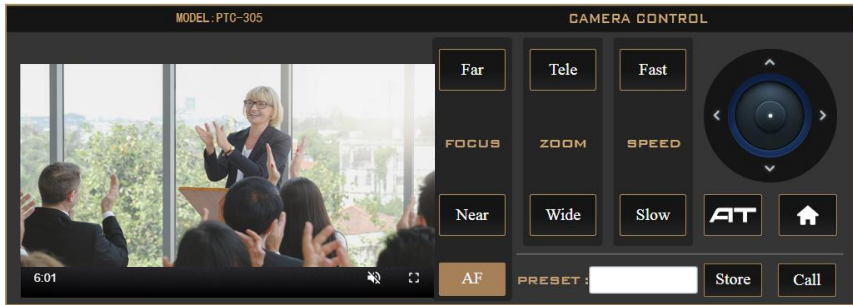

Camera Control

Once logged in to the web UI, you will be able to find the control panel shown below in [Camera Setup](#) and [Auto-Tracking](#).



A preview window is positioned in the left half of the panel, allowing you to view the live camera video. Elapsed time is shown in the bottom left corner of the window. At the bottom right corner, click  to enable sound. Use the sound slider that appears to adjust the volume accordingly. Click  to view the video in full screen.

On the right half, you will find various camera control options described as follows:

Focus

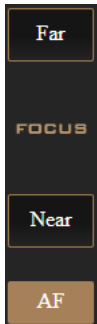

You can focus on objects at varying distances by adjusting its focal length to bring both near and far subjects into sharp focus. Click **Far** to focus on a far object and **Near** to focus on a near object.

You can also enable **Auto Focus** by clicking the AF button, allowing the camera to automatically set the focus on the center of the image.

Zoom

The zoom function adjusts the size of the image. Click Tele (telephoto lens) to zoom in on a subject from far away and Wide (wide-angled lens) to zoom out.



Pan and Tilt



Use the up/down arrows to tilt the camera head up and down and the left/right arrows to pan the camera head left and right. You can simply hover the mouse cursor over these arrow buttons.

Speed



Click the **Fast/Slow** buttons to increase/decrease the pan, tilt and zoom speed.

AT

Click the **AT** button to enable auto-tracking. Auto-tracking detects motion of objects and use the PTZ to follow it. See [Auto-Tracking](#) for in-depth setup.



Home



Click the **Home** button to return the PTZ position to the default settings.

Presets

There are 255 memory presets where you can save the PTZ and focus settings to. First enter a preset number (0 – 254) in the **PRESET** textbox then click the **Store** button to save the current PTZ and focus settings to the selected preset position. To access a preset position, simply enter the number in the **PRESET** textbox then click the **Call** button.



Camera Setup

In Camera Setup, you will be able to find various settings for the camera video. These options will be described in detail in this section.

Basic Image Settings (Page 1)

Contrast

Adjust image contrast from 0 – 14.

Brightness

Adjust image brightness from 0 – 17.

Saturation

Adjust image saturation from 60 – 200%.

Note: The higher the saturation, the more vivid the colors will be.

Hue

Adjust image hue from 0 – 14.

Sharpness

Adjust image sharpness from 0 – 11.

Exposure (Page 1)

Exposure modes are listed as follows:

Auto – Fully automatic settings for shutter speed and aperture with ability to adjust gain, dynamic range, backlight and anti-flicker.

Manual – Full iris, shutter speed and range control

Shutter Automatic Exposure – The camera will measure light and automatically set the aperture based on the selected shutter speed.

Aperture Automatic Exposure – The camera will measure light and automatically set the shutter speed based on the selected iris opening (aperture).

Bright – Manual adjustment of the brightness level.

Please note that every exposure mode has different settings. The table below summarizes the correlated settings of all exposure modes.

	Auto	Manual	SAE	AAE	Bright
Gain Limit	√		√	√	√
Shutter		√	√		

ExpCompMode	√				
Backlight	√				
Meter	√		√	√	√
DRC	√	√	√	√	√
Bright					√
Iris	√	√		√	
Gain		√			

Gain Limit

Setting the gain limit allows you to cap the maximum gain to a value in the range of 1 – 22.

Accessible when **Exposure Mode** is set to **Auto**, **SAE**, **AAE**, and **Bright**.

Shutter

Select shutter speed from the drop-down menu.

1/30, 1/60, 1/90, 1/100, 1/125, 1/180, 1/250, 1/350, 1/500, 1/725, 1/1000, 1/1500, 1/2000, 1/3000, 1/4000, 1/6000, 1/10000

Accessible when **Exposure Mode** is set to **Manual** and **SAE**.

ExpCompMode

This is the **Exposure Compensation Mode**, which, when enabled, corrects brightness of an image whose exposure is already automatically adjusted.

Accessible when **Exposure Mode** is set to **Auto**.

Backlight

This is the Backlight Compensation Mode, which, when enabled, optimizes exposure for backlight.

Accessible when **Exposure Mode** is set to **Auto**.

Meter

A light meter is a tool that evaluates the amount of light reflected by a scene to set the aperture and/or shutter speed to achieve the perfect exposure. The light meter can function in following modes.

- Average: Measures the average brightness of the entire scene, while emphasizing the central area.
- Center: Measures only the central area.
- Smart: Measures light on each area after dividing the total scene area into multiple areas and determines the proper exposure of the entire scene.

- Top: Measures the top area.

DRC

DRC sets the amount of Dynamic Range Compression where higher values lead to more compression (**1 – 8** or **off**).

Bright

Bright sets the brightness level from 0 to 14.

Accessible when **Exposure Mode** is set to **Bright**.

Iris

The Iris drop down menu allows you to select the iris setting from the list below:

F1.8, F2.0, F2.4, F2.8, F3.4, F4.0, F4.8, F5.6, F6.8, F8.0, F9.6, F11.0

Accessible when **Exposure Mode** is set to **Auto, Manual** and **AAE**.

Gain

The Gain can be adjusted from 0 to 14.

Accessible when **Exposure Mode** is set to **Manual**.

White Balance (Page 1)

Auto: When Auto is chosen, you are allowing the camera to constantly read the tones in your scene and set the brightest part of your image as the white point. You will be allowed to fine tune red and blue gains in this mode.

Indoor: For indoor video production.

Outdoor: For outdoor video production.

Manual: In this mode, you will allowed to manually set the camera's white balance by adjusting red and blue gains.

OnePush: One time auto white balance. You will be allowed to fine tune red and blue gains in this mode.

VAR: Select VAR if you would like to manually adjust color temperature in addition to fine tuning red and blue gains.

RG Tuning

This fine tunes red gain from **-10 to 10**.

Accessible when **White Balance** is set to **Auto, OnePush** and **VAR**.

BGTuning

This fine tunes blue gain from **-10 to 10**.

Accessible when **White Balance** is set to **Auto, OnePush** and **VAR**.

RGain

RGain sets intensity of red color from 0 to 225.

Accessible when **White Balance** is set to **Manual**.

BGain

BGain sets intensity of blue color from 0 to 225.

Accessible when **White Balance** is set to **Manual**.

Colortemp

Color temperature measures the physical property of light in Kelvin (K), ranging from 2500K to 8000K with a step size of 100. It varies between different light sources.

The following table is a rule-of-thumb guide to the correlated color temperature of some common light sources.

Color Temperature	Light Source
1000 – 2000 K	Candlelight
2500 – 3500 K	Tungsten Bulb (household variety)
3000 – 4000 K	Sunrise/Sunset (clear sky)
4000 – 5000 K	Fluorescent Lamps
5000 – 5500 K	Electronic Flash
5000 – 6500 K	Daylight with Clear Sky (sun overhead)
6500 – 8000 K	Moderately Overcast Sky
9000 – 10000 K	Shade or Heavily Overcast Sky

Accessible when **VAR** is selected.

Advanced Image Settings (Page 2)

Gamma

Enable gamma correction for more natural look of images and the ability to differentiate between dark tones in a darker images.

Mirror

The mirror function (Flip-H) flips the camera video image horizontally, and the flip function (Flip-V) does it otherwise. You can turn either or both of them on. Select the right combination from the drop-down menu.

- Mirror Off/Flip Off
- Mirror On/Flip Off
- Mirror Off/Flip On
- Mirror On/Flip On

Anti-Flicker

To avoid video flicker, you can set your camera flicker frequency to **50 Hz** or **60 Hz**.

AGC

Also known as **Automatic Gain Control**. Enable AGC in low-light conditions.

3DNR

3D noise reduction is applied in static areas of the field of view.

- OFF
- 1 – 8
- Auto

WDR

Also known as wide dynamic range, often used in situations where there is a large difference in foreground and background light levels.

Video Output

As shown in the diagram below, select a resolution for the camera video.

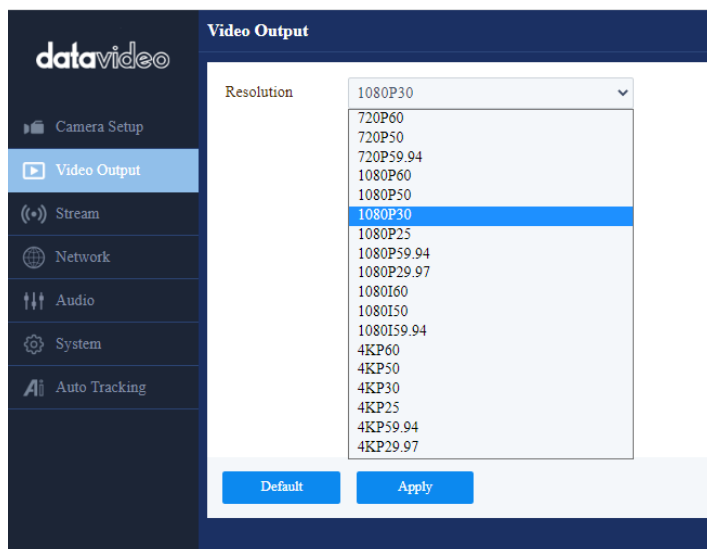

Stream

In this section, we will first show you all common streaming setup options then the settings specific to the respective streaming protocols.

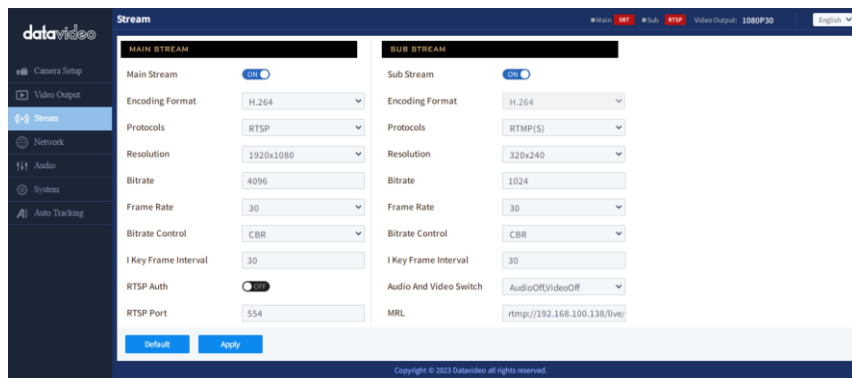

Encoding Format

First select either the H.264 or H.265 video codec after you've turned on the streaming server (main or sub).

If you're working with high-resolution video formats such as 4K and 8K, H.265 is the better choice due to its improved compression efficiency. However, if you're working with older devices or platforms that may not support H.265, or if you're streaming video over a limited bandwidth connection, H.264 may be the better option.

Protocol

Each streaming server offers the user multiple stream types. There are **RTSP Multicast, RTSP, RTMP(S), SRT and Onvif**.

Please note that when streaming, the server converts video into data, which are sent across an IP network. High bitrates consume more bandwidth across the IP network. In a gigabit office LAN, high bitrates may not be a concern and Speed/Bandwidth is therefore not a limitation.

If your available bandwidth is limited, you should reduce both your resolution and your bitrate accordingly. A good rule of thumb is for the bitrate of your stream to use no more than 50% of your available upload bandwidth capacity on a dedicated line. For example, if the result you get from a speed test shows that you have 20Mbps of upload speed available, your combined audio and video bitrate should not exceed 10Mbps.

Resolution

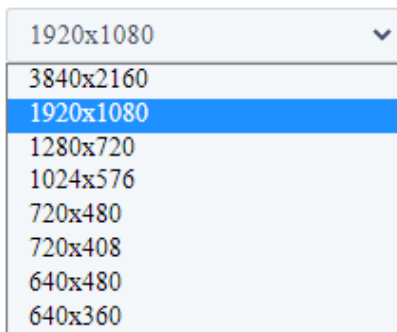
A dropdown menu showing resolution options. The current selection is 1920x1080, which is highlighted in blue. Other options listed are 3840x2160, 1280x720, 1024x576, 720x480, 720x408, 640x480, and 640x360.

1920x1080	▼
3840x2160	
1920x1080	
1280x720	
1024x576	
720x480	
720x408	
640x480	
640x360	

Adjusting the image size is a critical step of encoder setup. It is best to either match your original video source or scale it down. For example, capture at HD 720 and stream at HD 720. Or capture at 4K 2160 and stream at Full HD 1080.

You should never be scaling up and streaming at a higher resolution than your original video source. For example, it does not make sense to capture at 720 and stream at 1080. Note that you will also have no gain in quality and you are using more bandwidth than is necessary for your viewers.

You should also be aware that higher resolutions require greater processing power to encode the stream. Attempting too high of a resolution on too little processing power can result in degraded image quality and corrupted or interrupted streams or recordings.

Bitrate

Enter the desired video bitrate for your video stream. The recommended video bitrates to use are listed as follows:

- 4,500 to 6,000 kbps for full HD videos with a high frame rate (1080p, 60fps)
- 3,500 to 5,000 kbps for full HD videos with a standard frame rate (1080p, 30fps)
- 3,500 to 5,000 kbps for HD videos with a high frame rate (720p, 60fps)
- 2,500 to 4,000 kbps for HD videos with a standard frame rate (720p, 30fps)

Frame Rate

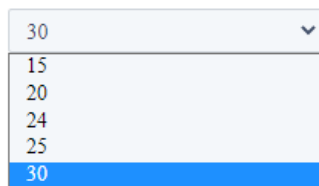
A dropdown menu showing frame rate options. The current selection is 30, which is highlighted in blue. Other options listed are 15, 20, 24, and 25.

30	▼
15	
20	
24	
25	
30	

Select a frame rate from the drop-down menu for video streaming. Note that frame rates should always match the frame rate of the video source.

Bitrate Control

There are two different bitrate types: CBR (constant) and VBR (variable). CBR is best for live streaming encoding and VBR is best for on-demand videos.

Keyframe Interval

The keyframe interval in video encoding determines how often complete frames, called keyframes, are inserted into a video sequence. For live stream, a two-second keyframe interval is optimal, so if your frame rate is 30 fps, the keyframe interval would be every 60 frames.

Note: A short keyframe interval can result in stuttered playback.

RTP Multicast

RTP allows data transfer to multiple destinations through IP multicast in IP networks. Once selected, the device will automatically generate an RTP address and a port number which are respectively 224.1.2.3 and 6688 as depicted in the diagram below. Enter **rtp://224.1.2.3:6688** into the client device to view a live video streamed from the camera via RTP multicast.

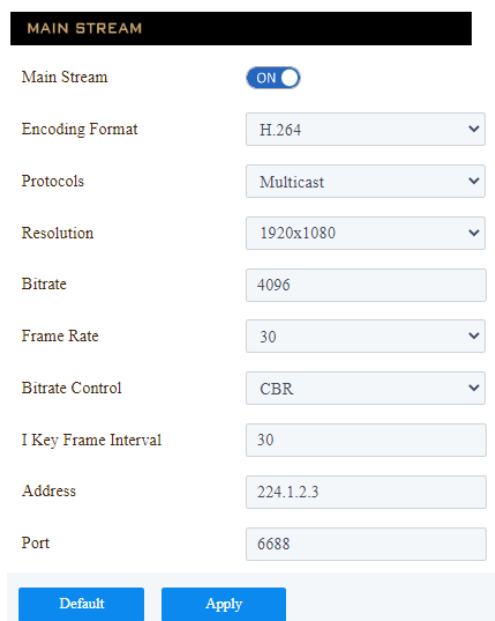

The image shows a configuration panel titled "MAIN STREAM" with the following settings:

Parameter	Value
Main Stream	ON
Encoding Format	H.264
Protocols	Multicast
Resolution	1920x1080
Bitrate	4096
Frame Rate	30
Bitrate Control	CBR
I Key Frame Interval	30
Address	224.1.2.3
Port	6688

At the bottom of the panel are two buttons: "Default" and "Apply".

It is recommended to use VLC media player to view an RTP live stream. Open VLC on your PC, then click **“Media”** → **“Open Network Stream”**.

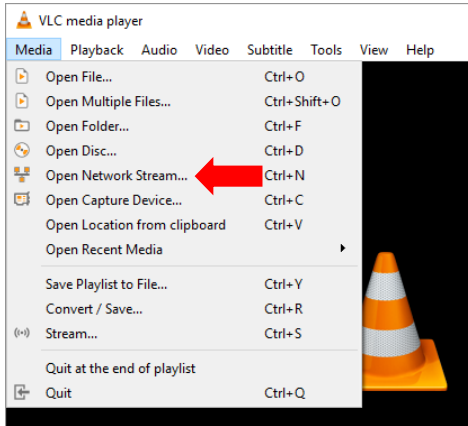

On the window that opens, enter **rtp://224.1.2.3:6688** as shown in the diagram below then click **Play** to start viewing.

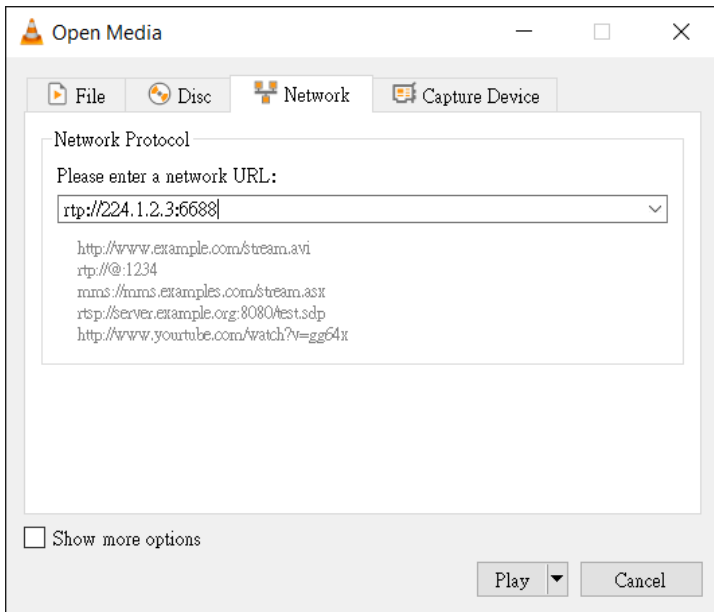

RTSP

RTSP (Real-Time Streaming Protocol) is a network protocol designed to transfer video over a network or to the internet with an easy-to-use link.

The default RTSP port number is 554. The alternate port number is 8551.

When RTSP Auth is enabled, only authorized users have access to the footage captured by the camera.

MAIN STREAM	
Main Stream	<input checked="" type="checkbox"/> ON
Encoding Format	H.264
Protocols	RTSP
Resolution	1920x1080
Bitrate	4096
Frame Rate	30
Bitrate Control	CBR
I Key Frame Interval	30
RTSP Auth	<input type="checkbox"/> OFF
RTSP Port	554

It is recommended to use VLC media player to view an RTSP live stream. Open VLC on your PC, then click “Media” → “Open Network Stream”.

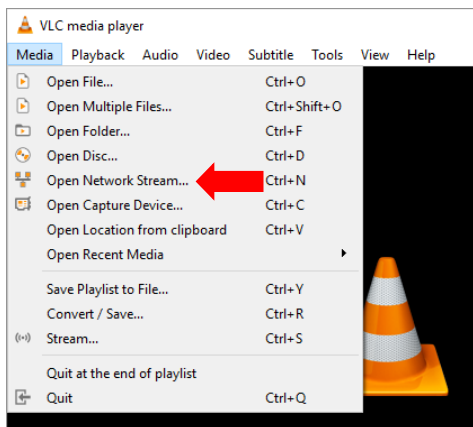

On the window that opens, enter `rtsp://IP address:554/channel number` as shown in the diagram below then click **Play** to start viewing.

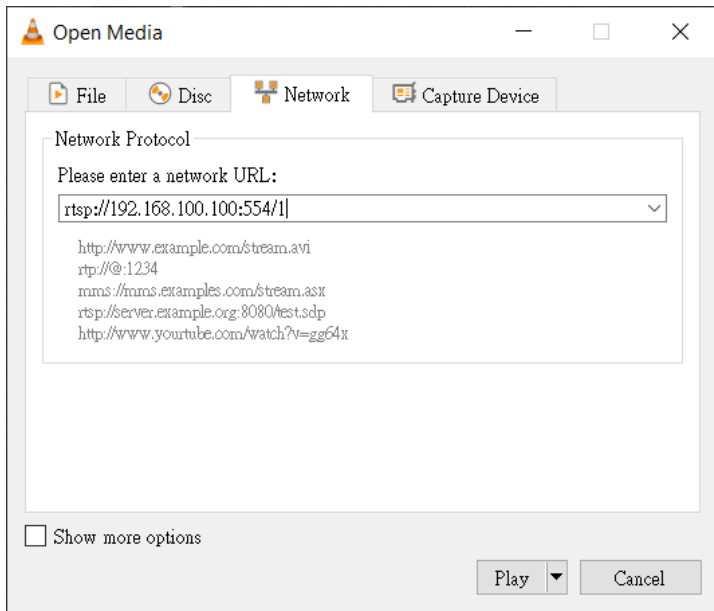

RTMP(S)

Real-Time Messaging Protocol (RTMP) is a communication protocol for streaming audio, video and data over the Internet. Use the guide in this section to learn about streaming live media and publishing streams.

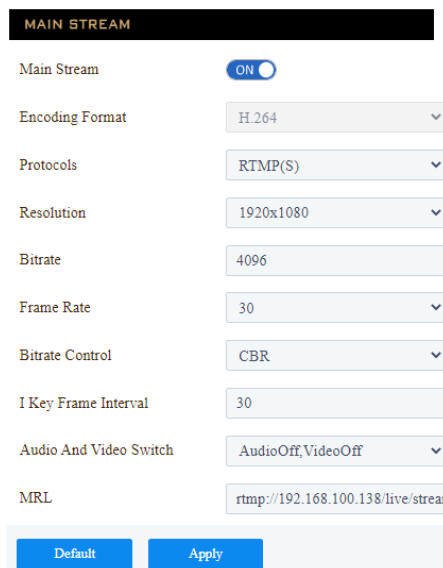

After RTMP(S) is enabled, you will see the following options:

Audio and Video Switch: In the drop-down menu, you can either turn both audio and video on/off or either one on/off.

MRL: In the textbox, enter the RTMP link (Server URL/Stream Name) to which your video will be published. The link is usually retrieved from a live streaming platform.

See the examples below to set up an **RTMP(S)** stream to **Facebook** and **Youtube**. Please note that Facebook Live limits each stream to 8 hours.

Facebook

1. Open Facebook Live by clicking the link below then click “Go Live Now”.

<https://www.facebook.com/formedia/solutions/facebook-live>



Please note that you can also link to Facebook Live from your Facebook

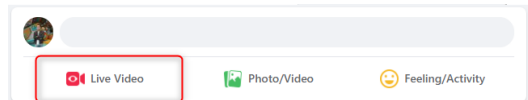



Personal Page or Facebook Fan Page by clicking “Live Video” as depicted on the right.

2. Select “Go live”.





Go live

-  Go live by yourself or with others
-  Choose where to publish your live video
-  Explore additional tools to engage your viewers

[Go live](#)



Create live video event

-  Create an event ahead of time to share with your audience
-  Viewers can RSVP to your event
-  You and your viewers will get a reminder before you go live

[Create event](#)

3. Select “Streaming software” where you will be able to find the server URL and the stream key. If you’d like, you can also enter the title and descriptions about this live stream.

Select a video source ?



Webcam



Streaming software

Preview streams via streaming software are subject to our [Community Standards](#) and Facebook Live policies, and may be retained by Facebook for review and enforcement.

Streaming software setup

Copy and paste the stream key into your streaming software.

Stream key

FB-370758482040289-0-AbwT_NpvFKtrYPK
Copy

This stream key is valid until you log out of Facebook. Once you start to preview the broadcast you have up to 4 hours to go live.

Advanced Settings ^

Persistent stream key 🔴

This can be reused every time you go live. You can only broadcast one live video at a time with your persistent stream key.

Backup stream 🔴

Once a backup stream is added to your live video, it cannot be removed. It will not affect your stream if you choose not to use it.

Server URL

rtmps://live-api-s.facebook.com
Copy
Ingest URLs

This may be referred to as "URL" or "Address" in your streaming software.



Add post details

Share to story 👍

Your live video will also be added to your story.

Title (optional)

Description

- Go back to the camera's web UI and as depicted in the diagram on the right, Enter "Server URL/Stream key" in the MRL textbox. In this example, we use the link retrieved at step 3, which is **rtmps://live-api-s.facebook.com:443/rtmp/FB-370758482040289-0-AbwT_NpvFKtprYPK**.

MAIN STREAM

Main Stream

Encoding Format H.264

Protocols RTMP(S)

Resolution 1920x1080

Bitrate 4096

Frame Rate 30

Bitrate Control CBR

I Key Frame Interval 30

Audio And Video Switch AudioOn,VideoOn

MRL rtmps://live-api-s.facebook.com:443/rtmp/FB-370758482040289-0-AbwT_NpvFKtprYPK

Default Apply

- Click the **Apply** button to activate the RTMP video stream. Make sure both audio and video are enabled.

✓ Data Update Successful

The RTMP video stream is successfully activated when you see "Data Update

Successful" appear at the bottom of the UI.

At the top right corner of the web UI, you should see that the main stream channel is now switched to RTMP(S) mode.

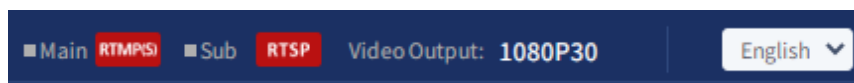

- As shown in the diagram below, you can also preview the live camera video on Facebook Live.

Select a video source ?

Webcam

Streaming software

Preview streams via streaming software are subject to our [Community Standards](#) and Facebook Live policies, and may be retained by Facebook for review and enforcement.

Streaming software setup

Copy and paste the stream key into your streaming software.

Stream key

FB-370758482040289-0-AbwT_NpvFKtprYPK Copy

This stream key is valid until you log out of Facebook. Once you start to preview the broadcast you have up to 4 hours to go live.

Advanced Settings ∨

Video

Expand video ∨

📄 Event logs

Add post details

Share to story ☑

Your live video will also be added to your story.

Title (optional)

Description 😊

👤 📍 😊

- Before you activate the live stream on Facebook, on the left pane of Facebook Live, choose where and when you want to post your live video as well as the audience. Lastly, click the “Go live” button to start livestreaming of your camera video on Facebook.

Video ∨

LIVE

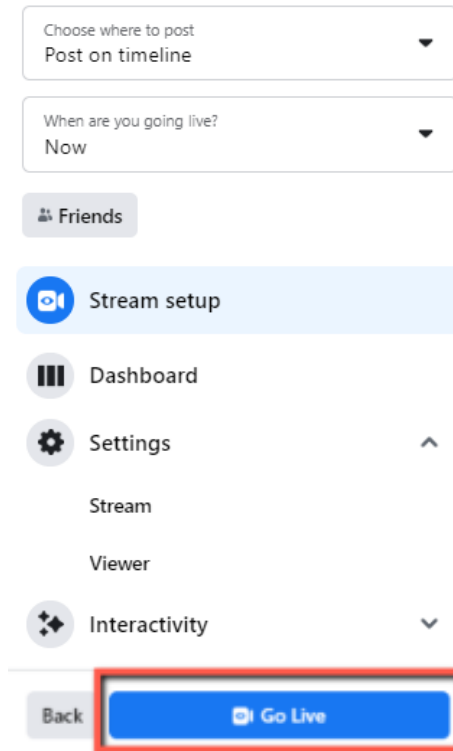

8. To end the live stream, simply click “End Live Video”.

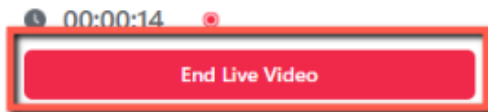

Youtube

1. Open the Youtube Live Control Room by clicking the link below:
https://www.youtube.com/live_dashboard
Alternatively, log in to your Youtube account, locate and click the camera icon at the top right corner, then select “Go live”.

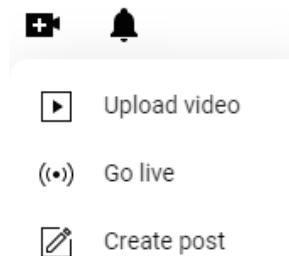

- If this is your first time using **Youtube Live Control Room**, select “**Right Now**” on the pop-up prompt.

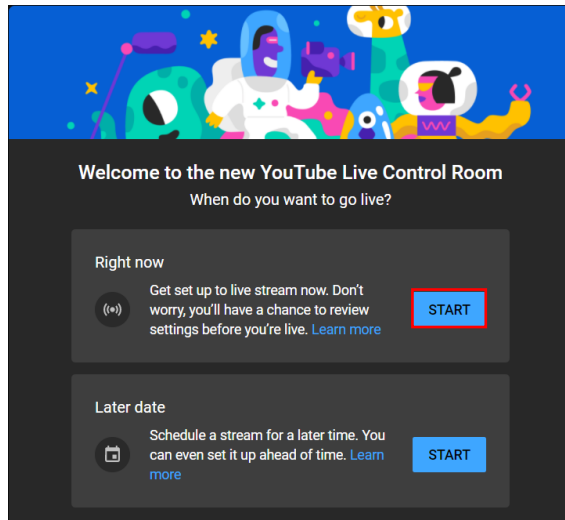

- Select **Streaming Software**.

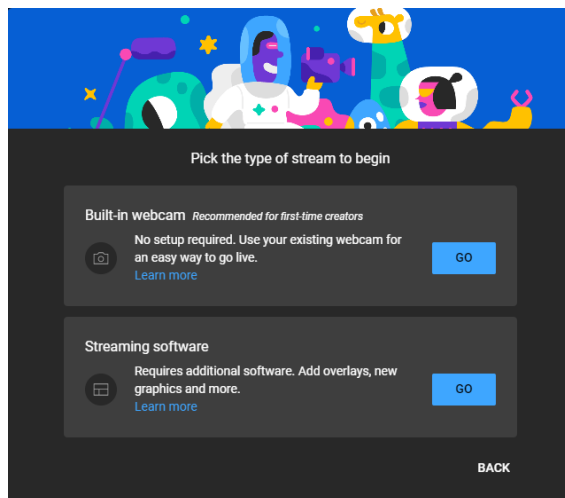

- You will be able to find the server URL and the stream key in **Stream settings** pane of the Youtube Live Control Room. If you'd like, you can also click **Edit** to modify the stream information such as title and descriptions.



Connect streaming software to go live

Viewers will be able to find your stream once you go live

STREAM SETUP HELP

Title
Live Stream Test EDIT

Category
People and blogs

Privacy
Public

Viewers waiting: **0** Likes: **0**

● Start sending us your video from your streaming software to go live

Stream settings
Analytics
Stream health

Stream key

Select stream key

Default stream key (RTMP, variable) ▾

Stream key (paste in encoder)

8pbj-egmr-vjfg-acug-4 RESET COPY

Stream URL

rtmp://a.rtmp.youtube.com/live2 COPY

Backup server URL

rtmp://b.rtmp.youtube.com/live2? COPY

YouTube also supports RTMPS for secure connections. [Learn more](#)

Stream latency (?)

Normal latency

Low-latency

Ultra low-latency

Additional settings

Enable DVR

360° video

Added delay

None ▾

Closed captions

Unlist live replay once stream ends

- Enter “Server URL/Stream key” which is **rtmp://a.rtmp.youtube.com/live2/8pbj-egmr-vjfg-acug-6vsc** in this example in the MRL textbox as depicted in the diagram on the right.

MAIN STREAM

Main Stream

Encoding Format H.264 ▾

Protocols RTMP(S) ▾

Resolution 1920x1080 ▾

Bitrate 4096

Frame Rate 30 ▾

Bitrate Control CBR ▾

I Key Frame Interval 30

Audio And Video Switch AudioOn,VideoOn ▾

MRL rtmp://a.rtmp.youtube.com/li

Default Apply

- Click the **Apply** button to activate the RTMP video stream. Make sure both audio and video are enabled.

✔ Data Update Successful

The RTMP video stream is successfully activated when you see “Data Update Successful” appear at the bottom of the UI.

At the top right corner of the web UI, you should see that the main stream channel is now switched to RTMP(S) mode.

At the top right corner of the web UI, you should see that the main stream channel is now switched to RTMP(S) mode.

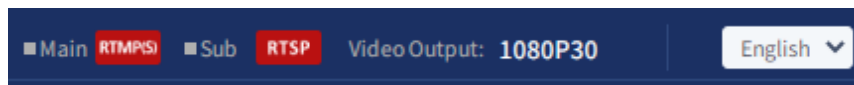

- To end the live stream, simply click “**END STREAM**” which can be found at the top right corner of the Youtube Live Control Room.

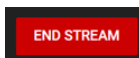

SRT

Read this section to learn how to establish a link between SRT source and destination devices.

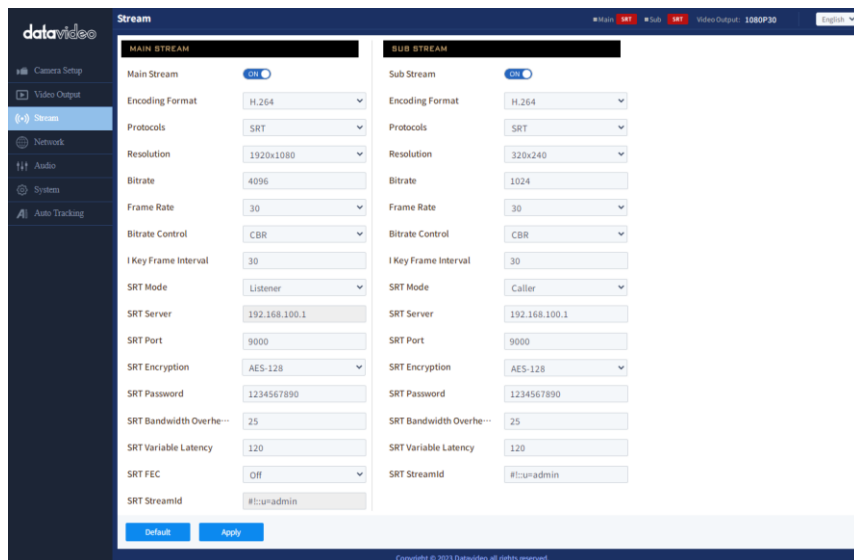

Caller and listener modes work together to establish the SRT link between source and destination devices. It is arbitrary to set one device to listener mode and the other to caller mode. Either can be the source device.

Common SRT parameters are described as follows:

Port number: Range is 1024 to 65535; default is 9000.

SRT Encryption: Options are 128/192/256 bit end-to-end AES encryptions to ensure that content is protected during streaming.

SRT Password: Enter a passphrase of 10 to 79 characters.

Please note that your stream is not encrypted by default. The encryption and the passphrase must be the same at both sender and receiver ends.

Bandwidth Overhead: This is the percentage of the average bandwidth used to accommodate SRT controls. The default is 25%.

Latency: This sets the maximum buffer size for managing SRT packets; the value ranges from 20 to 8,000 ms. The default is 120 ms.

Stream ID: Enter a name for your video stream.

If Caller is selected, enter the IP address of the destination device (decoder) in the **Server** field. If your SRT stream destination is a CDN or media server, the IP address and the port number should be provided by the service provider.

If Listener is selected, **FEC**, also known as forward error correction, will be provided. It is a technique used for packet loss recovery. Select an FEC rate from the drop-down menu.

In the next two sections, we will show you how to establish an SRT link between the PTC-285T and a PC.

Install the vMix Software

Download and install the vMix software: <https://www.vmix.com/>

SRT Stream Setup on PTC-285T and vMix

The PTC-285T/vMIX connection is bidirectional. Regardless of the caller-listener setup, either end can be the camera video source.

PTC-285T set to the Listener Mode

Open the web UI of the PTC-285T then the **Stream** page. Select **SRT** from the **Protocols** pull-down menu then set **SRT mode** to **Listener**. Use the default **SRT port** (9000). If necessary, you can set up **AES encryption** and a 10 digit **passphrase** for an SRT stream.

Lastly, click the **Apply** button to activate the SRT stream.

On the PC or laptop where the vMIX is installed, click Start Menu → vMix(x64) and you should see the interface below after the vMIX is opened.

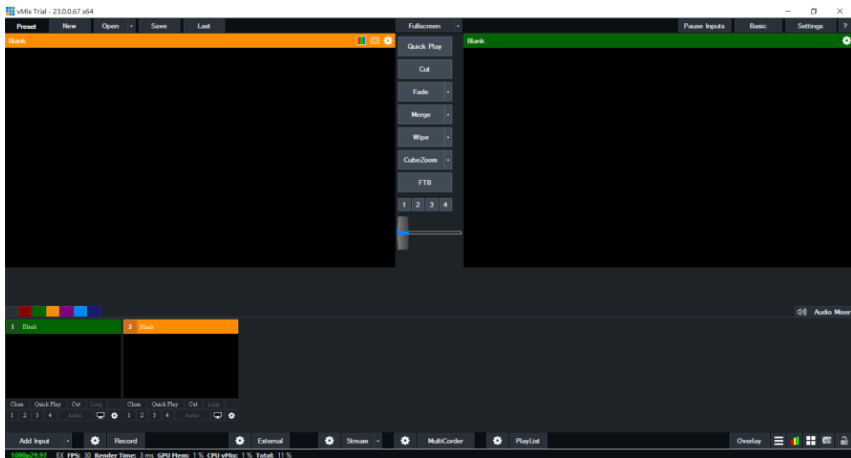

Click “Add Input” then “More”.

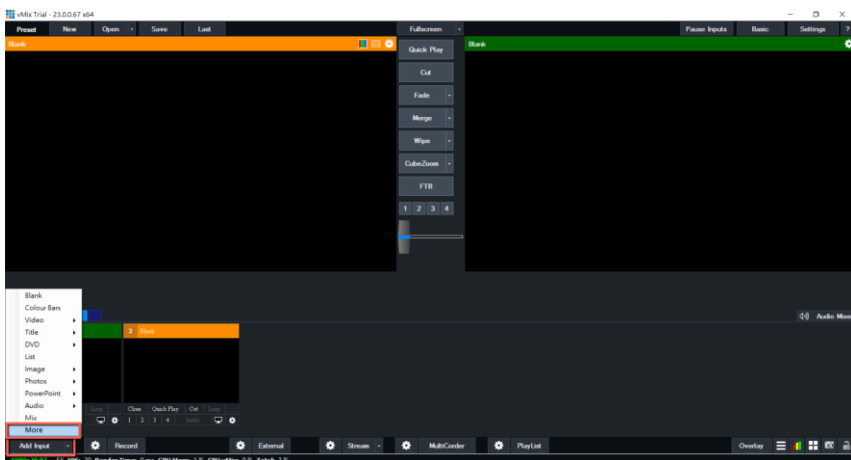

On the Input Select window, click “Stream/SRT” then select “SRT Caller” from the “Stream Type” drop-down menu. After that, enter the following into the respective fields.

- Hostname: 192.168.1.198 (The IP address of your connected device. In this case, it is the PTC-285T)
- Port: 9000

- Passphrase: 1234567890 (The password set previously on the PTC-285T's Web UI)
- Key length: 32

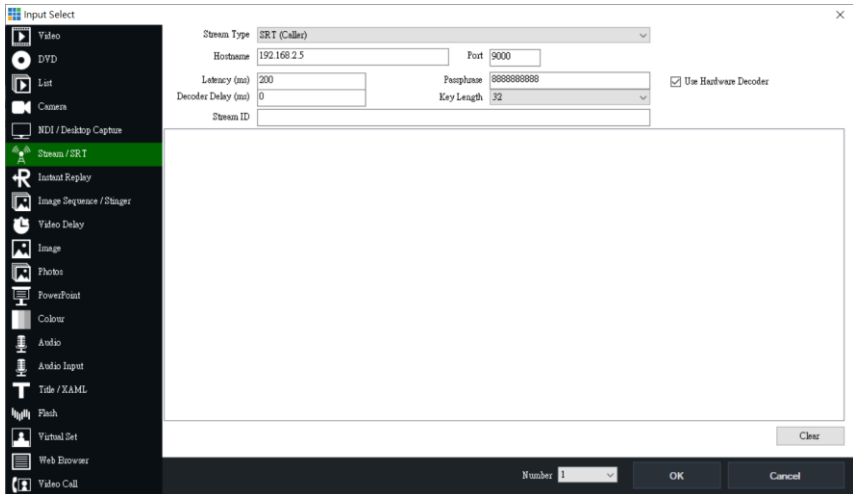

Click the “OK” button.

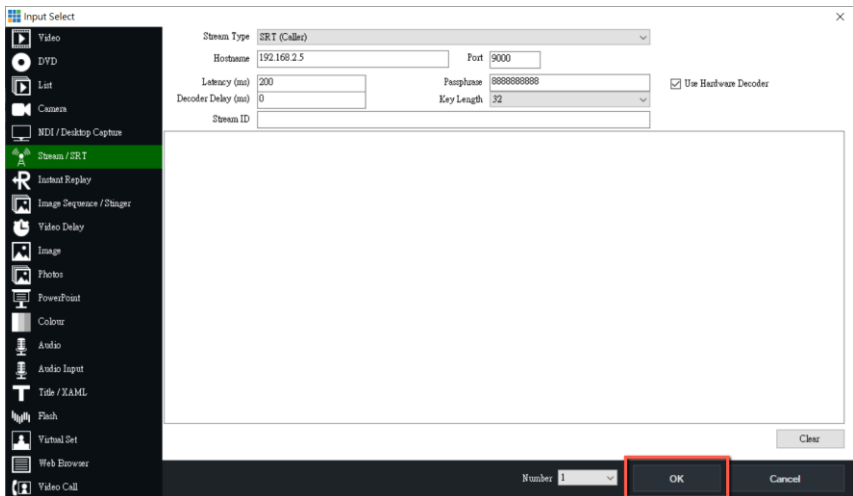

The PTC-285T camera video is now successfully streamed to the vMix via SRT.

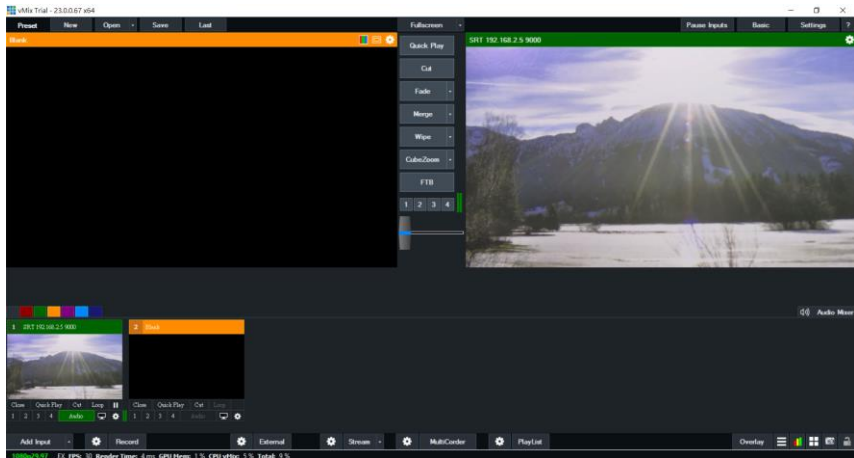

PTC-285T set to the Caller Mode

Open the web UI of the PTC-285T then the **Stream** page. Select **SRT** from the **Protocols** pull-down menu then set **SRT mode** to **Caller**. Enter the IP address of the PC/laptop on which the vMIX is installed. Use the default **SRT port** (9000). If necessary, you can set up **AES encryption** and a 10 digit **passphrase** for an SRT stream.

Lastly, click the **Apply** button to activate the SRT stream.

On the PC or laptop where the vMIX is installed, click Start Menu → vMix(x64) and you should see the interface below after the vMIX is opened.

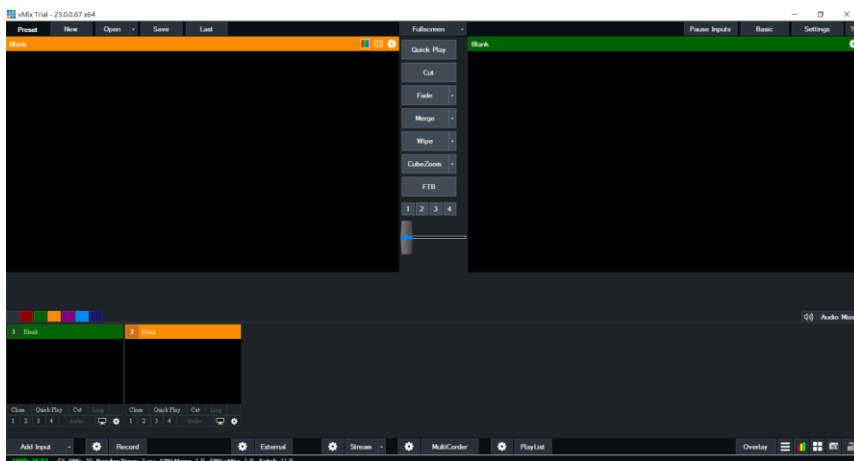

Click “Add Input” then “More”.

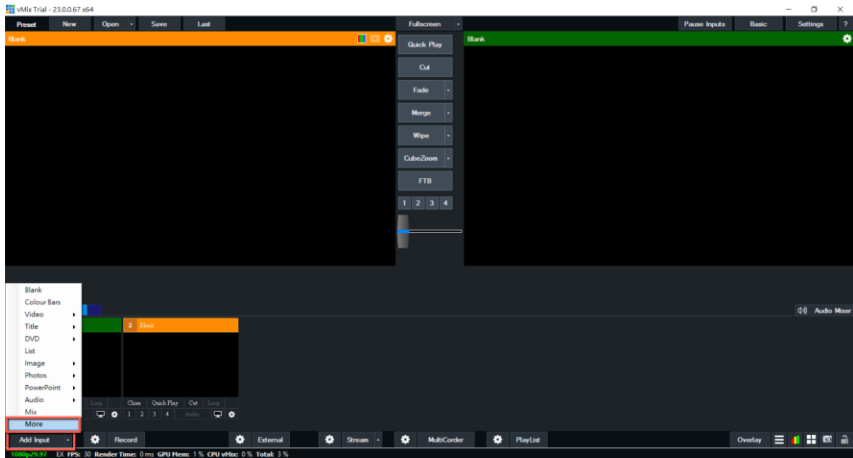

On the Input Select window, click “Stream/SRT” then select “SRT Listener” from the “Stream Type” drop-down menu. After that, enter the following into the respective fields.

- Port: 9000
- Passphrase: 1234567890 (Password for Stream Encryption)
- Key length: 32

Click the “OK” button.

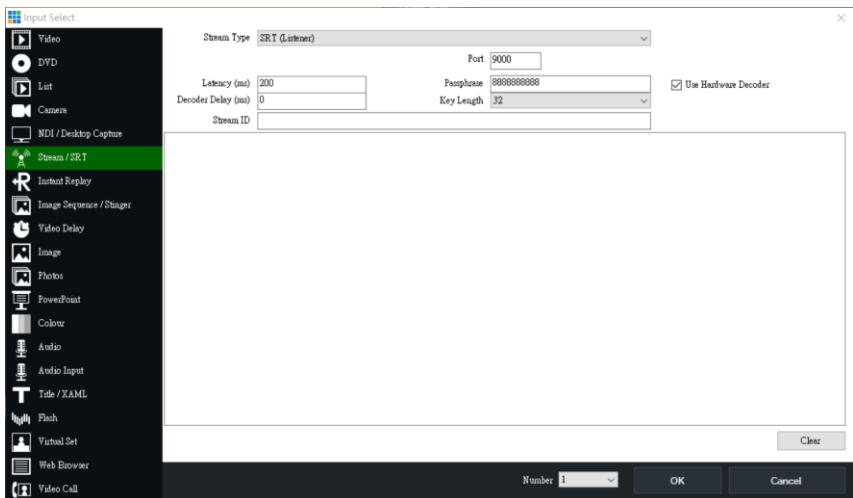

The PTC-285T camera video is now successfully streamed to the vMix via SRT.

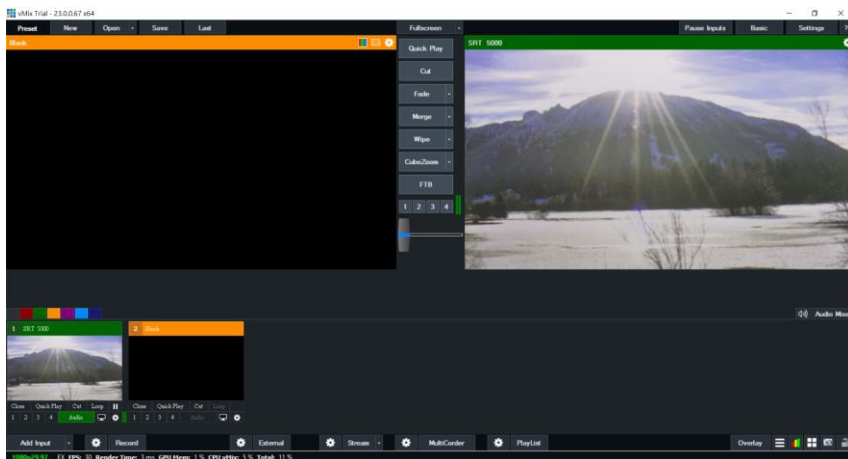

Onvif

Enable ONVIF (Open Network Video Interface Forum) to make your PTC-285T ONVIF compliant in order to allow interoperability with devices from other manufacturers.

Note: All ONVIF-enabled devices need to be connected to the same network.

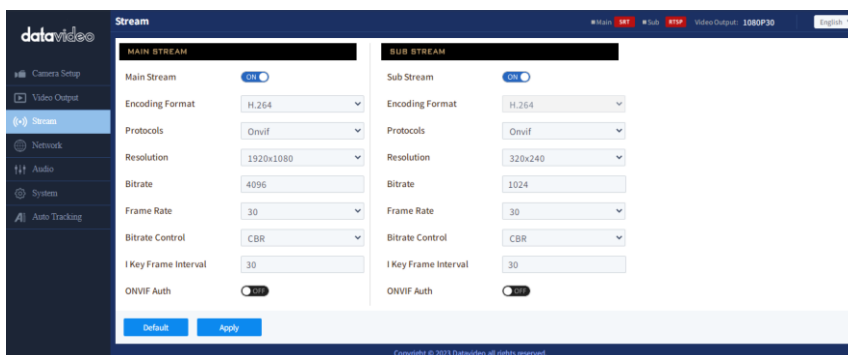

Network

The PTC-285T uses DHCP to obtain an IP address over an Ethernet-based network by default. You can also configure the device to use a static IP address. In this section, we will show you how.

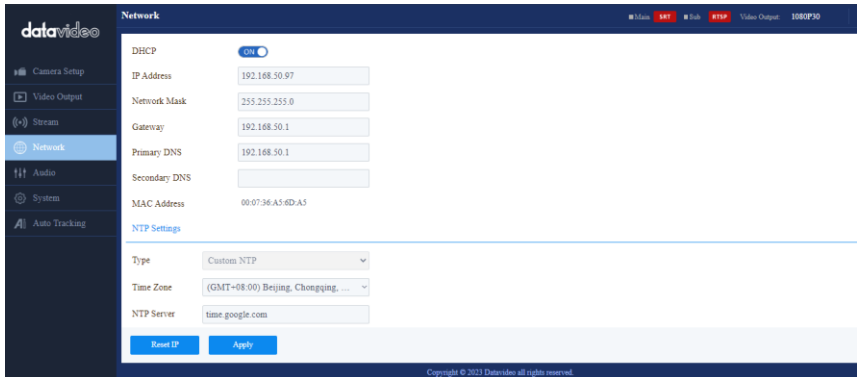

Network Settings

First turn DHCP off then fill in the following fields.

IP address: Enter a static IP address.

Network Mask: Also known as the subnet mask.

Gateway: Enter a gateway IP.

You can also enter IP addresses of the primary and secondary DNS servers. They are however optional. The device's MAC address is shown below.

NTP Settings

NTP settings are configured manually. First select a time zone from the Time Zone drop-down menu then enter the domain name of your NTP server. The default NTP server is time.google.com.

Audio

You can connect an audio source to the PTC-285T. Configure the MIC IN/LINE IN port on the Audio page.

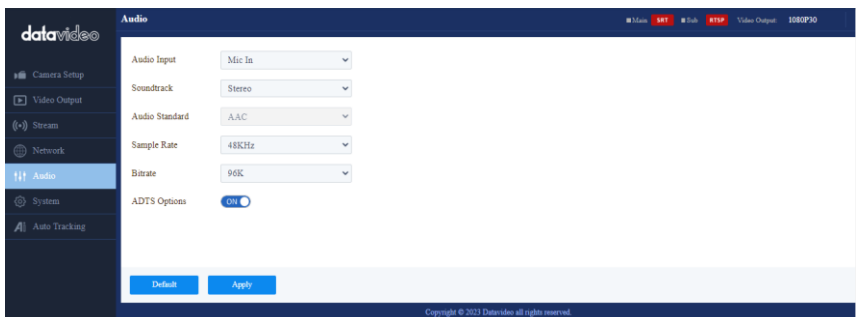

Audio Input

Select between Line IN and MIC IN.

Soundtrack

Set the audio output to Mono or Stereo.

Please note, if Mono is selected, then for a stereo audio source, the left audio channel will be replicated onto the right audio channel. On the contrary, if the audio source is mono, only the left audio channel can be heard.

Audio Standard

Currently disabled.

Sample Rate

You can set the input audio sample rate to either 44.1 or 48 kHz.

Bitrate

Select a bitrate (96K, 128K and 256K) for your audio input.

ADTS Options

Enable for streaming audio over the Internet.

System

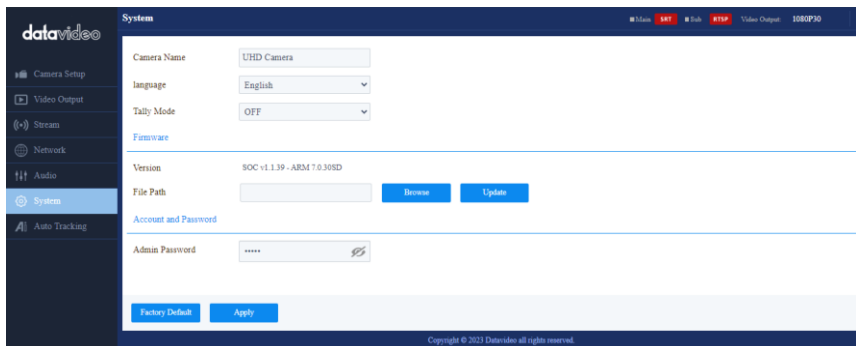

The screenshot shows the 'System' configuration page in the datavideo web interface. The page has a dark blue header with the 'datavideo' logo and navigation icons for Home, RTSP, and Video Output. A sidebar on the left contains menu items: Camera Setup, Video Output, Stream, Network, Audio, System (highlighted), and Auto Tracking. The main content area is titled 'System' and contains the following fields and sections:

- Camera Name:** A text input field containing 'UHD Camera'.
- language:** A dropdown menu set to 'English'.
- Tally Mode:** A dropdown menu set to 'OFF'.
- Firmware:** A section header.
- Version:** A text field showing 'SOC v1.1.39 - ARM 7.0.305D'.
- File Path:** A text input field with 'Browse' and 'Update' buttons.
- Account and Password:** A section header.
- Admin Password:** A password input field with a strength indicator icon.
- Buttons:** 'Factory Default' and 'Apply' buttons at the bottom.

Copyright © 2021 Datavideo all rights reserved.

General

Camera Name

Enter a name for your camera.

Language

Select a preferred language for the web UI.

Tally Mode

Enable the tally light by selecting either green or red. You can also select dual color mode (Red/Green). To disable the tally light, simply select OFF.

Red: The red tally light indicates that the camera is live (enabled for the program channel) and currently being used for the broadcast. It signals to the camera operator and talent that they are actively being recorded or broadcasted.

Green: The green tally light signifies that the camera is on standby (enabled for the preview channel). It indicates to the camera operator and talent that the camera will be the next in use for the broadcast.

Firmware

The current version of firmware installed will be shown here. To update the firmware, click the **Browse** button to search for the latest firmware file saved on the PC's hard disk. Click the **Update** button after the file is uploaded.

Account and Password

View and change the current password here.

Auto-Tracking

Configure the auto-tracking function on this page.

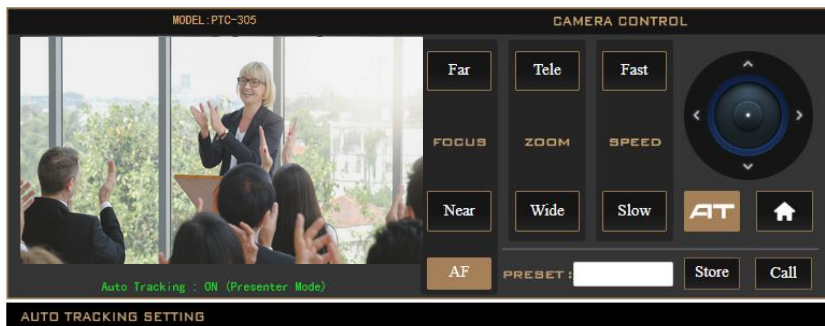

- Track
- Mode
- Auto Zoom
- Auto Tilt
- Detected Indicator
- Tracking Start Position
- OSD Reminder

Figure Size:

Full Half Body Close Up Customized

Size 80

Figure Size Default:

Select Subject:

Placement:

Left Center Right

AT Speed:

Mode

In Presenter mode, the PTC-285T will start tracking as soon as a presenter is on the stage or in the camera view and stops when the presenter leaves the stage.

Auto Zoom

Enable auto zoom so that the camera zooms in/out automatically when the presenter is tracked.

Auto Tilt

Enable auto tilt so that the camera tilts automatically when the presenter is tracked.

Detected Indicator

Once enabled, the camera will detect the presenter and automatically pan, tilt and zoom to follow the targeted person.

Tracking Start Position

This sets the initial tracking position. Use the **Camera Control** panel to move the camera view to where you would like the tracking to begin, then select **Current Location** from the pull-down menu. You can also select **Preset 1** which is a pre-saved location.

OSD Reminder

When OSD reminder is enabled, you will see the following message prompt when auto-tracking is turned ON.

Auto Tracking : ON (Presenter Mode)

Figure Size

You can track **full body**, **half body** or **close-up** of the presenter.

Figure Size:



Full



Half Body



Close Up



Customized

Size



80

Save

Figure Size Default:

Back to default

Select **Customized** if you would like to customize the tracking profile. Use the **Size** slider to adjust between 80 and 350. Use a smaller value if you would like track a closer view and use a larger value otherwise. Click the **Save** button to confirm.

To reset, simply click the **Back to Default** button.

Select Subject

When there are multiple targets, you can use the right and left arrow keys to switch between them. Click the **Confirm** button to confirm selection of the target.

Placement

As shown in the diagram below, you can keep the target to the left, in the center or to the right of the image while the camera tracks it.



Left



Center



Right

AT Speed

You can set the auto-tracking speed to **slow**, **medium (mid)** or **fast**.

8. Remote Control

In addition to using the Ethernet port for remote control, you can also connect external controllers to the PTC-285T via the RS-422 interface or Wi-Fi.

RS-422

You can connect your PC or any keyboard controllers to the RS-422 remote port to control your PTC-285T. Use an Ethernet cable and make your own cable using the pinout information provided in this section.



The RS-422 pinouts are shown below.

RMC-180 Controller (RJ-45 Port)			PTC-285T Camera (RS-422 Port)			
GND	1	White/Orange	GND	White/Orange	1	GND
NC	2	Orange		Orange	2	NC
TX-	3	White/Green		White/Green	3	RX-
RX-	4	Blue		Blue	4	TX-
RX+	5	White/Blue		White/Blue	5	TX+
TX+	6	Green		Green	6	RX+
NC	7	White/Brown		White/Brown	7	NC
NC	8	Brown		Brown	8	NC
<p>1/EXT</p>			<p>1/EXT</p>			

Wi-Fi



PTZ View Assist is an App designed by Datavideo for controlling up to 4 PTC-285T cameras using an Android or iOS device. Connect your Android or iOS device to a wireless router and make sure the DVIP port of the camera is also connected to the same router. Depending on your network environment, you can either connect in DHCP mode or using a static IP address. See [Network Connection](#) of this manual for configuring your network.

For Android devices, please download PTZ View Assist from Google Play.

For iOS devices, please download PTZ View Assist from Apple Store.

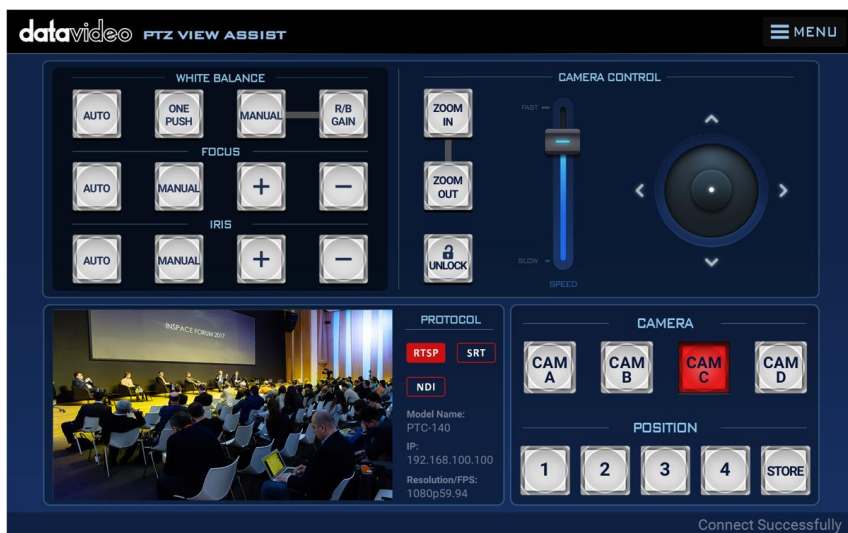

9. Firmware Update

Datavideo usually releases new firmware containing new features or reported bug fixes from time to time. Customers can either download the firmware as they wish or contact their local dealer or reseller for assistance.

This section outlines the firmware upgrade process which should take *approximately few minutes to complete*.

The existing settings should persist through the *firmware upgrade process, which should not be interrupted once started* as this could result in a non-responsive unit.

Ethernet Port

The DVIP port allows you to update the firmware from a remote location. You should connect the PTC-285T via the HBT-16 receiver box to a DHCP server. Connect a PC/Notebook to the same server. In the procedure outlined below, we assume you will be connecting in DHCP mode.

You can establish direct connection if you are using a static IP address.

Requirements

- PTC-285T Unit/HBT-16 Receiver Box
- A PC/Laptop
- Latest firmware downloaded from <https://www.datavideo.com/product/PTC-285T>
- Ethernet Cables and a router if the camera is set to DHCP

Procedure

1. With Ethernet cables, connect the PTC-285T via the HBT-16 receiver box to a router. Also connect a PC/Notebook to the same router.

Note: The PTC-285T's default connection mode is DHCP.

2. Unzip the downloaded file in which you should find the latest firmware file.
3. Open a web browser and enter the camera's IP address in the address bar.
4. On the web user interface that opens, click **System** then locate **Firmware** where the current version of firmware installed will be shown here.

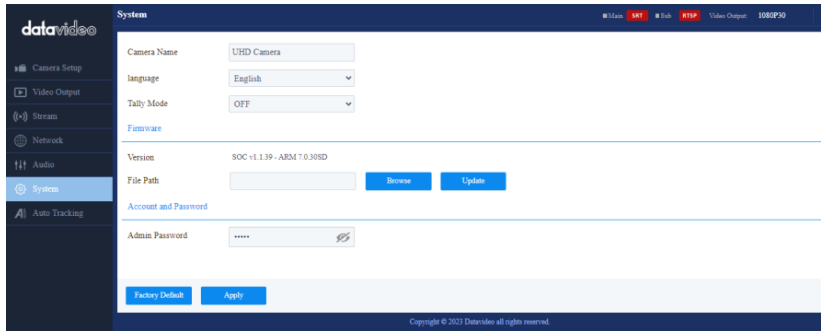

5. To update the firmware, click the **Browse** button to search for the latest firmware file saved on the PC's hard disk.
6. Click the **Update** button after the file is uploaded.

10. Frequently-Asked Questions

This section describes problems that you may encounter while using PTC-285T. If you have any questions, please refer to related sections and follow all suggested solutions. If problem still exists, please contact your distributor or the service center.

No.	Problems	Solutions
1.	What are important points for product maintenance?	<ol style="list-style-type: none"> 1. If the camera will not be used for a long time, please unplug the 12V DC power plug, and remove AC power adapter from AC outlet. 2. Use soft cloth or tissue to clean the camera. 3. After washing the camera lens, dry it with a soft dry cloth. Use a neutral detergent rather than acidic or corrosive detergents to clean the lens.
2.	There is no output video.	<ol style="list-style-type: none"> 1. Check that your power is properly connected. This is indicated by the power LED. 2. Make sure the camera is switched ON with no issues. 3. Check your video cable connection.
3.	I have seen image jitter while zooming in or out.	<ol style="list-style-type: none"> 1. Make sure the camera is properly mounted. 2. Make sure that machines that could cause vibration are not in proximity of the camera.
4.	The camera's web UI cannot be opened using the IE browser.	Microsoft permanently disabled the Internet Explorer browser. Use other browsers such as Google Chrome, Safari and Microsoft Edge.
5.	The remote control is not working.	<ol style="list-style-type: none"> 1. Try setting the camera to CAM1 and try again. 2. Make sure the remote control's battery is fully charged. 3. Check your device working mode. 4. Make sure the OSD menu is closed.
6.	The serial port is not working properly.	<ol style="list-style-type: none"> 1. Make sure your baud rate and device address are correct. 2. Check your device working mode.

		3. Make sure the OSD menu is closed as the serial port is disabled if the OSD menu is active.
7.	I cannot log in to the Web UI.	<ol style="list-style-type: none">1. Check your Ethernet connection.2. Check your network settings such as IP address.

11. Dimensions

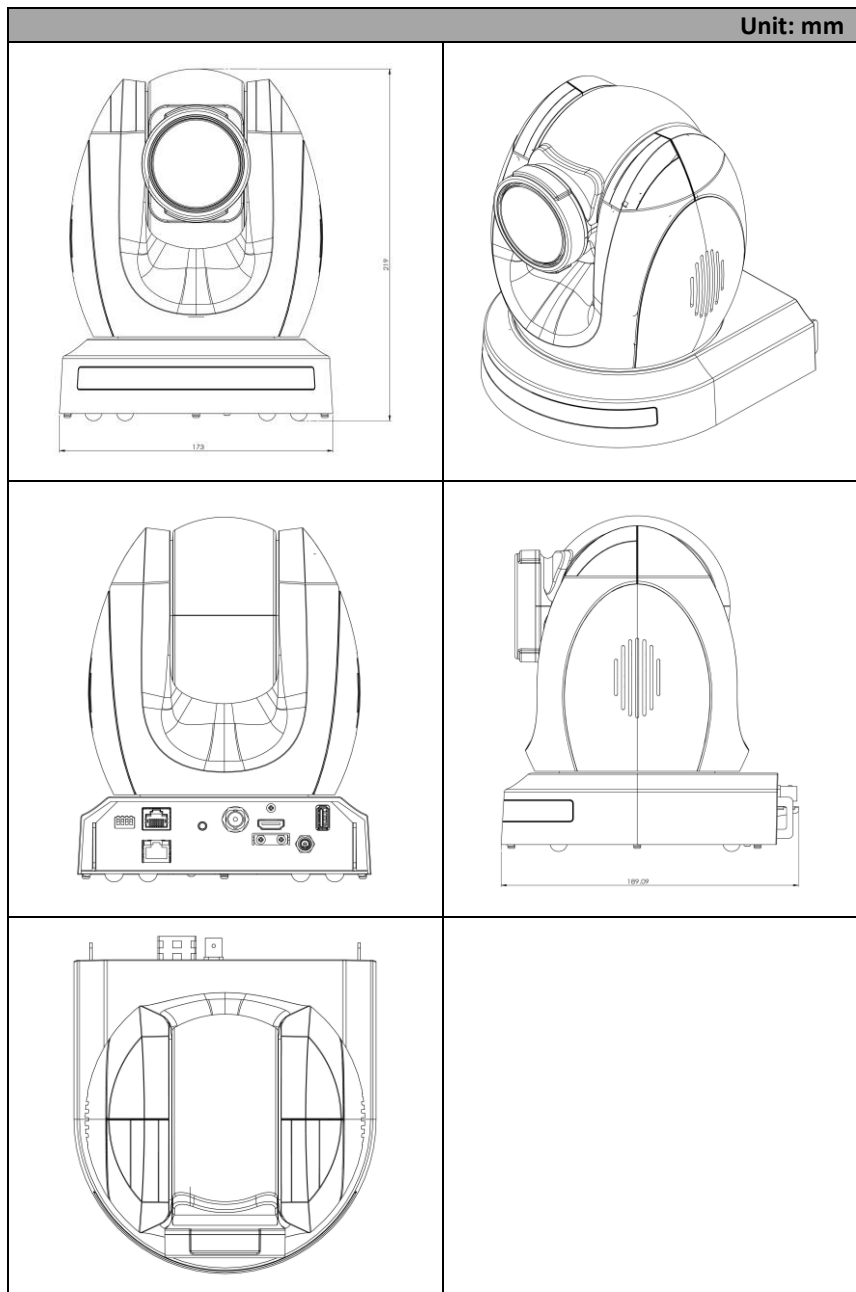

12. Specifications

Camera Parameters	
Product Name	4K HDBaseT Tracking PTZ Camera
Video Format	HDMI/HDBaseT: 2160p60/59.94/50/30/29.97/25 1080p60/59.94/50/30/29.97/25 1080i60/59.94/50 720p60/59.94/50 *2160p60/59.94/50 YUV 4:2:2 SDI: 1080p 60/59.94/50/30/29.97/25 1080i 60/59.94/50 720p 60/59.94/50
Image Sensor	1/2.8" CMOS
Effective Pixels (approx.)	8.51 Mega Pixels
S/N Ratio	≥55dB
Min. Illumination	0.5 Lux @ (F1.8, AGC ON)
Electronic Shutter	1/30s ~ 1/10000s
Zoom Ratio	12x Optical Zoom 16x Digital Zoom
Gamma	N/A
Iris Control	Auto / Manual
Digital Noise Reductions	3D
On-Screen Display (OSD)	English Simplified Chinese Traditional Chinese
White Balance	Auto Indoor Outdoor OnePush Manual VAR
AGC / Gain Control	Yes
Mirror / Flip Image	Yes

Focus Mode	Auto / Manual
Panning / Tilting Range	Pan: 300 degrees Tilt: +130 to -15 degrees
Panning / Tilting Speed	Pan: 0.876°/s ~ 43°/s Tilt: 0.693°/s ~ 21.32°/s
Preset	255 Positions
Focal Length	12x, f = 4.4 (wide) to 52.8 (tele) mm F1.8 to F2.6
Field of View (Horizontal, Wide)	80°
Image Compensation	Backlight compensation
Input /Output Interfaces	
Video Output	HDMI 2.0 x 1 3G-SDI x 1 HDBaseT x 1 10/100/1000M RJ-45 (PoE) x 1
Audio Input	3.5 mm x 1 (Switch between MIC in/Line in on web UI)
Tally LED	Yes
Control Protocol	Pelco-D/Pelco-P VISCA/VISCA over IP DVIP/Onvif
Remote Control Interface	IR Web GUI RS-422/RS-232 DVIP HDBaseT (RJ-45)/Serial control on Receiver Box: Transmit up to 100m
Video Compression Format	H.264/H.265/MJPEG
Audio Compression Format	AAC G711
Audio Bitrate	96Kbps, 128Kbps, 256Kbps
Streaming Protocols	RTSP RTMP(S) Onvif Multicast SRT

First Stream Supported Resolution	3840x2160 1920x1080 1280x720 1024x576 960x540 640x480 640x360
Second Stream Supported Resolution	720x480 640x360 480x270 320x240
Video Bitrate	32Kbps ~ 50Mbps (Single Stream)
Video Bitrate Mode	VBR CBR
Encoding Frame rate	50Hz: 1-50fps 60Hz: 1-60fps
POE	IEEE 802.3at
F/W Update	Via Web UI or USB 2.0
IR Control	Yes
Camera Control Unit	HS-1600T MARK II RMC-180 series RMC-300 series PTZ View Assist APP
Tripod Mount	1/4-20 UNC
Optional Accessories	WM-1 WM-10 WM-11
Color	Dark Blue/White
Dimensions (LxWxH)	185 (W) x 229 (H) x 195.08 (D) mm
Weight	2.7 kg
Operating Temp. Range	0~40 °C
Power	DC 12V 22W

Service & Support

It is our goal to make your products ownership a satisfying experience. Our supporting staff is available to assist you in setting up and operating your system. Please refer to our web site www.datavideo.com for answers to common questions, support requests or contact your local office below.

Please visit our website for latest manual update.

www.datavideo.com/product/PTC-285T

datavideo
www.datavideo.com



@DatavideoUSA @DatavideoIndia2016
@DatavideoEMEA @Datavideojapan
@DatavideoTaiwan @DatavideoLatam
@DatavideoAsia @DatavideoBrasil



@Datavideo
@Datavideo_EMEA
@Datavideo_Taiwan



@DatavideoUSA
@DVTWDVCN



@DatavideoUSA
@DatavideoEurope

All the trademarks are the properties of their respective owners.