



QNAP

QSW-M2106

QSW-M2106R

User Guide

Contents

1. Product Overview

About the QSW-M2106R.....	3
Hardware Specifications.....	3
Package Contents.....	4
Components.....	4
Front Panel.....	4
Front Panel LEDs.....	5
Safety Information.....	5

2. Installation and Access

Installation Requirements.....	7
Setting Up the Switch.....	7
Attaching Rubber Feet.....	7
Installing Handles.....	9
Connecting the Switch to a Computer or Network.....	10
Connecting the Switch to a Computer.....	10
Connecting the Switch to a Network.....	11
Switch Access.....	12
Accessing the Switch Using a Browser.....	12
Accessing the Switch Using Qfinder Pro.....	13

3. Basic Operations

LEDs.....	14
Reset Button.....	15

4. QSS

About QSS.....	16
Getting Started.....	16
Network Management.....	16
Configuring Port Settings.....	16
Adding a VLAN.....	17
Adding a Link Aggregation Group (LAG).....	17
Managing Rapid Spanning Tree Protocol (RSTP) Settings.....	18
Configuring the LLDP Settings.....	19
Adding a Static MAC Address.....	19
Configuring IGMP Snooping.....	20
Configuring QoS Settings.....	20
Managing Access Control List (ACL) Entries.....	22
Deleting a Network Setting.....	23
Monitoring Network Settings.....	23
System Management.....	24
System Settings.....	24
Firmware Update.....	29

5. Support and Other Resources

6. Glossary

myQNAPcloud.....	34
Qfinder Pro.....	34
QSS.....	34

QuNetSwitch.....34

7. Notices

Limited Warranty..... 35
Disclaimer..... 35
GNU Public License..... 35
CE Notice..... 43
FCC Notice..... 43
VCCI Notice..... 44
BSMI Notice..... 44
SJ/T 11364-2006..... 44
EU Directive 2002/96/EC Waste Electronic and Electrical Equipment (WEEE)..... 45
EU RoHS Statement..... 45
Laser Compliance Notice..... 45
UKCA Notice..... 45

1. Product Overview

This chapter provides basic information about the QNAP device.

About the QSW-M2106R

The QSW-M2106R is a multi-gigabit Ethernet switch that provides Layer 2 network management. The switch is equipped with six 2.5 GbE RJ45 ports, two 10 GbE RJ45 ports, and two 10 GbE SFP+ combo ports for enhanced network scalability and operational productivity. The switch can be accessed using the RJ45 console port for efficient device management and switch operations.

Hardware Specifications



Warning

If your QNAP product has hardware defects, return the product to QNAP or a QNAP-authorized service center for maintenance or replacement. Any attempt to repair or perform maintenance procedures on the product by you or an unauthorized third party invalidates the warranty.

QNAP is not responsible for any damage or data loss caused by unauthorized modifications and installation of unsupported third-party applications.

For details, see the [QNAP Warranty Terms and Conditions](#).



Tip

Model specifications are subject to change without prior notice. To see the latest specifications, go to <https://www.qnap.com>.

Ordering P/N	CPU	Memory
QSW-M2106R-2S2T	Marvell® Prestera® 98DX2528	1 GB

Component	QSW-M2106R-2S2T
Processor	
CPU	Marvell ® Prestera® 98DX2528
Frequency	Dual-core
Architecture	ARM 32-bit
Chipset	Marvell ® Prestera® 98DX2528
Network interfaces	<ul style="list-style-type: none"> • 6 x 100M/1G/2.5G RJ45 ports • 2 x 100M/1G/2.5G/5G/10G GbE RJ45 ports • 2 x 1G/10G SFP+ combo ports
Management interfaces	1 x RJ45 console port
Total power consumption	40W
Interface	
Buttons	Switch reset
LEDs	
System	Status
Ports	<ul style="list-style-type: none"> • Speed • Activity
Dimensions	

Component	QSW-M2106R-2S2T
Form factor	Compact
Dimensions (H x W x D)	43.3 x 207 x 248.8 mm (1.70 x 8.14 x 9.79 in)
Net weight	1.55kg (3.41 lbs)
Others	
Power supply unit	100-240V, 50/60 Hz
Operating temperature	0°C to 40°C (32°F to 104°F)
Relative humidity	<ul style="list-style-type: none"> Non-condensing relative humidity: 5% to 95% Wet-bulb temperature: 27°C (80.6°F)

Package Contents

Item	Quantity
QSW-M2106R	1
Power cord	1
Rail brackets	2
Screws for rail brackets	6
Rubber feet	4
Quick Installation Guide (QIG)	1

Components

Front Panel

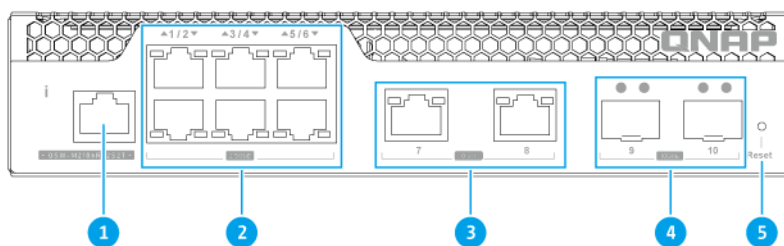

No.	Component	No.	Component
1	RJ45 console port	4	10 GbE SFP+ ports
2	2.5 GbE RJ45 ports	5	Switch reset button

No.	Component	No.	Component
3	10 GbE RJ45 ports	-	-

Front Panel LEDs

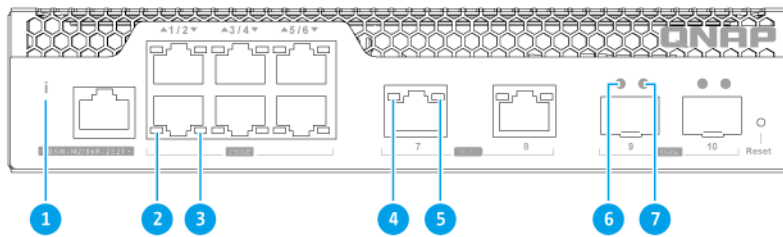

No.	Component	No.	Component
1	Switch status LED	5	10GbE RJ45 (5G/2.5G/1G/100M speed) LED
2	2.5 GbE RJ45 (2.5G speed) LED	6	10GbE SFP+ (10G speed) LED
3	2.5 GbE RJ45 (1G/100M speed) LED	7	10GbE SFP+ (1G speed) LED
4	10GbE RJ45 (10G speed) LED	-	-

Safety Information

The following instructions help ensure personal safety and environmental safety. Read these instructions carefully before performing any operation.

General Instructions

- The device should be stored in a secure location with restricted access, controlled through the use of a tool, lock and key, or any means of security.
- Only qualified, skilled, and authorized persons with knowledge of all restrictions, safety precautions, and installation and maintenance procedures should have physical access to the device.
- To avoid potential injury or damage to components, ensure that the drives and other internal system components have cooled before touching them.
- Observe electrostatic discharge (ESD) procedures to avoid potential injury or damage to components.

Power

- To reduce the risk of fire or electric shock, ensure that you only connect the power cord to a properly grounded electrical outlet.

- To avoid serious injuries, a trained service technician must disconnect all PSU cords from the device before installing or replacing system components.

System Battery

- This product contains a button battery.
- If swallowed, a lithium button battery can cause severe or fatal injuries within 2 hours.
- Keep batteries out of reach of children.
- If you think batteries may have been swallowed or placed inside any part of the body, seek immediate medical attention.
- To avoid potential battery explosion, causing injury or damage to components, ensure that you replace the existing battery with a battery of the same type.
- Dispose of used batteries properly according to local regulations or the instructions of the battery manufacturer.

Moving Parts

-



Moving fan blades: Keep your body parts away from moving fan blades while the device is connected to a power source.

-



Moving components: Keep your body parts away from other moving components.

- The device is not suitable for use in locations where children are likely to be present.

2. Installation and Access

This chapter provides specific hardware installation and switch access steps.

Installation Requirements

Category	Item
Environment	<ul style="list-style-type: none"> • Room temperature: 0°C to 40°C (32°F to 104°F) • Non-condensing relative humidity: 5% to 95% • Wet-bulb temperature: 27°C (80.6°F) • Flat, anti-static surface without exposure to direct sunlight, liquids, or chemicals • Free from objects that may obstruct the switch ventilation or apply pressure to the switch or power cord.
Hardware and peripherals	<ul style="list-style-type: none"> • Computer or NAS • Network cable
Tools	<ul style="list-style-type: none"> • Phillips #1 or #2 screwdriver • Flat head screwdriver • Anti-static wrist strap

Setting Up the Switch

1. Place your switch in an environment that meets the requirements.
For details, see [Installation Requirements](#).
2. Power on the switch.
3. Connect the switch to a computer or network.
For details, see [Connecting the Switch to a Computer](#).
4. Log in to QSS.

Attaching Rubber Feet

1. Power off the device.
2. Disconnect the power cord from the electrical outlet.
3. Disconnect all cables and external attachments.
4. Turn the device upside down.

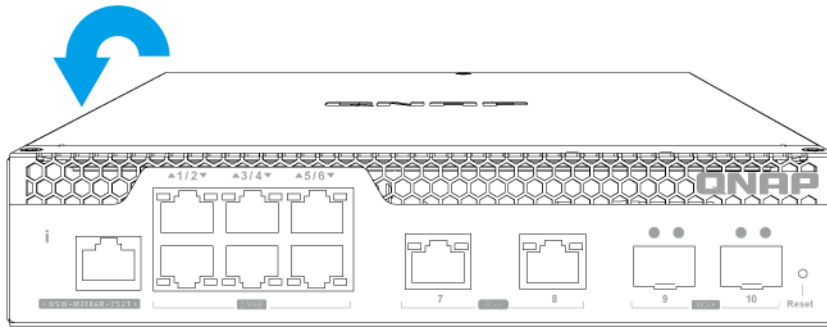

5. Attach the rubber feet.

- a.** Remove the protective film from the rubber feet.
- b.** Attach the rubber feet.

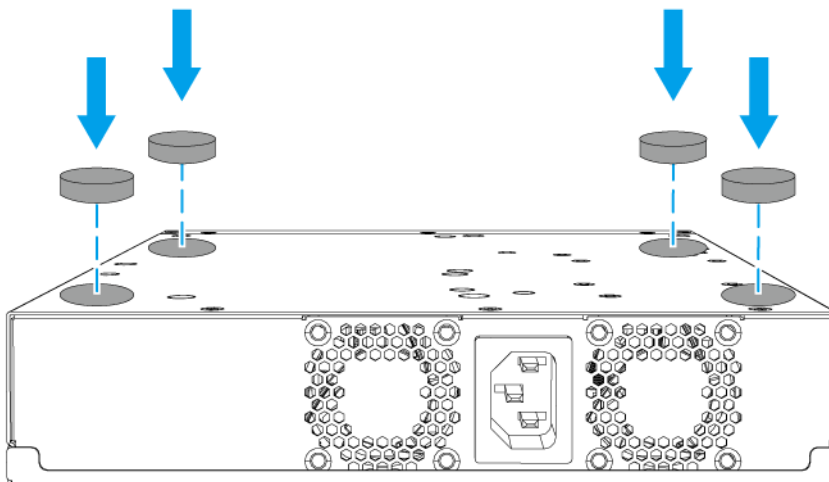

- c.** Place the device in its normal upright position.

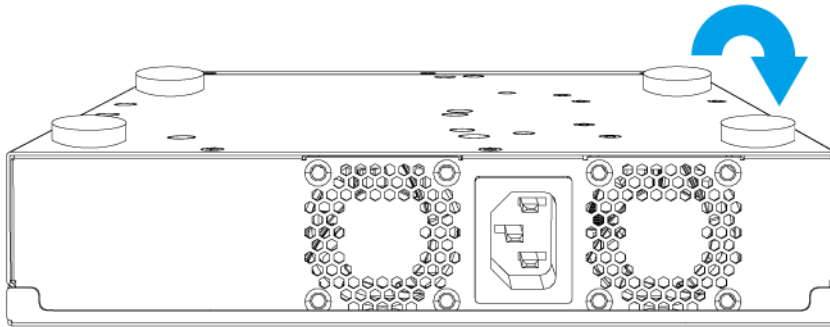

6. Connect all cables and external attachments.
7. Connect the power cord to the electrical outlet.
8. Power on the device.

Installing Handles

Installing handles enables you to better grip and secure the device on a rack.

1. Power off the device.
2. Disconnect the power cord from the electrical outlet.
3. Disconnect all cables and external attachments.
4. Install a handle on an angle bracket.
 - a. Align the openings on the handle with the two round screw holes on the angle bracket.
 - b. Attach the screws to lock the handle to the angle bracket.

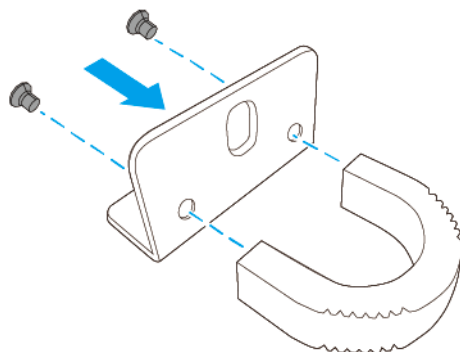

5. Install the angle bracket on the device.
 - a. Align the holes on the angle bracket with the holes on the chassis.

**Note**

Ensure that the handle faces the same direction as the front panel.

- b. Attach the screws to lock the angle bracket to the chassis..

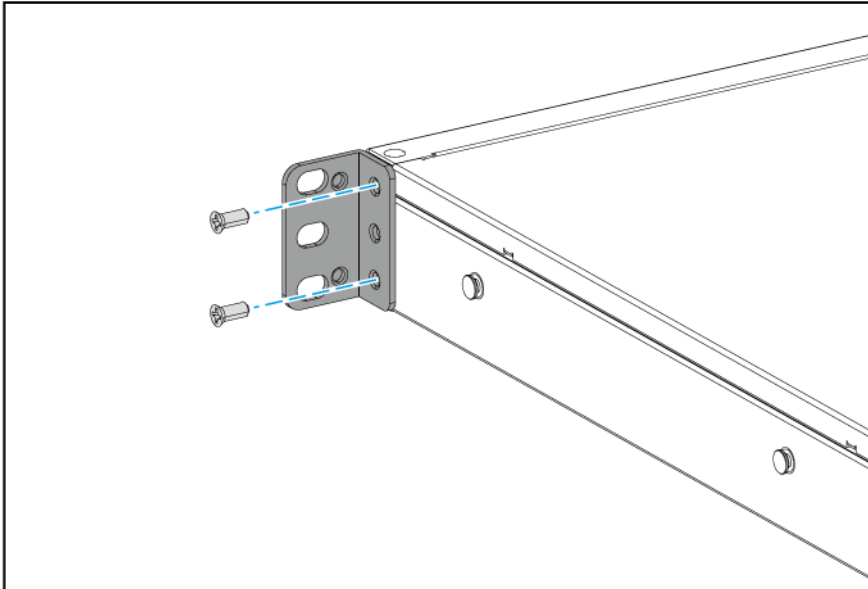

6. Install a second handle on the other side of the chassis.
7. Connect all cables and external attachments.
8. Connect the power cord to the electrical outlet.
9. Power on the device.

Connecting the Switch to a Computer or Network

You can connect the switch to a computer or local area network. For details, see the following topics:

- [Connecting the Switch to a Computer](#)
- [Connecting the Switch to a Network](#)

Connecting the Switch to a Computer

Connecting the switch to a QNAP NAS allows you to expand storage capacity and back up data to another NAS through network cable connections to a PoE or host port on the switch. However, you must connect the switch to a computer to configure the settings.

1. Power on the switch.
2. Connect the switch to a computer.
 - a. Connect a network cable to the host port on the switch.

- b. Connect the network cable to a Gigabit network port on the computer.
- c. Optional: Connect the switch to the NAS.

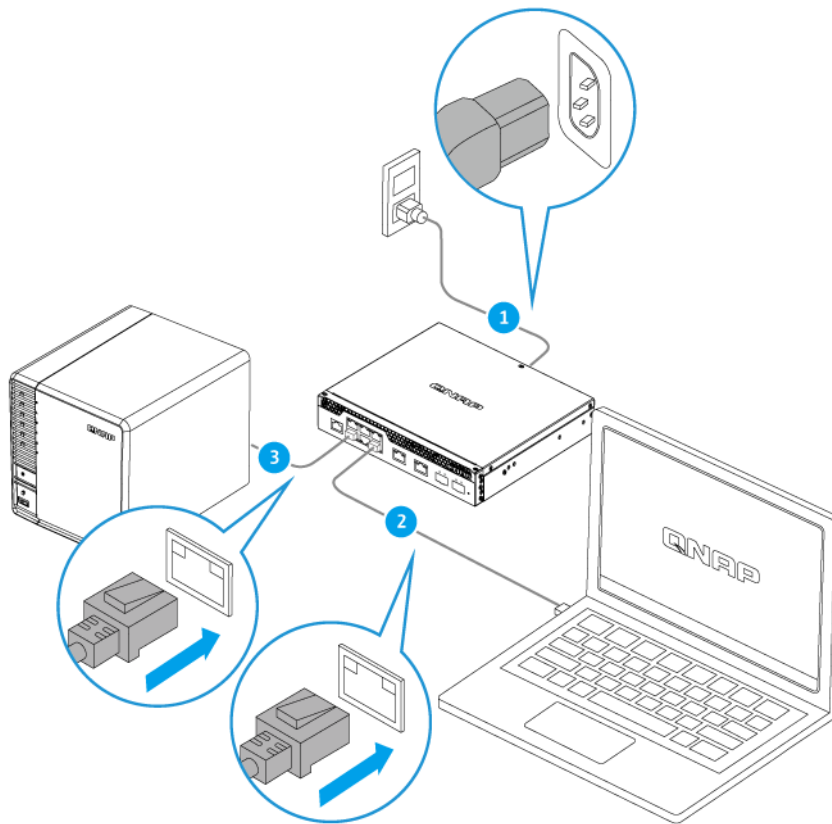

3. Verify that the computer recognizes the switch.
 - a. Open Qfinder Pro on the host computer.

**Note**

To download Qfinder Pro, go to <https://www.qnap.com/utilities>.

- b. Locate the switch on the list.

Connecting the Switch to a Network

You can connect the switch to the local area network through the host port or a PoE port.

1. Power on the switch.
2. Connect the switch to your local area network using the host port.
3. Run Qfinder Pro on a computer that is connected to the same local area network.

**Note**

To download Qfinder Pro, go to <https://www.qnap.com/utilities>.

4. Locate the switch in the list and then double-click the name or IP address. The QSS login screen appears.

5. Enter your QSS login information.
6. Click **Log In**.

Switch Access

Method	Description	Requirements
Web browser	<p>You can access the switch using any computer on the same network if you have the following information:</p> <ul style="list-style-type: none"> • Switch name (Example: http://example123/) or IP address • Login credentials of a valid user account <p>For details, see Accessing the Switch Using a Browser</p>	<ul style="list-style-type: none"> • Computer that is connected to the same network as the switch • Web browser
Qfinder Pro	<p>Qfinder Pro is a desktop utility that enables you to locate and access QNAP devices on a specific network. The utility supports Windows, macOS, Linux, and Chrome OS. For details, see Accessing the Switch Using Qfinder Pro.</p>	<ul style="list-style-type: none"> • Computer that is connected to the same network as the switch • Web browser • Qfinder Pro

Accessing the Switch Using a Browser



You can access the switch using any computer on the network if you know its IP address and the login credentials of a valid user account. QNAP switches support DHCP client configuration by default for IP assignment. When connected to a network, the switch automatically obtains an IP address from a DHCP server.



Note

- If you do not know the IP address of the switch, can locate it using Qfinder Pro.
- If the switch is not connected to a DHCP supported network, you can access the switch web interface by changing the IP address of the computer to 169.254.100.102.
- The default IP address of the switch is 169.254.100.101.

1. Verify that your computer is connected to the same network as the switch.
2. Open a web browser on your computer.
3. Type the IP address of the switch in the address bar.
The QSS login page appears.
4. Specify the default username and password.

Default Username	Default Password
admin	<p>The MAC address of the switch image omitting any punctuation and capitalizing any letters.</p> <p> Tip For example, if the MAC address is 00:0a:0b:0c:00:01, the default password is 000A0B0C0001. You can find the MAC address using Qfinder Pro. It is also printed on a sticker on the device as "MAC".</p> <p> Note You are prompted to change the password after logging in for the first time. QNAP strongly recommends changing the password after first time login for security reasons.</p>

5. Click **Login**.

The QSS desktop appears.



Important

After setting up the switch, ensure that you change the IP address of the computer to the original configuration.

Accessing the Switch Using Qfinder Pro

1. Install Qfinder Pro on a computer that is connected to the same network as the switch.



Tip

To download Qfinder Pro, go to <https://www.qnap.com/en/utilities>.

2. Open Qfinder Pro.
Qfinder Pro automatically searches for all QNAP devices on the network.
3. Locate the switch in the list, and then double-click the name or IP address.
The QSS login screen opens in the default web browser.
4. Specify the default username and password.

Default Username	Default Password
admin	<p>The MAC address of the switch image omitting any punctuation and capitalizing any letters.</p> <p> Tip For example, if the MAC address is 00:0a:0b:0c:00:01, the default password is 000A0B0C0001. You can find the MAC address using Qfinder Pro. It is also printed on a sticker on the device as "MAC".</p>

5. Click **Login**.

The QSS desktop appears.

3. Basic Operations

This chapter describes basic switch operations.

LEDs

LEDs indicate system status and related information when the switch is powered on. The following LED information applies only when the switch is connected to the network.

For details on the location of the LEDs, see [Front Panel LEDs](#).

LED	Status	Description
System Status	Green	The device is ready.
	Flashes green	<ul style="list-style-type: none"> The device is being initialized. The firmware is being updated. <div style="border-left: 2px solid #0070C0; padding-left: 10px; margin-top: 10px;">  Note When updating the firmware, do not remove the power cord or USB cable, and do not force-exit the application. </div> <ul style="list-style-type: none"> The device is being reset.
	Red	A fatal device error occurred.
	Off	The device is powered off.
2.5 GbE RJ45 (2.5G speed)	Green	The link speed is operating at 2.5 Gbps.
	Flashes green	Data is being transmitted.
	Off	There is no network connection.
2.5 GbE RJ45 (1G/100M/10M speed)	Orange	The link speed is operating at 1 Gbps or 100 Mbps.
	Flashes orange	Data is being transmitted.
	Off	There is no network connection.
10 GbE RJ45 (10G speed)	Green	The link speed is operating at 10 Gbps.
	Flashes green	Data is being transmitted.
	Off	There is no network connection.
10 GbE RJ45 (5G/2.5G/1G/ 100M speed)	Orange	The link speed is operating at 5 Gbps, 2.5 Gbps, 1 Gbps, or 100 Mbps.
	Flashes orange	Data is being transmitted.
	Off	There is no network connection.
10GbE SFP+ (10G speed)	Green	The link speed is operating at 10 Gbps.
	Flashes green	Data is being transmitted.
	Off	There is no network connection.
10GbE SFP+ (1G speed)	Orange	The link speed is operating at 1 Gbps.
	Flashes orange	Data is being transmitted.
	Off	There is no network connection.

Reset Button

Operation	User Action	Result
Basic system reset	Press and hold the button for 5 seconds.	<p>The following settings are reset to default:</p> <ul style="list-style-type: none"> System administrator password: The default password is the first MAC address in uppercase letters without special characters. For example, if the first MAC address is 00-08-9B-F6-15-75, then the admin password would be 00089BF61575. <p> Note You can find the first MAC address with Qfinder Pro or attached to a label on the device listed as MAC1.</p> <ul style="list-style-type: none"> The admin account is automatically enabled.
Advanced system reset	Press and hold the button for 10 seconds.	The default factory settings are restored.

4. QSS

About QSS

The QNAP Switch System (QSS) is a network management operating system for QNAP switch devices. QSS allows for Layer 2 network administration and system management of the switch.

Getting Started

1. Log in to the switch as an administrator.
The default administrator account is `admin`.
For details, see [Switch Access](#).
2. Configure the system settings.
For details, see [System Settings](#).
3. Configure port settings and other network settings.
For details, see [Network Management](#).

Network Management

Basic network configuration of the switch includes port management, VLAN configuration, configuration of various protocols, and traffic management via Quality of Service (QoS) and Access Control Lists (ACLs).

Dashboard

The dashboard opens to the configuration section of the interface. Click the drop-down menu in the dashboard to view the port status, VLAN status, link aggregation status, and port traffic for all ports.

You can also delete user-configured network settings and monitor the network settings of the switch.

Configuring Port Settings

1. Log in to QSS.
2. Go to **Configuration > Port Management**.
3. Go to **Port Configuration**.
4. Identify a port.
5. Configure the settings.

Setting	Description
State	Controls the operation status for a port
Speed	Specifies the maximum speed at which a port can operate
Flow Control	Controls the flow control status for a port  Important Flow Control is not supported when the port speed is set to HDX.

6. Click **Save**.

QSS saves the settings.

Adding a VLAN

A virtual LAN (VLAN) groups multiple network devices together and limits their broadcast domain. Members of a VLAN are isolated and network traffic is only sent between group members.

Each VLAN is assigned a specific VLAN identification number. The **VLAN** screen displays information about existing VLANs and provides access to VLAN configuration options.

1. Log in to QSS.
2. Go to **Configuration > VLAN** .
3. Click **Add**.
The **Add VLAN** window opens.
4. Specify a VLAN ID.
5. Select ports to include in the VLAN.
Only tagged ports can belong to multiple VLANs.
6. Click **Save**.

QSS adds the VLAN.

Adding a Link Aggregation Group (LAG)

Link Aggregation Control Protocol (LACP) allows you to combine multiple network adapters into a single logical network interface. This ensures increased throughput and provides redundancy. In case of port failure, traffic continues on the remaining ports.



The **Link Aggregation** page displays information about existing link aggregation groups and provides access to configuration options.



Warning

To prevent network loop errors during the LAG configuration process, do not connect the switch to other devices using more than one network cable until after you have configured LAGs on all the devices. You can enable loop protection to avoid network loops in the connected network.

1. Log in to QSS.
2. Go to **Configuration > Link Aggregation** .
3. Identify a group.
4. Click .
The **Edit Group** window opens.
5. Configure the group settings.

Setting	Description
Mode	<p>Controls the link aggregation mode for the group</p> <ul style="list-style-type: none"> • LACP: Provides automatic failover and dynamic configuration • Static: Aggregates all configurations at once on the selected link aggregation ports <p> Important Enable Link Aggregation before connecting cables to the switch to avoid creating a data loop.</p>
Port Configuration	<p>Specifies which ports are included in the group</p> <p> Note Ensure that you configure the same settings for all the member ports in a LAG.</p>

6. Click **Save**.

QSS updates the group settings.



Note

When assigning a LAG to a VLAN, QNAP recommends removing individual LAG port members from the VLAN, and then adding the entire group to the VLAN as required. If individual port members are not removed, the VLAN is reset to its default settings.

Managing Rapid Spanning Tree Protocol (RSTP) Settings

RSTP provides rapid convergence of the spanning tree and builds a loop-free topology for the switch network. RSTP allows you to enable backup links in case an active link fails.





Note

- RSTP is disabled by default.
- The default bridge priority for the switch is 32768.

Configuring the RSTP Settings

1. Log in to QSS.
2. Go to **Configuration > RSTP**.
3. Change the RSTP control status.

Toggle Setting	Description
	Click to enable the RSTP function.
	Click to disable the RSTP function.

4. Click **Save**.

QSS saves the setting.

Setting Bridge Priority

You can configure the RSTP bridge priority of the switch in the RSTP configuration field.

1. Log in to QSS.
2. Go to **Configuration > RSTP > RSTP Configuration** .
3. Enable RSTP.



Note

For details, see [Configuring the RSTP Settings](#).

4. Select the RSTP bridge priority from the drop-down list.



Note

The default priority is 32768 and it is recommended that you set the bridge priority to zero for root bridge priority.

5. Click **Save**.

QSS updates the RSTP bridge priority.

Configuring the LLDP Settings

The Link Layer Discovery Protocol (LLDP) uses periodic broadcasts to advertise device information over the network and discover neighboring devices. This protocol operates by establishing a distributed database and gathering information from neighboring ports connected by a network link.

The **LLDP** page displays information about detected devices and allows you to enable or disable LLDP.

1. Log in to QSS.
2. Go to **Configuration > LLDP** .
3. Change the LLDP control status.

Toggle Setting	User Action
	Click to enable the LLDP function.
	Click to disable the LLDP function.

4. Click **Save**.

QSS saves the setting.

Adding a Static MAC Address

The MAC address table tracks MAC addresses and forwards associated unicast traffic through specific ports.

1. Log in to QSS.
2. Go to **Configuration > LLDP > MAC Address Table** .
3. Specify the aging time for the MAC table.

**Note**

You can configure the amount of time that an entry remains in the MAC table.

4. Click **Add**.
The **Add Static MAC Address** window opens.
5. Configure the MAC address settings.
 - a. Specify a VLAN ID.
 - b. Specify a MAC address.
 - c. Select at least one port.
6. Click **Save**.
The **Add Static MAC Address** window closes.

QSS adds the MAC address.

Configuring IGMP Snooping

The Internet Group Management Protocol (IGMP) manages membership to IP multicast groups. IP hosts and adjacent multicast routers use IGMP to establish multicast group memberships.

The **IGMP Snooping** page displays information about detected IGMP groups and provides access to IGMP snooping configuration options.

1. Log in to QSS.
2. Go to **Configuration > IGMP Snooping**.
3. Click .
QSS enables IGMP snooping.
4. Configure the IGMP snooping settings.

Setting	Description
Multicast flood blocking	Blocks multicast flooding from unknown sources
Router Port	Specifies which ports to use as the router port for the VLAN After receiving an IGMP packet, QSS forwards the traffic through the selected router ports.
Fast Leave	Specifies the ports that support the IGMP v2 Fast Leave feature After receiving an IGMP leave message, QSS stops forwarding multicast traffic to the selected Fast Leave ports.

5. Click **Save**.

QSS saves the IGMP snooping settings.

Configuring QoS Settings

Quality of service (QoS) improves network traffic shaping by classifying and prioritizing different network devices and packets. QoS allows you to configure traffic policies and enabling these policies on the switch ports.

To change the QoS priority of a port, go to **Configuration > QoS**, assign a priority value between 0 and 7, and then click **Save**.



Note

- QSS supports eight priority queue settings from 0 to 7, where 0 is the lowest priority and 7 is the highest priority. The port assigned the highest priority is always allowed to send data first.
- You can disable the CoS and DSCP inspection settings at the same time, but these settings cannot be enabled simultaneously.
- By default, Weighted Round Robin (WRR) is applied as the default QoS scheduling mechanism. The weight of the queue is directly proportional to the number of packets sent from the queue. WRR prevents packets in low-priority queues from not being serviced, and ensures that the switch preferentially transmits delay-sensitive packets.

Configuring CoS Priority for QoS

CoS (Class of Service) is a 3-bit field in a frame Ethernet header. The CoS value determines which queue the traffic is forwarded to, based on CoS value (0-7).

1. Log in to QSS.
2. Go to **Configuration > QoS**.
3. Identify a port.
4. Click  under CoS Inspection.
QSS enables CoS inspection on the port.
5. Click **Edit CoS Inspection**.
6. Assign a priority value between 1 and 8 to the CoS value.
7. Click **Save**.
QSS updates the priority queue of the CoS value.
8. Click **Save**.

QSS updates the QoS information.

Configuring DSCP Priority for QoS

DSCP (Differentiated Services Code Point) is a 6-bit field in a packet IP header that is used to classify a packet. The DSCP value determines which queue the packet is forwarded to, based on the priority assigned to the DSCP value (0-63).

1. Log in to QSS.
2. Go to **Configuration > QoS**.
3. Identify a port.
4. Click  under DSCP Inspection.
QSS enables DSCP inspection on the port.
5. Click **Edit DSCP Inspection**.
6. Assign a priority value between 1 and 8 to the DSCP value.

7. Click **Save**.
QSS updates the priority queue of the DSCP value.
8. Click **Save**.

QSS updates the QoS information.

Managing Access Control List (ACL) Entries

Access control lists allow you to handle network traffic in a switch by using controlled rule sets. Each ACL rule is specific to a user-created set of conditions that a data packet must meet to match the rule. In the instance that a data packet has no ACL rule match, the switch applies the default rule. Otherwise, the switch matches the data packet to the rule and permits or denies the packet.

You can use ACLs to control host access to different parts of a network or to control traffic forwarding or blocking at the switch level.

Adding an IP Address-based ACL Rule

1. Log in to QSS.
2. Go to **Configuration > ACL > By IP Address** .
3. Click **Add**.
The **Add ACL - IP Address** window opens.
4. Configure the ACL settings.

Setting	User Action
ACL No.	Specify a number between 1 and 255.
Source	
IP Address	Specify the source IP address.
Subnet Mask	Specify the source subnet mask.
Destination	
IP address	Specify the destination IP address.
Subnet Mask	Specify the destination subnet mask.
Port	Select specific ports to apply the ACL rule, or select All to apply the rule to all ports.
Permission	Select one of the following: <ul style="list-style-type: none"> • Allow • Deny

5. Click **Save**.

QSS adds the IP address-based ACL rule.

Adding a MAC Address-based ACL Rule

1. Log in to QSS.
2. Go to **Configuration > ACL > By MAC Address** .
3. Click **Add**.

The **Add ACL - MAC Address** window opens.

- Configure the ACL settings.

Setting	User Action
ACL No.	Specify a number between 1 and 255.
Source	
MAC address	Specify the source MAC address.
Destination	
MAC address	Specify the destination MAC address.
Port	Select specific ports to apply the ACL rule, or select All to apply the rule to all ports.
Permission	Select one of the following: <ul style="list-style-type: none"> Allow Deny

- Click **Save**.

QSS adds the MAC address-based ACL rule.

Deleting a Network Setting

- Log in to QSS.
- Go to **Configuration**.
- Select a network setting.



Note

Deleting network settings is applicable only to ACL rules, link aggregation groups, static MAC addresses, and VLANs.

- Click . A confirmation message appears.
- Click **Delete**.



QSS deletes the network setting.

Monitoring Network Settings

You can monitor the following network settings in the **Configuration** section. These settings can be used to monitor and diagnose switch operations.

- Log in to QSS.
- Go to **Configuration**.
- Select a network setting.

Setting	Description
IGMP Snooping Statistics	Go to IGMP Snooping > IGMP Snooping Statistics . Displays statistical information about detected IGMP groups.

Setting	Description
LLP Remote Devices	<p>Go to LLDP > LLP Remote Devices .</p> <p>Displays information about the LLDP-enabled port including system capabilities and remote management IP address.</p> <p>Possible system capabilities include:</p> <ul style="list-style-type: none"> • Bridge • DOCSIS cable device • Repeater • Reserved • Router • Station only • Telephone • WLAN access point • Other
Port Status	<p>Go to Port Management > Port Status to view the following port status information:</p> <ul style="list-style-type: none"> • Port number • Port link status • Port state • Port speed • Flow control
Port Statistics	<p>a. Go to Port Management > Port Statistics to view the statistics of the network ports.</p> <p>b.  Click  to change the viewing option to List View.</p>

System Management



The **System** section provides access to device configuration options.

System Settings

The **System Settings** menu contains system configuration options such as system information, IP information, password settings, secure connection settings, and time settings for the switch.

Changing the Switch Name

1. Log in to QSS.
2. Go to **System > System Settings > System Information** .
3. Click .

4. Specify the switch name.
Requirements:
 - Length: 1–14 characters
 - Valid characters: A–Z, a–z, 0–9
 - Valid special characters: Hyphen (-)
5.  Click  to confirm the switch name.

QSS updates the switch name.

Configuring the Switch IP Information

1. Log in to QSS.
2. Go to **System > System Settings > IP**.
3. Select a network configuration setting.

Setting	Description
Automatically obtain IP & DNS	If the network supports DHCP, the adapter automatically obtains the IP address and network settings.
Manually set the IP & DNS	<p>Manually assign a static IP address. You must specify the following information:</p> <ul style="list-style-type: none"> • Fixed IP Address • Subnet Mask • Default Gateway <p> Note The default gateway IP address for the switch is optional.</p>

4. Click **Save**.
A confirmation message appears.
5. Click **Yes**.

QSS updates the IP information.

 **Note**
Use Qfinder Pro to locate the switch and log in to QSS.

Updating the Switch Password

1. Log in to QSS.
2. Go to **System > System Settings > Password**.
3. Specify a new password.

**Tip**

Click  to make the password visible.

Setting	User Action
Current password	Specify the current password of the device.
New password	Specify a password that contains 8 to 20 ASCII characters.
Confirm new password	Reenter the new password.

4. Click **Save**.

QSS logs you out of the switch interface. You can access the switch with the new password.

Configuring Time Settings

**Note**

You must configure the system time correctly to ensure the following:

- When using a web browser to connect to the device or save a file, the displayed time of the action is correct.
- Event logs reflect the exact time that events occur.
- Scheduled tasks run at the correct time.

1. Log in to QSS.
2. Go to **System > System Settings > Time** .
3. Specify the time zone.
4. Specify the time configuration.

Setting	Description
Manual configuration	Specify the date and time.
Synchronize with internet time server	Ensure that your device is connected to the internet, and then specify the following information: Server: Specify the Network Time Protocol (NTP) server. Examples: time.nist.gov, time.windows.com

5. Click **Save**.

QSS updates the time settings.

Backing Up System Settings

1. Log in to QSS.
2. Go to **System > System Settings > Backup & Restore** .
3. Click **Backup**.

The device exports the system settings as a BIN file and downloads the file to your computer.

Restoring System Settings



Warning

If the selected backup file contains user or user group information that already exists on the device, the system will overwrite the existing information.

1. Log in to QSS.
2. Go to **System > System Settings > Backup & Restore** .
A file explorer window opens.
3. Click **Browse**.
4. Select a valid BIN file that contains the device system settings.
5. Click **Restore**.

QSS restores the switch settings.

Resetting the Switch Password

1. Log in to QSS.
2. Go to **System > System Settings > Factory Reset** .
3. Click **Password Reset**.

QSS resets the switch password.

Default Username	Default Password
admin	<p>The MAC address of the switch image omitting any punctuation and capitalizing any letters.</p> <div style="display: flex; align-items: flex-start;">  <div> <p>Tip</p> <p>For example, if the MAC address is 00:0a:0b:0c:00:01, the default password is 000A0B0C0001. You can find the MAC address using Qfinder Pro. It is also printed on a sticker on the device as "MAC".</p> </div> </div>

Resetting the Switch to Factory Settings

Resetting the switch deletes the data stored on the device and restores the switch to the default factory settings.



Tip

You can also reset the switch to factory defaults by pressing and holding the physical reset button for 10 seconds.

1. Log in to QSS.
2. Go to **System > System Settings > Factory Reset** .
3. Click **Factory Reset**.
A confirmation message appears.
4. Click **Yes**.

QSS resets the switch to the factory default settings.



Note

To log in to the interface again, you must locate the device using Qfinder Pro. For details, see [Switch Access](#).

Enabling Secure Connection (HTTPS)

1. Log in to QSS.
2. Go to **System > System Settings > HTTPS**.
3. Select **Enable Secure Connection (HTTPS)**.
4. Select a TLS version.



Note

Select the latest version of TLS to maximize system security. Ensure that your system meets the TLS requirements to avoid compatibility issues.

5. Optional: Select **Force secure connections (HTTPS) only**.



Note

After enabling this setting, you can only access the web administration page via HTTPS.

6. Click **Save**.

QSS saves the secure connection settings.

Restarting the Switch

1. Log in to QSS.
2. Click  located on the upper-right corner of the page.
3. Click **Restart Switch**.
A confirmation message appears.
4. Click **Yes**.

QSS restarts the switch.

Viewing the Switch Information

To view the hardware and system information of the switch, go to **System > System Information**.

The screen provides the following information.

Information	Description
Switch name	Displays the default or modified name of the device
Model name	Displays the model name of the switch
MAC address	Displays the MAC address of the switch image
IP address	Displays the DHCP or static IP address of the switch
System uptime	Displays how long the system has been operational

Information	Description
Current firmware version	Displays the firmware image version of the switch

Firmware Update



QNAP recommends keeping your device firmware up to date. This ensures that your device can benefit from new QSS software features, security updates, enhancements, and bug fixes.

You can update the switch firmware using one of the following methods:

Update Method	Description
Using Check for update .	Firmware updates are automatically detected by QSS and installed onto your device. For details, see Checking for Live Updates .
Using Firmware Update	You can check for firmware updates on the QNAP website , download updates to a computer, and manually install updates onto your device. For details, see Updating the Firmware Manually .

Firmware Requirements

Your device must meet the following requirements to perform a firmware update:

Settings	Requirements
Hardware settings	<ul style="list-style-type: none"> A computer <p> Note A computer is required when updating the firmware manually or using Qfinder Pro.</p> <p>Ethernet cables</p> <p> Note QNAP recommends updating the firmware using wired Ethernet connections to ensure your network connection remains stable during the firmware update process.</p>
Backup system settings	QNAP recommends backing up the system settings to your computer before updating the firmware. For details, see Backing Up System Settings .
Administrator privileges	You must be a switch administrator or have admin privileges to update the firmware.
Stop switch operations	QNAP recommends stopping all other switch operations before the firmware update. The switch must be restarted for the firmware update to take effect and may disrupt ongoing switch services or operations.
Device model name	Ensure you have the correct switch model name. You can find the switch model name using the following methods: <ul style="list-style-type: none"> Locate the model name on a sticker on the bottom or rear of your device. Go to Control Panel > System Status > System Information > Model name

Settings	Requirements
Firmware version	If you are updating the firmware using Firmware Update or Qfinder Pro, ensure the selected firmware version is correct for your device model.

Checking for Live Updates



Warning

- To prevent data loss, QNAP recommends backing up all data on your device before updating the firmware. For details about data backup, see [Backing Up System Settings](#).
- Do not power off your device during the firmware update process.



Important

- Make sure you review through the [Firmware Requirements](#) before updating the firmware.
- The update may require several minutes or longer, depending on your hardware configuration and network connection.

1. Log in to QSS.
2. Go to **System > Firmware Update > Live Update**.
3. Click **Check for update**.
QSS checks for available firmware updates. You can choose to update QSS if there is an available update.
4. Click **Update System**.
A confirmation message appears.
5. Click **Update**.

QSS updates the firmware.

Updating the Firmware Manually



Warning

- To prevent data loss, QNAP recommends backing up all data on your device before updating the firmware. For details about data backup, see [Backing Up System Settings](#).
- Do not power off your device during the firmware update process.



Important

- Make sure you review through the [Firmware Requirements](#) before updating the firmware.
- The update may require several minutes or longer, depending on your hardware configuration and network connection.

1. Download the device firmware.

- a. Go to <http://www.qnap.com/download>.
 - b. Select the product type.
 - c. Select your device model.
 - d. Read the release notes and confirm the following:
 - The device model matches the firmware version.
 - Updating the firmware is necessary.
 - Check for any additional firmware update setup instructions.
2. Ensure that the product model and firmware are correct.
 3. Select the download server based on your location.
 4. Download the firmware package.
 5. Click **Browse**.
 6. Select a folder.
 7. Save the downloaded firmware package.
 8. Extract the firmware image file.
 9. Log in to QSS.
 10. Go to **System > Firmware Update > Firmware Update** .
 11. Click **Browse** and then select the extracted firmware image file.
 12. Click **Update System**.
A confirmation message window appears.
 13. Click **Update**.

The device is restarted immediately.

Updating the Firmware Manually



Warning

- To prevent data loss, QNAP recommends backing up all data on your device before updating the firmware. For details about data backup, see .
- Do not power off your device during the firmware update process.



Important

- Make sure you review through the before updating the firmware.
- The update may require several minutes or longer, depending on your hardware configuration and network connection.

1. Download the device firmware.
 - a. Go to <http://www.qnap.com/download>.

5. Support and Other Resources

QNAP provides the following resources:

Resource	URL
Documentation	https://docs.qnap.com
Service Portal	https://service.qnap.com
Downloads	https://download.qnap.com
Community Forum	https://forum.qnap.com

6. Glossary

myQNAPcloud

Provides various remote access services such as DDNS and myQNAPcloud Link

Qfinder Pro

QNAP utility that lets you locate and access QNAP NAS devices in your local area network

QSS

QNAP switch management application

QuNetSwitch

QNAP switch management app that runs on the QTS operating system

7. Notices

This chapter provides information about warranty, disclaimers, licensing, and federal regulations.

Limited Warranty

QNAP offers limited warranty service on our products. Your QNAP-branded hardware product is warranted against defects in materials and workmanship for a period of one (1) year or more from the date printed on the invoice. ("Warranty Period"). Please review your statutory rights at www.qnap.com/warranty, which may be amended from time to time by QNAP in its discretion.

Disclaimer

Information in this document is provided in connection with products of QNAP Systems, Inc. (the "QNAP"). No license, express or implied, by estoppels or otherwise, to any intellectual property rights is granted by this document. Except as provided in QNAP's terms and conditions of sale for such products, QNAP assumes no liability whatsoever, and QNAP disclaims any express or implied warranty, relating to sale and/or use of QNAP products including liability or warranties relating to fitness for a particular purpose, merchantability, or infringement of any patent, copyright or other intellectual property right.

QNAP products are not intended for use in medical, life saving, life sustaining, critical control or safety systems, or in nuclear facility applications.

In no event shall QNAP's liability exceed the price paid for the product from direct, indirect, special, incidental, or consequential damages resulting from the use of the product, its accompanying software, or its documentation. QNAP makes no warranty or representation, expressed, implied, or statutory, with respect to its products or the contents or use of this documentation and all accompanying software, and specifically disclaims its quality, performance, merchantability, or fitness for any particular purpose. QNAP reserves the right to revise or update its products, software, or documentation without obligation to notify any individual or entity.

Back up the system periodically to avoid any potential data loss is recommended. QNAP disclaims any responsibility of all sorts of data loss or recovery.

Should you return any components of the package of QNAP products such as NAS (Network Attached Storage) for refund or maintenance, make sure they are carefully packed for shipping. Any form of damages due to improper packaging will not be compensated.

All the features, functionality, and other product specifications are subject to change without prior notice or obligation. Information contained herein is subject to change without notice.

Further, the ® or ™ symbols are not used in the text.

GNU Public License

Version 3, 29 June 2007

Everyone is permitted to copy and distribute verbatim copies of this license document, but changing it is not allowed.

Preamble

The GNU General Public License is a free, copy left license for software and other kinds of works.

The licenses for most software and other practical works are designed to take away your freedom to share and change the works. By contrast, the GNU General Public License is intended to guarantee your freedom to share and change all versions of a program--to make sure it remains free software for all its users. We,

the Free Software Foundation, use the GNU General Public License for most of our software; it applies also to any other work released this way by its authors. You can apply it to your programs, too.

When we speak of free software, we are referring to freedom, not price. Our General Public Licenses are designed to make sure that you have the freedom to distribute copies of free software (and charge for them if you wish), that you receive source code or can get it if you want it, that you can change the software or use pieces of it in new free programs, and that you know you can do these things.

To protect your rights, we need to prevent others from denying you these rights or asking you to surrender the rights. Therefore, you have certain responsibilities if you distribute copies of the software, or if you modify it: responsibilities to respect the freedom of others.

For example, if you distribute copies of such a program, whether gratis or for a fee, you must pass on to the recipients the same freedoms that you received. You must make sure that they, too, receive or can get the source code. And you must show them these terms so they know their rights.

Developers that use the GNU GPL protect your rights with two steps: (1) assert copyright on the software, and (2) offer you this License giving you legal permission to copy, distribute and/or modify it.

For the developers' and authors' protection, the GPL clearly explains that there is no warranty for this free software. For both users' and authors' sake, the GPL requires that modified versions be marked as changed, so that their problems will not be attributed erroneously to authors of previous versions.

Some devices are designed to deny users access to install or run modified versions of the software inside them, although the manufacturer can do so. This is fundamentally incompatible with the aim of protecting users' freedom to change the software. The systematic pattern of such abuse occurs in the area of products for individuals to use, which is precisely where it is most unacceptable. Therefore, we have designed this version of the GPL to prohibit the practice for those products. If such problems arise substantially in other domains, we stand ready to extend this provision to those domains in future versions of the GPL, as needed to protect the freedom of users.

Finally, every program is threatened constantly by software patents. States should not allow patents to restrict development and use of software on general-purpose computers, but in those that do, we wish to avoid the special danger that patents applied to a free program could make it effectively proprietary. To prevent this, the GPL assures that patents cannot be used to render the program non-free.

The precise terms and conditions for copying, distribution and modification follow.

Terms and Conditions

1. Definitions.

"This License" refers to version 3 of the GNU General Public License.

"Copyright" also means copyright-like laws that apply to other kinds of works, such as semiconductor masks.

"The Program" refers to any copyrightable work licensed under this License. Each licensee is addressed as "you". "Licensees" and "recipients" may be individuals or organizations.

To "modify" a work means to copy from or adapt all or part of the work in a fashion requiring copyright permission, other than the making of an exact copy. The resulting work is called a "modified version" of the earlier work or a work "based on" the earlier work.

A "covered work" means either the unmodified Program or a work based on the Program.

To "propagate" a work means to do anything with it that, without permission, would make you directly or secondarily liable for infringement under applicable copyright law, except executing it on a computer or modifying a private copy. Propagation includes copying, distribution (with or without modification), making available to the public, and in some countries other activities as well.

To "convey" a work means any kind of propagation that enables other parties to make or receive copies. Mere interaction with a user through a computer network, with no transfer of a copy, is not conveying.

An interactive user interface displays "Appropriate Legal Notices" to the extent that it includes a convenient and prominently visible feature that (1) displays an appropriate copyright notice, and (2)

tells the user that there is no warranty for the work (except to the extent that warranties are provided), that licensees may convey the work under this License, and how to view a copy of this License. If the interface presents a list of user commands or options, such as a menu, a prominent item in the list meets this criterion.

2. Source Code.

The “source code” for a work means the preferred form of the work for making modifications to it.

“Object code” means any non-source form of a work.

A “Standard Interface” means an interface that either is an official standard defined by a recognized standards body, or, in the case of interfaces specified for a particular programming language, one that is widely used among developers working in that language.

The “System Libraries” of an executable work include anything, other than the work as a whole, that (a) is included in the normal form of packaging a Major Component, but which is not part of that Major Component, and (b) serves only to enable use of the work with that Major Component, or to implement a Standard Interface for which an implementation is available to the public in source code form. A “Major Component”, in this context, means a major essential component (kernel, window system, and so on) of the specific operating system (if any) on which the executable work runs, or a compiler used to produce the work, or an object code interpreter used to run it.

The “Corresponding Source” for a work in object code form means all the source code needed to generate, install, and (for an executable work) run the object code and to modify the work, including scripts to control those activities. However, it does not include the work’s System Libraries, or general-purpose tools or generally available free programs which are used unmodified in performing those activities but which are not part of the work. For example, Corresponding Source includes interface definition files associated with source files for the work, and the source code for shared libraries and dynamically linked subprograms that the work is specifically designed to require, such as by intimate data communication or control flow between those subprograms and other parts of the work.

The Corresponding Source need not include anything that users can regenerate automatically from other parts of the Corresponding Source.

The Corresponding Source for a work in source code form is that same work.

3. Basic Permissions.

All rights granted under this License are granted for the term of copyright on the Program, and are irrevocable provided the stated conditions are met. This License explicitly affirms your unlimited permission to run the unmodified Program. The output from running a covered work is covered by this License only if the output, given its content, constitutes a covered work. This License acknowledges your rights of fair use or other equivalent, as provided by copyright law.

You may make, run and propagate covered works that you do not convey, without conditions so long as your license otherwise remains in force. You may convey covered works to others for the sole purpose of having them make modifications exclusively for you, or provide you with facilities for running those works, provided that you comply with the terms of this License in conveying all material for which you do not control copyright. Those thus making or running the covered works for you must do so exclusively on your behalf, under your direction and control, on terms that prohibit them from making any copies of your copyrighted material outside their relationship with you.

Conveying under any other circumstances is permitted solely under the conditions stated below.

Sublicensing is not allowed; section 10 makes it unnecessary.

4. Protecting Users' Legal Rights From Anti-Circumvention Law.

No covered work shall be deemed part of an effective technological measure under any applicable law fulfilling obligations under article 11 of the WIPO copyright treaty adopted on 20 December 1996, or similar laws prohibiting or restricting circumvention of such measures.

When you convey a covered work, you waive any legal power to forbid circumvention of technological measures to the extent such circumvention is effected by exercising rights under this License with respect to the covered work, and you disclaim any intention to limit operation or modification of the work as a means of enforcing, against the work’s users, your or third parties’ legal rights to forbid circumvention of technological measures.

5. Conveying Verbatim Copies.

You may convey verbatim copies of the Program's source code as you receive it, in any medium, provided that you conspicuously and appropriately publish on each copy an appropriate copyright notice; keep intact all notices stating that this License and any non-permissive terms added in accord with section 7 apply to the code; keep intact all notices of the absence of any warranty; and give all recipients a copy of this License along with the Program.

You may charge any price or no price for each copy that you convey, and you may offer support or warranty protection for a fee.

6. Conveying Modified Source Versions.

You may convey a work based on the Program, or the modifications to produce it from the Program, in the form of source code under the terms of section 4, provided that you also meet all of these conditions:

- a. The work must carry prominent notices stating that you modified it, and giving a relevant date.
- b. The work must carry prominent notices stating that it is released under this License and any conditions added under section 7. This requirement modifies the requirement in section 4 to "keep intact all notices".
- c. You must license the entire work, as a whole, under this License to anyone who comes into possession of a copy. This License will therefore apply, along with any applicable section 7 additional terms, to the whole of the work, and all its parts, regardless of how they are packaged. This License gives no permission to license the work in any other way, but it does not invalidate such permission if you have separately received it.
- d. If the work has interactive user interfaces, each must display Appropriate Legal Notices; however, if the Program has interactive interfaces that do not display Appropriate Legal Notices, your work need not make them do so.
A compilation of a covered work with other separate and independent works, which are not by their nature extensions of the covered work, and which are not combined with it such as to form a larger program, in or on a volume of a storage or distribution medium, is called an "aggregate" if the compilation and its resulting copyright are not used to limit the access or legal rights of the compilation's users beyond what the individual works permit. Inclusion of a covered work in an aggregate does not cause this License to apply to the other parts of the aggregate.

7. Conveying Non-Source Forms.

You may convey a covered work in object code form under the terms of sections 4 and 5, provided that you also convey the machine-readable Corresponding Source under the terms of this License, in one of these ways:

- a. Convey the object code in, or embodied in, a physical product (including a physical distribution medium), accompanied by the Corresponding Source fixed on a durable physical medium customarily used for software interchange.
- b. Convey the object code in, or embodied in, a physical product (including a physical distribution medium), accompanied by a written offer, valid for at least three years and valid for as long as you offer spare parts or customer support for that product model, to give anyone who possesses the object code either (1) a copy of the Corresponding Source for all the software in the product that is covered by this License, on a durable physical medium customarily used for software interchange, for a price no more than your reasonable cost of physically performing this conveying of source, or (2) access to copy the Corresponding Source from a network server at no charge.
- c. Convey individual copies of the object code with a copy of the written offer to provide the Corresponding Source. This alternative is allowed only occasionally and noncommercially, and only if you received the object code with such an offer, in accord with subsection 6b.
- d. Convey the object code by offering access from a designated place (gratis or for a charge), and offer equivalent access to the Corresponding Source in the same way through the same place

at no further charge. You need not require recipients to copy the Corresponding Source along with the object code. If the place to copy the object code is a network server, the Corresponding Source may be on a different server (operated by you or a third party) that supports equivalent copying facilities, provided you maintain clear directions next to the object code saying where to find the Corresponding Source. Regardless of what server hosts the Corresponding Source, you remain obligated to ensure that it is available for as long as needed to satisfy these requirements.

- e. Convey the object code using peer-to-peer transmission, provided you inform other peers where the object code and Corresponding Source of the work are being offered to the general public at no charge under subsection 6d.

A separable portion of the object code, whose source code is excluded from the Corresponding Source as a System Library, need not be included in conveying the object code work.

A "User Product" is either (1) a "consumer product", which means any tangible personal property which is normally used for personal, family, or household purposes, or (2) anything designed or sold for incorporation into a dwelling. In determining whether a product is a consumer product, doubtful cases shall be resolved in favor of coverage. For a particular product received by a particular user, "normally used" refers to a typical or common use of that class of product, regardless of the status of the particular user or of the way in which the particular user actually uses, or expects or is expected to use, the product. A product is a consumer product regardless of whether the product has substantial commercial, industrial or non-consumer uses, unless such uses represent the only significant mode of use of the product.

"Installation Information" for a User Product means any methods, procedures, authorization keys, or other information required to install and execute modified versions of a covered work in that User Product from a modified version of its Corresponding Source. The information must suffice to ensure that the continued functioning of the modified object code is in no case prevented or interfered with solely because modification has been made.

If you convey an object code work under this section in, or with, or specifically for use in, a User Product, and the conveying occurs as part of a transaction in which the right of possession and use of the User Product is transferred to the recipient in perpetuity or for a fixed term (regardless of how the transaction is characterized), the Corresponding Source conveyed under this section must be accompanied by the Installation Information. But this requirement does not apply if neither you nor any third party retains the ability to install modified object code on the User Product (for example, the work has been installed in ROM).

The requirement to provide Installation Information does not include a requirement to continue to provide support service, warranty, or updates for a work that has been modified or installed by the recipient, or for the User Product in which it has been modified or installed. Access to a network may be denied when the modification itself materially and adversely affects the operation of the network or violates the rules and protocols for communication across the network.

Corresponding Source conveyed, and Installation Information provided, in accord with this section must be in a format that is publicly documented (and with an implementation available to the public in source code form), and must require no special password or key for unpacking, reading or copying.

8. Additional Terms.

"Additional permissions" are terms that supplement the terms of this License by making exceptions from one or more of its conditions. Additional permissions that are applicable to the entire Program shall be treated as though they were included in this License, to the extent that they are valid under applicable law. If additional permissions apply only to part of the Program, that part may be used separately under those permissions, but the entire Program remains governed by this License without regard to the additional permissions.

When you convey a copy of a covered work, you may at your option remove any additional permissions from that copy, or from any part of it. (Additional permissions may be written to require their own removal in certain cases when you modify the work.) You may place additional permissions on material, added by you to a covered work, for which you have or can give appropriate copyright permission.

Notwithstanding any other provision of this License, for material you add to a covered work, you may (if authorized by the copyright holders of that material) supplement the terms of this License with terms:

- a. Disclaiming warranty or limiting liability differently from the terms of sections 15 and 16 of this License; or
- b. Requiring preservation of specified reasonable legal notices or author attributions in that material or in the Appropriate Legal Notices displayed by works containing it; or
- c. Prohibiting misrepresentation of the origin of that material, or requiring that modified versions of such material be marked in reasonable ways as different from the original version; or
- d. Limiting the use for publicity purposes of names of licensors or authors of the material; or
- e. Declining to grant rights under trademark law for use of some trade names, trademarks, or service marks; or
- f. Requiring indemnification of licensors and authors of that material by anyone who conveys the material (or modified versions of it) with contractual assumptions of liability to the recipient, for any liability that these contractual assumptions directly impose on those licensors and authors. All other non-permissive additional terms are considered “further restrictions” within the meaning of section 10. If the Program as you received it, or any part of it, contains a notice stating that it is governed by this License along with a term that is a further restriction, you may remove that term. If a license document contains a further restriction but permits relicensing or conveying under this License, you may add to a covered work material governed by the terms of that license document, provided that the further restriction does not survive such relicensing or conveying.

If you add terms to a covered work in accord with this section, you must place, in the relevant source files, a statement of the additional terms that apply to those files, or a notice indicating where to find the applicable terms.

Additional terms, permissive or non-permissive, may be stated in the form of a separately written license, or stated as exceptions; the above requirements apply either way.

9. Termination.

You may not propagate or modify a covered work except as expressly provided under this License. Any attempt otherwise to propagate or modify it is void, and will automatically terminate your rights under this License (including any patent licenses granted under the third paragraph of section 11).

However, if you cease all violation of this License, then your license from a particular copyright holder is reinstated (a) provisionally, unless and until the copyright holder explicitly and finally terminates your license, and (b) permanently, if the copyright holder fails to notify you of the violation by some reasonable means prior to 60 days after the cessation.

Moreover, your license from a particular copyright holder is reinstated permanently if the copyright holder notifies you of the violation by some reasonable means, this is the first time you have received notice of violation of this License (for any work) from that copyright holder, and you cure the violation prior to 30 days after your receipt of the notice.

Termination of your rights under this section does not terminate the licenses of parties who have received copies or rights from you under this License. If your rights have been terminated and not permanently reinstated, you do not qualify to receive new licenses for the same material under section 10.

10. Acceptance Not Required for Having Copies.

You are not required to accept this License in order to receive or run a copy of the Program. Ancillary propagation of a covered work occurring solely as a consequence of using peer-to-peer transmission to receive a copy likewise does not require acceptance. However, nothing other than this License grants you permission to propagate or modify any covered work. These actions infringe copyright if you do not accept this License. Therefore, by modifying or propagating a covered work, you indicate your acceptance of this License to do so.

11. Automatic Licensing of Downstream Recipients.

Each time you convey a covered work, the recipient automatically receives a license from the original licensors, to run, modify and propagate that work, subject to this License. You are not responsible for enforcing compliance by third parties with this License.

An "entity transaction" is a transaction transferring control of an organization, or substantially all assets of one, or subdividing an organization, or merging organizations. If propagation of a covered work results from an entity transaction, each party to that transaction who receives a copy of the work also receives whatever licenses to the work the party's predecessor in interest had or could give under the previous paragraph, plus a right to possession of the Corresponding Source of the work from the predecessor in interest, if the predecessor has it or can get it with reasonable efforts.

You may not impose any further restrictions on the exercise of the rights granted or affirmed under this License. For example, you may not impose a license fee, royalty, or other charge for exercise of rights granted under this License, and you may not initiate litigation (including a cross-claim or counterclaim in a lawsuit) alleging that any patent claim is infringed by making, using, selling, offering for sale, or importing the Program or any portion of it.

12. Patents.

A "contributor" is a copyright holder who authorizes use under this License of the Program or a work on which the Program is based. The work thus licensed is called the contributor's "contributor version". A contributor's "essential patent claims" are all patent claims owned or controlled by the contributor, whether already acquired or hereafter acquired, that would be infringed by some manner, permitted by this License, of making, using, or selling its contributor version, but do not include claims that would be infringed only as a consequence of further modification of the contributor version. For purposes of this definition, "control" includes the right to grant patent sublicenses in a manner consistent with the requirements of this License.

Each contributor grants you a non-exclusive, worldwide, royalty-free patent license under the contributor's essential patent claims, to make, use, sell, offer for sale, import and otherwise run, modify and propagate the contents of its contributor version.

In the following three paragraphs, a "patent license" is any express agreement or commitment, however denominated, not to enforce a patent (such as an express permission to practice a patent or covenant not to sue for patent infringement). To "grant" such a patent license to a party means to make such an agreement or commitment not to enforce a patent against the party.

If you convey a covered work, knowingly relying on a patent license, and the Corresponding Source of the work is not available for anyone to copy, free of charge and under the terms of this License, through a publicly available network server or other readily accessible means, then you must either (1) cause the Corresponding Source to be so available, or (2) arrange to deprive yourself of the benefit of the patent license for this particular work, or (3) arrange, in a manner consistent with the requirements of this License, to extend the patent license to downstream recipients. "Knowingly relying" means you have actual knowledge that, but for the patent license, your conveying the covered work in a country, or your recipient's use of the covered work in a country, would infringe one or more identifiable patents in that country that you have reason to believe are valid.

If, pursuant to or in connection with a single transaction or arrangement, you convey, or propagate by procuring conveyance of, a covered work, and grant a patent license to some of the parties receiving the covered work authorizing them to use, propagate, modify or convey a specific copy of the covered work, then the patent license you grant is automatically extended to all recipients of the covered work and works based on it.

A patent license is "discriminatory" if it does not include within the scope of its coverage, prohibits the exercise of, or is conditioned on the non-exercise of one or more of the rights that are specifically granted under this License. You may not convey a covered work if you are a party to an arrangement with a third party that is in the business of distributing software, under which you make payment to the third party based on the extent of your activity of conveying the work, and under which the third party grants, to any of the parties who would receive the covered work from you, a discriminatory patent license (a) in connection with copies of the covered work conveyed by you (or copies made from those copies), or (b) primarily for and in connection with specific products or compilations that contain the covered work, unless you entered into that arrangement, or that patent license was granted, prior to 28 March 2007.

Nothing in this License shall be construed as excluding or limiting any implied license or other defenses to infringement that may otherwise be available to you under applicable patent law.

13. No Surrender of Others' Freedom.

If conditions are imposed on you (whether by court order, agreement or otherwise) that contradict the conditions of this License, they do not excuse you from the conditions of this License. If you cannot convey a covered work so as to satisfy simultaneously your obligations under this License and any other pertinent obligations, then as a consequence you may not convey it at all. For example, if you agree to terms that obligate you to collect a royalty for further conveying from those to whom you convey the Program, the only way you could satisfy both those terms and this License would be to refrain entirely from conveying the Program.

14. Use with the GNU Affero General Public License.

Notwithstanding any other provision of this License, you have permission to link or combine any covered work with a work licensed under version 3 of the GNU Affero General Public License into a single combined work, and to convey the resulting work. The terms of this License will continue to apply to the part which is the covered work, but the special requirements of the GNU Affero General Public License, section 13, concerning interaction through a network will apply to the combination as such.

15. Revised Versions of this License.

The Free Software Foundation may publish revised and/or new versions of the GNU General Public License from time to time. Such new versions will be similar in spirit to the present version, but may differ in detail to address new problems or concerns.

Each version is given a distinguishing version number. If the Program specifies that a certain numbered version of the GNU General Public License "or any later version" applies to it, you have the option of following the terms and conditions either of that numbered version or of any later version published by the Free Software Foundation. If the Program does not specify a version number of the GNU General Public License, you may choose any version ever published by the Free Software Foundation.

If the Program specifies that a proxy can decide which future versions of the GNU General Public License can be used, that proxy's public statement of acceptance of a version permanently authorizes you to choose that version for the Program.

Later license versions may give you additional or different permissions. However, no additional obligations are imposed on any author or copyright holder as a result of your choosing to follow a later version.

16. Disclaimer of Warranty.

THERE IS NO WARRANTY FOR THE PROGRAM, TO THE EXTENT PERMITTED BY APPLICABLE LAW. EXCEPT WHEN OTHERWISE STATED IN WRITING THE COPYRIGHT HOLDERS AND/OR OTHER PARTIES PROVIDE THE PROGRAM "AS IS" WITHOUT WARRANTY OF ANY KIND, EITHER EXPRESSED OR IMPLIED, INCLUDING, BUT NOT LIMITED TO, THE IMPLIED WARRANTIES OF MERCHANTABILITY AND FITNESS FOR A PARTICULAR PURPOSE. THE ENTIRE RISK AS TO THE QUALITY AND PERFORMANCE OF THE PROGRAM IS WITH YOU. SHOULD THE PROGRAM PROVE DEFECTIVE, YOU ASSUME THE COST OF ALL NECESSARY SERVICING, REPAIR OR CORRECTION.

17. Limitation of Liability.

IN NO EVENT UNLESS REQUIRED BY APPLICABLE LAW OR AGREED TO IN WRITING WILL ANY COPYRIGHT HOLDER, OR ANY OTHER PARTY WHO MODIFIES AND/OR CONVEYS THE PROGRAM AS PERMITTED ABOVE, BE LIABLE TO YOU FOR DAMAGES, INCLUDING ANY GENERAL, SPECIAL, INCIDENTAL OR CONSEQUENTIAL DAMAGES ARISING OUT OF THE USE OR INABILITY TO USE THE PROGRAM (INCLUDING BUT NOT LIMITED TO LOSS OF DATA OR DATA BEING RENDERED INACCURATE OR LOSSES SUSTAINED BY YOU OR THIRD PARTIES OR A FAILURE OF THE PROGRAM TO OPERATE WITH ANY OTHER PROGRAMS), EVEN IF SUCH HOLDER OR OTHER PARTY HAS BEEN ADVISED OF THE POSSIBILITY OF SUCH DAMAGES.

18. Interpretation of Sections 16 and 17.

If the disclaimer of warranty and limitation of liability provided above cannot be given local legal effect according to their terms, reviewing courts shall apply local law that most closely approximates an absolute waiver of all civil liability in connection with the Program, unless a warranty or assumption of liability accompanies a copy of the Program in return for a fee.

END OF TERMS AND CONDITIONS

CE Notice



This device complies with CE Compliance Class B.

FCC Notice

FCC Class B Notice



This device complies with Part 15 of the FCC Rules. Operation is subject to the following two conditions:

1. This device may not cause harmful interference.
2. This device must accept any interference received, including interference that may cause undesired operation.



Note

This equipment has been tested and found to comply with the limits for a Class B digital device, pursuant to Part 15 of the FCC Rules. These limits are designed to provide reasonable protection against harmful interference in a residential installation. This equipment generates, uses, and can radiate radio frequency energy and, if not installed and used in accordance with the instructions, may cause harmful interference to radio communications. However, there is no guarantee that interference will not occur in a particular installation. If this equipment does cause harmful interference to radio or television reception, which can be determined by turning the equipment off and on, the user is encouraged to try to correct the interference by one or more of the following measures:

- Reorient or relocate the receiving antenna.
- Increase the separation between the equipment and receiver.
- Connect the equipment into an outlet on a circuit different from that to which the receiver is connected.
- Consult the dealer or an experienced radio/television technician for help.



Important

Any modifications made to this device that are not approved by QNAP Systems, Inc. may void the authority granted to the user by the FCC to operate this equipment.

VCCI Notice

VCCI-B

BSMI Notice**SJ/T 11364-2006**

本产品符合中国 RoHS 标准。以下表格标示此产品中某有毒物质的含量符合中国 RoHS 标准规定的限量要求。

本产品上会附有“环境友好使用期限”的标签，此期限是估算这些物质“不会有泄漏或突变”的年限。本产品可能包含有较短的环境友好使用期限的可替换元件，像是电池或灯管，这些元件将会单独标示出来。

部件名称	有毒有害物质或元素					
	铅 (Pb)	汞 (Hg)	镉 (Cd)	六价铬 (CR(VI))	多溴联苯 (PBB)	多溴二苯醚 (PBDE)
壳体	0	0	0	0	0	0
显示	0	0	0	0	0	0
印刷电路板	0	0	0	0	0	0
金属螺帽	0	0	0	0	0	0
电缆组装	0	0	0	0	0	0
风扇组装	0	0	0	0	0	0
电力供应组装	0	0	0	0	0	0
电池	0	0	0	0	0	0

O: 表示该有毒有害物质在该部件所有物质材料中的含量均在 SJ/T11363-2006 标准规定的限量要求以下。

部件名称	有毒有害物质或元素					
	铅 (Pb)	汞 (Hg)	镉 (Cd)	六价铬 (CR(VI))	多溴联苯 (PBB)	多溴二苯醚 (PBDE)
X: 表示该有毒有害物质至少在该部件的某一均质材料中的含量超出 SJ/T11363-2006 标准规定的限量要求。						

EU Directive 2002/96/EC Waste Electronic and Electrical Equipment (WEEE)



According to the requirement of the WEEE legislation the following user information is provided to customers for all branded QNAP Electronics products subject to the WEEE directive.

This symbol on the product or on its packaging indicates that this product must not be disposed of with your other household waste. Instead, it is your responsibility to dispose of your waste equipment by handing it over to a designated collection point for the recycling of waste electrical and electronic equipment. The separate collection and recycling of your waste equipment at the time of disposal will help to conserve natural resources and ensure that it is recycled in a manner that protects human health and the environment. For more information about where you can drop off your waste equipment for recycling, please contact your local city office, your household waste disposal service or the shop where you purchased the product.

EU RoHS Statement

This equipment complies with the European Union RoHS Directive 2011/65/EU on the restriction of the use of certain hazardous substances in electrical and electronic equipment. The directive applies to the use of lead, mercury, cadmium, hexavalent chromium, polybrominated biphenyls (PBB), and polybrominated diphenyl ethers (PBDE) in electrical and electronic equipment.

Laser Compliance Notice

Make sure the fiber-optic Small Form-factor Pluggable (SFP) module complies with CNS 15016-2 or IEC 60852-1 certifications and Class 1 Laser specifications.

使用光纖可插拔 (SFP) 模組時，請確保它通過了 CNS 15016-2 或 IEC 60825-1 認證和 1 類激光產品。

UKCA Notice



This device complies with the UKCA requirements for products sold in Great Britain.