

## DS-D5B75RB/C Interactive Flat Panel



The Conference Flat Panel (hereafter referred to as the “device”) integrates functions of computers, projectors, interactive whiteboards, sound boxes, cameras (optional), bluetooth remote control (optional), HDTVs, advertising machines and so on. The device integrates technologies like 4K display, infrared touch, human-machine interaction, multi-media information processing, and network transmission and provides users with various features such as writing, annotating, multi-screen sharing, pen detection and remote video call (optional). The Conference Flat Panel is mainly used for remote video conferences, trainings and guidance, medical consulting, and other events in kinds of offices, meeting rooms, multi-media classrooms, exhibition halls and so on.

- Ultra HD display with up to 3840 × 2160 resolution of input signal available.
- 20px ultra fine writing, and 2 mm diameter recognizable with the precision of 1 mm.
- Built-in Wi-Fi realizes miracasting without any cable connection.
- Built-in interactive whiteboard system allows annotating and sharing by QR code.
- Looping-out display available.
- Various audio and video interfaces for device access.
- Built-in network switch chip saves a network switch.
- Built-in Android system provides kinds of applications.
- Compatible with OPS/OPS-C devices, realizing smooth switch between built-in systems.
- Ultra-thin design with aluminum profile frame.

## ▪ Specification

Product Model	
Product Model	DS-D5B75RB/C
Display	
Screen Size	75 inch LED Backlight
Backlight	DLED
Pixel Pitch	0.143 (H) × 0.430 (V) mm
Resolution	3840 × 2160@60 Hz
Brightness	350 cd/m <sup>2</sup>
Color Depth	10 bit
Contrast Ratio	1200 : 1 (Typ.)
Response Time	6 ms
Color Gamut	90% NTSC (CIE1931) (Typ.)
Refresh Rate	60 Hz
Viewing Angle	178° (H) / 178° (V)
Built-in System	
Operation System	Android 11
Processor	A72*2 + A53*4, 1.8 GHz
Memory	4 GB
Built-in Storage	64 GB
NIC	Built-in 1000 Mbps NIC, supporting routing; IEEE 802.11 a/b/g/n/ac with 2 × 2 MIMO, supporting both 2.4 GHz and 5GHz bands
Touch	
Type	Infrared touch screen
Glass	AG smooth glass
Touch Point	Max 45 point multi-touch
Touch Response Time	< 10 ms
Touch Precision	± 1 mm (≥ 90% touching area)
Internal Function	
Loudspeaker	Built-in 2 × 16 W loudspeaker
Bluetooth	Built-in BLE (Bluetooth Low Energy) module supports Bluetooth 5.0 and previous version
Interface	
Video & Audio Input	HDMI IN × 2, MAX 4K @30 Hz, LINE IN × 1
Video & audio output	HDMI OUT (HDMI 2.0) × 1, MAX 4K @60 Hz, LINE OUT × 1
Control interface	RS-232 × 1, Touch-USB × 1
Network Interface	RJ45 (1000 Mbps port) × 2
Data Transmission Interface	USB-C × 1, USB-A × 2 on front panel, USB-A × 2 on rear panel
Power	
Power Consumption	≤ 370 W (full load)
Standby Consumption	0.5 W
Working Environment	
Working Temperature	0 °C to 40 °C (32 °F to 104 °F)

Working Humidity	10% to 90% RH
<b>General</b>	
Power	100 to 240 V, AC, 50/60 Hz
Product dimensions	1718 × 1046 × 87.5 mm
Package Dimensions (W × H × D)	1927 × 1212 × 254 mm
Net Weight	51.75 kg
Gross Weight	68.56 kg
Lifespan	50000 hours

## Physical Interface

Interface	Description	Interface	Description
1.LINE OUT	Earphone Interface	2.LINE IN	Audio Input Interface
3.RS-232	RS-232 Serial Port	4.TOUCH-USB	Peripheral Touch Interface
5.LAN 2	Ethernet Interface 2	6. LAN 1	Ethernet Interface 1
7.HDMI 2	HDMI Input Interface 2	8.HDMI 1	HDMI Input Interface 1
9.USB 3.0	USB 3.0 Interface	10.MULTI-USB	Multi-functional USB Interface
11.HDMI OUT	HDMI Output Interface		

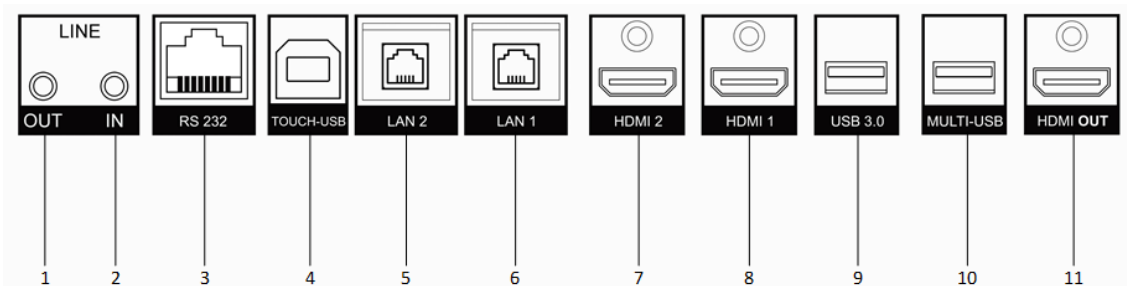

## Installation

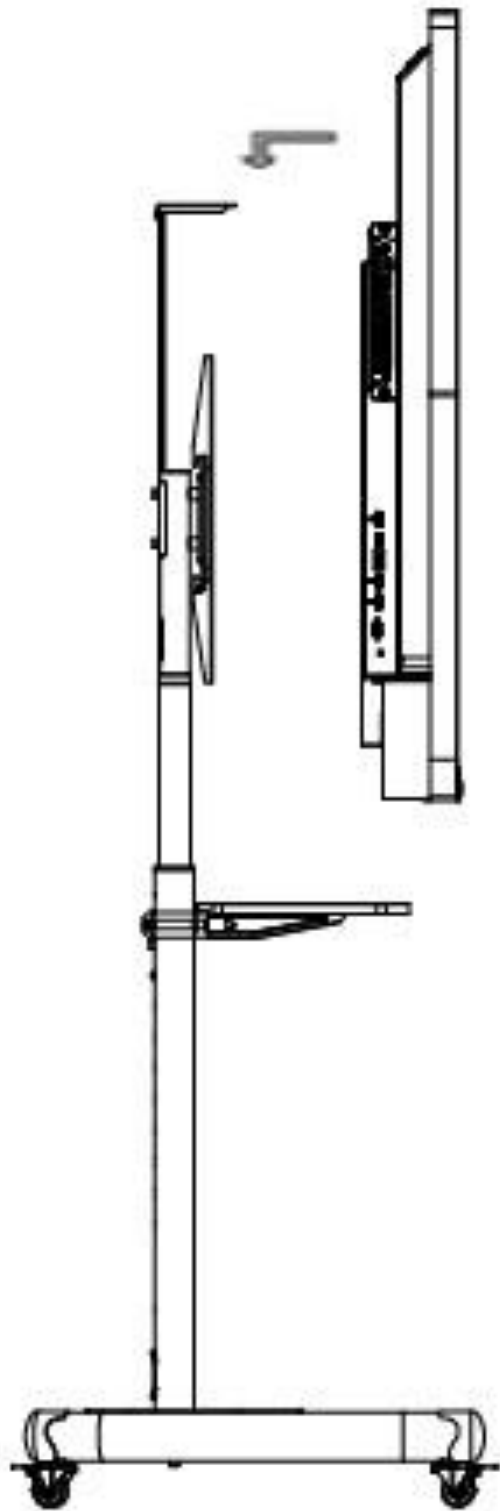

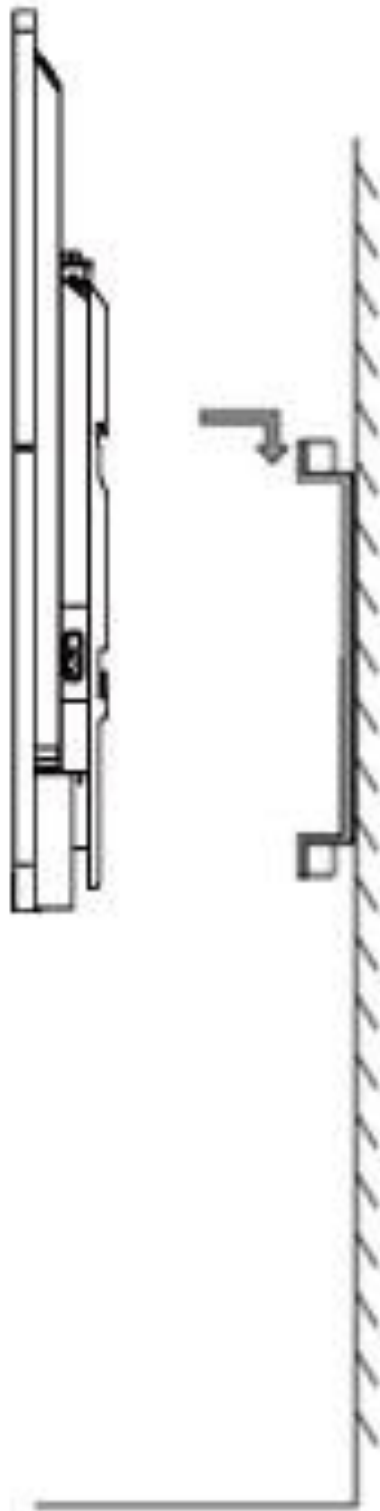

The rear should be installed on the hook holes

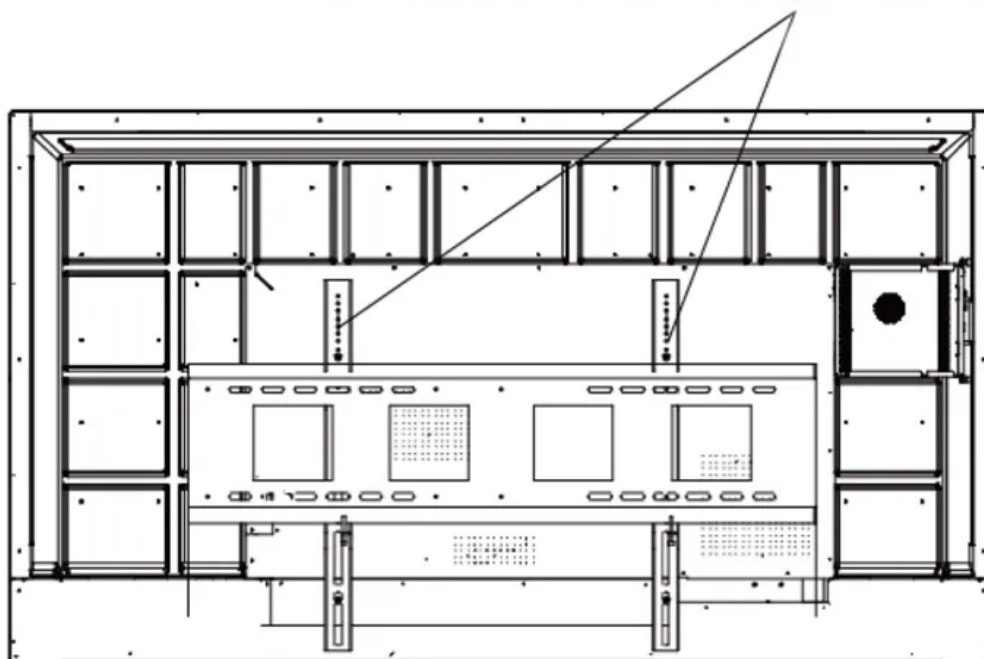

▪ Available Model

DS-D5B75RB/C(海外标配),DS-D5B75RB/C(海外标配)

▪ Dimension

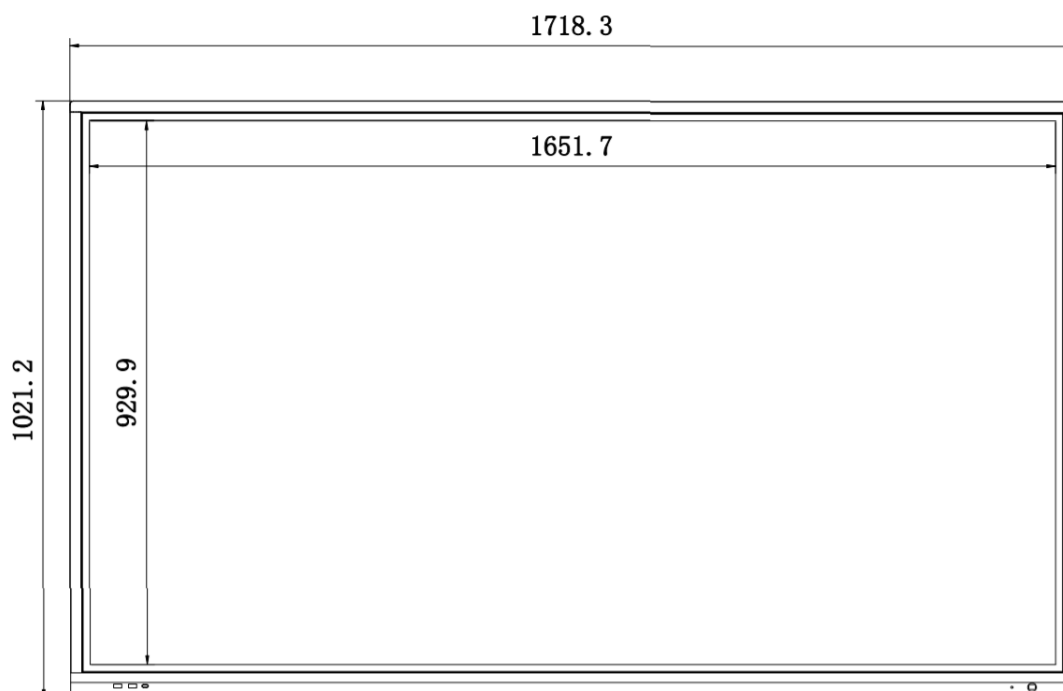

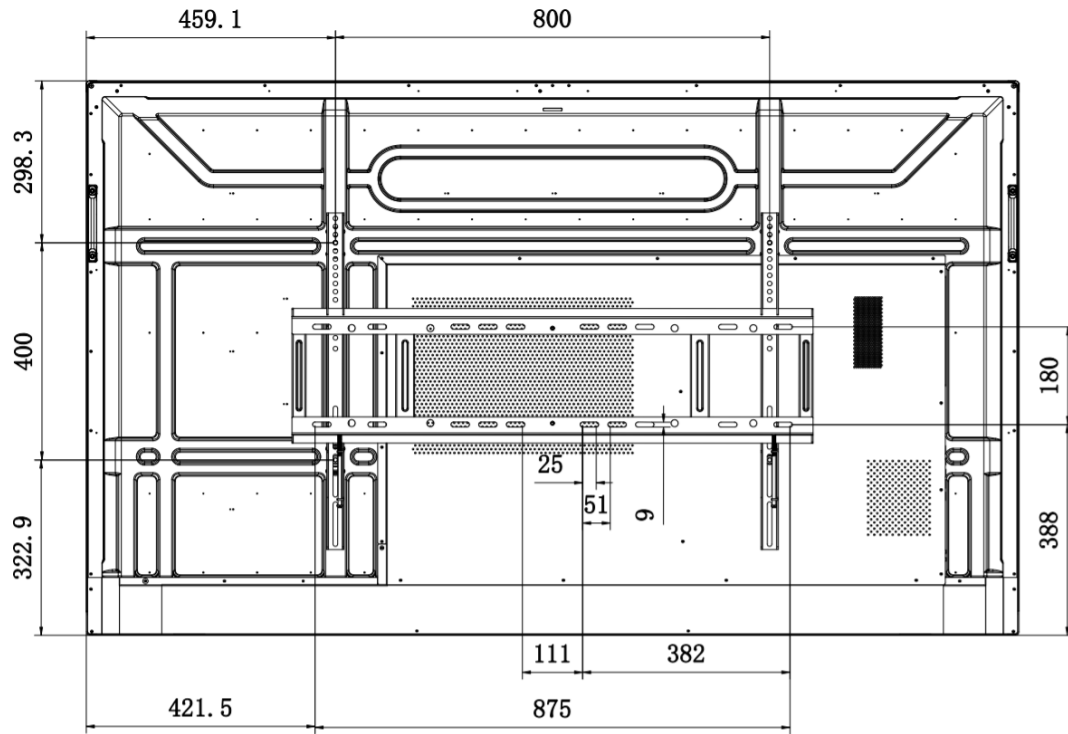

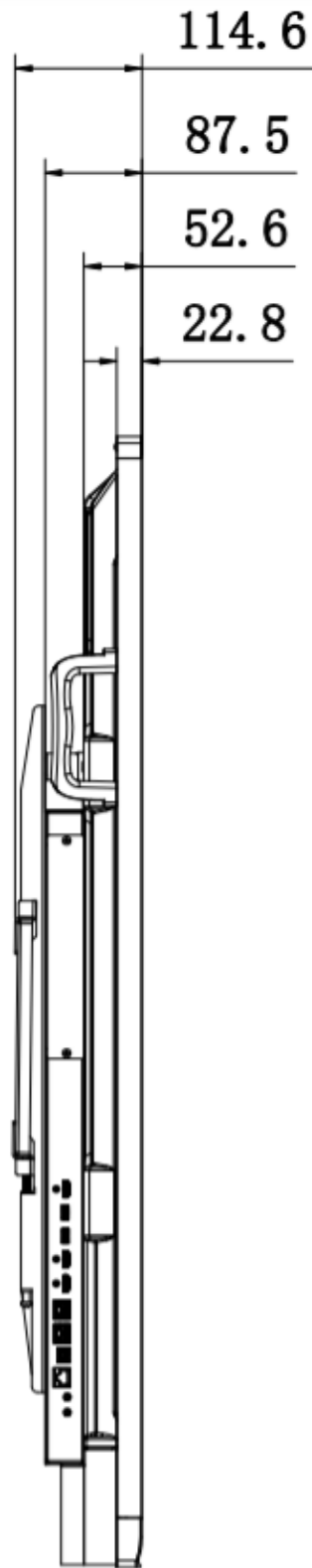

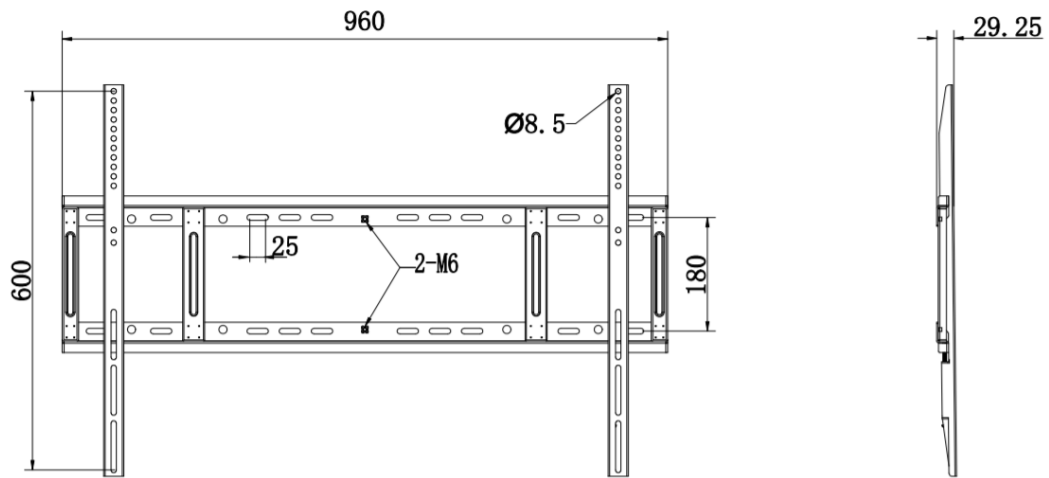

**Headquarters**

No.555 Qianmo Road, Binjiang District,  
Hangzhou 310051, China  
T +86-571-8807-5998  
www.hikvision.com



Follow us on social media to get the latest product and solution information.

