

# VP16-OLED

## Display User Guide



**IMPORTANT:** Please read this User Guide to obtain important information on installing and using your product in a safe manner, as well as registering your product for future service. Warranty information contained in this User Guide will describe your limited coverage from ViewSonic® Corporation, which is also found on our web site at <http://www.viewsonic.com> in English, or in specific languages using the Regional selection box in the upper right corner of our website.

Model No. VS19179  
P/N: VP16-OLED

## **Thank you for choosing ViewSonic®**

As a world-leading provider of visual solutions, ViewSonic® is dedicated to exceeding the world's expectations for technological evolution, innovation, and simplicity. At ViewSonic®, we believe that our products have the potential to make a positive impact in the world, and we are confident that the ViewSonic® product you have chosen will serve you well.

Once again, thank you for choosing ViewSonic®!

# Safety Precautions

Please read the following **Safety Precautions** before you start using the device.

- Keep this user guide in a safe place for later reference.
- Read all warnings and follow all instructions.
- Sit at least 18" (45 cm) away from the device.
- Allow at least 4" (10 cm) clearance around the device to ensure proper ventilation.
- Place the device in a well-ventilated area. Do not place anything on the device that prevents heat dissipation.
- Do not use the device near water. To reduce the risk of fire or electric shock, do not expose the device to moisture.
- Avoid exposing the device to direct sunlight or other sources of sustained heat.
- Do not install near any heat sources such as radiators, heat registers, stoves, or other devices (including amplifiers) that may increase the temperature of the device to dangerous levels.
- Use a soft, dry cloth to clean the external housing. For more information, refer to the "Maintenance" section of this manual.
- Avoid touching the screen, as oil may collect on the screen if you touch it.
- Do not touch the screen surface with sharp or hard objects, as it may cause damage to the screen.
- Do not place the device on cloth or other materials that may be placed between the product and supporting furniture.
- When moving the device, be careful not to drop or bump the device on anything.
- Do not place the device on an uneven or unstable surface. The device may fall over resulting in an injury or a malfunction.
- Do not place any heavy objects on the device or connection cables.
- Always use cabinets, stands, or installation methods recommended by the manufacturer of the device set.
- Always use furniture that can safely support the device.
- Always ensure the device is not overhanging the edge of the supporting furniture.
- Do not place the device on tall furniture, such as cupboards or bookcases, without anchoring both the furniture and the device to a suitable support.
- Always educate children about the dangers of climbing on furniture to reach the device or related equipment.

- Do not place the monitor where children are likely to be present.
- Do not place items that might tempt children to climb, such as toys and remote controls, on the top of the device or furniture on which the product is placed.
- If smoke, an abnormal noise, or a strange odor is present, immediately turn the device off and call your dealer or ViewSonic®. It is dangerous to continue using the device.
- Do not attempt to circumvent the safety provisions of the polarized or grounding-type plug. A polarized plug has two blades with one wider than the other. A grounding-type plug has two blades and a third grounding prong. The wide blade and the third prong are provided for your safety. If the plug does not fit into your outlet, obtain an adapter and do not attempt to force the plug into the outlet.
- When connecting to a power outlet, Do not remove the grounding prong. Please ensure grounding prongs are never removed.
- Always route and manage cords and cables connected to your device so they cannot be tripped over, pulled, or grabbed.
- Protect the power cord from being treaded upon or pinched, particularly at the plug, and at the point where it emerges from the equipment. Ensure that the power outlet is located near the equipment so that it is easily accessible.
- Disconnect the power plug from the power outlet if the device is not being used for a long period of time.
- Please confirm the distribution system installed in the building. The system should provide a circuit breaker rated at 120/240V, 20A.
- Only use attachments/accessories, such as carts, stands, tripods, brackets or tables, specified by the manufacturer.
- When a cart is used, use with caution when moving the cart/equipment combination to avoid injury from tipping over.
- Refer all servicing to qualified service personnel. Service will be required when the unit has been damaged in any way, such as:
  - » if the power-supply cord or plug is damaged.
  - » if liquid is spilled onto or objects fall into the unit.
  - » if the unit is exposed to rain or moisture.
  - » if the unit does not operate normally or has been dropped.
- When using ear-/headphones, adjust the volume to appropriate levels, or hearing damage may result.

- Fastening the display to a wall or fixed object using cordage or other restraining devices can help support the weight of the display in order to prevent the display from falling over.
- If the existing display is going to be retained and relocated, the same considerations as above should be applied.

**NOTE:** The OLED display is fragile. Please do not put pressure on the panel or frame.

# Contents

<b>Safety Precautions.....</b>	<b>3</b>
<b>Introduction .....</b>	<b>8</b>
Package Contents .....	8
Product Overview .....	9
<b>Initial Setup.....</b>	<b>10</b>
Installing the Cover.....	10
Using the Cover and Shade Hood .....	10
<b>Making Connections.....</b>	<b>11</b>
Connecting to Power .....	11
Connecting External Devices .....	12
Power Delivery .....	14
Powering a Notebook or Mobile Phone.....	14
Power Supply Detection.....	14
Power Delivery - Further Information .....	15
<b>Using the Monitor .....</b>	<b>16</b>
Adjusting the Viewing Angle.....	16
Tilt Angle Adjustment.....	16
Screen Orientation Adjustment (Monitor Pivot).....	18
Turning the Device On/Off .....	19
Using the Control Panel Keys.....	20
Startup Menu .....	20
Hot Keys .....	23
Configuring the Settings .....	25
General Operations .....	25
On-Screen Display (OSD) Menu Tree .....	27
Menu Options .....	34

<b>Appendix.....</b>	<b>40</b>
Specifications.....	40
Glossary .....	42
Troubleshooting .....	47
Maintenance.....	49
General Precautions.....	49
Cleaning the Screen.....	49
Cleaning the Case .....	49
<b>Regulatory and Service Information .....</b>	<b>50</b>
Compliance Information.....	50
FCC Compliance Statement.....	50
Industry Canada Statement.....	50
CE Conformity for European Countries.....	50
Declaration of RoHS2 Compliance.....	51
Indian Restriction of Hazardous Substances .....	52
Product Disposal at End of Product Life .....	52
Copyright Information .....	53
Customer Service .....	54
Limited Warranty .....	55
Mexico Limited Warranty.....	58

# Introduction

## Package Contents

- Monitor
- Power adapter
- USB Type C to Type A cable (1.5 m)
- Micro HDMI to HDMI cable (1.1 m)
- USB Type C to Type C cable (1.1 m)
- Quick start guide
- Monitor hood

**NOTE:** The power cord and video cables included in your package may vary depending on your country. Please contact your local reseller for more information.



# Product Overview

## Front View

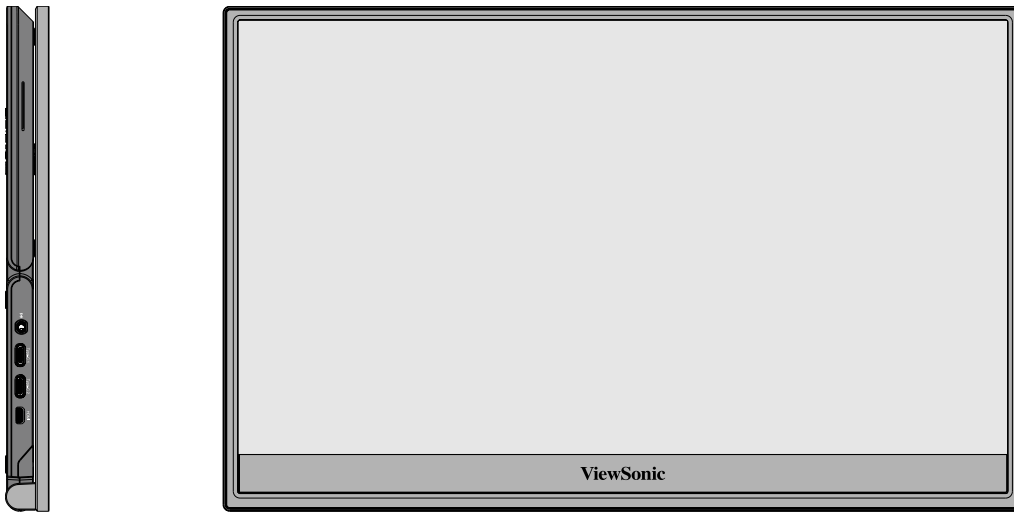

## Rear View

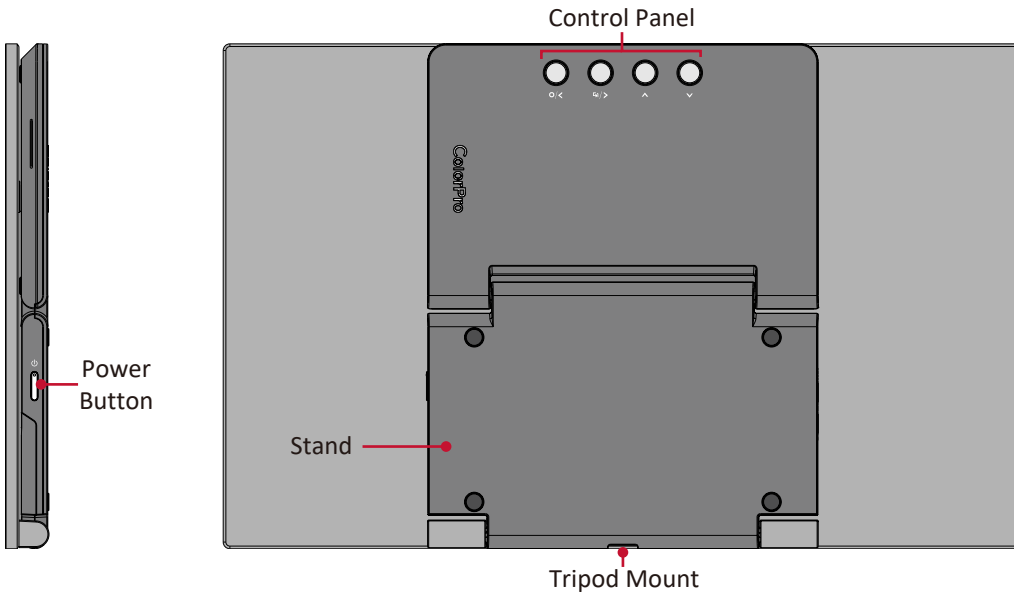

## I/O Ports

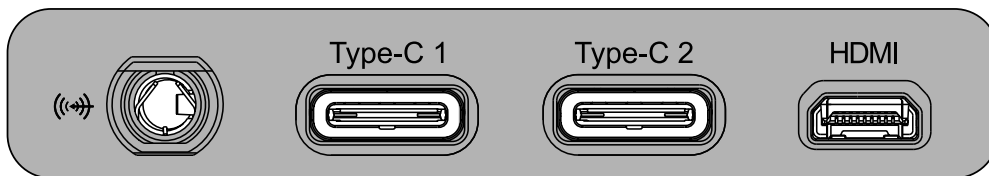

1

2

2

3

1. Audio Out

2. USB Type C

3. Micro HDMI

**NOTE:** For more information about the **Control Panel** keys and its functions, refer to “Hot Keys” on page 23.

# Initial Setup

## Installing the Cover

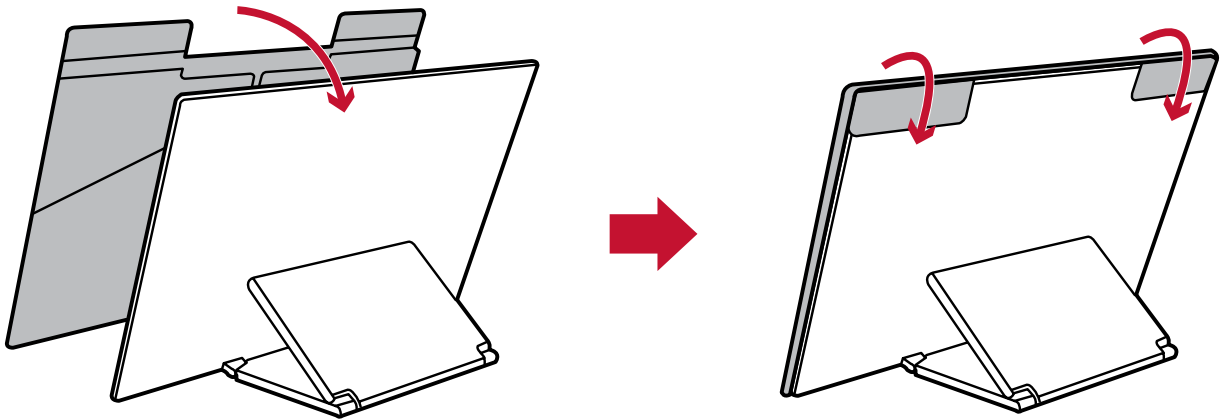

## Using the Cover and Shade Hood

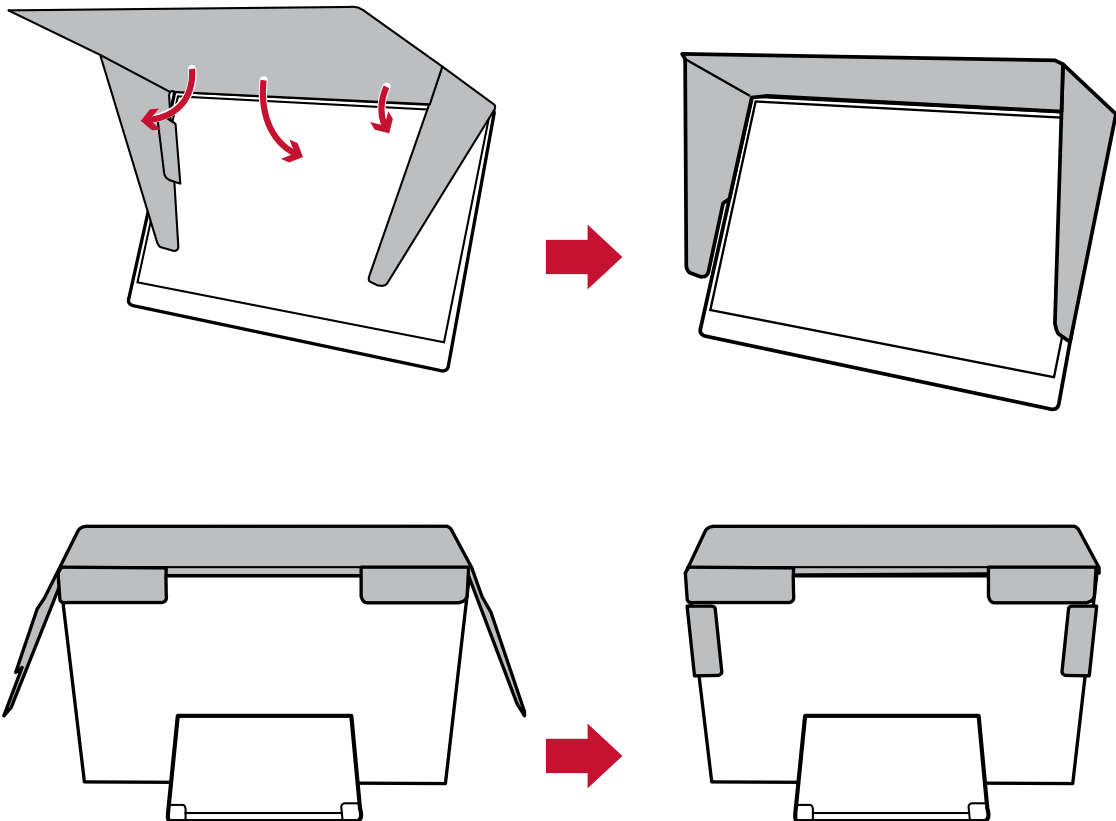

**NOTE:** Always place the device on a flat, stable surface. Failure to do so may cause the device to fall and damage the device and/or result in personal injury.

# Making Connections

## Connecting to Power

The monitor can be powered in any of the following configurations:

- **Type C Connection**

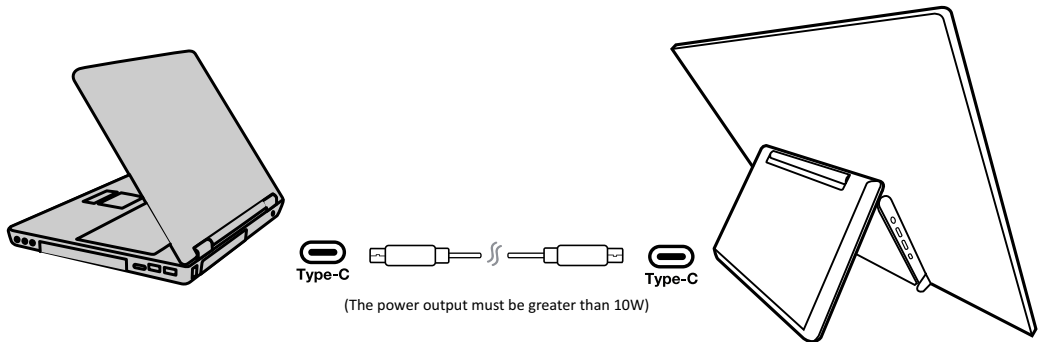

- **Type A Connection**

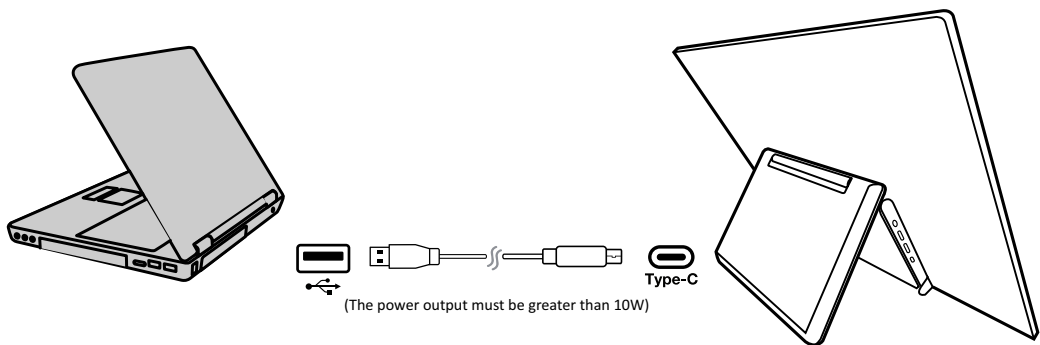

- **Power Adapter**

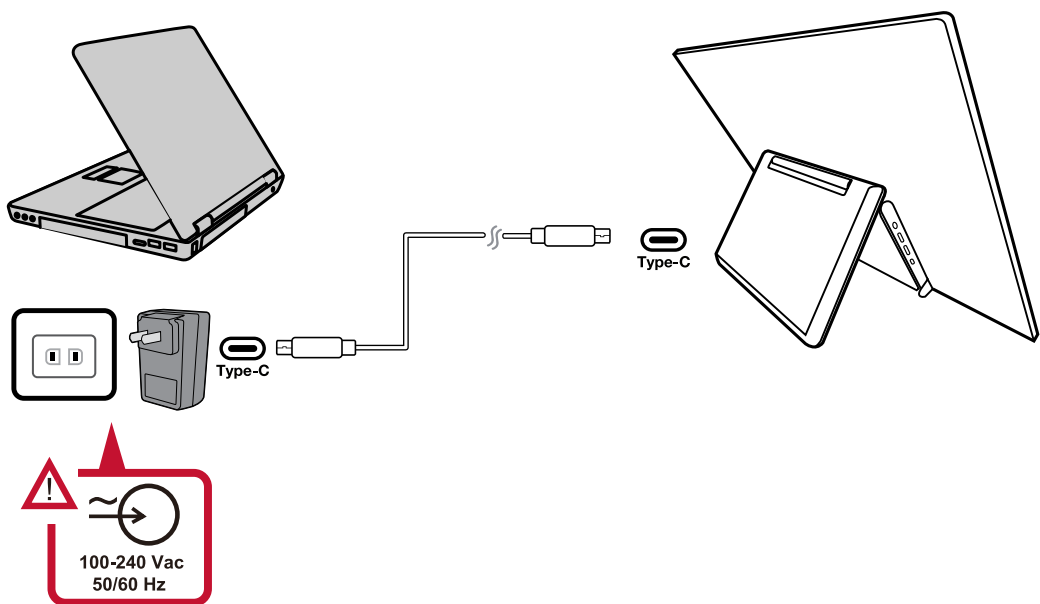

**NOTE:** For more information, please see “Power Delivery” on page 14.

# Connecting External Devices

Your external device(s) can be connected in any of the following configurations:

- **Type C Connection**

Connect a Type C cable from your external device to a **Type C** port on the monitor.

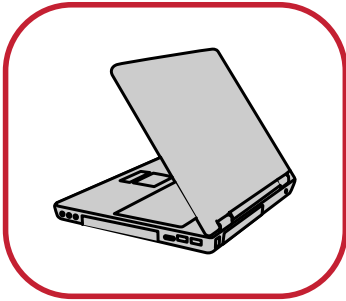

or

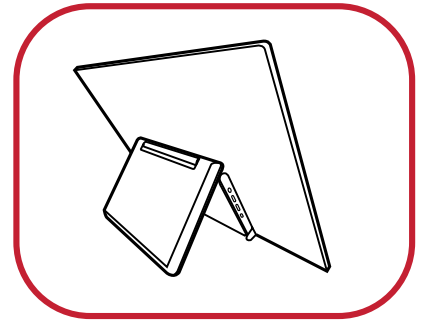
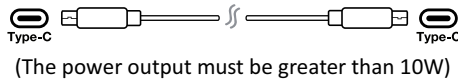
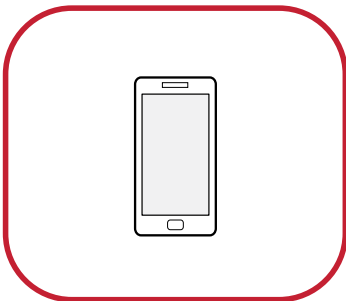

- **Micro HDMI Connection**

1. Connect the micro HDMI cable from your external device to the micro **HDMI** port on the monitor.
2. Connect the USB Type A to Type C cable from your external device.

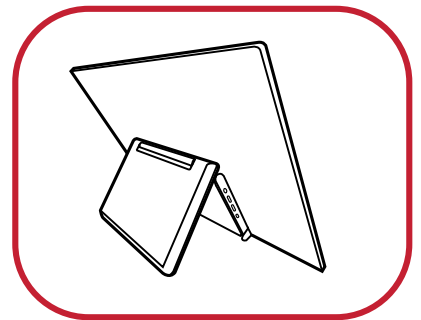
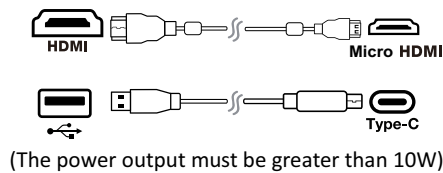

**NOTE:**

- The USB Type A to Type C connection will also supply power to the monitor from the notebook. The power output must be greater than 10W.

- **Audio Connection**

Plug the audio jack of the ear-/headphones into the **Audio Out** port of the monitor. Additionally, you can connect the monitor to a sound bar using an audio cable.

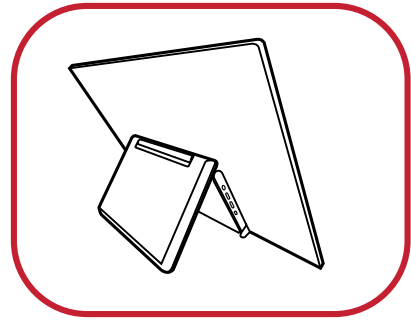

# Power Delivery

## Powering a Notebook or Mobile Phone

If the included power adapter is connected to the monitor, then the monitor can charge a connected notebook or mobile phone.

**NOTE:** Power Delivery Output: DC 9V/1.33A, 12V/1.75A, 15V/2A, 20V/2.0A.

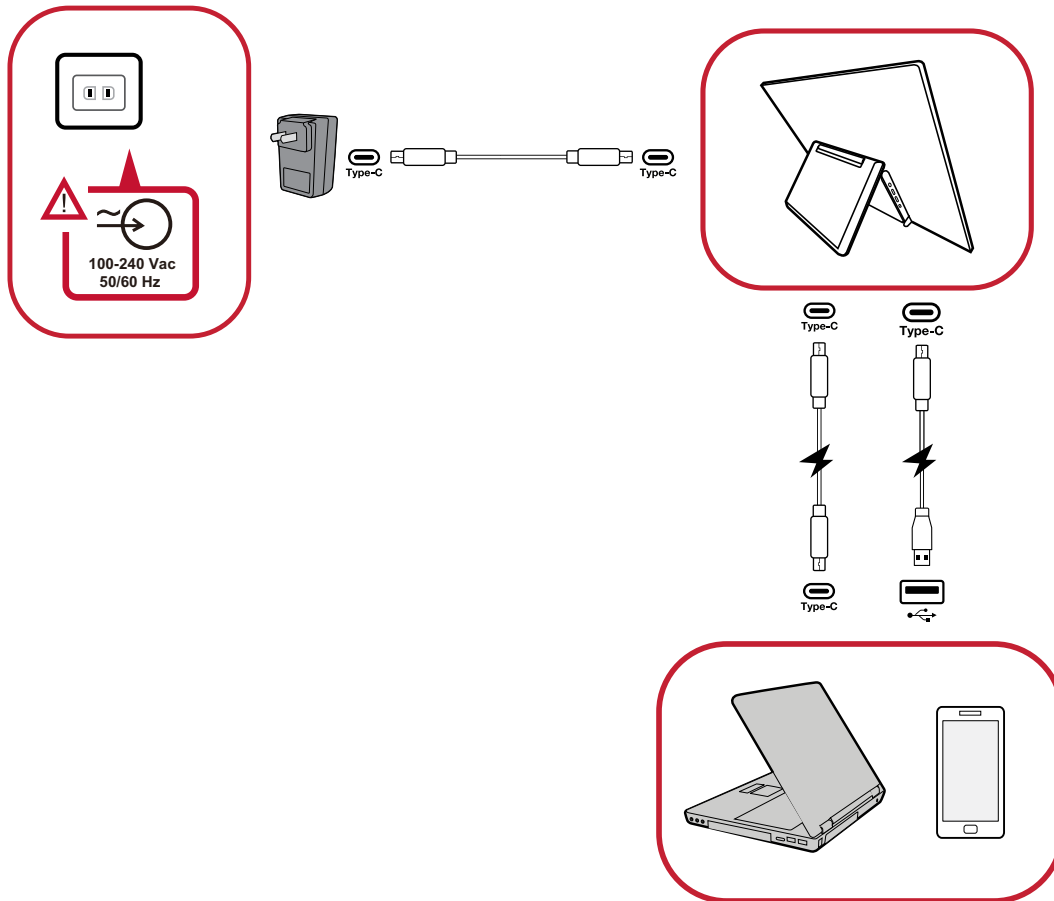

## Power Supply Detection

This product will detect if the power supply device is an adapter, laptop or mobile phone.

- If the power source is an adapter or notebook, the default brightness value will be 100.
- If the power source is a mobile phone, the default brightness value will be 15.
- When using a mobile phone to power the monitor, the default brightness level will be 15.

**NOTE:** Due to the limited power output of the mobile phone, do not adjust the brightness level higher as this may cause the display to flash or shut down.

## Power Delivery - Further Information

Due to the monitor's design please note:

- The first connected device will be the main input signal.
- When a Type C port recognizes an external device as a power adapter, it will only distribute the power. It will NOT display the input signal.
- Only when one of the Type C ports is recognized as a power adapter can the other one deliver two-way power.

If a laptop is connected first to the monitor, then a mobile phone is connected second, the mobile phone's battery will not be charged as neither Type C port recognizes the connection as being connected to a power adapter.

**NOTE:** If you want to display the mobile phone's screen, you must unplug the Type C cable connected to the laptop.

If a mobile phone is connected first to the monitor, then a laptop is connected second, the mobile phone's battery will be charged as one of the Type C ports is recognized as being connected to a power adapter.

**NOTE:** If you want to display the laptop screen, you must unplug the Type C cable connected to the mobile phone.

Due to the monitor's design, do not connect two laptops or one laptop and a desktop computer at the same time. This can cause power distribution conflicts, resulting in flashing screens or the forced shutdown of the laptop(s).

### **NOTE:**

- If the laptop has a Type C port, please connect via Type C to the monitor.
- Do not connect the other Type C port of the monitor to another laptop or desktop computer via Type A and HDMI at the same time.
- If the laptop only has HDMI and Type A ports, please connect via HDMI and Type A to Type C to the monitor.
- If the power output of the Type A port of the laptop is not greater than 10W, please use our power adapter to connect to the monitor.
- Do not connect the other Type C port of the monitor to another laptop or desktop computer at the same time.

# Using the Monitor

## Adjusting the Viewing Angle

### Tilt Angle Adjustment

The monitor has a double-hinged stand that allows for several viewing angles (20° to 60°).

- **Tilt Option 1**

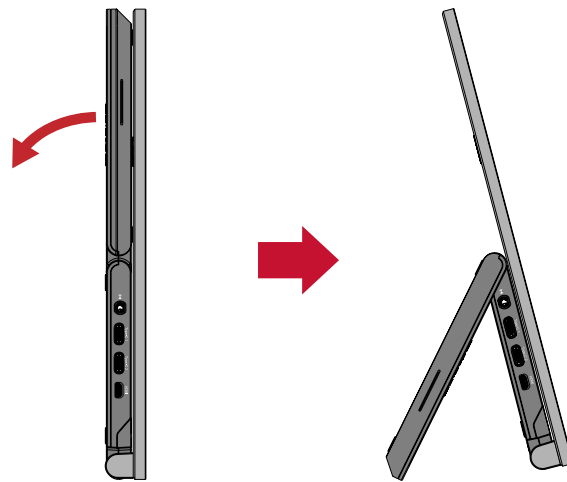

- **Tilt Option 2**

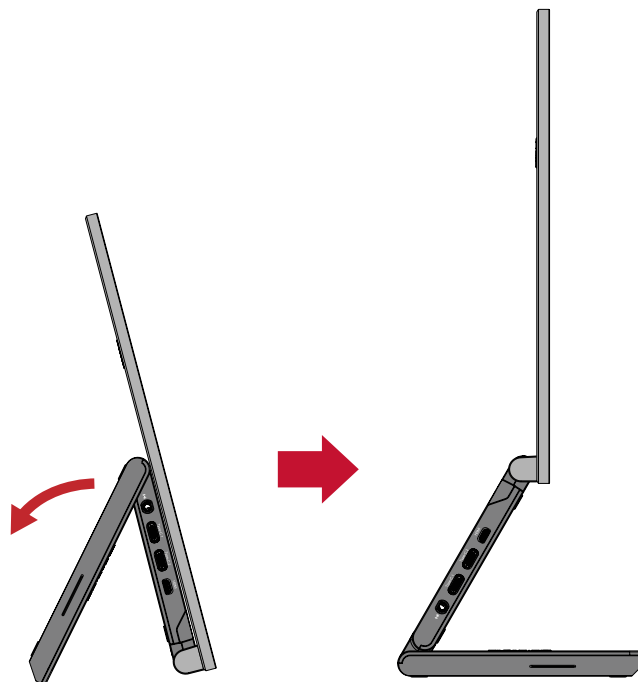



- **Tilt Option 3**



**NOTE:** When adjusting, support the monitor firmly with one hand while tilting the stand backwards with the other hand.

## Screen Orientation Adjustment (Monitor Pivot)

1. Extend the monitor's stand to the longest position.

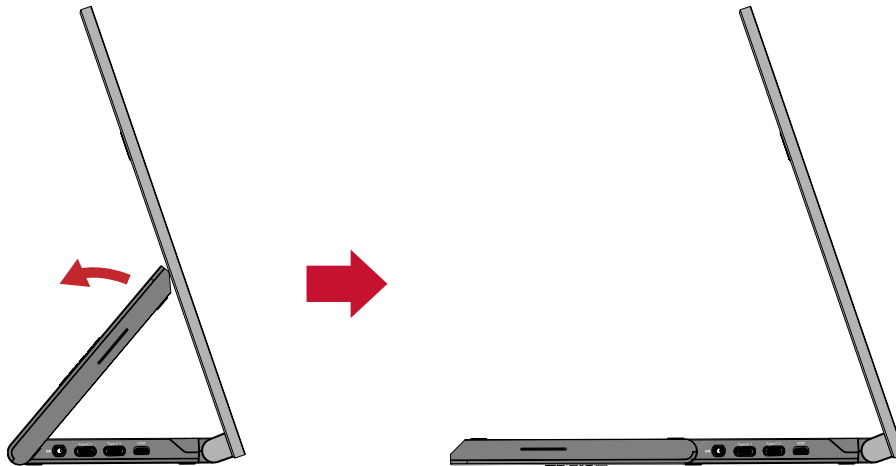

2. Rotate the monitor 90° clockwise or counter clockwise from landscape to portrait orientation.

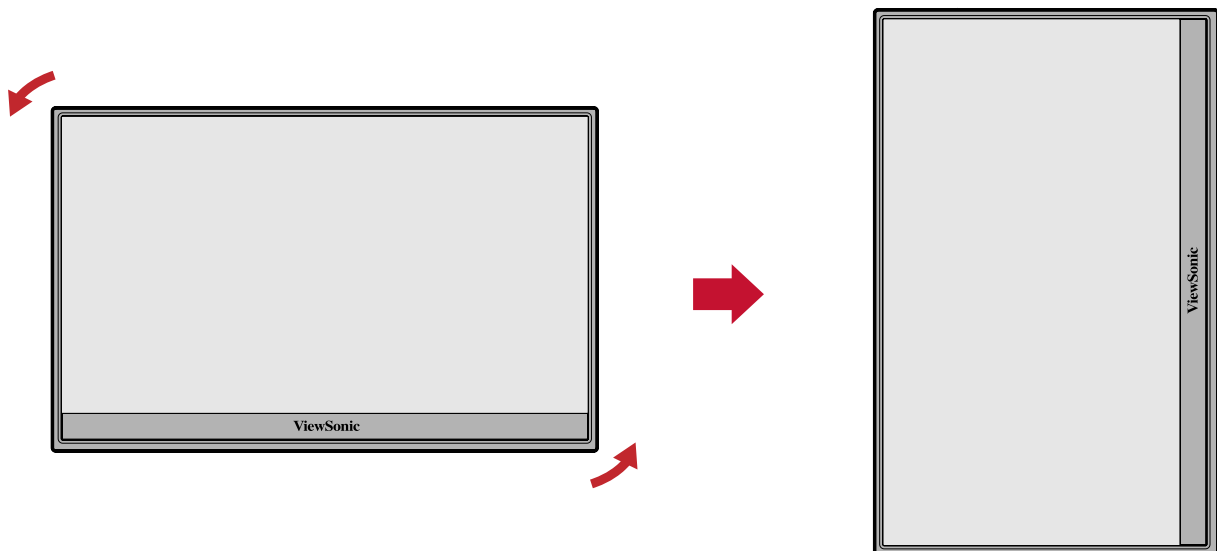

### NOTE:

- To rotate the screen image, manually change the system's display orientation settings.
- When adjusting, make sure to hold both sides of your monitor firmly with both hands.

## Turning the Device On/Off

1. Connect to a power source in one of the available configurations. For more information, see page 11.
2. Press the **Power Button** to turn on the monitor.
3. To turn the monitor off, press the **Power Button** again.

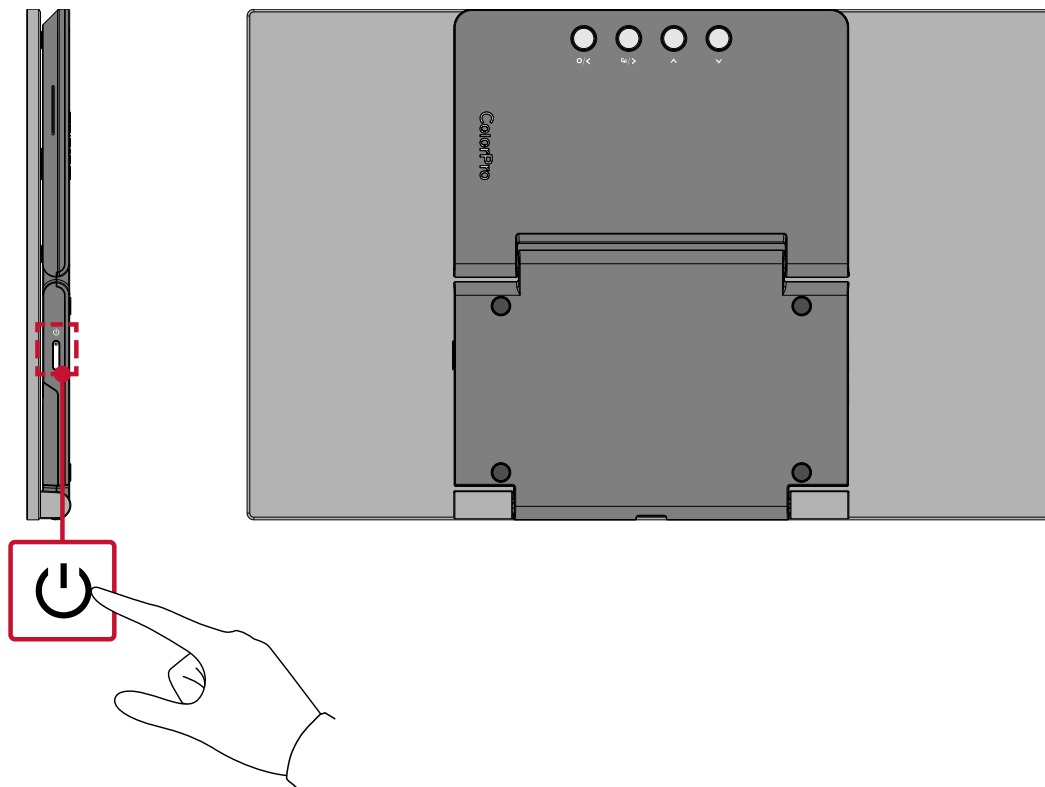

**NOTE:** The monitor will still consume some power as long as the power cord is connected to the power outlet. If the monitor is not being used for a long period of time, please disconnect from the power outlet.

# Using the Control Panel Keys

Use the Control Panel keys to access the Startup Menu, activate Hot Keys, navigate the On-Screen Display (OSD) Menu, and change the settings.

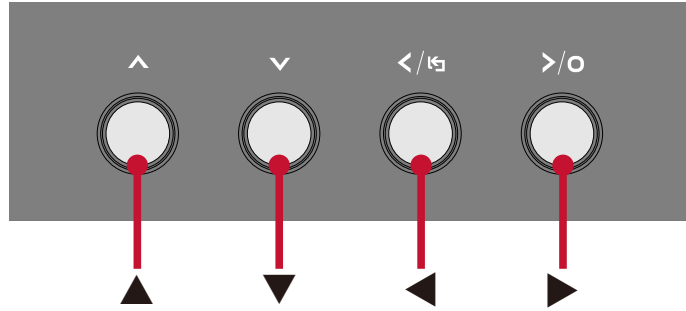

## Startup Menu

Press the ▲/▼/▶ key to activate the Startup Menu.

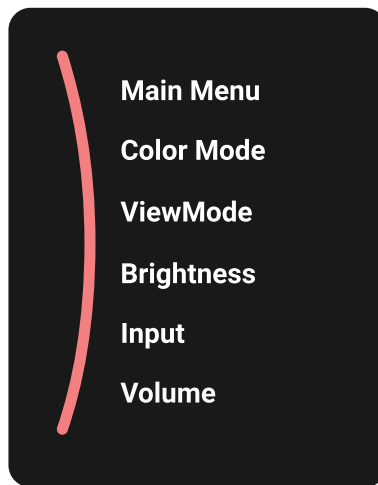

**NOTE:** Follow the key guide that appears on the screen to select the option or make adjustments.

## Main Menu

Enter the On-Screen Display (OSD) Menu.

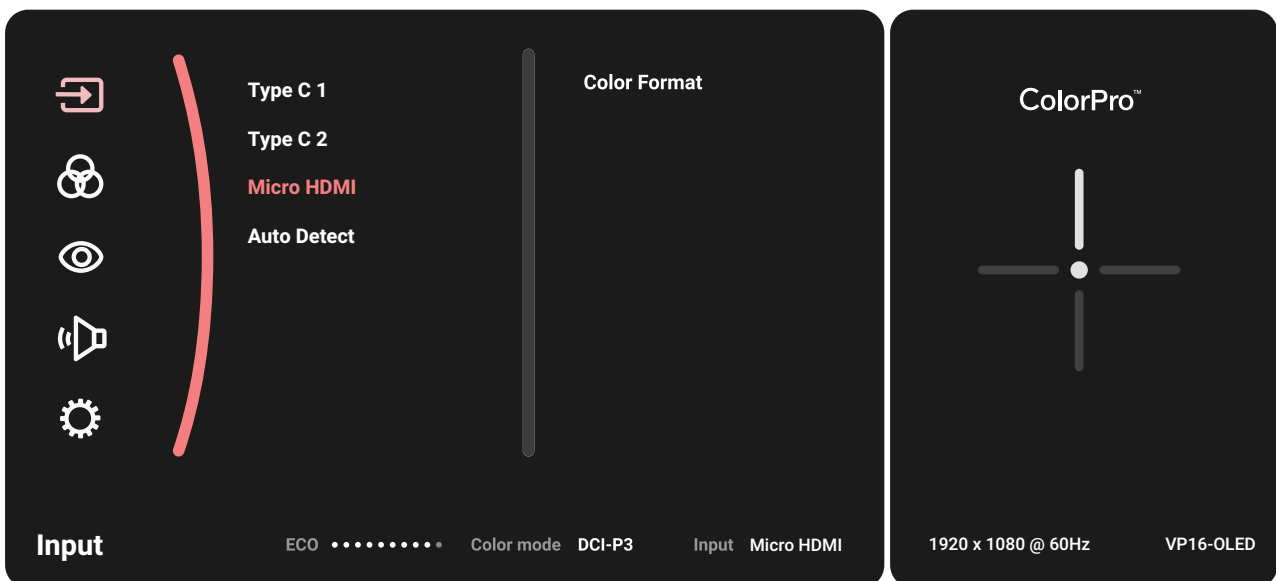

## Color Mode

Select one of the preset standard color settings.

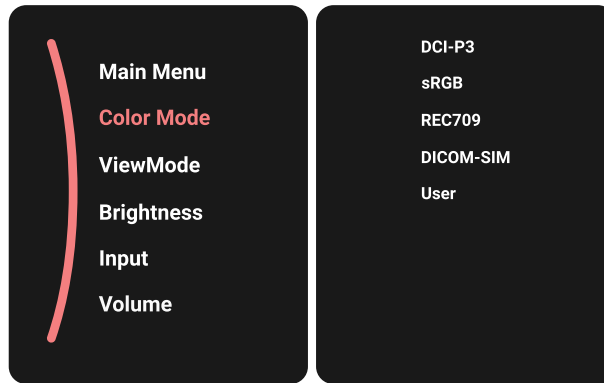

## ViewMode

Select one of the preset display settings.

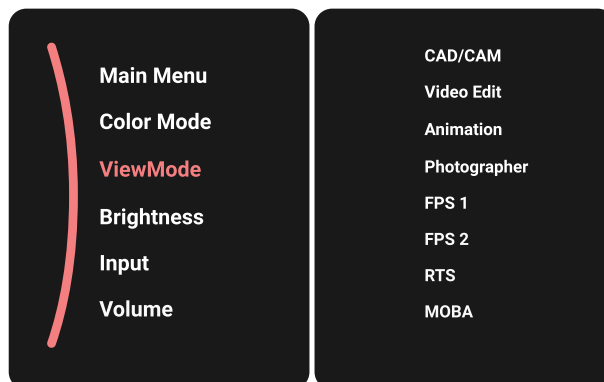

## Brightness

Adjust the brightness level.

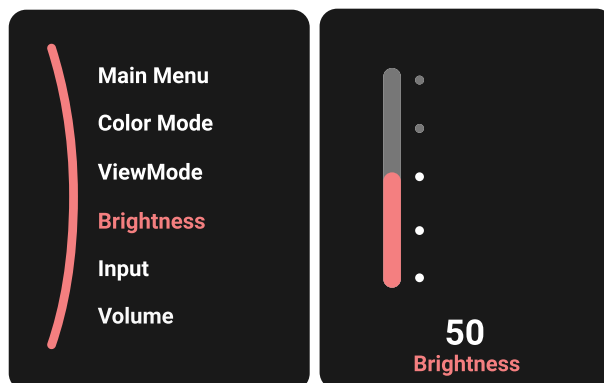

## Input

Select the input source.

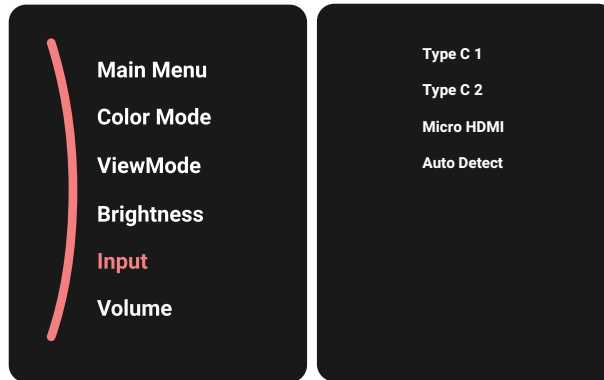

## Volume

Adjust the volume settings.

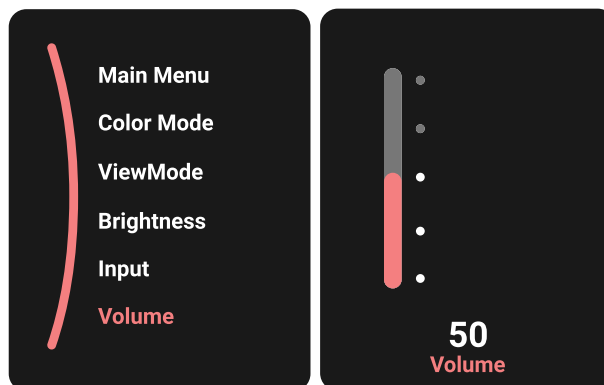

**NOTE:** Press the ◀ Key to return to the previous menu.

## Hot Keys

When the On-Screen Display (OSD) Menu is off, you can quickly access special functions by using the control panel keys.

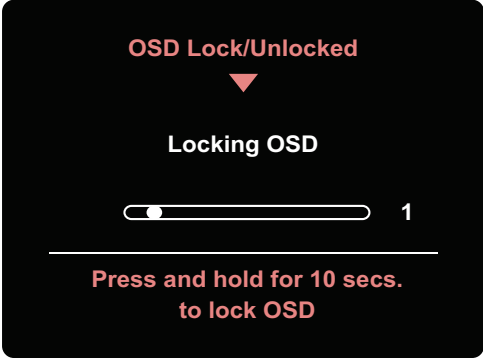
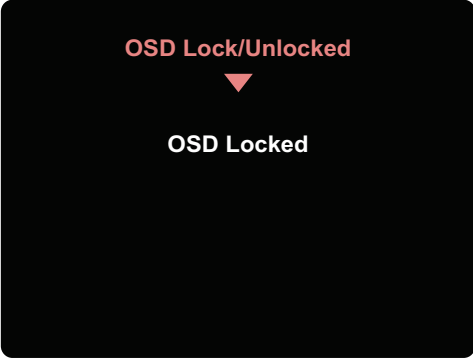
Key	Description
▲ + ◀	<p>Press and hold the keys to lock/unlock the OSD Menu.</p> <p>When the menu appears on the screen, continue holding the keys for 10 seconds to lock/unlock the OSD Menu.</p>  <p>If the OSD Menu is locked, the below message will appear on the screen:</p> 

Key	Description
▼ + ◀	<p>Press and hold the keys to lock/unlock the <b>Power</b> button.</p> <p>When the menu appears on the screen, continue holding the keys for 10 seconds to lock/unlock the <b>Power</b> button.</p> <div data-bbox="655 342 1141 694" data-label="Image"> <p>A screenshot of a black menu titled "Power Lock/Unlocked" with a downward arrow. Below the arrow, it says "Locking Power Button". There is a progress bar with a white dot at the beginning and the number "1" at the end. Below the progress bar, it says "Press and hold for 10 secs. to lock Power".</p> </div> <p>If the <b>Power</b> button is locked, the below message will appear on the screen:</p> <div data-bbox="655 826 1141 1178" data-label="Image"> <p>A screenshot of a black menu titled "Power Lock/Unlocked" with a downward arrow. Below the arrow, it says "Power Button Locked".</p> </div>
▼ + ▶	<p>Press to display/hide the boot up screen when the device is turned on.</p> <div data-bbox="665 1299 1133 1637" data-label="Image"> <p>A screenshot of a black menu titled "Boot Up Screen On/Off" with a downward arrow. Below the arrow, it says "Off". At the bottom, there is a horizontal line and the text "Press to turn On".</p> </div>



# Configuring the Settings

## General Operations

1. Press the ▲/▼/▶ key to display the Startup Menu. Then navigate to **Main Menu** and press the ▶ key to display the OSD Menu.

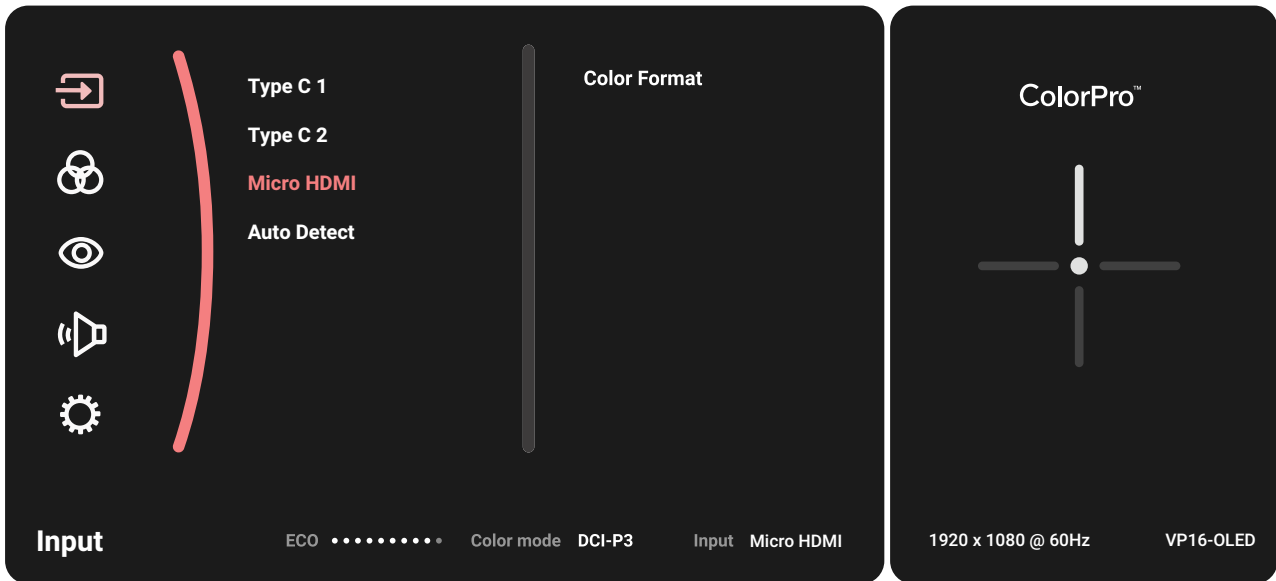

2. Press the ▲ or ▼ key to select the main menu. Then press the ▶ key to enter the selected menu.

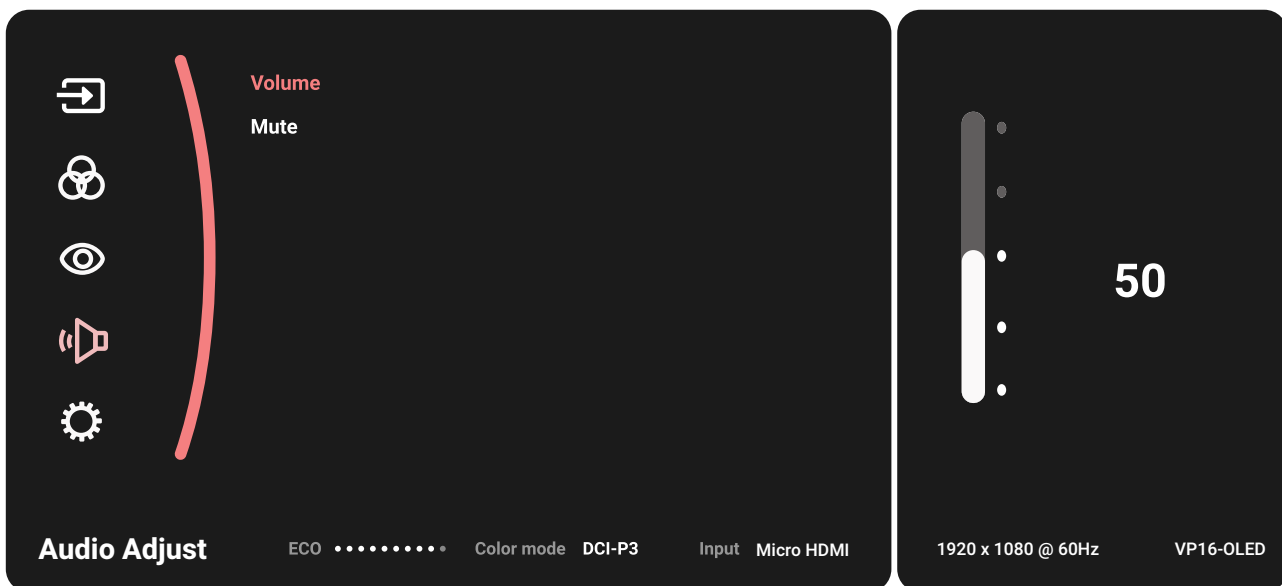

3. Press the ▲ or ▼ key to select the desired menu option. Then press the ► key to enter the sub-menu.



4. Press the ▲ or ▼ key to adjust/select the setting. Then press the ► key to confirm.

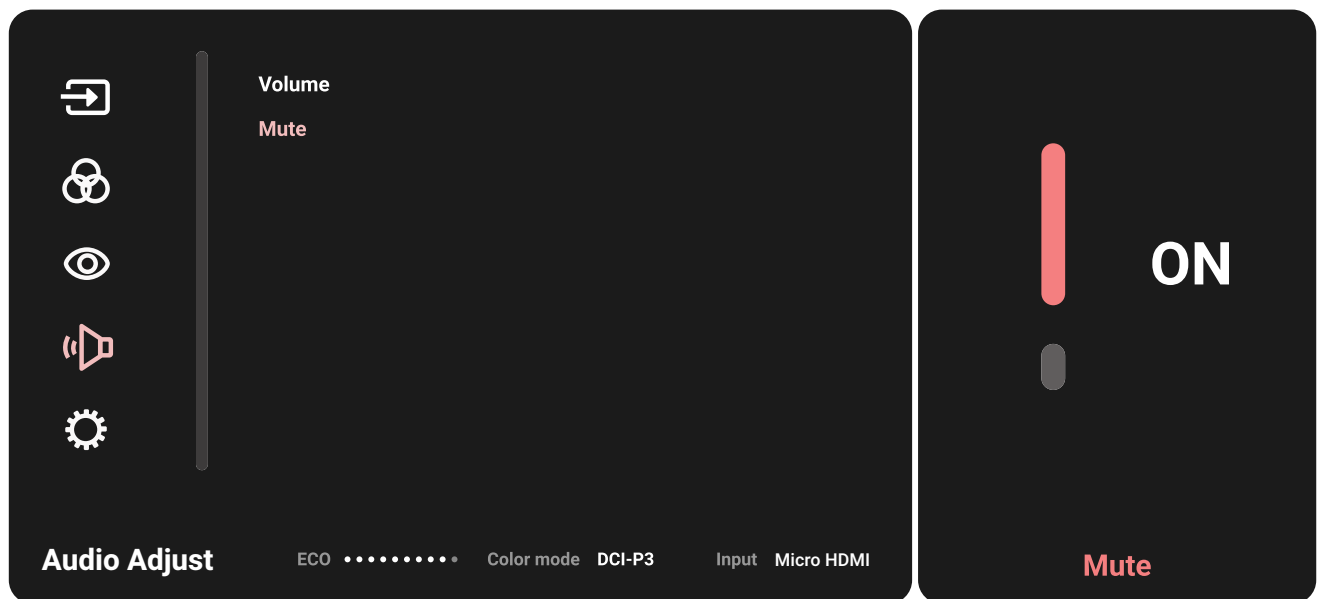

5. Press the ◀ key to return to the previous menu.

## On-Screen Display (OSD) Menu Tree

Main Menu	Sub-menu	Menu Option	
Input Select	Type C 1	Color Format	Auto
			RGB (Full Range)
			RGB (Limited Range)
			YUV (Full Range)
			YUV (Limited Range)
	Type C 2	Color Format	Auto
			RGB (Full Range)
			RGB (Limited Range)
			YUV (Full Range)
			YUV (Limited Range)
	Micro HDMI	Color Format	Auto
			RGB (Full Range)
			RGB (Limited Range)
			YUV (Full Range)
			YUV (Limited Range)
	Auto Detect	On	
Off			
Color Mode	DCI-P3	Brightness	(-/+ , 0~100)
		Color Temperature	Panel Default
			D93
			D75
			D65
			D63
			D50
		Gamma	DCI-P3
			1
			1.4
			1.8
			2.0
			2.2
			2.4
			2.6
		Sharpness	(-/+ , 0/25/50/70/100)
Aspect Ratio	1:1		
	4:3		
	Full Screen		
Recall			

Main Menu	Sub-menu	Menu Option	
Color Mode	sRGB	Brightness	(-/+ , 0~100)
		Color Temperature	Panel Default
			D93
			D75
			D65
			D63
			D50
		Gamma	sRGB
			1
			1.4
			1.8
			2.0
			2.2
			2.4
			2.6
		Sharpness	(-/+ , 0/25/50/70/100)
		Aspect Ratio	1:1
4:3			
Full Screen			
Recall			

Main Menu	Sub-menu	Menu Option	
Color Mode	REC709	Brightness	(-/+ , 0~100)
		Color Temperature	Panel Default
			D93
			D75
			D65
			D63
			D50
		Gamma	REC709
			1
			1.4
			1.8
			2.0
			2.2
			2.4
	2.6		
	Sharpness	(-/+ , 0/25/50/70/100)	
	Aspect Ratio	1:1	
		4:3	
		Full Screen	
	Recall		
DICOM-SIM	Sharpness	(-/+ , 0/25/50/70/100)	
	Aspect Ratio	1:1	
		4:3	
		Full Screen	
	Recall		

Main Menu	Sub-menu	Menu Option		
Color Mode	User	Contrast	(-/+ , 0~100)	
		Brightness	(-/+ , 0~100)	
		Color Temperature	Panel Default	
			D93	
			D75	
			D65	
			D63	
			D50	
		Gamma	Panel Default	
			1	
			1.4	
			1.8	
			2.0	
			2.2	
			2.4	
			2.6	
		Advanced DCR	(-/+ , 0/25/50/75/100)	
		Gain	Red	(-/+ , 0~100)
			Green	(-/+ , 0~100)
			Blue	(-/+ , 0~100)
		Offset	Red	(-/+ , 0~100)
			Green	(-/+ , 0~100)
			Blue	(-/+ , 0~100)
		Hue	Red	(-/+ , 0~100)
			Green	(-/+ , 0~100)
			Blue	(-/+ , 0~100)
			Cyan	(-/+ , 0~100)
			Magenta	(-/+ , 0~100)
			Yellow	(-/+ , 0~100)
		Saturation	Red	(-/+ , 0~100)
Green	(-/+ , 0~100)			
Blue	(-/+ , 0~100)			
Cyan	(-/+ , 0~100)			
Magenta	(-/+ , 0~100)			
Yellow	(-/+ , 0~100)			

Main Menu	Sub-menu	Menu Option		
<b>Color Mode</b>	User	Sharpness	(-/+ , 0/25/50/75/100)	
		Aspect Ratio	1:1	
			4:3	
			Full Screen	
		Blue Light Filter	(-/+ , 0~5)	
Recall				
<b>ViewMode</b>	CAD/CAM	Ultra Clear	(-/+ , 0~100)	
		Advanced-Sharpness	(-/+ , 0/25/50/75/100)	
		Advanced-Gamma	Panel Default (-/+ , 1~2.6)	
	Video Edit	Ultra Clear	(-/+ , 0~100)	
		Advanced-Sharpness	(-/+ , 0/25/50/75/100)	
		Advanced-Gamma	Panel Default (-/+ , 1~2.6)	
	Animation	Ultra Clear	(-/+ , 0~100)	
		Advanced-Sharpness	(-/+ , 0/25/50/75/100)	
		Black Stabilization	(-/+ , 0~100)	
	Photographer	Ultra Clear	(-/+ , 0~100)	
		Advanced-Sharpness	(-/+ , 0/25/50/75/100)	
		Advanced-Gamma	Panel Default (-/+ , 1~2.6)	
	FPS 1			
	FPS 2			
	RTS			
	MOBA			
	<b>Audio Adjust</b>	Volume	(-/+ , 0~100)	
		Mute	On	
			Off	

Main Menu	Sub-menu	Menu Option
Setup Menu	Language Select	English
		Français
		Deutsch
		Español
		Italiano
		Suomi
		Русский
		Türkçe
		日本語
		한국어
		繁體中文
		简体中文
		Česká
		Svenska
	Resolution Notice	On
		Off
	Information	
	OSD Timeout	(-/+ , 5/15/30/60)
	OSD Background	On
		Off
	OSD Pivot	Auto
		0°
		+90°
		-90°
	Power Indicator	180°
		On
	Auto Power Off	Off
On		
Sleep	Off	
	30 minutes	
	45 minutes	
	60 minutes	
	120 minutes	



Main Menu	Sub-menu	Menu Option		
Setup Menu	ECO Mode	Standard		
		Optimize		
		Conserve		
		Energy Saving		On
			Off	
	Overscan	On		
		Off		
	Burn-in Eraser	On		
		Off		
	DDC/CI	On		
		Off		
	Rename			
	All Recall			

## Menu Options

### Input

1. Press the ▲/▼/▶ key to display the Startup Menu. Then navigate to **Main Menu** and press the ▶ key to display the OSD Menu.
2. Press the ▲ or ▼ key to select **Input**. Then press the ▶ key to enter the **Input** menu.

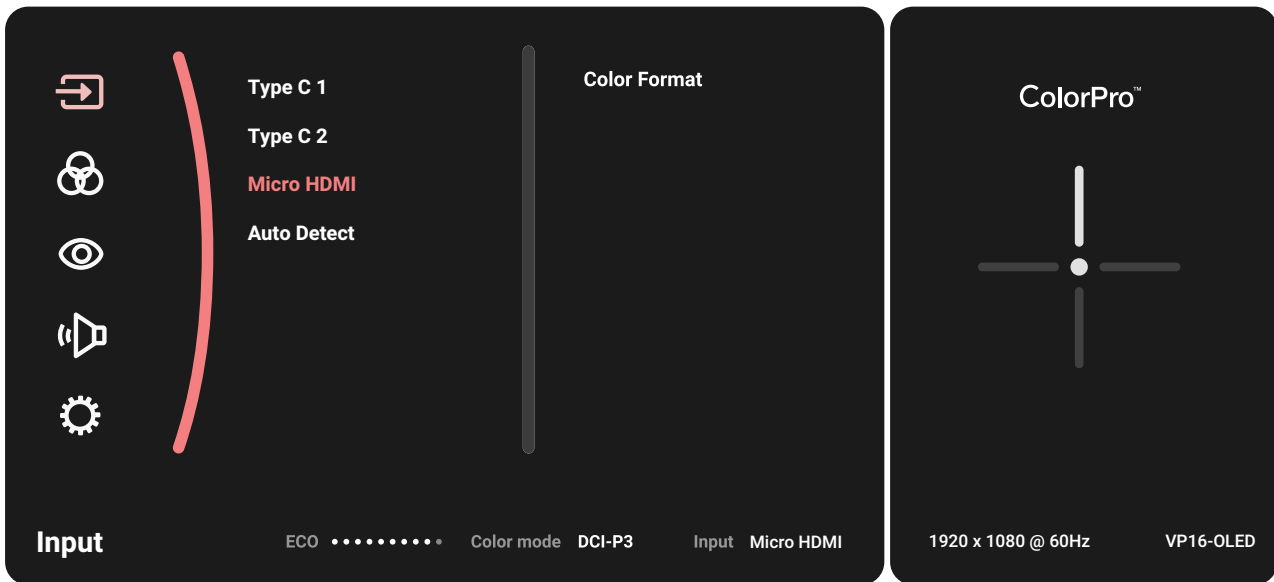

3. Press the ▲ or ▼ key to select the desired input source. Then press the ▶ key to confirm the selection.

## Color Mode

1. Press the ▲/▼/▶ key to display the Startup Menu. Then navigate to **Main Menu** and press the ▶ key to display the OSD Menu.
2. Press the ▲ or ▼ key to select **Color Mode**. Then press the ▶ key to enter the **Color Mode** menu.

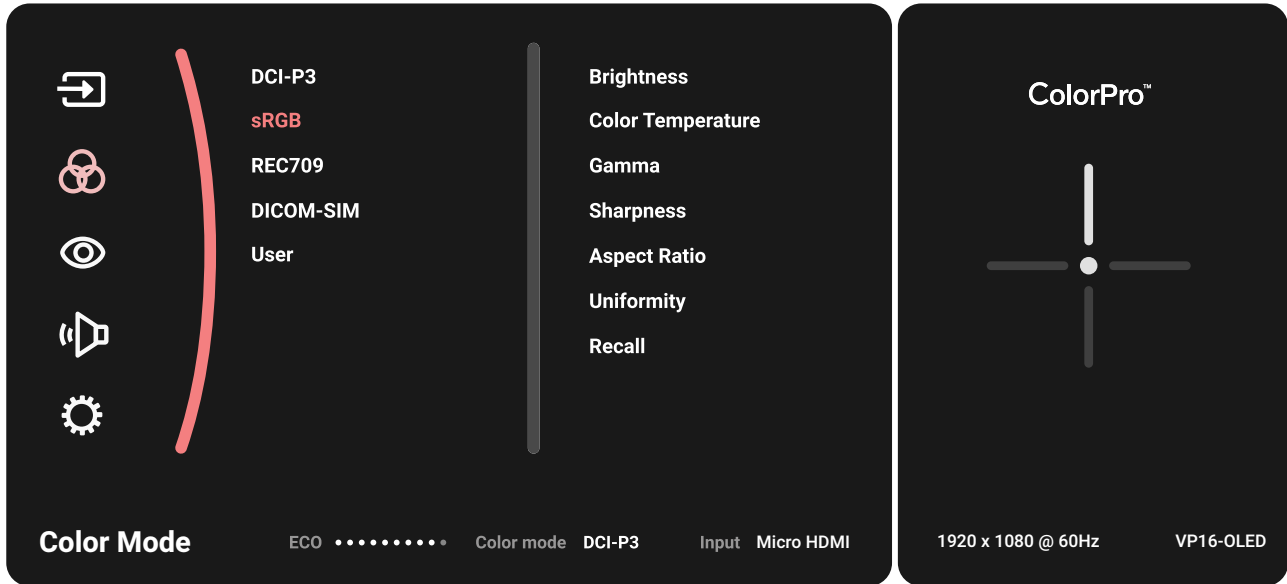

3. Press the ▲ or ▼ key to select the desired option. Then press the ▶ key to enter its sub-menu.
4. Press the ▲ or ▼ key to adjust/select the setting, and press the ▶ key to confirm the selection (if applicable).

Menu Option	Description
DCI-P3	Precise color gamut and gamma of DCI-P3 standard.
sRGB	Precise color gamut and gamma of sRGB standard.
REC709	Precise color gamut and gamma of ITU-R Rec. 709 standard.
DICOM-SIM	Gamma curves are set to a DICOM simulation.
User	Custom, user-defined settings.

## ViewMode

1. Press the ▲/▼/▶ key to display the Startup Menu. Then navigate to **Main Menu** and press the ▶ key to display the OSD Menu.
2. Press the ▲ or ▼ key to select **ViewMode**. Then press the ▶ key to enter the **ViewMode** menu.

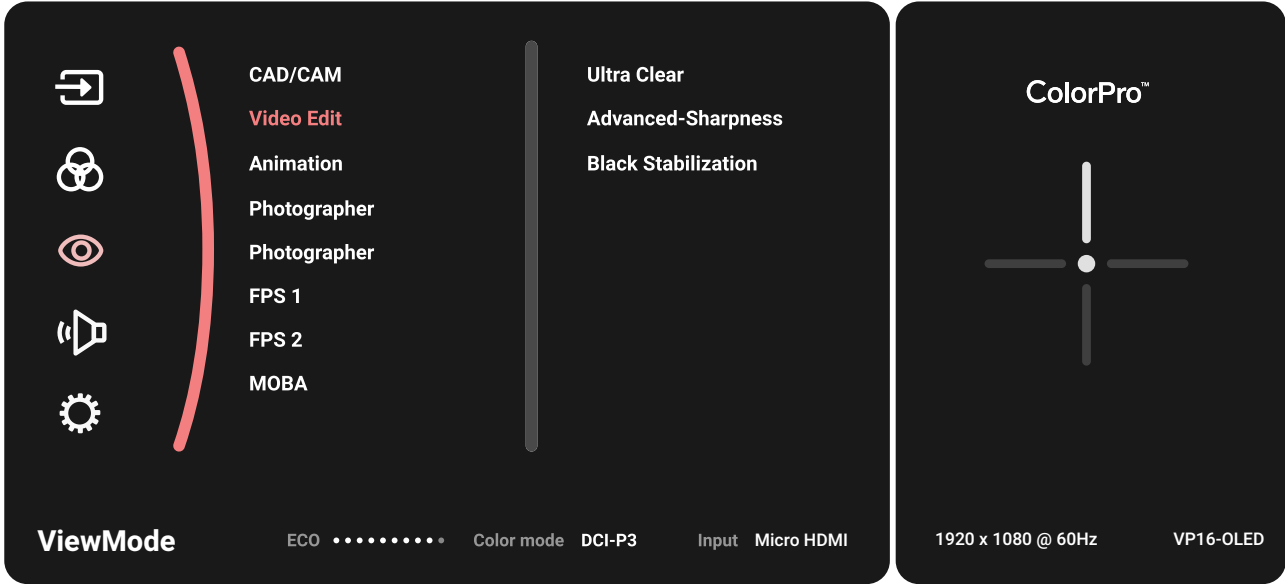

3. Press the ▲ or ▼ key to select the desired option. Then press the ▶ key to enter its sub-menu.

Menu Option	Description
CAD/CAM	Select this option for viewing graphic design files.
Video Edit	Select this option for video editing.
Animation	Select this option for animation.
Photographer	Select this option for viewing photo files.
FPS 1	Ideal for First-Person Shooter games.
FPS 2	Ideal for First-Person Shooter games.
RTS	Ideal for Real-Time Strategy games.
MOBA	Select this option for Multiplayer Online Battle Arena games.

## Audio Adjust

1. Press the ▲/▼/▶ key to display the Startup Menu. Then navigate to **Main Menu** and press the ▶ key to display the OSD Menu.
2. Press the ▲ or ▼ key to select **Audio Adjust**. Then press the ▶ key to enter the **Audio Adjust** menu.

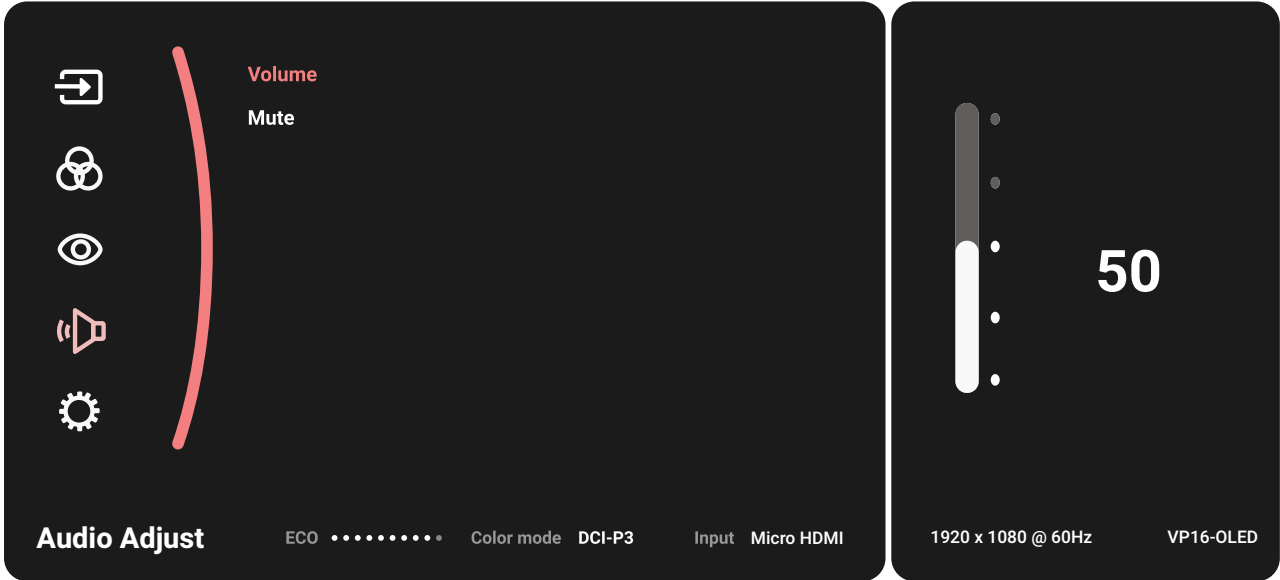

3. Press the ▲ or ▼ key to select the desired option. Then press the ▶ key to enter its sub-menu.
4. Press the ▲ or ▼ key to adjust/select the setting, and press the ▶ key to confirm the selection (if applicable).

Menu Option	Description
Volume	Adjust the volume level.
Mute	Enable this option to temporarily turn off the sound.

## Setup Menu

1. Press the ▲/▼/▶ key to display the Startup Menu. Then navigate to **Main Menu** and press the ▶ key to display the OSD Menu.
2. Press the ▲ or ▼ key to select **Setup Menu**. Then press the ▶ key to enter the **Setup Menu** menu.

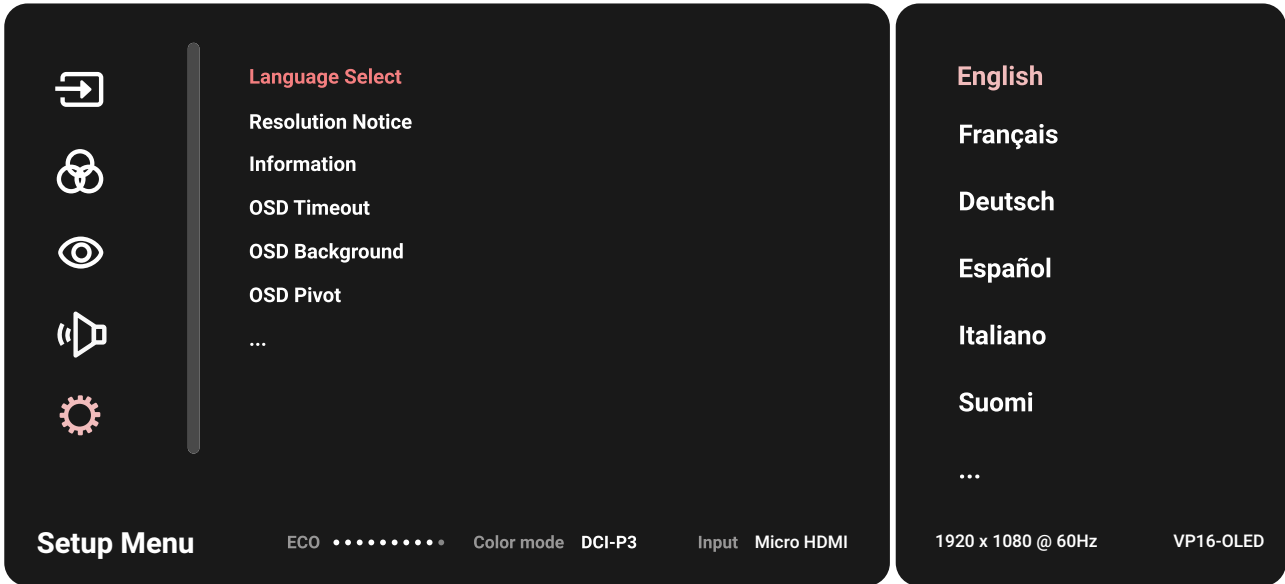

3. Press the ▲ or ▼ key to select the desired option. Then press the ▶ key to enter its sub-menu.
4. Press the ▲ or ▼ key to adjust/select the setting, and press the ▶ key to confirm the selection (if applicable).

**NOTE:** Some sub-menu options may have another sub-menu. To enter the respective sub-menu, press the ▶ key. Follow the key guide that appears on the bottom of the screen to select the option or make adjustments.

Menu Option	Description
Language Select	Select an available language for the OSD Menu.
Resolution Notice	Enable this option to allow the system to inform users that the current viewing resolution is not the correct native resolution.
Information	Display the monitor information.
OSD Timeout	Set the length of time the OSD Menu remains on screen.
OSD Background	Show/Hide the OSD background when the OSD Menu appears on the screen.

Menu Option	Description
OSD Pivot	Set the OSD Menu orientation. <ul style="list-style-type: none"> <li>• Auto: With the built-in G sensor, the OSD Menu can automatically pivot when the monitor is positioned vertically.</li> <li>• 0°: Sets the OSD Menu without a pivot.</li> <li>• +90°: Sets the OSD Menu with a +90° pivot.</li> <li>• -90°: Sets the OSD Menu with a -90° pivot.</li> <li>• 180°: Sets the OSD Menu with a 180° pivot.</li> </ul>
Power Indicator	Set the Power Indicator On or Off. If the setting is set to On, the power indicator lights blue when the device is turned on.
Auto Power Off	Enable this option to allow the monitor to automatically turn off after a certain amount of time.
Sleep	Set the amount of idle time before the monitor enters <i>Sleep mode</i> .
ECO Mode	Choose between various modes, based on power consumption.
Overscan	Enable this option to automatically enlarge the original picture horizontally and vertically to an equal aspect ratio that fills the screen.
Burn-in Eraser	Reduce image burn-in.
Rename	Rename the personalized custom profile.
All Recall	Resets all settings to their default values.

# Appendix

## Specifications

Item	Category	Specifications
LCD	Type	LTPS TFT Active Matrix Full HD 1920 x 1080, 0.17928 mm x 0.17928 mm pixel pitch, Sub-Pixel: 59.76 x 179.28 (um)
	Display Size	39.6 cm, 15.6" diagonal
	Color Filter	RGB Stripe Type
	Glass Surface	Anti-Glare (Haze 25%), Hard Coating (3H)
Input Signal	Video Sync	<u>TMDS digital (100 Ω)</u> HDMI (v. 1.4): $f_h$ :24-83 kHz, $f_v$ :50-61 Hz <u>Micro-Packet</u> Type C: $f_h$ :24-83 kHz, $f_v$ :50-61 Hz
Compatibility	PC	up to 1920 x 1080
	Macintosh	up to 1920 x 1080
Resolution <sup>1</sup>	Recommended	1920 x 1080 @ 60Hz
	Supported	<ul style="list-style-type: none"> <li>• 1920 x 1080 @ 50, 60Hz</li> <li>• 1680 x 1050 @ 60Hz</li> <li>• 1600 x 1200 @ 60Hz</li> <li>• 1600 x 900 @ 60Hz</li> <li>• 1440 x 900 @ 60Hz</li> <li>• 1400 x 1050 @ 60Hz</li> <li>• 1360 x 768 @ 60Hz</li> <li>• 1280 x 1024 @ 50, 60Hz</li> <li>• 1280 x 960 @ 50, 60Hz</li> <li>• 1280 x 800 @ 50, 60Hz</li> <li>• 1280 x 768 @ 50, 60Hz</li> <li>• 1280 x 720 @ 50, 60Hz</li> <li>• 1152 x 864 @ 60Hz</li> <li>• 1024 x 768 @ 50, 60Hz</li> <li>• 800 x 600 @ 56, 60Hz</li> <li>• 720 x 576 @ 50Hz</li> <li>• 720 x 480 @ 60Hz</li> <li>• 640 x 480 @ 50, 60Hz</li> <li>• 640 x 400 @ 60Hz</li> </ul>
Power Adapter <sup>2</sup>	Input Voltage	AC 100-240V, 50/60Hz
Display Area	Full Scan (H x V)	344.21 x 193.62 mm (13.55" x 7.62")
Operating conditions	Temperature	0° C to 40° C (32° F to 104° F)
	Humidity	20% to 90% (non-condensing)
	Altitude	10,000 feet (3.048 km)



Item	Category	Specifications
Storage conditions	Temperature	-20° C to 60° C (-4° F to 140° F)
	Humidity	5% to 90% (non-condensing)
	Altitude	40, 000 feet (12.1 km)
Dimensions	Physical (W x H x D)	358.918 x 226.682~314.48 x 19 mm (14.13" x 8.92"~12.38" x 0.8")
Weight	Physical	0.98 kg (2.18 lbs)
Power saving modes	On <sup>3</sup>	7W (Typical) without Audio 7.6W (Typical) with Audio
	Off	≤ 0.3W (Max)

<sup>1</sup> Do not set the graphics card in your computer to exceed these timing modes; doing so may result in permanent damage to the display.

<sup>2</sup> Please use the power adapter from ViewSonic® or an authorized source only.

<sup>3</sup> The test condition follows EEL standards.

**HDMI**™ HIGH-DEFINITION MULTIMEDIA INTERFACE The terms HDMI, HDMI High-Definition Multimedia Interface, HDMI trade dress and the HDMI Logos are trademarks or registered trademarks of HDMI Licensing Administrator, Inc.

# Glossary

This section describes the standard glossary of terms used in all LCD display models. All terms are listed in alphabetical order.

**NOTE:** Some terms may not be applicable to your monitor.

## A

### **Advanced DCR**

Advanced DCR technology automatically detects the image signal and intelligently controls the backlight brightness and color to improve on the ability to make the black blacker in a dark scene, and make the white whiter in a bright environment.

### **Adaptive Sync**

Adaptive Sync technology puts an end to choppy gameplay and broken frames with fluid, artifact-free performance at virtually any frame rate.

### **Audio Adjust**

Adjusts the volume, mutes the sound, or toggles between inputs if you have more than one source.

### **Auto Detect**

If the current input source has no signal, the monitor will automatically switch to the next input option. This function, on some models, is disabled by default.

## B

### **Black Stabilization**

ViewSonic's Black Stabilization provides heightened visibility and detail by brightening dark scenes.

### **Blue Light Filter**

Adjusts the filter that blocks high-energy blue light for a more comfortable viewing experience.

### **Boot Up Screen**

Turning off the boot screen will disable the on-screen message from displaying when turning on the monitor.

### **Brightness**

Adjusts background black levels of the screen image.

## C Color Adjust

Provides several color adjustment modes to help adjust the color settings to fit the user's needs.

### Color Range

The monitor can detect the input signal color range automatically. You can manually change the color range options to fit the correct color range if the colors are not displayed correctly.

Options	Description
Auto	The monitor automatically recognizes the color format and black and white levels.
Full Range	The color range of the black and white levels are full.
Limited Range	The color range of the black and white levels are limited.

### Color Space

Allows users to choose which color space they would like to use for monitor color output (RGB, YUV).

### Color Temperature

Allows users to select specific color temperature settings to further customize their viewing experience.

Panel Default	Panel Original Status
sRGB	Standard color space used for the Windows system.
Bluish	Set the color temperature to 9300K.
Cool	Set the color temperature to 7500K.
Native	Default color temperature. Recommended for general use.
Warm	Set the color temperature to 5000K.

### Contrast

Adjusts the difference between the image background (black level) and the foreground (white level).

## G Gamma

Allows users to manually adjust the brightness level of the monitor's grayscale levels. There are six selections: 1.8, 2.0, 2.2, 2.4, 2.6, and 2.8.

## H Hue

Adjusts the tint of each color (red, green, blue, cyan, magenta, and yellow).

## **I** Information

Displays the timing mode (video signal input) coming from the graphics card in the computer, the LCD model number, the serial number, and the ViewSonic® website URL. See your graphics card's user guide for instructions on changing the resolution and refresh rate (vertical frequency).

**NOTE:** VESA 1024 x 768 @ 60Hz, for example, means that the resolution is 1024 x 768 and the refresh rate is 60Hz.

## **Input Select**

Toggles between the various input options that are available for the monitor.

## **M** Manual Image Adjust

Displays the "Manual Image Adjust" menu. You can manually set a variety of image quality adjustments.

## **Memory Recall**

Returns the adjustments back to factory settings if the display is operating in a factory preset timing mode listed in the "Specifications" of this manual.

### **NOTE:**

- (Exception) This control does not affect changes made in the "Language Select" or "Power Lock" setting.
- Memory Recall is the default as-shipped display configuration and settings. Memory Recall is the setting in which the product qualifies for ENERGY STAR®. Any changes to default as-shipped display configuration and settings would change the energy consumption, and may increase energy consumption beyond the limits required for ENERGY STAR® qualification, as applicable. ENERGY STAR® is a set of power-saving guidelines issued by the U.S. Environmental Protection Agency (EPA). ENERGY STAR® is a joint program of the U.S. Environmental Protection Agency and the U.S. Department of Energy helping us all save money and protect the environment through energy efficient products and practices.



## O

### **Offset**

Adjusts black levels for red, green, and blue. The gain and offset functions allow users to control the white balance for the upmost control when manipulating contrast and dark scenes.

### **OSD Pivot**

Sets the monitor OSD Menu display direction.

### **Overscan**

Refers to a cropped image on your monitor's screen. A setting on your monitor zooms in on movie content, so that you cannot see the outermost edges of the film.

## P

### **Power Indicator**

The light that displays whether the monitor is on or off. This setting also controls the lighting on the stand. Users can turn off the lighting effect under "Power Indicator". Additionally, the power indicator displays an average color directly interpreting the input color signal received on screen.

## Q

### **Quick Access**

Quickly initiate some functions and modes through the Quick Access key and menu. Users can also define which functions or modes they prefer in the Quick Access Menu via the **Setup Menu** in OSD. The function/mode will be enabled as soon as the light-bar moves on the item, and will disable after removing the light-bar.

## R

### **Recall**

Resets the ViewMode monitor settings.

### **Resolution Notice**

The notice tells users that the current viewing resolution is not the correct native resolution. This notice will appear in the display settings window when setting up the display resolution.

## **S Setup Menu**

Adjusts On-Screen Display (OSD) Menu settings. Many of these settings can activate on-screen display notifications so users do not have to reopen the menu.

### **Sharpness**

Adjusts the picture quality of the monitor.

## **V ViewMode**

ViewSonic's unique ViewMode feature offers "Game", "Movie", "Web", "Text", "MAC", and "Mono" presets. These presets are specifically designed to deliver an optimized viewing experience for different screen applications.

### **ViewScale**

Gamers have the ability to adjust the display size of the image on the monitor, allowing for a "best fit" scenario.

## Troubleshooting

This section describes some common problems that you may experience when using the monitor.

Problem or Issue	Possible Solutions
No power	<ul style="list-style-type: none"><li>• Make sure you have turned on the monitor by pressing the <b>Power</b> button.</li><li>• Make sure the power cord is properly and securely connected to the monitor and power outlet.</li><li>• Plug another electrical device into the power outlet to verify that the outlet is supplying power.</li></ul>
Power is On, but no image appears on screen	<ul style="list-style-type: none"><li>• Make sure the video cable connecting the monitor to the computer is properly and securely connected.</li><li>• Adjust the brightness and contrast settings.</li><li>• Make sure the correct input source is selected.</li></ul>
Wrong or abnormal colors	<ul style="list-style-type: none"><li>• If any colors (red, green, or blue) are missing, check the video cable to make sure it is properly and securely connected. Loose or broken pins in the cable connector could cause an improper connection.</li><li>• Connect the monitor to another computer.</li><li>• If you have an older graphics card, contact ViewSonic® for a non-DDC adapter.</li></ul>
Screen image is too light or dark	<ul style="list-style-type: none"><li>• Adjust brightness and contrast settings via the OSD Menu.</li><li>• Reset the monitor to factory settings.</li></ul>
Screen image cuts in and out	<ul style="list-style-type: none"><li>• Make sure the correct input source is selected.</li><li>• Check for bent or broken pins in the video cable connector.</li><li>• Make sure the video cable connecting the monitor to the computer is properly and securely connected.</li></ul>
Screen image is blurred	<ul style="list-style-type: none"><li>• Adjust the resolution to the correct Aspect Ratio.</li><li>• Reset the monitor to factory settings.</li></ul>

Problem or Issue	Possible Solutions
The screen isn't centered correctly	<ul style="list-style-type: none"> <li>• Adjust the horizontal and vertical controls via the OSD Menu.</li> <li>• Check the Aspect Ratio.</li> <li>• Reset the monitor to factory settings.</li> </ul>
The screen appears yellow	<ul style="list-style-type: none"> <li>• Make sure the "Blue Light Filter" is Off.</li> </ul>
The OSD Menu does not appear on the screen/the OSD controls are inaccessible	<ul style="list-style-type: none"> <li>• Check whether the OSD Menu is locked.</li> <li>• Turn off the monitor, unplug the power cord, plug it back in, and then turn on the monitor.</li> <li>• Reset the monitor to factory settings.</li> </ul>
Control panel keys do not work	<ul style="list-style-type: none"> <li>• Press only one key at a time.</li> <li>• Restart the computer.</li> </ul>
Some menus aren't selectable in the OSD	<ul style="list-style-type: none"> <li>• Adjust the ViewMode or the input source.</li> <li>• Reset the monitor to factory settings.</li> </ul>
No audio output	<ul style="list-style-type: none"> <li>• If using ear-/headphones, ensure the mini stereo jack is connected.</li> <li>• Make sure the volume is not muted, nor set to 0.</li> <li>• Check the Audio Input setting.</li> </ul>
The monitor will not adjust	<ul style="list-style-type: none"> <li>• Make sure there are no obstructions near or on the monitor, and that there is adequate spacing.</li> <li>• For more information, see "Adjusting the Viewing Angle".</li> </ul>
USB devices connected to the monitor do not work	<ul style="list-style-type: none"> <li>• Make sure the USB cable is connected properly.</li> <li>• Try changing to another USB port (if applicable).</li> <li>• Some USB devices require a higher electric current; connect the device directly to the computer.</li> </ul>
The external device is connected, but no image appears on the screen	<ul style="list-style-type: none"> <li>• Make sure the Power is On</li> <li>• Adjust brightness and contrast via the OSD Menu.</li> <li>• Check the connecting cable and make sure it is properly and securely connected. Loose or broken pins in the cable connector could cause an improper connection.</li> </ul>



# Maintenance

## General Precautions

- Make sure the monitor is turned off and the power cable is unplugged from the power outlet.
- Never spray or pour any liquid directly onto the screen or case.
- Handle the monitor with care, as a darker-colored monitor, if scuffed, may show marks more clearly than a lighter-colored monitor.

## Cleaning the Screen

- Wipe the screen with a clean, soft, lint-free cloth. This removes dust and other particles.
- If the screen is still not clean, apply a small amount of non-ammonia, non-alcohol based glass cleaner onto a clean, soft, lint-free cloth; then wipe the screen.

## Cleaning the Case

- Use a soft, dry cloth.
- If the case is still not clean, apply a small amount of non-ammonia, non-alcohol based, mild non-abrasive detergent onto a clean, soft, lint-free cloth, then wipe the surface.

## Disclaimer

- ViewSonic® does not recommend the use of any ammonia or alcohol-based cleaners on the display screen or case. Some chemical cleaners have been reported to damage the screen and/or case of the monitor.
- ViewSonic® will not be liable for damage resulting from use of any ammonia or alcohol-based cleaners.

# Regulatory and Service Information

## Compliance Information

This section addresses all connected requirements and statements regarding regulations. Confirmed corresponding applications shall refer to nameplate labels and relevant markings on the unit.

### FCC Compliance Statement

This device complies with part 15 of FCC Rules. Operation is subject to the following two conditions: (1) this device may not cause harmful interference, and (2) this device must accept any interference received, including interference that may cause undesired operation. This equipment has been tested and found to comply with the limits for a Class B digital device, pursuant to part 15 of the FCC Rules.

These limits are designed to provide reasonable protection against harmful interference in a residential installation. This equipment generates, uses, and can radiate radio frequency energy, and if not installed and used in accordance with the instructions, may cause harmful interference to radio communications. However, there is no guarantee that interference will not occur in a particular installation. If this equipment does cause harmful interference to radio or television reception, which can be determined by turning the equipment off and on, the user is encouraged to try to correct the interference by one or more of the following measures:

- Reorient or relocate the receiving antenna.
- Increase the separation between the equipment and receiver.
- Connect the equipment into an outlet on a circuit different from that to which the receiver is connected.
- Consult the dealer or an experienced radio/TV technician for help.

**Warning:** You are cautioned that changes or modifications not expressly approved by the party responsible for compliance could void your authority to operate the equipment.

### Industry Canada Statement

CAN ICES-003(B) / NMB-003(B)

### CE Conformity for European Countries

 The device complies with the EMC Directive 2014/30/EU and Low Voltage Directive 2014/35/EU.

**The following information is only for EU-member states:**

The mark shown to the right is in compliance with the Waste Electrical and Electronic Equipment Directive 2012/19/EU (WEEE). The mark indicates the requirement NOT to dispose of the equipment as unsorted municipal waste, but use the return and collection systems according to local law.



**Declaration of RoHS2 Compliance**

This product has been designed and manufactured in compliance with Directive 2011/65/EU of the European Parliament and the Council on restriction of the use of certain hazardous substances in electrical and electronic equipment (RoHS2 Directive) and is deemed to comply with the maximum concentration values issued by the European Technical Adaptation Committee (TAC) as shown below:

Substance	Proposed Maximum Concentration	Actual Concentration
Lead (Pb)	0.1%	< 0.1%
Mercury (Hg)	0.1%	< 0.1%
Cadmium (Cd)	0.01%	< 0.01%
Hexavalent Chromium (Cr6 <sup>+</sup> )	0.1%	< 0.1%
Polybrominated biphenyls (PBB)	0.1%	< 0.1%
Polybrominated diphenyl ethers (PBDE)	0.1%	< 0.1%
Bis (2-ethylhexyl) phthalate (DEHP)	0.1%	< 0.1%
Butyl benzyl phthalate (BBP)	0.1%	< 0.1%
Dibutyl phthalate (DBP)	0.1%	< 0.1%
Diisobutyl phthalate (DIBP)	0.1%	< 0.1%

**Certain components of products as stated above are exempted under the Annex III of the RoHS2 Directives as noted below. Examples of exempted components are:**

- Copper alloy containing up to 4% lead by weight.
- Lead in high melting temperature type solders (i.e. lead-based alloys containing 85% by weight or more lead).
- Electrical and electronic components containing lead in a glass or ceramic other than dielectric ceramic in capacitors, e.g. piezoelectronic devices, or in a glass or ceramic matrix compound.
- Lead in dielectric ceramic in capacitors for a rated voltage of 125V AC or 250V DC or higher.

## **Indian Restriction of Hazardous Substances**

Restriction on Hazardous Substances statement (India). This product complies with the “India E-waste Rule 2011” and prohibits use of lead, mercury, hexavalent chromium, polybrominated biphenyls or polybrominated diphenyl ethers in concentrations exceeding 0.1 weight % and 0.01 weight % for cadmium, except for the exemptions set in Schedule 2 of the Rule.

## **Product Disposal at End of Product Life**

ViewSonic® respects the environment and is committed to working and living green. Thank you for being part of Smarter, Greener Computing. Please visit the ViewSonic® website to learn more.

### **USA & Canada:**

<https://www.viewsonic.com/us/company/green/go-green-with-viewsonic/#recycle-program>

### **Europe:**

<https://www.viewsoniceurope.com/eu/support/call-desk/>

### **Taiwan:**

<https://recycle.epa.gov.tw/>

## Copyright Information

Copyright© ViewSonic® Corporation, 2022. All rights reserved.

Macintosh and Power Macintosh are registered trademarks of Apple Inc.

Microsoft, Windows, and the Windows logo are registered trademarks of Microsoft Corporation in the United States and other countries.

ViewSonic®, the three birds logo, OnView, ViewMatch, and ViewMeter are registered trademarks of ViewSonic® Corporation.

VESA is a registered trademark of the Video Electronics Standards Association. DPMS, DisplayPort, and DDC are trademarks of VESA.

The terms HDMI, HDMI High-Definition Multimedia Interface, HDMI Trade Dress and the HDMI Logos are trademarks or registered trademarks of HDMI Licensing Administrator, Inc.

**Disclaimer:** ViewSonic® Corporation shall not be liable for technical or editorial errors or omissions contained herein; nor for incidental or consequential damages resulting from furnishing this material, or the performance or use of this product.

In the interest of continuing product improvement, ViewSonic® Corporation reserves the right to change product specifications without notice. Information in this document may change without notice.

No part of this document may be copied, reproduced, or transmitted by any means, for any purpose without prior written permission from ViewSonic® Corporation.

## Customer Service

For technical support or product service, see the table below or contact your reseller.

**NOTE:** You will need the product's serial number.

Country/ Region	Website	Country/ Region	Website
<b>Asia Pacific &amp; Africa</b>			
Australia	<a href="http://www.viewsonic.com/au/">www.viewsonic.com/au/</a>	Bangladesh	<a href="http://www.viewsonic.com/bd/">www.viewsonic.com/bd/</a>
中国 (China)	<a href="http://www.viewsonic.com.cn">www.viewsonic.com.cn</a>	香港 (繁體中文)	<a href="http://www.viewsonic.com/hk/">www.viewsonic.com/hk/</a>
Hong Kong (English)	<a href="http://www.viewsonic.com/hk-en/">www.viewsonic.com/hk-en/</a>	India	<a href="http://www.viewsonic.com/in/">www.viewsonic.com/in/</a>
Indonesia	<a href="http://www.viewsonic.com/id/">www.viewsonic.com/id/</a>	Israel	<a href="http://www.viewsonic.com/il/">www.viewsonic.com/il/</a>
日本 (Japan)	<a href="http://www.viewsonic.com/jp/">www.viewsonic.com/jp/</a>	Korea	<a href="http://www.viewsonic.com/kr/">www.viewsonic.com/kr/</a>
Malaysia	<a href="http://www.viewsonic.com/my/">www.viewsonic.com/my/</a>	Middle East	<a href="http://www.viewsonic.com/me/">www.viewsonic.com/me/</a>
Myanmar	<a href="http://www.viewsonic.com/mm/">www.viewsonic.com/mm/</a>	Nepal	<a href="http://www.viewsonic.com/np/">www.viewsonic.com/np/</a>
New Zealand	<a href="http://www.viewsonic.com/nz/">www.viewsonic.com/nz/</a>	Pakistan	<a href="http://www.viewsonic.com/pk/">www.viewsonic.com/pk/</a>
Philippines	<a href="http://www.viewsonic.com/ph/">www.viewsonic.com/ph/</a>	Singapore	<a href="http://www.viewsonic.com/sg/">www.viewsonic.com/sg/</a>
臺灣 (Taiwan)	<a href="http://www.viewsonic.com/tw/">www.viewsonic.com/tw/</a>	ประเทศไทย	<a href="http://www.viewsonic.com/th/">www.viewsonic.com/th/</a>
Việt Nam	<a href="http://www.viewsonic.com/vn/">www.viewsonic.com/vn/</a>	South Africa & Mauritius	<a href="http://www.viewsonic.com/za/">www.viewsonic.com/za/</a>
<b>Americas</b>			
United States	<a href="http://www.viewsonic.com/us">www.viewsonic.com/us</a>	Canada	<a href="http://www.viewsonic.com/us">www.viewsonic.com/us</a>
Latin America	<a href="http://www.viewsonic.com/la">www.viewsonic.com/la</a>		
<b>Europe</b>			
Europe	<a href="http://www.viewsonic.com/eu/">www.viewsonic.com/eu/</a>	France	<a href="http://www.viewsonic.com/fr/">www.viewsonic.com/fr/</a>
Deutschland	<a href="http://www.viewsonic.com/de/">www.viewsonic.com/de/</a>	Қазақстан	<a href="http://www.viewsonic.com/kz/">www.viewsonic.com/kz/</a>
Россия	<a href="http://www.viewsonic.com/ru/">www.viewsonic.com/ru/</a>	España	<a href="http://www.viewsonic.com/es/">www.viewsonic.com/es/</a>
Türkiye	<a href="http://www.viewsonic.com/tr/">www.viewsonic.com/tr/</a>	Україна	<a href="http://www.viewsonic.com/ua/">www.viewsonic.com/ua/</a>
United Kingdom	<a href="http://www.viewsonic.com/uk/">www.viewsonic.com/uk/</a>		

# Limited Warranty

ViewSonic® Display

## What the warranty covers:

ViewSonic® warrants its products to be free from defects in material and workmanship during the warranty period. If a product proves to be defective in material or workmanship during the warranty period, ViewSonic® will, at its sole option, and as your sole remedy, repair or replace the product with a similar product. Replacement Product or parts may include remanufactured or refurbished parts or components. The repair or replacement unit or parts or components will be covered by the balance of the time remaining on the customer's original limited warranty and the warranty period will not be extended. ViewSonic® provides no warranty for any third-party software whether included with the product or installed by the customer, installation of any unauthorized hardware parts or components (e.g. Projector Lamps). (Please refer to: "What the warranty excludes and does not cover" section).

## How long the warranty is effective:

ViewSonic® displays are warranted for between 1 and 3 years, depending on your country of purchase, for all parts including the light source and for all labor from the date of the first consumer purchase.

## Who the warranty protects:

This warranty is valid only for the first consumer purchaser.

## What the warranty excludes and does not cover:

- Any product on which the serial number has been defaced, modified, or removed.
- Damage, deterioration, or malfunction resulting from:
  - » Accident, misuse, neglect, fire, water, lightning, or other acts of nature, unauthorized product modification, or failure to follow instructions supplied with the product.
  - » Repair or attempted repair by anyone not authorized by ViewSonic®.
  - » Damage to or loss of any programs, data, or removable storage media.
  - » Normal wear and tear.
  - » Removal or installation of the product.
- Software or data loss occurring during repair or replacement.
- Any damage of the product due to shipment.

- Causes external to the product, such as electric power fluctuations or failure.
- Use of supplies or parts not meeting ViewSonic’s specifications.
- Failure of owner to perform periodic product maintenance as stated in the User Guide.
- Any other cause which does not relate to a product defect.
- Damage caused by static (non-moving) images displayed for lengthy periods of time (also referred to as image burn-in).
- Software - Any third-party software included with the product or installed by the customer.
- Hardware/Accessories/Parts/Components – Installation of any unauthorized hardware, accessories, consumable parts or components (e.g. Projector Lamps).
- Damage to, or abuse of, the coating on the surface of the display through inappropriate cleaning as described in the product User Guide.
- Removal, installation, and set-up service charges, including wall-mounting of the product.

**How to get service:**

- For information about receiving service under warranty, contact ViewSonic® Customer Support (Please refer to the “Customer Service” page). You will need to provide your product’s serial number.
- To obtain warranty service, you will be required to provide: (a) the original dated sales slip, (b) your name, (c) your address, (d) a description of the problem, and (e) the serial number of the product.
- Take or ship the product, freight prepaid, in the original container to an authorized ViewSonic® service center or ViewSonic®.
- For additional information or the name of the nearest ViewSonic® service center, contact ViewSonic®.

**Limitation of implied warranties:**

There are no warranties, express or implied, which extend beyond the description contained herein including the implied warranty of merchantability and fitness for a particular purpose.



**Exclusion of damages:**

ViewSonic's liability is limited to the cost of repair or replacement of the product. ViewSonic® shall not be liable for:

- Damage to other property caused by any defects in the product, damages based upon inconvenience, loss of use of the product, loss of time, loss of profits, loss of business opportunity, loss of goodwill, interference with business relationships, or other commercial loss, even if advised of the possibility of such damages.
- Any other damages, whether incidental, consequential or otherwise.
- Any claim against the customer by any other party.
- Repair or attempted repair by anyone not authorized by ViewSonic®.

**Effect of state law:**

This warranty gives you specific legal rights, and you may also have other rights which vary from state to state. Some states do not allow limitations on implied warranties and/or do not allow the exclusion of incidental or consequential damages, so the above limitations and exclusions may not apply to you.

**Sales outside the U.S.A. and Canada:**

For warranty information and service on ViewSonic® products sold outside of the U.S.A. and Canada, contact ViewSonic® or your local ViewSonic® dealer.

The warranty period for this product in mainland China (Hong Kong, Macao, and Taiwan Excluded) is subject to the terms and conditions of the Maintenance Guarantee Card.

For users in Europe and Russia, full details of warranty provided can be found at: <http://www.viewsonic.com/eu/> under "Support/Warranty Information".

# Mexico Limited Warranty

## ViewSonic® Display

### **What the warranty covers:**

ViewSonic® warrants its products to be free from defects in material and workmanship, under normal use, during the warranty period. If a product proves to be defective in material or workmanship during the warranty period, ViewSonic® will, at its sole option, repair or replace the product with a like product. Replacement product or parts may include remanufactured or refurbished parts or components & accessories.

### **How long the warranty is effective:**

ViewSonic® LCD displays are warranted for between 1 and 3 years, depending on your country of purchase, for all parts including the light source and for all labour from the date of the first consumer purchase.

### **Who the warranty protects:**

This warranty is valid only for the first consumer purchaser.

### **What the warranty excludes and does not cover:**

- Any product on which the serial number has been defaced, modified or removed.
- Damage, deterioration, or malfunction resulting from:
  - » Accident, misuse, neglect, fire, water, lightning, or other acts of nature, unauthorized product modification, unauthorized attempted repair, or failure to follow instructions supplied with the product.
  - » Causes external to the product, such as electrical power fluctuations or failure.
  - » Use of supplies or parts not meeting ViewSonic®'s specifications.
  - » Normal wear and tear.
  - » Any other cause which does not relate to a product defect.
- Any product exhibiting a condition commonly known as “image burn-in” which results when a static image is displayed on the product for an extended period of time.
- Removal, installation, insurance, and set-up service charges.

**How to get service:**

For information about receiving service under warranty, contact ViewSonic® Customer Support (Please refer to the attached “Customer Service” page). You will need to provide your product’s serial number, so please record the product information in the space provided below on your purchase for your future use. Please retain your receipt of proof of purchase to support your warranty claim.

**For Your Records**

Product Name: \_\_\_\_\_ Model Number: \_\_\_\_\_

Document Number: \_\_\_\_\_ Serial Number: \_\_\_\_\_

Purchase Date: \_\_\_\_\_ Extended Warranty Purchase? \_\_\_\_\_ (Y/N)

If so, what date does warranty expire? \_\_\_\_\_

- To obtain warranty service, you will be required to provide (a) the original dated sales slip, (b) your name, (c) your address, (d) a description of the problem, and (e) the serial number of the product.
- Take or ship the product, in the original container packaging, to an authorized ViewSonic® service center.
- Round trip transportation costs for in-warranty products will be paid by ViewSonic®.

**Limitation of implied warranties:**

There are no warranties, express or implied, which extend beyond the description contained herein including the implied warranty of merchantability and fitness for a particular purpose.

**Exclusion of damages:**

ViewSonic®’s liability is limited to the cost of repair or replacement of the product.

ViewSonic® shall not be liable for:

- Damage to other property caused by any defects in the product, damages based upon inconvenience, loss of use of the product, loss of time, loss of profits, loss of business opportunity, loss of goodwill, interference with business relationships, or other commercial loss, even if advised of the possibility of such damages.
- Any other damages, whether incidental, consequential or otherwise.
- Any claim against the customer by any other party.
- Repair or attempted repair by anyone not authorized by ViewSonic®.

Contact Information for Sales & Authorized Service (Centro Autorizado de Servicio) within Mexico:	
<b>Name, address, of manufacturer and importers:</b> México, Av. de la Palma #8 Piso 2 Despacho 203, Corporativo Interpalmas, Col. San Fernando Huixquilucan, Estado de México Tel: (55) 3605-1099 <a href="http://www.viewsonic.com/la/soporte/index.htm">http://www.viewsonic.com/la/soporte/index.htm</a>	
NÚMERO GRATIS DE ASISTENCIA TÉCNICA PARA TODO MÉXICO: 001.866.823.2004	
<b>Hermosillo:</b> Distribuciones y Servicios Computacionales SA de CV. Calle Juárez 284 local 2 Col. Bugambilias C.P: 83140 Tel: 01-66-22-14-9005 E-Mail: <a href="mailto:disc2@hmo.megared.net.mx">disc2@hmo.megared.net.mx</a>	<b>Villahermosa:</b> Compumantenimientos Garantizados, S.A. de C.V. AV. GREGORIO MENDEZ #1504 COL, FLORIDA C.P. 86040 Tel: 01 (993) 3 52 00 47 / 3522074 / 3 52 20 09 E-Mail: <a href="mailto:compumantenimientos@prodigy.net.mx">compumantenimientos@prodigy.net.mx</a>
<b>Puebla, Pue. (Matriz):</b> RENTA Y DATOS, S.A. DE C.V. Domicilio: 29 SUR 721 COL. LA PAZ 72160 PUEBLA, PUE. Tel: 01(52).222.891.55.77 CON 10 LINEAS E-Mail: <a href="mailto:datos@puebla.megared.net.mx">datos@puebla.megared.net.mx</a>	<b>Veracruz, Ver.:</b> CONEXION Y DESARROLLO, S.A DE C.V. Av. Americas # 419 ENTRE PINZÓN Y ALVARADO Fracc. Reforma C.P. 91919 Tel: 01-22-91-00-31-67 E-Mail: <a href="mailto:gacosta@qplus.com.mx">gacosta@qplus.com.mx</a>
<b>Chihuahua:</b> Soluciones Globales en Computación C. Magisterio # 3321 Col. Magisterial Chihuahua, Chih. Tel: 4136954 E-Mail: <a href="mailto:Cefeo@soluglobales.com">Cefeo@soluglobales.com</a>	<b>Cuernavaca:</b> Compusupport de Cuernavaca SA de CV Francisco Leyva # 178 Col. Miguel Hidalgo C.P. 62040, Cuernavaca Morelos Tel: 01 777 3180579 / 01 777 3124014 E-Mail: <a href="mailto:aquevedo@compusupportcva.com">aquevedo@compusupportcva.com</a>
<b>Distrito Federal:</b> QPLUS, S.A. de C.V. Av. Coyoacán 931 Col. Del Valle 03100, México, D.F. Tel: 01(52)55-50-00-27-35 E-Mail : <a href="mailto:gacosta@qplus.com.mx">gacosta@qplus.com.mx</a>	<b>Guadalajara, Jal.:</b> SERVICRECE, S.A. de C.V. Av. Niños Héroes # 2281 Col. Arcos Sur, Sector Juárez 44170, Guadalajara, Jalisco Tel: 01(52)33-36-15-15-43 E-Mail: <a href="mailto:mmiranda@servicrece.com">mmiranda@servicrece.com</a>
<b>Guerrero Acapulco:</b> GS Computación (Grupo Sesicomp) Progreso #6-A, Colo Centro 39300 Acapulco, Guerrero Tel: 744-48-32627	<b>Monterrey:</b> Global Product Services Mar Caribe # 1987, Esquina con Golfo Pérsico Fracc. Bernardo Reyes, CP 64280 Monterrey N.L. México Tel: 8129-5103 E-Mail: <a href="mailto:aydeem@gps1.com.mx">aydeem@gps1.com.mx</a>
<b>MERIDA:</b> ELECTROSER Av Reforma No. 403Gx39 y 41 Mérida, Yucatán, México CP97000 Tel: (52) 999-925-1916 E-Mail: <a href="mailto:rrrb@sureste.com">rrrb@sureste.com</a>	<b>Oaxaca, Oax.:</b> CENTRO DE DISTRIBUCION Y SERVICIO, S.A. de C.V. Murguía # 708 P.A., Col. Centro, 68000, Oaxaca Tel: 01(52)95-15-15-22-22 Fax: 01(52)95-15-13-67-00 E-Mail: <a href="mailto:gpotai2001@hotmail.com">gpotai2001@hotmail.com</a>
<b>Tijuana:</b> STD Av Ferrocarril Sonora #3780 L-C Col 20 de Noviembre Tijuana, Mexico	<b>FOR USA SUPPORT:</b> ViewSonic® Corporation 381 Brea Canyon Road, Walnut, CA. 91789 USA Tel: 800-688-6688 E-Mail: <a href="http://www.viewsonic.com">http://www.viewsonic.com</a>



**ViewSonic®**