

# datavideo

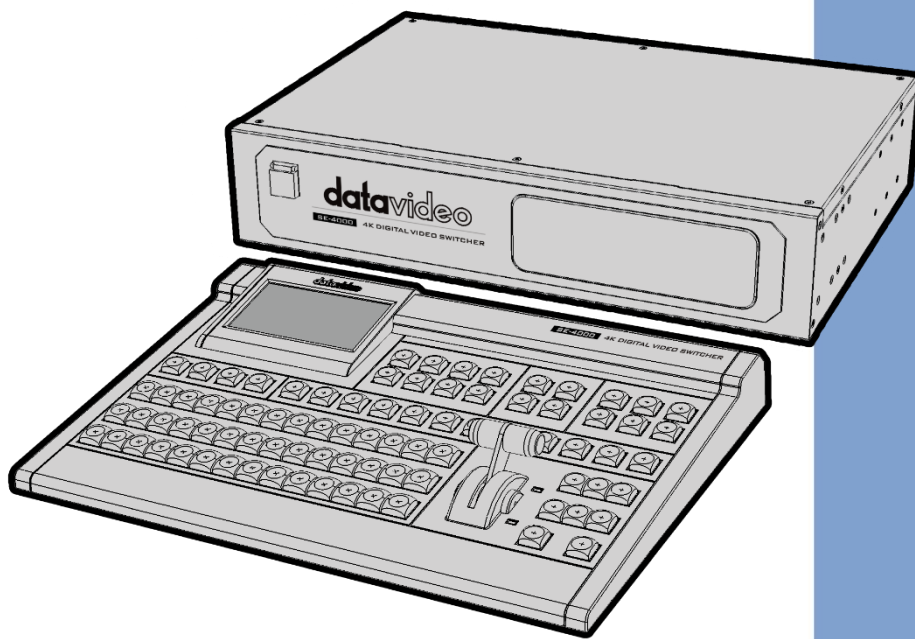

4K DIGITAL VIDEO SWITCHER  
SE-4000

## Instruction Manual

[www.datavideo.com](http://www.datavideo.com)

# Table of Contents

<b>FCC COMPLIANCE STATEMENT .....</b>	<b>6</b>
<b>WARNINGS AND PRECAUTIONS.....</b>	<b>6</b>
<b>WARRANTY .....</b>	<b>7</b>
<i>STANDARD WARRANTY.....</i>	7
<i>THREE YEAR WARRANTY.....</i>	7
<b>DISPOSAL.....</b>	<b>8</b>
<b>CHAPTER 1 INTRODUCTION .....</b>	<b>9</b>
1.1 MAIN UNIT OVERVIEW.....	10
1.2 CONTROL PANEL OVERVIEW.....	12
1.3 CONNECTING THE POWER SUPPLY .....	17
<b>CHAPTER 2 PREPARATION.....</b>	<b>18</b>
2.1 CONNECTING DEVICES.....	18
<i>Connect Control Panel to Main Unit .....</i>	<i>18</i>
Local Connection .....	18
Network Connection.....	21
<i>Connecting Video and Audio Input Devices.....</i>	<i>23</i>
<i>When linking via tally connection .....</i>	<i>24</i>
<i>Connecting Video and Audio Output Devices.....</i>	<i>24</i>
2.2 NETWORK SETUP.....	25
<i>Static IP Configuration .....</i>	<i>25</i>
<i>DHCP Mode .....</i>	<i>25</i>
Fallback IP.....	26
2.3 MULTI VIEW.....	27
<b>CHAPTER 3 DEVICE INITIALIZATION .....</b>	<b>28</b>
3.1 USER MEMORY .....	28
3.2 WIPE EFFECTS.....	30
3.3 PIP .....	30
<i>PIP Icon.....</i>	<i>31</i>
<i>PIP Setting.....</i>	<i>31</i>
3.4 AUX.....	32
3.5 STILL .....	32
3.6 KEYSER.....	33
<i>Adjust .....</i>	<i>34</i>
3.7 CROSS POINT.....	35
3.8 AUDIO.....	36
<b>CHAPTER 4 SOFTWARE SETUP FOR SWITCHER.....</b>	<b>38</b>
4.1 HOME .....	39
4.2 USER.....	40
4.3 STILL .....	40
4.4 CLIP .....	41

4.5	LOGO .....	42
4.6	ANI-LOGO .....	42
4.7	SETUP.....	43
<b>CHAPTER 5</b>	<b>GRAPHICAL USER INTERFACE.....</b>	<b>44</b>
5.1	START.....	52
	<i>Transition</i> .....	52
	<i>Type</i> .....	52
	<i>Matte</i> .....	53
	<i>Wipe Effects</i> .....	54
	<i>Wipe Border</i> .....	54
	<i>Wipe Position</i> .....	55
5.2	KEYER.....	56
	<i>Keyer</i> .....	56
	<i>Keyer Control</i> .....	56
	<i>Key Source</i> .....	58
	<i>Mask</i> .....	58
5.3	CHROMA.....	59
	<i>Keyer</i> .....	59
	<i>Key Source</i> .....	60
	<i>Key Tie</i> .....	60
	<i>CK Setup</i> .....	63
	<i>Mask</i> .....	64
5.4	P-IN-P.....	65
	<i>P-in-P</i> .....	65
	<i>Position</i> .....	66
	<i>Crop</i> .....	67
	<i>Border</i> .....	67
	<i>Shade Matte (Dual Color Border)</i> .....	69
5.5	INPUTS.....	71
	<i>Input</i> .....	72
	<i>Proc Amp</i> .....	73
	<i>Audio</i> .....	73
	<i>Crosspoint</i> .....	74
	<i>Audio XPT</i> .....	74
5.6	OUTPUTS .....	75
	<i>Outputs</i> .....	75
	<i>Multiviewer</i> .....	76
	<i>Tally Mode</i> .....	77
	<i>GPI Out</i> .....	78
5.7	AUDIO .....	78
	<i>Audio</i> .....	78
	<i>PGM Audio</i> .....	79
	<i>Analog Out</i> .....	80
5.8	FILES .....	81
	<i>User Mems</i> .....	81
	Load Memory .....	82

Save Memory.....	82
<i>Still</i> .....	82
Load Still .....	83
Save Still.....	83
Grab Still .....	84
Delete Still .....	84
Loading still images .....	85
<i>Stinger</i> .....	86
<i>Logo</i> .....	86
Load Logo .....	87
Clear Logo .....	87
Delete Logo.....	88
Positioning.....	88
<i>Ani Logo</i> .....	88
Load Ani Logo .....	89
Clear Ani Logo.....	89
Delete Ani Logo .....	90
Positioning.....	90
5.9    SETUP.....	90
<i>Standard</i> .....	90
<i>Genlock</i> .....	91
<i>Keyboard</i> .....	92
<i>Auto Save</i> .....	92
<i>Factory Def</i> .....	93
<i>Language</i> .....	93
<i>Network</i> .....	94
<i>Software</i> .....	95
<b>CHAPTER 6    BASIC OPERATION.....</b>	<b>96</b>
6.1    VIDEO SWITCHING .....	96
<i>Program and Preview rows</i> .....	96
<i>Source Row</i> .....	96
<i>Black and Background MATTE View</i> .....	97
6.2    TRANSITIONS .....	97
<i>CUT Button</i> .....	98
<i>MIX Button</i> .....	98
<i>WIPE Button</i> .....	98
<i>Stinger Button</i> .....	98
<i>FTB Button</i> .....	99
<i>T-Bar</i> .....	99
<i>AUTO Button</i> .....	99
<i>Trans BG</i> .....	99
<i>Trans PVW</i> .....	99
<i>WIPE Selection MENU</i> .....	100
6.3    MANAGING STILL PICTURES.....	101
<i>Grabbing &amp; Saving a Still to Memory</i> .....	101
<i>Loading an existing Still from Memory</i> .....	101
<i>Deleting a saved Still from Memory</i> .....	101

<i>FS – Frame Store Button</i> .....	101
6.4    ENABLING STILL LOGO .....	101
<i>Loading an existing Logo from Memory</i> .....	102
<i>Importing Still Logo from the PC</i> .....	103
6.5    ENABLING LOGO ANIMATION .....	105
<i>Loading an existing Ani-Logo from Memory</i> .....	105
<i>Importing Animated Logo from the PC</i> .....	106
<b>CHAPTER 7    ADVANCED OPERATION .....</b>	<b>109</b>
7.1    PICTURE-IN-PICTURE AND DOWNSTREAM KEY.....	110
<i>Picture-In-Picture</i> .....	111
Assigning a video source to a PIP window.....	111
Assigning a video source to a PIP window using shortcut keys.....	112
<i>Character Generator</i> .....	113
7.2    PLACING TEXT ON THE VIDEO USING LUMA KEY .....	114
7.3    INSERTION OF PEOPLE ONTO BACKGROUNDS (CHROMA Key).....	116
<b>CHAPTER 8    APPENDICES .....</b>	<b>122</b>
APPENDIX 1    TALLY OUTPUTS .....	122
APPENDIX 2    GPI / GPO CONNECTIONS .....	124
APPENDIX 3    RS-232 SERIAL PORT PINOUT .....	125
APPENDIX 4    FIRMWARE UPDATE .....	126
<i>Firmware Upgrade Procedures</i> .....	126
Main Unit.....	126
Control Panel.....	126
<i>T-Bar Calibration</i> .....	127
APPENDIX 5    FREQUENTLY-ASKED QUESTIONS.....	128
APPENDIX 6    DIMENSIONS & WEIGHT.....	129
APPENDIX 7    SPECIFICATIONS.....	130
<b>SERVICE AND SUPPORT .....</b>	<b>132</b>

### **Disclaimer of Product & Services**

The information offered in this instruction manual is intended as a guide only. At all times, Datavideo Technologies will try to give correct, complete and suitable information. However, Datavideo Technologies cannot exclude that some information in this manual, from time to time, may not be correct or may be incomplete. This manual may contain typing errors, omissions or incorrect information. Datavideo Technologies always recommend that you double check the information in this document for accuracy before making any purchase decision or using the product. Datavideo Technologies is not responsible for any omissions or errors, or for any subsequent loss or damage caused by using the information contained within this manual. Further advice on the content of this manual or on the product can be obtained by contacting your local Datavideo Office or dealer.

# FCC Compliance Statement

This device complies with part 15 of the FCC rules. Operation is subject to the following two conditions:

- (1) This device may not cause harmful interference, and
- (2) This device must accept any interference received, including interference that may cause undesired operation.

## Warnings and Precautions



1. Read all of these warnings and save them for later reference.
2. Follow all warnings and instructions marked on this unit.
3. Unplug this unit from the wall outlet before cleaning. Do not use liquid or aerosol cleaners. Use a damp cloth for cleaning.
4. Do not use this unit in or near water.
5. Do not place this unit on an unstable cart, stand, or table. The unit may fall, causing serious damage.
6. Slots and openings on the cabinet top, back, and bottom are provided for ventilation. To ensure safe and reliable operation of this unit, and to protect it from overheating, do not block or cover these openings. Do not place this unit on a bed, sofa, rug, or similar surface, as the ventilation openings on the bottom of the cabinet will be blocked. This unit should never be placed near or over a heat register or radiator. This unit should not be placed in a built-in installation unless proper ventilation is provided.
7. This product should only be operated from the type of power source indicated on the marking label of the AC adapter. If you are not sure of the type of power available, consult your Datavideo dealer or your local power company.
8. Do not allow anything to rest on the power cord. Do not locate this unit where the power cord will be walked on, rolled over, or otherwise stressed.
9. If an extension cord must be used with this unit, make sure that the total of the ampere ratings on the products plugged into the extension cord do not exceed the extension cord rating.
10. Make sure that the total amperes of all the units that are plugged into a single wall outlet do not exceed 15 amperes.
11. Never push objects of any kind into this unit through the cabinet ventilation slots, as they may touch dangerous voltage points or short out parts that could result in risk of fire or electric shock. Never spill liquid of any kind onto or into this unit.
12. Except as specifically explained elsewhere in this manual, do not attempt to service this product yourself. Opening or removing covers that are marked "Do Not Remove" may expose you to dangerous voltage points or other risks, and will void your warranty. Refer all service issues to qualified service personnel.
13. Unplug this product from the wall outlet and refer to qualified service personnel under the following conditions:
  - a. When the power cord is damaged or frayed;

- b. When liquid has spilled into the unit;
- c. When the product has been exposed to rain or water;
- d. When the product does not operate normally under normal operating conditions. Adjust only those controls that are covered by the operating instructions in this manual; improper adjustment of other controls may result in damage to the unit and may often require extensive work by a qualified technician to restore the unit to normal operation;
- e. When the product has been dropped or the cabinet has been damaged;
- f. When the product exhibits a distinct change in performance, indicating a need for service.

## Warranty

### ***Standard Warranty***

- Datavideo equipment is guaranteed against any manufacturing defects for one year from the date of purchase.
- The original purchase invoice or other documentary evidence should be supplied at the time of any request for repair under warranty.
- The product warranty period begins on the purchase date. If the purchase date is unknown, the product warranty period begins on the thirtieth day after shipment from a Datavideo office.
- All non-Datavideo manufactured products (product without Datavideo logo) have only one year warranty from the date of purchase.
- Damage caused by accident, misuse, unauthorized repairs, sand, grit or water is not covered under warranty.
- Viruses and malware infections on the computer systems are not covered under warranty.
- Any errors that are caused by unauthorized third-party software installations, which are not required by our computer systems, are not covered under warranty.
- All mail or transportation costs including insurance are at the expense of the owner.
- All other claims of any nature are not covered.
- All accessories including headphones, cables, batteries, metal parts, housing, cable reel and consumable parts are not covered under warranty.
- Warranty only valid in the country or region of purchase.
- Your statutory rights are not affected.

### ***Three Year Warranty***

- All Datavideo products purchased after July 1st, 2017 qualify for a free two years extension to the standard warranty, providing the product is registered with Datavideo **within 30** days of purchase.



- Certain parts with limited lifetime expectancy such as LCD panels, DVD drives, Hard Drive, Solid State Drive, SD Card, USB Thumb Drive, Lighting, Non-PCIe Card and third party provided PC components are covered for 1 year.
- The three-year warranty must be registered on Datavideo's official website or with your local Datavideo office or one of its authorized distributors within 30 days of purchase.

## Disposal

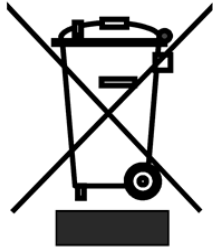

### **For EU Customers only - WEEE Marking**

This symbol on the product or on its packaging indicates that this product must not be disposed of with your other household waste. Instead, it is your responsibility to dispose of your waste equipment by handing it over to a designated collection point for the recycling of waste electrical and electronic equipment. The separate collection and recycling of your waste equipment at the time of disposal will help to conserve natural resources and ensure that it is recycled in a manner that protects human health and the environment. For more information about where you can drop off your waste equipment for recycling, please contact your local city office, your household waste disposal service or the shop where you purchased the product.



**CE Marking** is the symbol as shown on the left of this page. The letters "CE" are the abbreviation of French phrase "Conformité Européene" which literally means "European Conformity". The term initially used was "EC Mark" and it was officially replaced by "CE Marking" in the Directive 93/68/EEC in 1993. "CE Marking" is now used in all EU official documents.



# Chapter 1 Introduction

The SE-4000 is an 8-input live production switcher supporting the real 4K60/50P video resolution. With a variety of video input and output ports such as 12G-SDI and HDMI 2.0 interface, you will be able to easily produce a sophisticated and professional live event.

With a built-in 5-inch LCD touch panel, the SE-4000 provides a user friendly user interface, which is very easy to operate and set up. The SE-4000 switcher also has powerful and easy-to-use effects such as Chroma/Luma Key, DSK, PIP, Wipe Generator, still stores and logo insertion.

The Crosspoint assignment (XPT) provides alternative I/O combinations by allowing you to reroute physical I/O ports to the corresponding control panel buttons.

## **Features**

- UHD 4K60/50p signals on input and output
- 8 live channels: 8x 12G-SDI + 4x HDMI (select 8 from 12)
- 7 outputs: 4x 12G-SDI +3x HDMI
- Variety of video and audio input/output
- Supports 4K60/50P with scaling on each available input
- 4 x XLR Analogue Audio Inputs
- 2 x XLR Analogue Audio Outputs
- Integrated 5" Touchscreen Display, easy to operate.
- 4 x Upstream Keyers and 2 x Downstream Keyers
- 2 x Picture-in-Picture (supported resolutions are 4K, 1080p and 1080i)
- Crosspoint assignment (XPT)
- Wipe, Mix, Cut Transitions
- CG Title Creator
- Tally output

## 1.1 Main Unit Overview

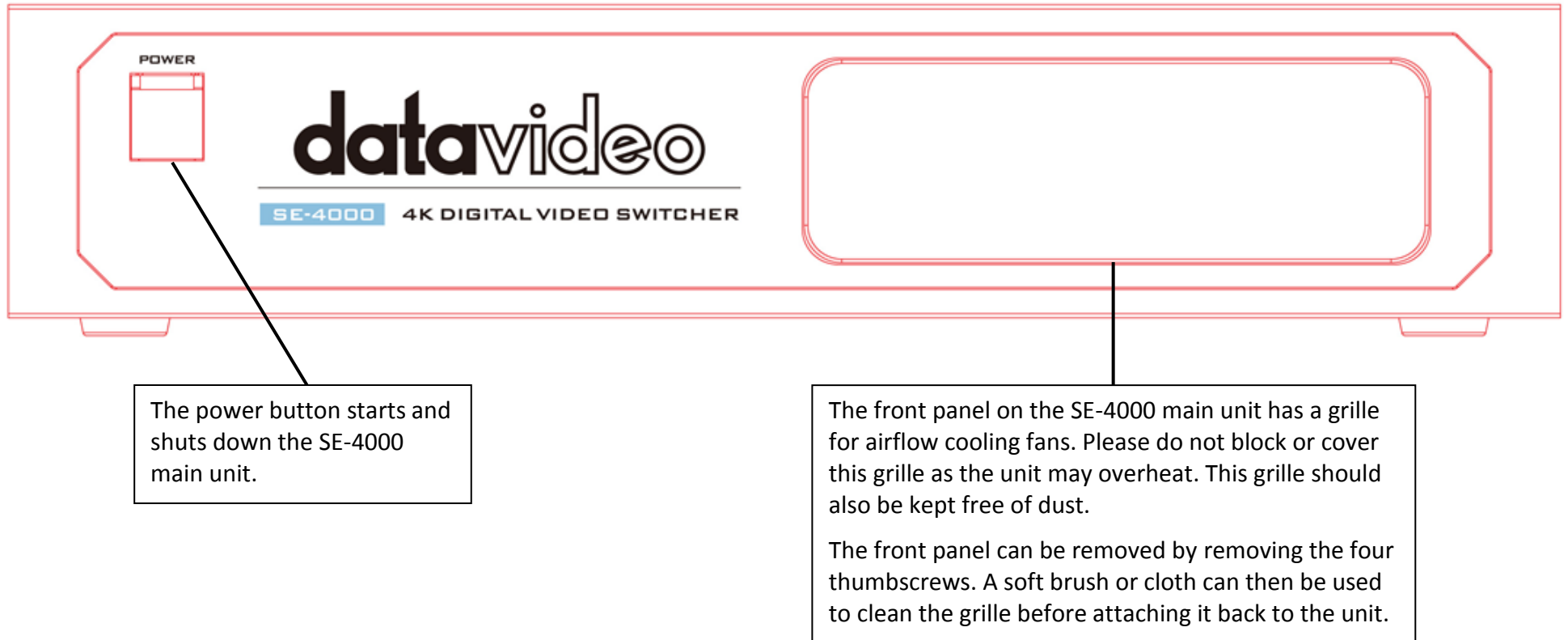

**AUDIO OUT**  
Supports two channels of the XLR Balanced Audio output.

**AUDIO IN**  
Supports four channels of the XLR Balanced Audio Input.

See [Section 5.7 Audio](#) for audio setup.

**GPI OUT**  
The [GPI socket](#) can be used for simple external control.

See [Appendix 2](#) for more details.

**RS-232 REMOTE**  
Connect a custom keyboard controller to this port.

See [Appendix 3](#) for details or contact your local Datavideo distributors.

**TALLY OUT**  
The SE-4000 Tally Output port provides bi-colour tally information to a number of other Datavideo products, such as the ITC-100 eight channel talkback system or the Datavideo TLM range of monitors.

See [Appendix 1](#) and [Section 5.6](#) for more details.

**DC IN**  
Connect the supplied 12 V PSU to this 4 PIN XLR socket

Pin 1 = GND ( - )  
Pin 2 = NC  
Pin 3 = NC  
Pin 4 = VCC ( + )

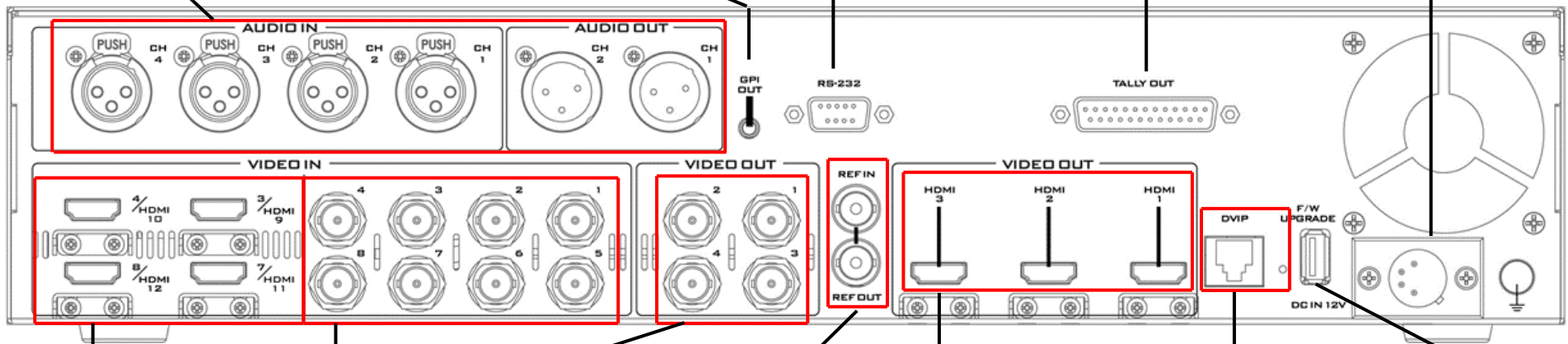

**HDMI Video Inputs 9 – 12**  
The HDMI inputs are labelled. The numbers 3/4/7/8 are the respective SDI counterparts of the HDMI video inputs 9 – 12.

**SDI Video Inputs 1 – 8**  
The upper row of 12G-SDI inputs are labelled 1~4. The lower row of SDI inputs are labelled 5~8.

**SDI Video Outputs**  
The SDI video outputs are user-defined outputs. Each of these outputs has the option to be:

- Multiview
- Program
- Preview
- Program + DSK
- Clean Program
- Clean Preview
- Input 1 – 8

**SYNC I/O**  
The SE-4000 can be synchronized with other studio equipment such as cameras. **REF IN** accepts Tri-level or Black Burst sync. **REF LOOP** can be used to pass the sync signal to other studio equipment such as cameras or recorders. This function is currently under development.

**HDMI Video Outputs**  
The SDI/HDMI video outputs are user-defined. Each of these outputs has the option to be:

- (1) Multiview
- (2) Program
- (3) Preview
- (4) Program + DSK
- (5) Clean Program
- (6) Clean Preview
- (7) Input 1 – 8

**DVIP Port**  
The DVIP port can be used to connect the main unit to the switcher's control panel or the network.

If the DVIP port is used to directly connect the control panel, open the GUI and follow the menu path Setup → Network to set the IP address. You can also use a needle to push the reset hole next to the DVIP port to restore the default IP address. Push the reset button then hold for about 5 to 10 seconds until the machine reboots itself to restore the IP address to 192.168.100.101.

The main unit and the control panel can also be connected to any network for remote control. See [Section 2.2 Network Setup](#) for setup instructions.







**USB FW Upgrade Port**  
Connect the USB drive containing the main unit's latest firmware files to this port and start the firmware upgrade process on the GUI.

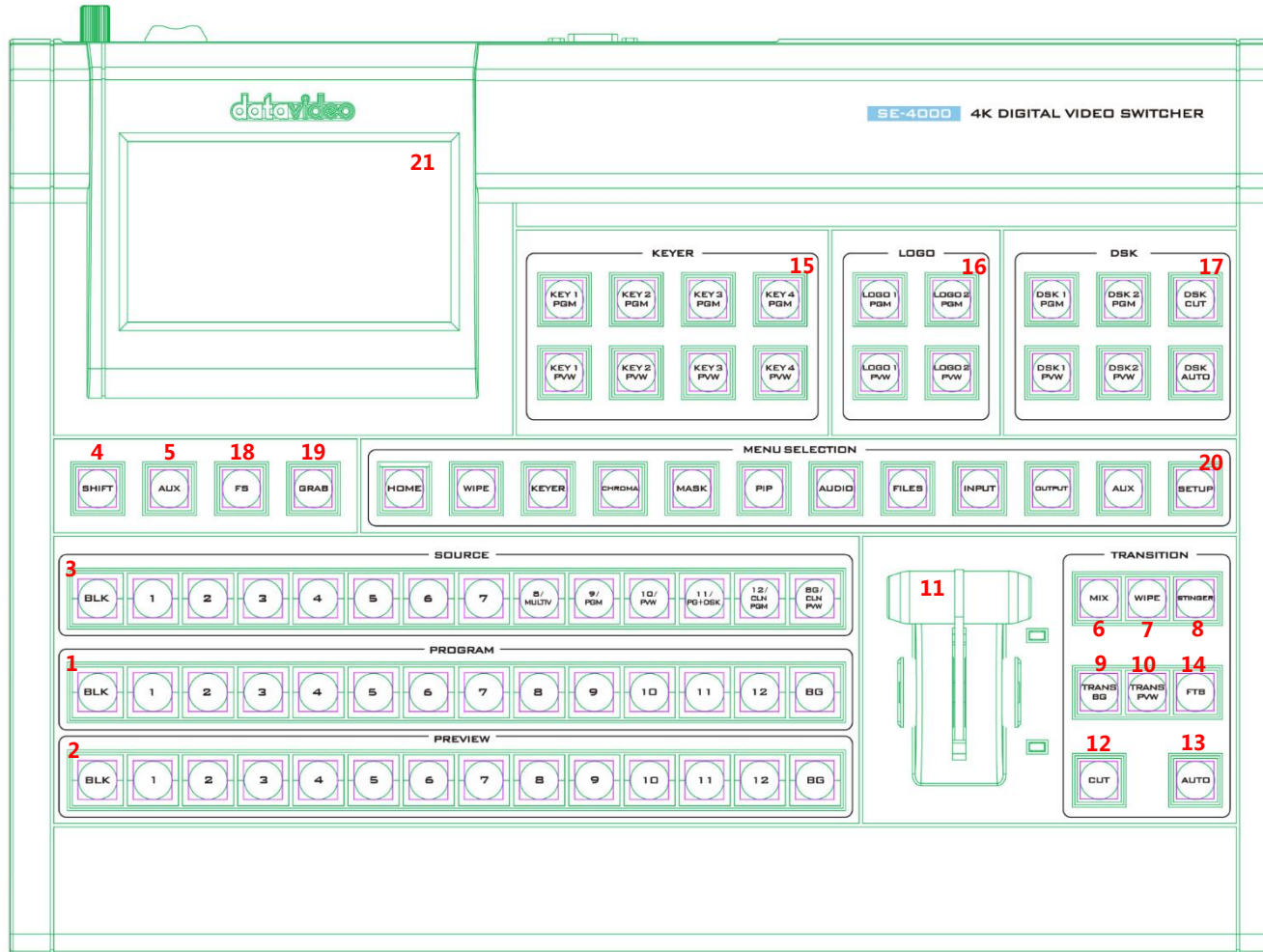

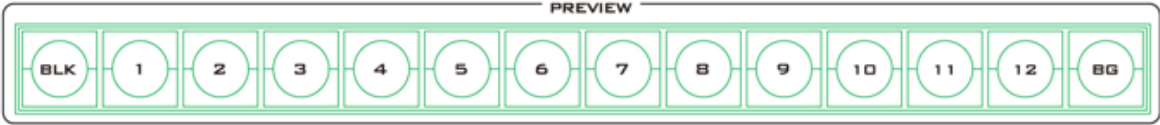
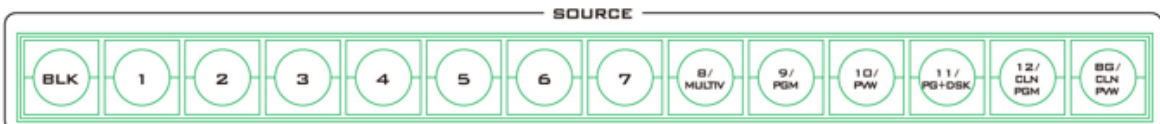



**Note:** See [Firmware Update](#) section for details.



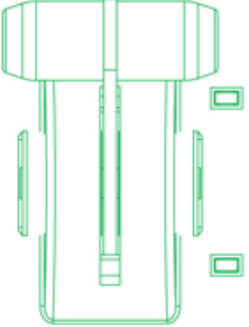

## 1.2 Control Panel Overview

Perform video switching and other relevant controls on the **Control Panel**.

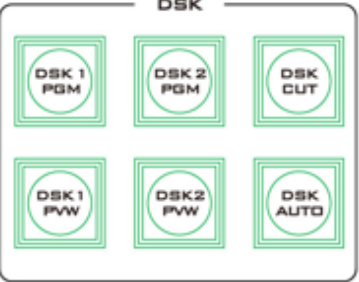

<b>Video Switching</b>	
<b>1. Program row</b>	Selection of a program video source (see <a href="#">Section 6.1 Video Switching</a> for detailed instructions).
	
<b>2. Preview row</b>	Selection of a preview video source (see <a href="#">Section 6.1 Video Switching</a> for detailed instructions).
	
<b>3. Source row</b>	Select a video source for Program/Preview channels (see <a href="#">Section 6.1 Video Switching</a> for detailed instructions).
	
	<b>4. SHIFT Button</b> Press the <b>SHIFT</b> button to activate the Source row for switching channels 3/4/7/8 between SDI and HDMI interfaces. <b>Note:</b> See the <a href="#">Source Row</a> section for detailed instructions.
	<b>5. AUX Button</b> Press the <b>AUX</b> button to activate the Source row for assigning a video source to an output channel. <b>Note:</b> See the <a href="#">Source Row</a> section for detailed instructions.
<b>Transitions</b>	
	<b>6. MIX Button</b> Selection of MIX transition effect (See the <a href="#">Mix Button</a> section for detailed instructions).
	<b>7. WIPE Button</b> Selection WIPE transition effect (See the <a href="#">WIPE Button</a> section for detailed instructions).
	<b>8. STINGER Button</b> Press to enable animated transition effect (See the <a href="#">STINGER Button</a> section for detailed instructions).
	<b>9. TRANS BG Button</b> Turning on the Trans BG button allows you to activate the MIX, WIPE or Stinger transition with the background image/video (See the <a href="#">TRANS BG Button</a> section for detailed instructions).

	<p><b>10. TRANS PVW Button</b> Once enabled, you can then test the effect of a chosen <b>MIX</b>, <b>WIPE</b> or <b>Stinger</b> transition on the Preview Monitor (See the <a href="#">TRANS PVW Button</a> section for detailed instructions).</p>
	<p><b>11. T-Bar – Manual Transition</b> Move the T-Bar up or down to switch between Preview and Program videos (See the <a href="#">T-Bar</a> section for detailed instructions).</p>
	<p><b>12. CUT Button</b> A hard cut between video sources (See the <a href="#">CUT Button</a> section for detailed instructions).</p>
	<p><b>13. Auto Take</b> Press to trigger automatic transition (See the <a href="#">AUTO Button</a> section for detailed instructions).</p>
	<p><b>14. FTB Button (Fade to Black)</b> Fades the program view to black once pressed (See the <a href="#">FTB Button</a> section for detailed instructions).</p>
<b>Keys</b>	
	<p><b>15. Keyer Selection</b> Enabling the pre-assigned keyers (Chroma, Luma, Linear, DSK and PIP) on Program and Preview views.  <b>Note:</b> See <a href="#">Chapter 7 Advanced Operation</a> for detailed descriptions of various keyer functions.</p>
<b>Logo</b>	
	<p><b>16. Logos 1 &amp; 2</b> Logo insertion on preview and program outputs once enabled.  <b>Note:</b> Logos will not be transitioned as the <b>CUT</b> or <b>AUTO</b> button is pressed, nor will it be transitioned as the T-Bar is pushed. See <a href="#">Section 6.4 Enabling Still Logo</a> and <a href="#">Section 6.5 Enabling Logo Animation</a> for detailed descriptions of the logo function.</p>

DSK	
 <p style="text-align: center;">DSK</p> <p>The image shows a 2x3 grid of buttons labeled DSK 1 PGM, DSK 2 PGM, DSK CUT, DSK 1 PVW, DSK 2 PVW, and DSK AUTO.</p>	<p><b>17. DSK Selection</b> Enabling DSK on preview and program outputs.</p> <p><b>Note:</b> See <a href="#">Chapter 7 Advanced Operation</a> for detailed descriptions of the DSK function.</p>
Still Grab and Save	
 <p>The image shows a square button with a double border and the text 'FS' in the center.</p>	<p><b>18. Frame Store Button</b> Press and hold the FS button then press a channel button on the Preview row to switch the selected channel to a pre-loaded still picture.</p> <p><b>Note:</b> See <a href="#">Section 6.3 Managing Still Pictures</a> for detailed instructions.</p>
 <p>The image shows a square button with a double border and the text 'GRAB' in the center.</p>	<p><b>19. Grab Button</b> Press to capture images from the Program output.</p> <p><b>Note:</b> See <a href="#">Section 6.3 Managing Still Pictures</a> for detailed instructions.</p>
Graphical User Interface	
<p><b>20. GUI Control (Menu Selection)</b></p>	<p>The GUI control buttons are designed for opening the GUI on the built-in 5 inch monitor and navigating through the sub menus. Press the HOME button to open the Home Menu page or the sub menu buttons to directly access the corresponding sub menus.</p>
 <p>MENU SELECTION</p> <p>The image shows a row of 12 buttons labeled HOME, WIPE, KEYER, CHROMA, MASK, PIP, AUDIO, FILES, INPUT, OUTPUT, AUX, and SETUP.</p>	
 <p>The image shows a large rectangular frame representing a touch screen. The 'data video' logo is visible in the top left corner.</p>	<p><b>21. 5 inch Touch Screen</b> A touchscreen user interface allowing you to access various functions of the switcher via the GUI menu (See <a href="#">Chapter 5 Graphical User Interface</a> for detailed instructions).</p>

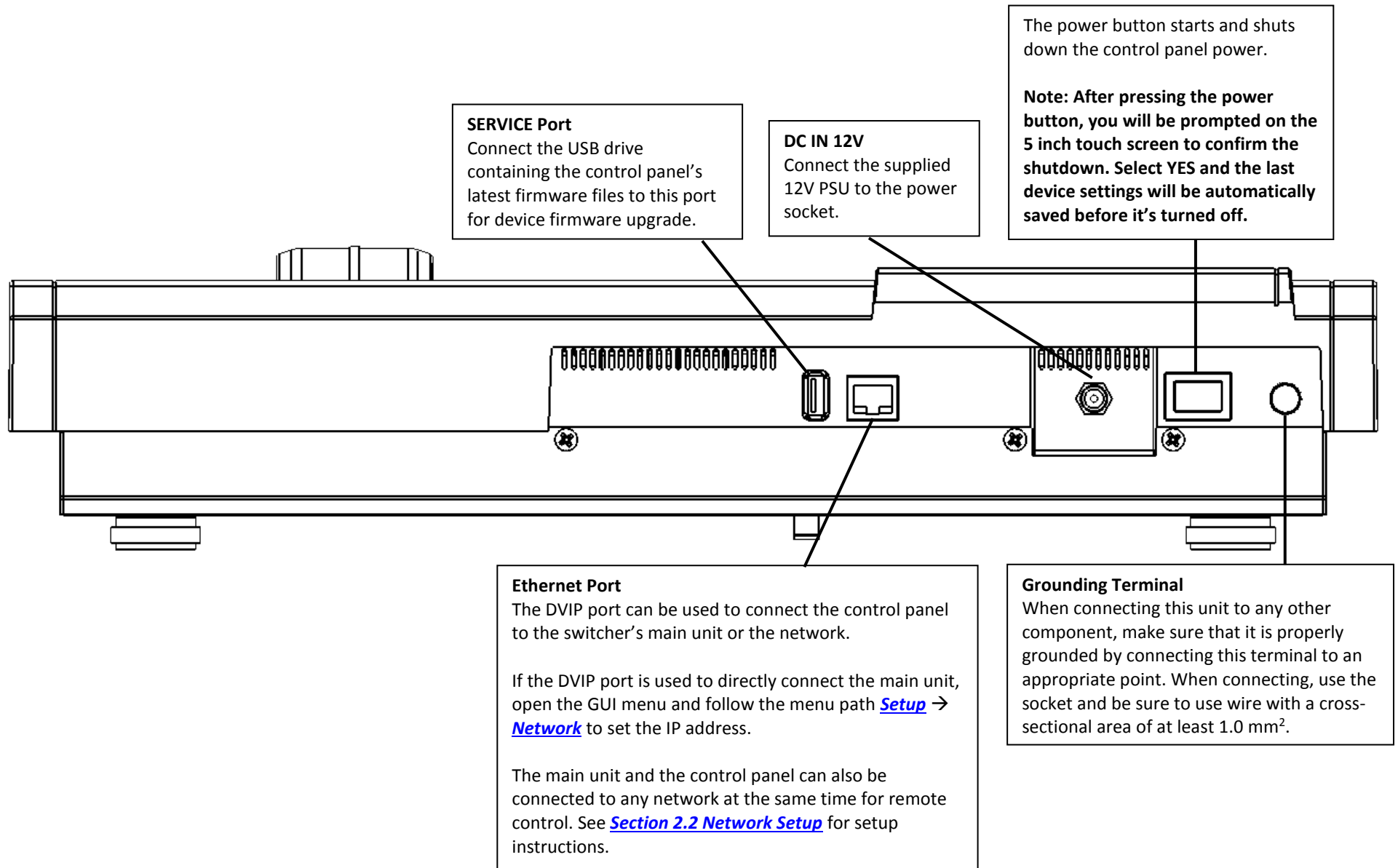



### 1.3 Connecting the Power Supply

Connect the DC output plug of the supplied AC adapter to the DC IN 12V connector on the rear of the switcher's main unit and control panel and then connect the AC adapter to a power supply.

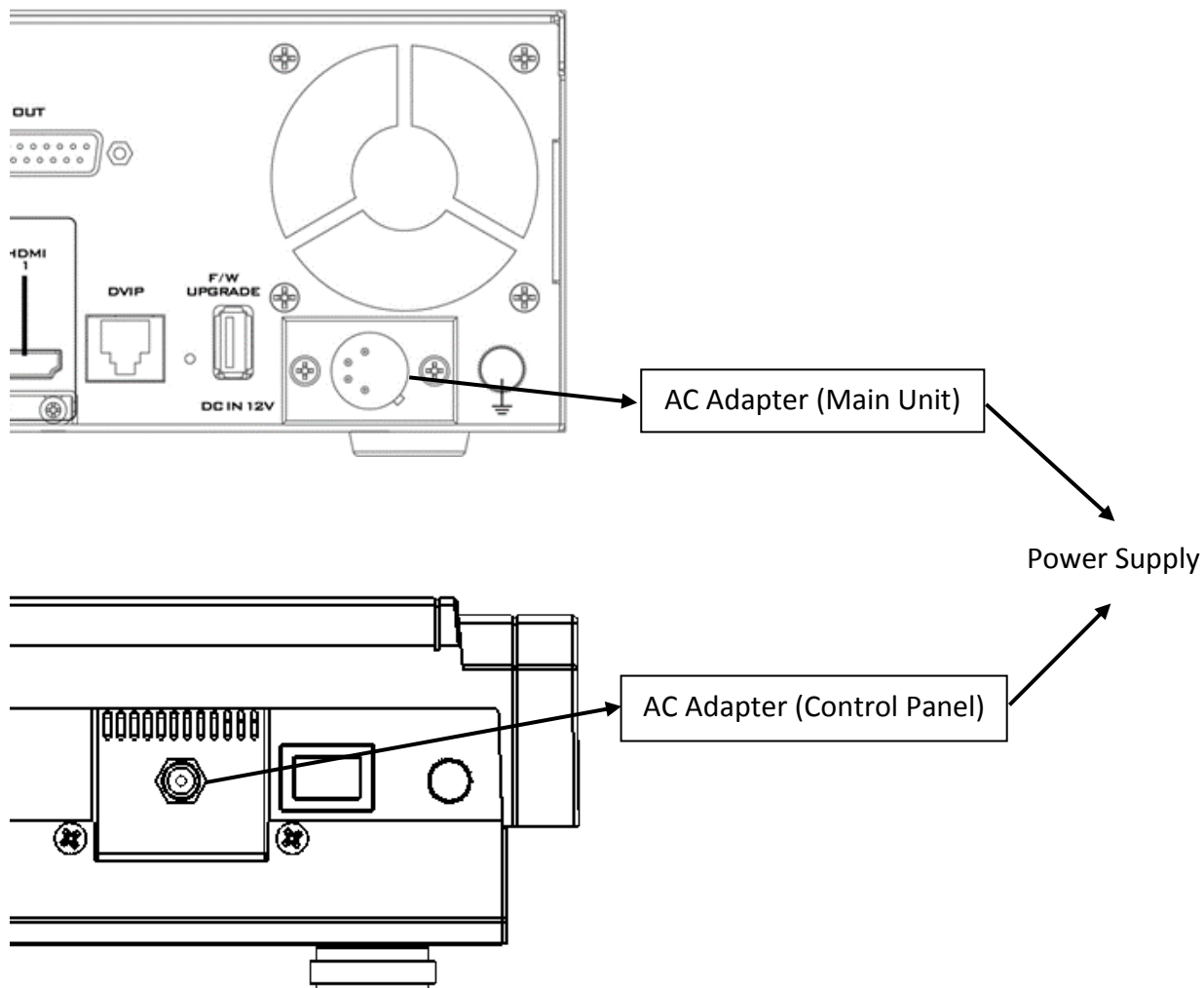

To start, first locate and turn **ON** the respective power switches at the rear of the control panel as well as the front panel of the main processing unit.

To shut off the switcher, simply turn **OFF** both power switches.

## Chapter 2 Preparation

In this chapter, we will describe various essential devices to be connected to the switcher in order to complete the system setup. If you possess the skills for setting up the production system, feel free to skip this chapter and proceed to [Chapter 6: Basic Operation](#).

### 2.1 Connecting Devices

In this section, we will provide brief descriptions of various connections for your video production setup. We will discuss connections listed below:

- Main unit and control panel
- Input devices
- Tally connection
- Output devices

#### ***Connect Control Panel to Main Unit***

There are two methods to connect the SE-4000's main unit to the control panel. You can establish point-to-point or network connection between the two devices.

##### ***Local Connection***

Use a standard Ethernet cable to connect DVIP ports of the switcher's main unit and control panel. The default mode of connection is fixed IP. The IP addresses of the main unit and the control panel are 192.168.100.101 and 192.168.100.102 respectively with a subnet mask of 255.255.255.0. If necessary, you can open the GUI then go to Setup → Network to modify the IP address. See [Section 5.9 Setup](#) for instructions.

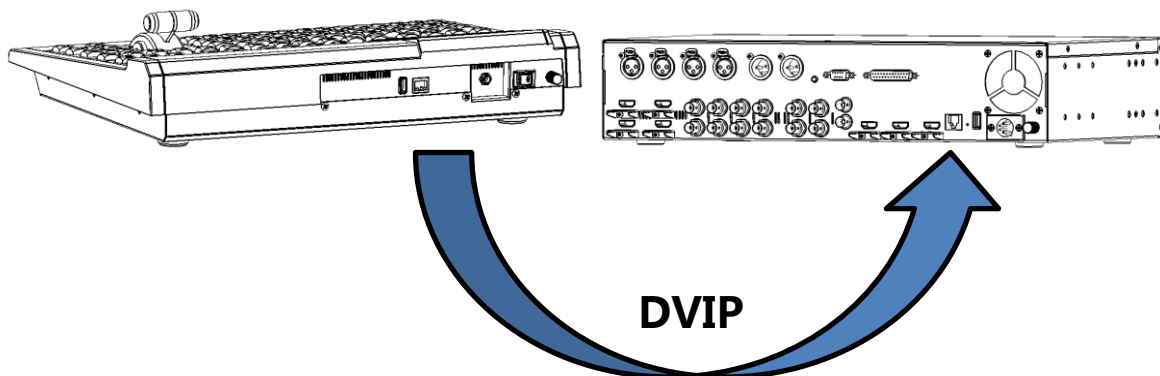

After establishing point-to-point connection between the main unit and the control panel, simply turn on the respective power switches. After the switcher has been successfully booted up, you should see the GUI on the 5 inch touch screen as shown below. Tap the gear icon located at the top right corner to open the main menu.

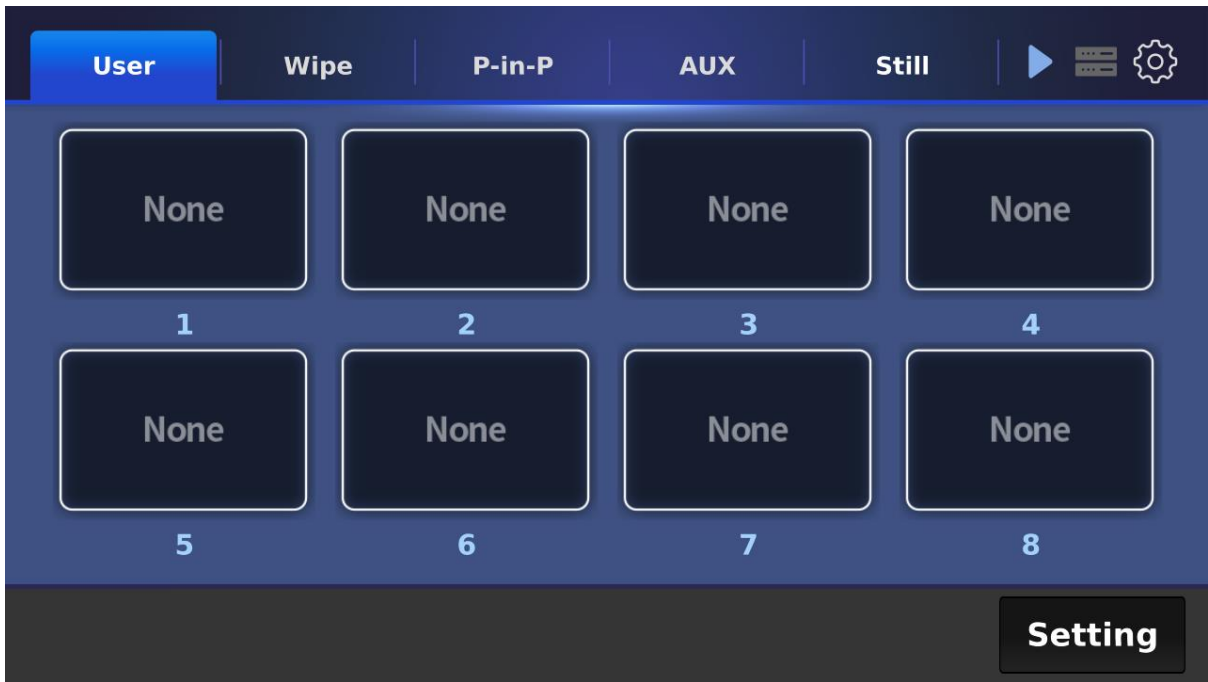

Tap **SCAN** on the main menu to search for the main unit to connect.

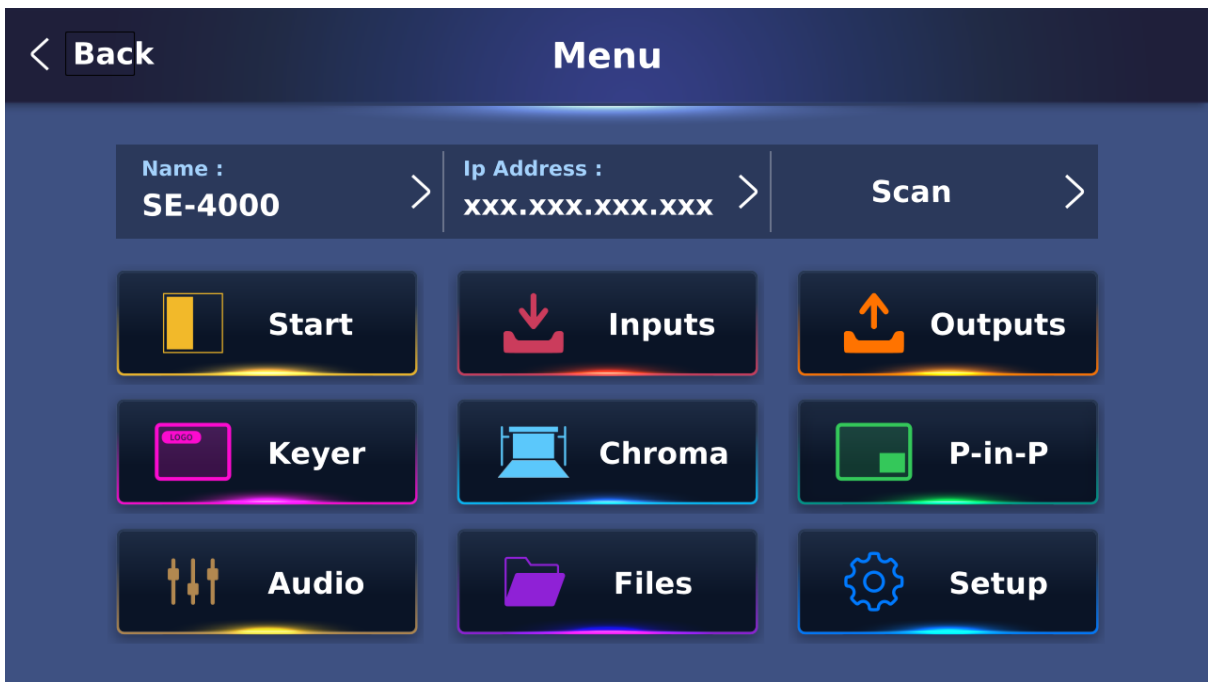

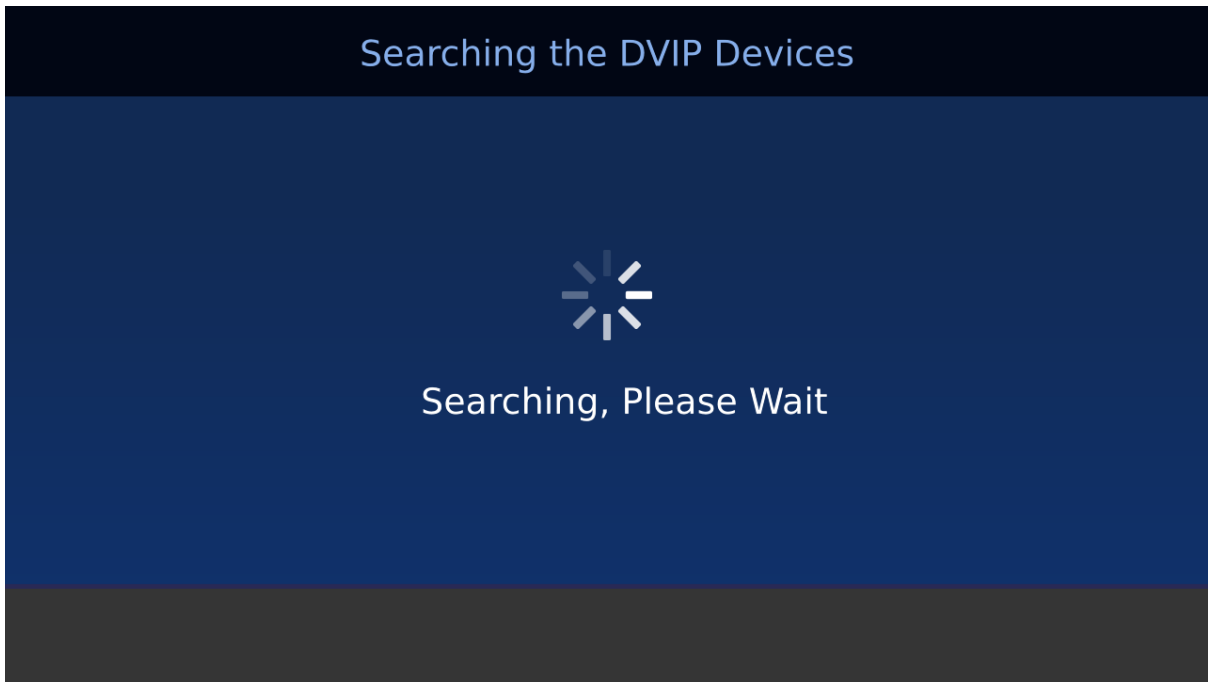

The control panel should detect one main unit named SE-4000. Select the detected device then tap **Apply** to establish connection.



You can start using the switcher after the control panel has been connected to the main unit successfully.

### Network Connection

Connect DVIP ports of the main unit and the control panel to a router. The router's IP address should be set to 192.168.100.1. See the manual for more information about using the router. Instructions on network setup of the switcher can be found in [Section 2.2](#).

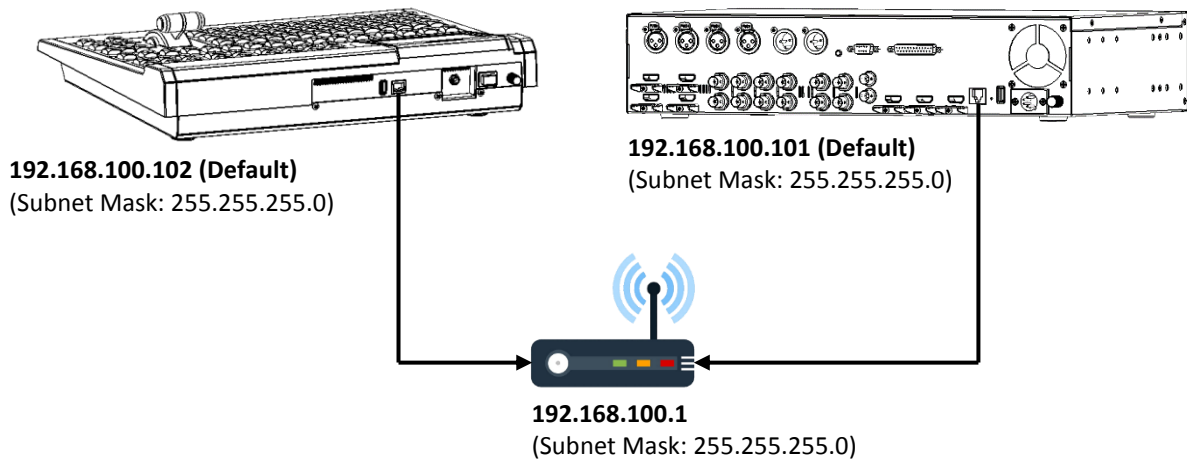

**Note: The main unit, the control panel and the router should be assigned IPs that are in the same network segment.**

After establishing network connection between the main unit and the control panel, simply turn on the respective power switches. After the switcher has been successfully booted up, you should see the GUI on the 5 inch touch screen as shown below. Tap the gear icon located at the top right corner to open the main menu.

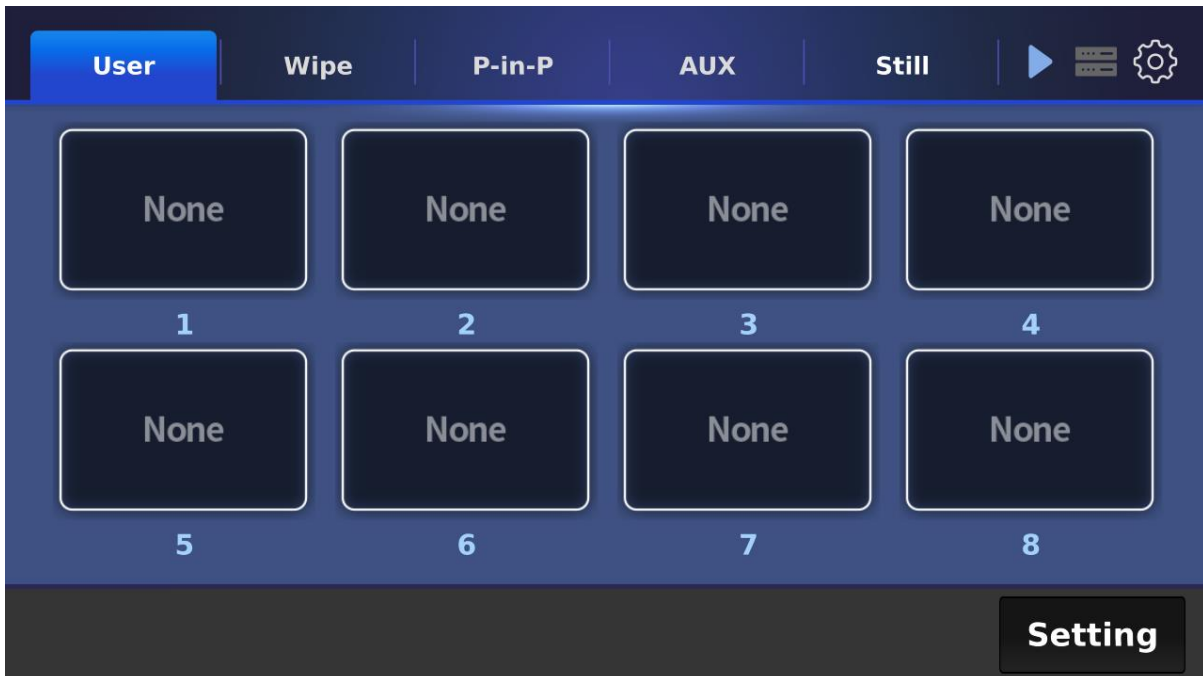

Tap **SCAN** on the main menu to search for available main units.

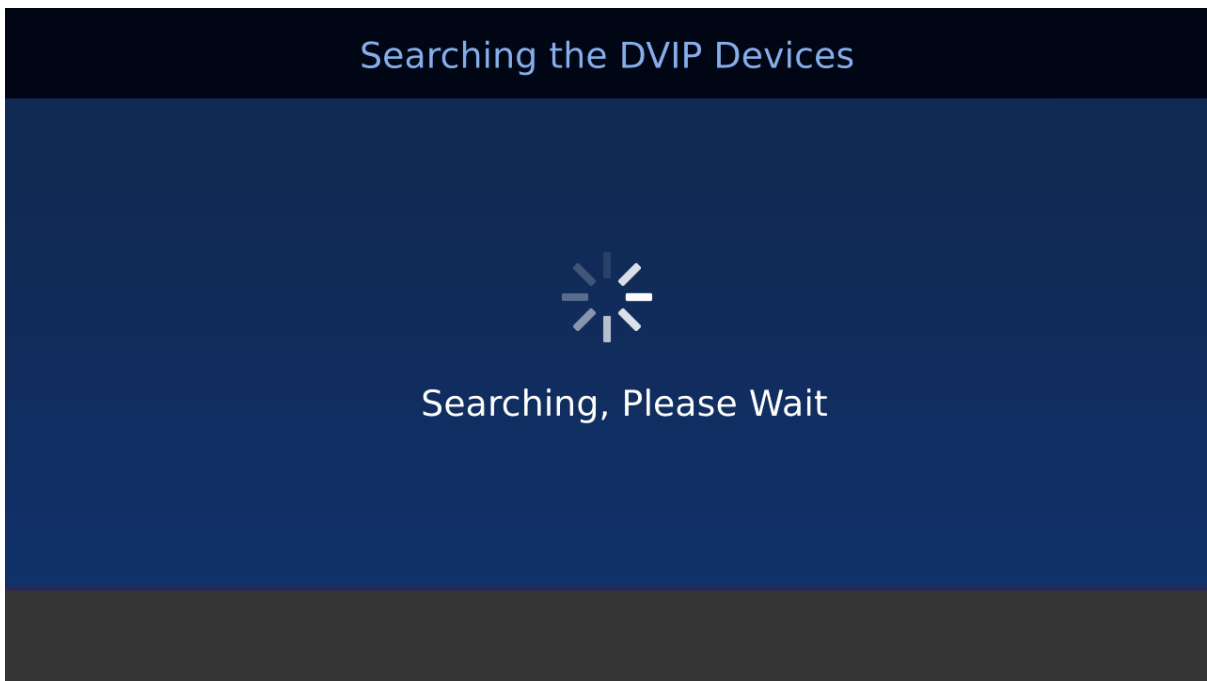
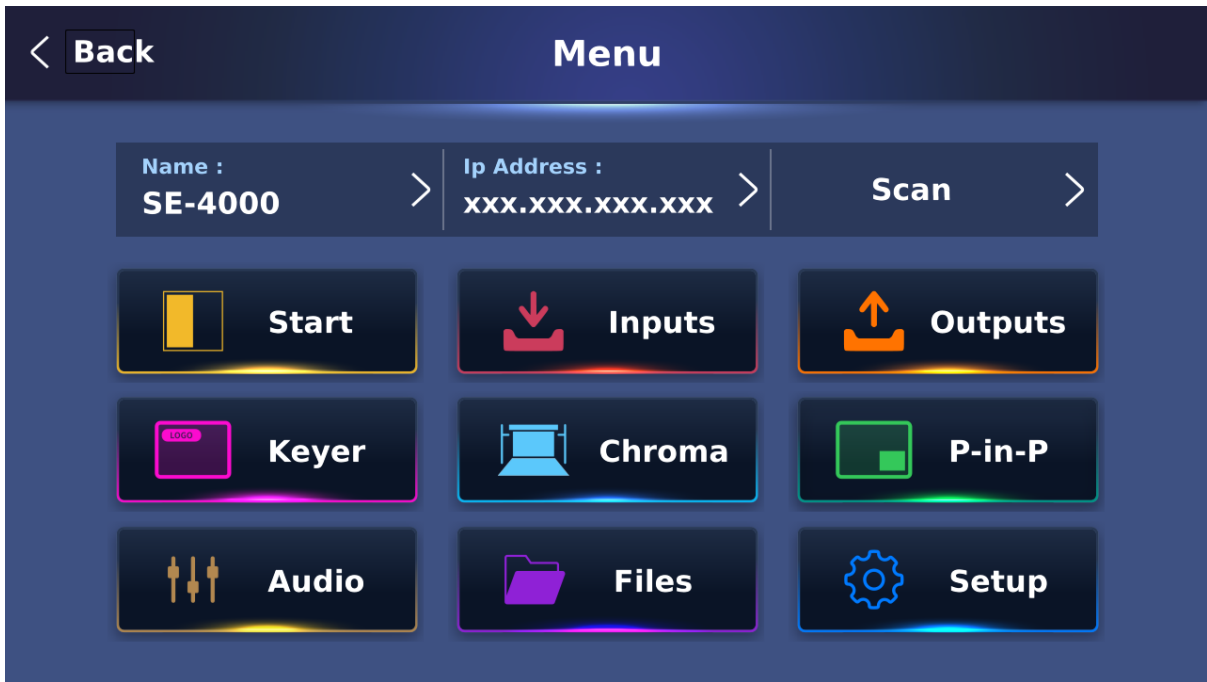

You may detect up to 6 SE-4000 main units. Select one device from the list then tap Apply to establish connection.

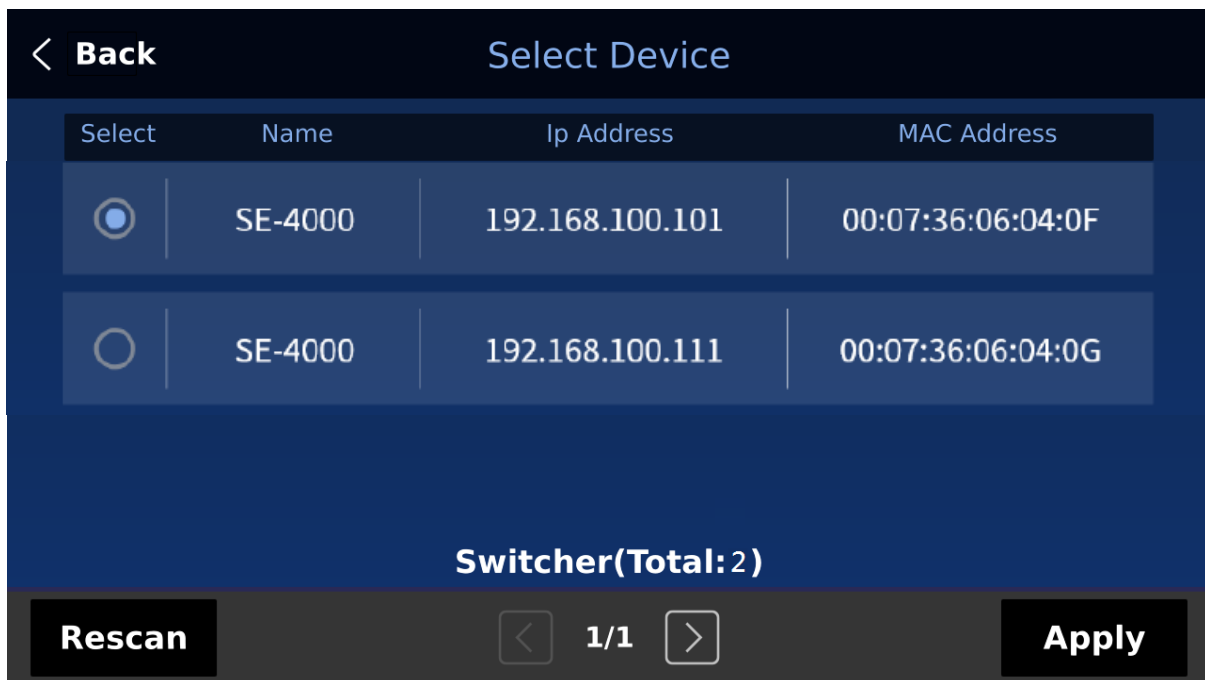

You can start using the switcher after the control panel has been connected to the selected main unit successfully.

### Connecting Video and Audio Input Devices

Connect cameras, computers and other video input devices to the video input connectors on the rear of the unit and connect an audio mixer to audio input connectors.

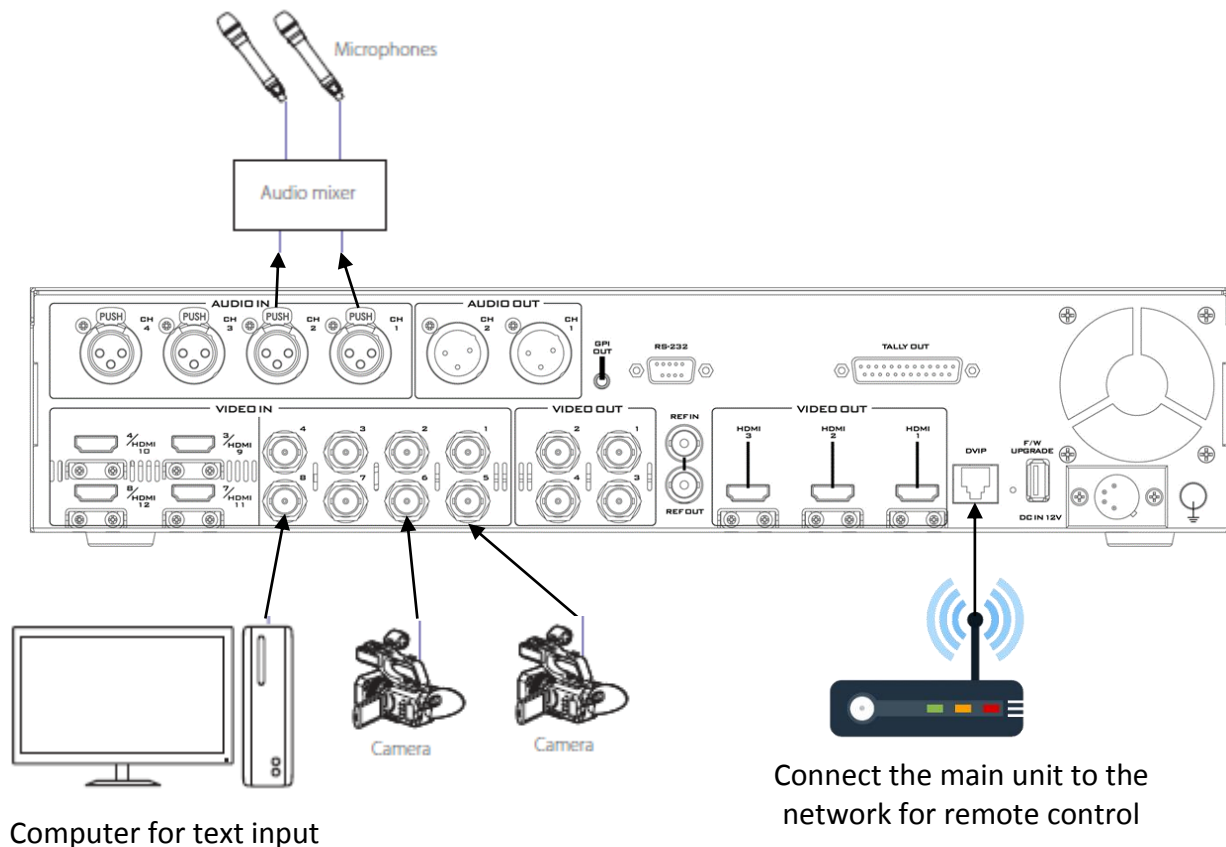

### When linking via tally connection

Connect the switcher's tally OUT port to a commercially available tally box. The tally pinout information can be found in [Appendix 1](#).

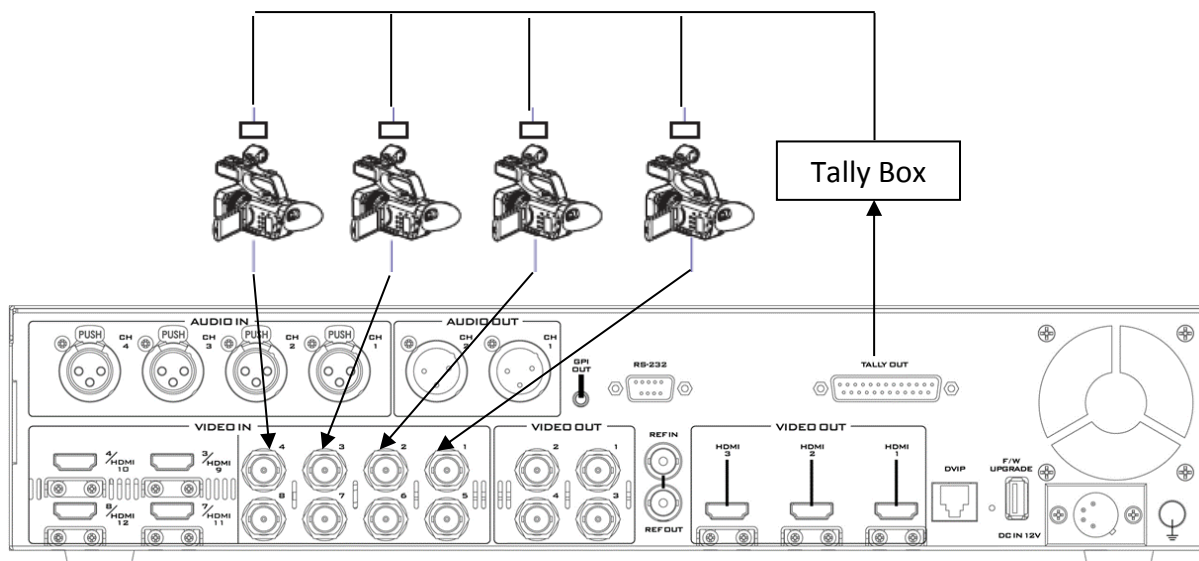

### Connecting Video and Audio Output Devices

Connect projectors, large displays and other video output devices to the video output ports on the rear of the main unit.

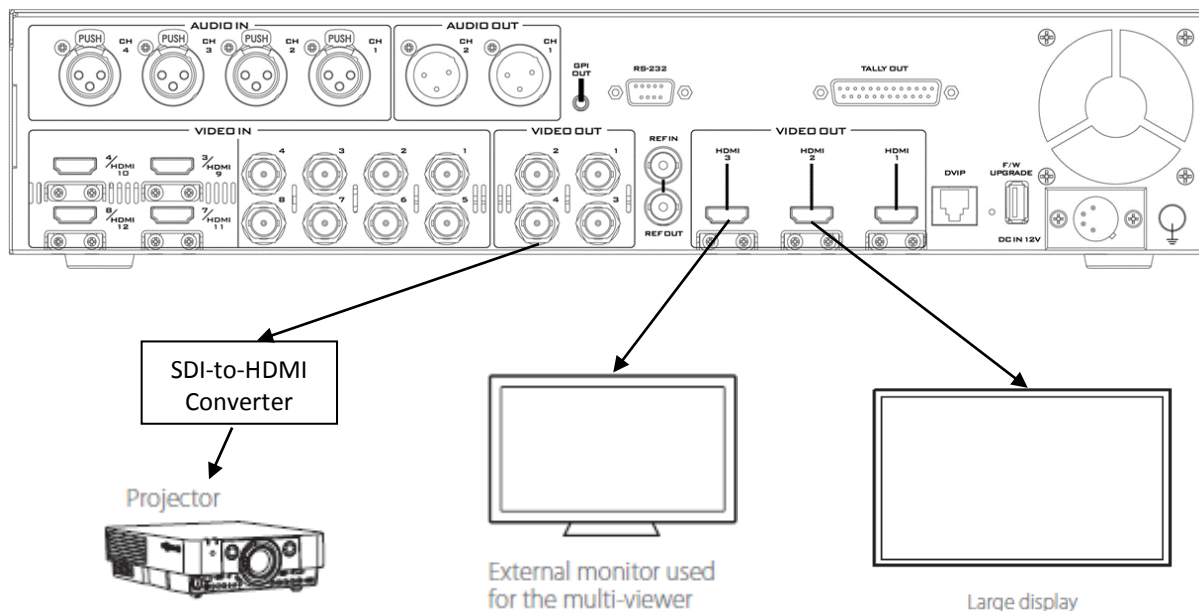



## 2.2 Network Setup

The SE-4000's main unit and control panel can be connected to the network via their DVIP ports. The available connection modes are fixed IP and DHCP which will be described in the next two sections.

### *Static IP Configuration*

When new from the factory the SE-4000's main unit and control panel will initially have static IP addresses of **192.168.100.101** and **192.168.100.102** respectively. The units can be directly connected to the network via a router using any standard RJ-45 Ethernet cables. Before connecting, first make sure that the router, the main unit and the control panel are assigned IPs that are **in the same network segment**. See the manual for more information about using the router.

**Note: Subnetting your network can be advanced to some, please consult your IT specialist for assistance if necessary.**

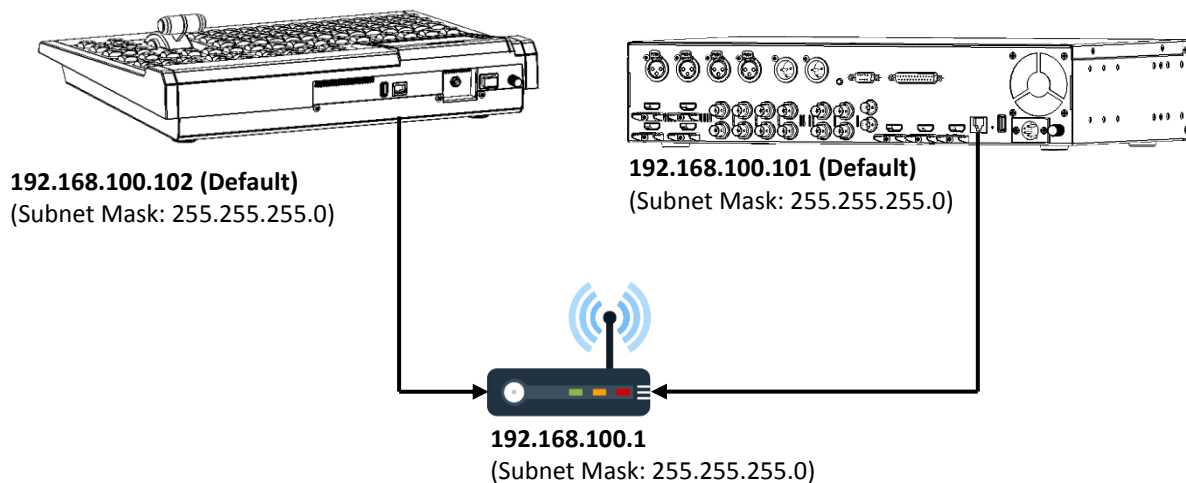

### *DHCP Mode*

Dynamic Host Configuration Protocol (DHCP) is a network management protocol used to automate the process of configuring devices on IP networks. Once configured to DHCP, the device will be assigned an IP address by a DHCP server upon connection to the network.

Follow the steps below to set the main unit and the control panel to DHCP:

1. Connect the control panel to the main unit according to instructions outlined in [Section 2.1](#).
2. Open the **SETUP** sub menu on the touch screen by pressing the SETUP button on the SE-4000's control panel.
3. Tap the **Network** tab to set the network options. Turn ON DHCP mode for the main unit as well as the control panel. Lastly, tap the Save button to save the changes.



- After you've been prompted that the save is successful, reboot the SE-4000 then physically connect the main unit and the control panel to the network or a router to receive IP addresses assigned automatically by a DHCP server.

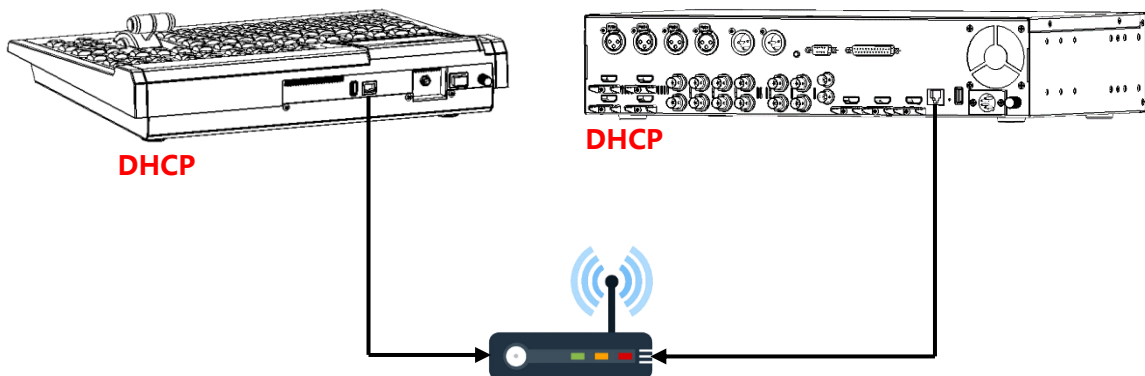

### **Fallback IP**

The Fallback IP is an IP address that a device will use when it fails to get an IP address from a DHCP server within 30 seconds. The following are fallback IPs of the main unit and the control panel:

Main unit: 192.168.100.30

Control panel: 192.168.100.31

In order to allow the DHCP server to reassign IP addresses to devices using the fallback IPs, you will have to reboot these devices. In our case, they are the main unit and the control panel.

Please note that if you try to use DHCP to establish direct connection between the main unit and the control panel, they will use their fallback IPs to connect.

## 2.3 Multi View

The SE-4000 Multi-view output can be supplied from the HDMI or SDI outputs, see [Chapter 5 \(5.6\)](#) for configuring the outputs. The Multi view shows monitoring images for **Preview** (PVW), **Program** (PGM) and **Inputs 1~8**. The Multi view can also show **audio level bars** overlaid on the Program image. This confirms that the analogue XLR audio input is being received and embedded to the selected Program output(s).

The SE-4000 Multi-view supplied from the SDI/HDMI connection(s) on the rear panel can be available across multiple SDI/HDMI monitors (not supplied). Since a variety of multi-image layouts is available, these SDI/HDMI outputs can be used to monitor video and audio in a number of different configurations. The layout of the multi-view can also be changed. The sources can be swapped around using the cross point section of the Inputs menu. For each setup, embedded audio level indication is available on the Preview and Program windows.

There are six different multi-view layouts available on the SE-4000. See [Multiviewer](#) in [Section 5.6](#) for setup instructions.

**Note: A Red tally indication box** will be shown around the sources selected for Program OUT and these selected sources should be displayed at the switcher's selected Program output(s). **A Green tally indication box** is shown around the sources selected for Preview. These are the next image sources to be mixed to, wiped in or cut to the Program OUT depending on the user's preference.

## Chapter 3 Device Initialization

After the SE-4000 is booted up, there are initial settings that you should configure on the GUI. These initial settings will be discussed in this chapter.

You should see the GUI shown below on the touch screen.

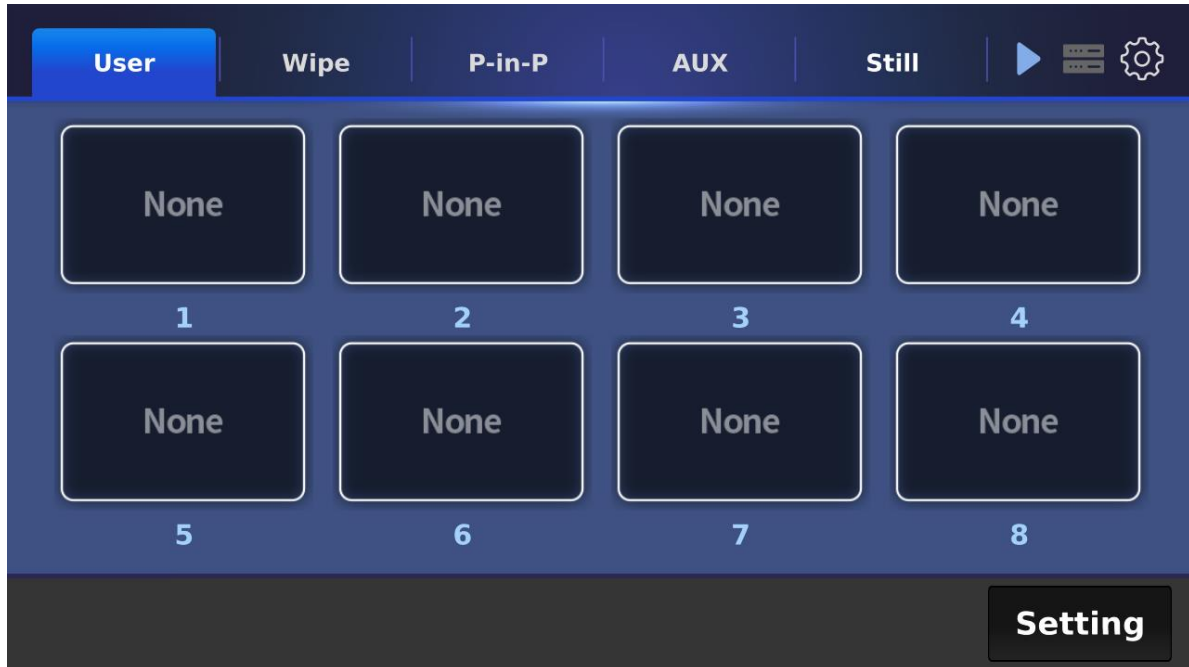

Various initial settings are listed as follows:

- User memory
- Wipe effects
- Picture in picture
- Audio
- AUX
- Still pictures
- Keyer
- Cross Point

Tap the gear icon at the top right corner to open the main menu of the [Graphical User Interface](#).

### 3.1 User Memory

The user memory allows you to load pre-saved settings configured for a specific scenario. Simply tap one of the buttons to immediately load the settings. The button icons should allow you to identify the settings saved therein.

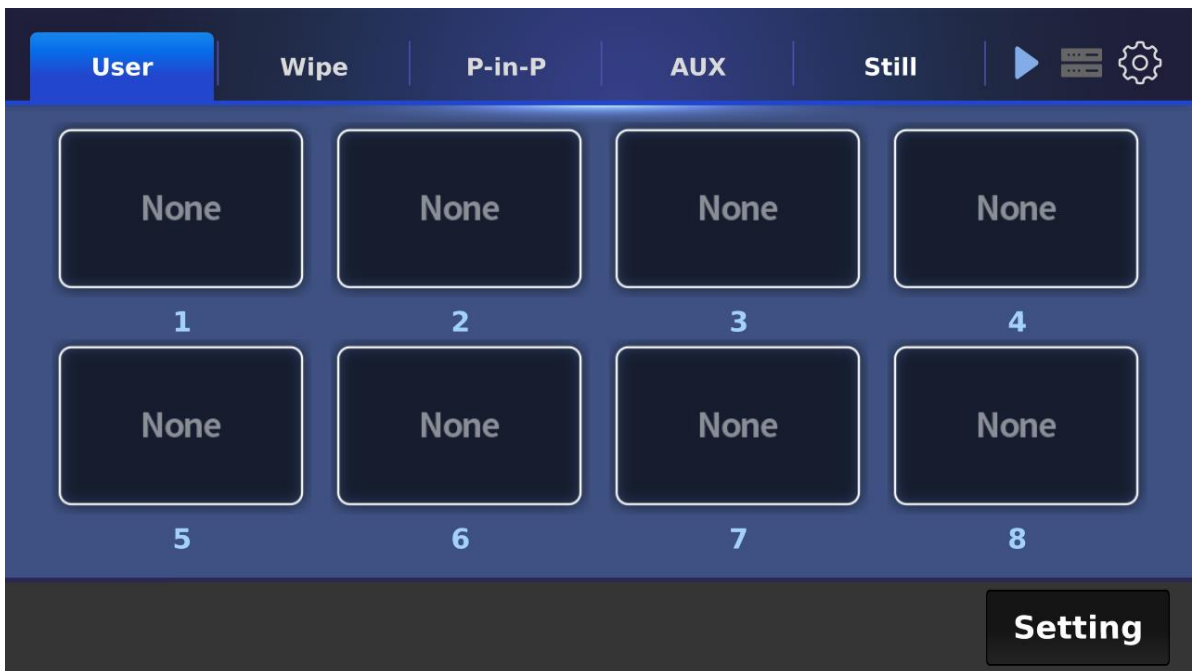

Tap the **Setting** button to change the button icons or swap the settings between the selected user memory slots.

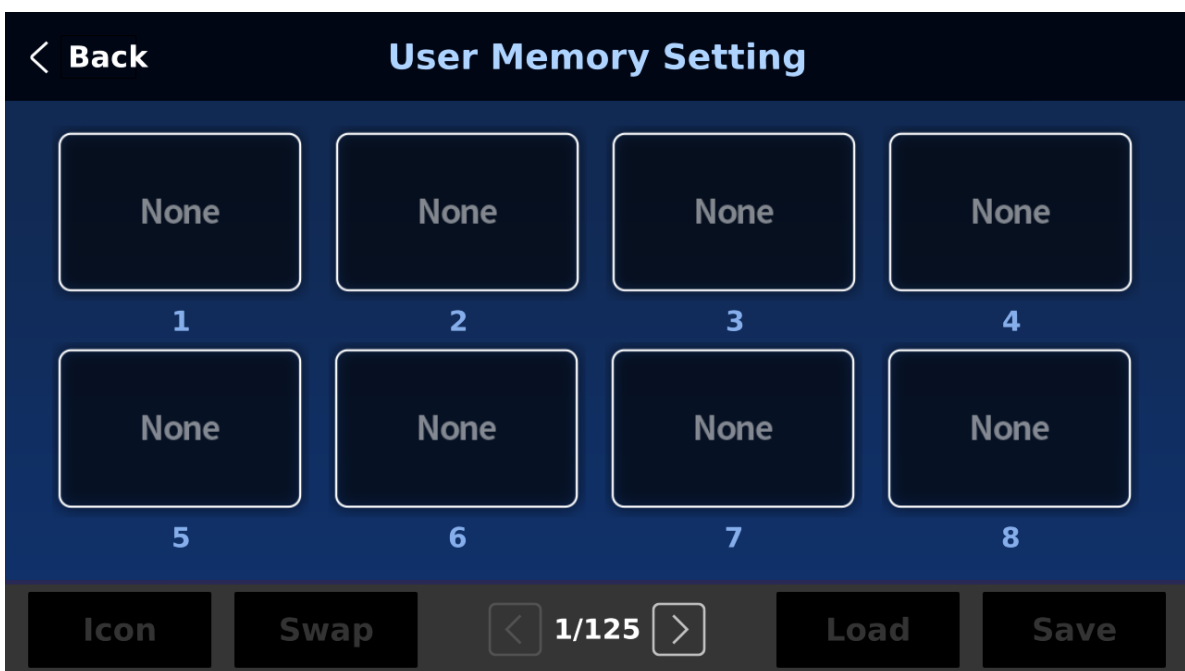

**Icon:** Tap to select an icon for the selected user memory slot.

**Swap:** Follow the steps outlined below to swap the contents of two user memory slots.

1. First tap a user memory slot.
2. Tap the Swap button.
3. Tap another user memory slot.
4. Lastly confirm the swap.

**Load:** Tap to load the settings in the selected user memory slot.

**Save:** Tap to save the current device settings in the selected user memory slot.

### 3.2 WIPE Effects

Open the Wipe page to select a wipe effect. Tap the REV button to reverse the default wipe direction.



Tap the Setting button to configure the wipe borders. Enable the border first then adjust its hue, softness and width.

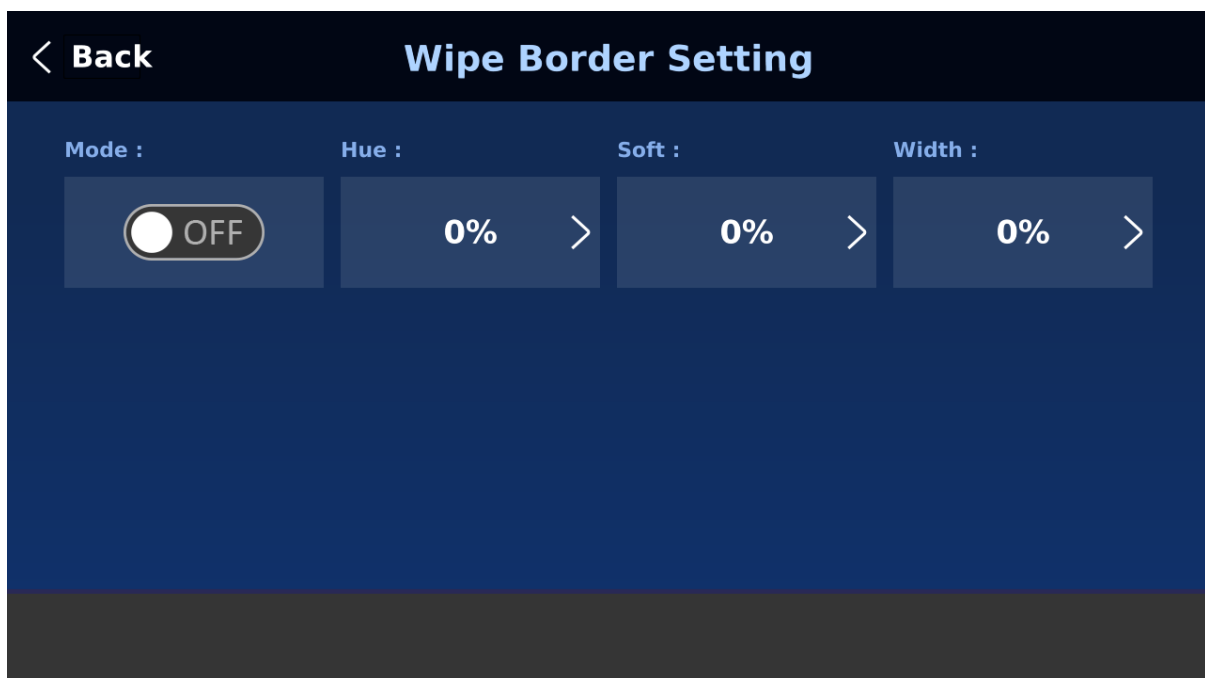

### 3.3 PIP

In the P-in-P tab, you will be allowed to select how you would like to position the PIP window on the Preview and Program screens. Tap the **PIP Icon** button to select an icon for the PIP window options. To configure the PIP window, tap the **Setting** button.



**PIP Icon**

Tap the Edit button to select an icon. To restore the defaults, simply tap the Reset button.

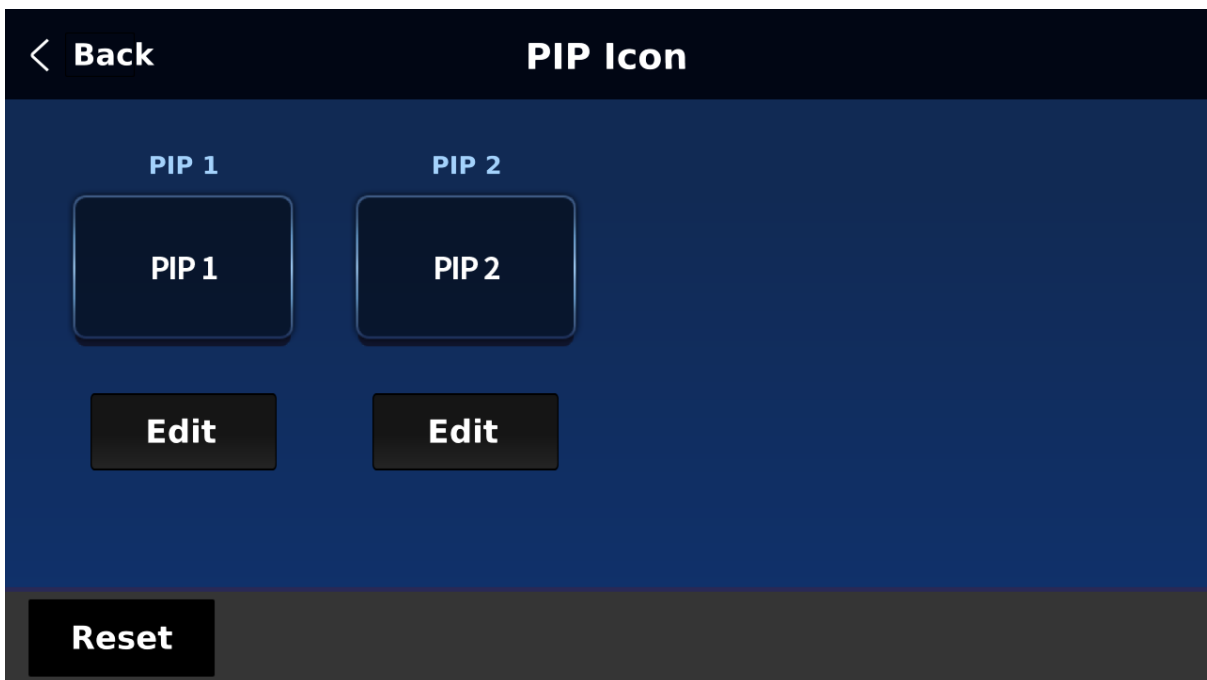

**PIP Setting**

On the PIP setting page, you can select a video source for the PIP window and set the window position and size.

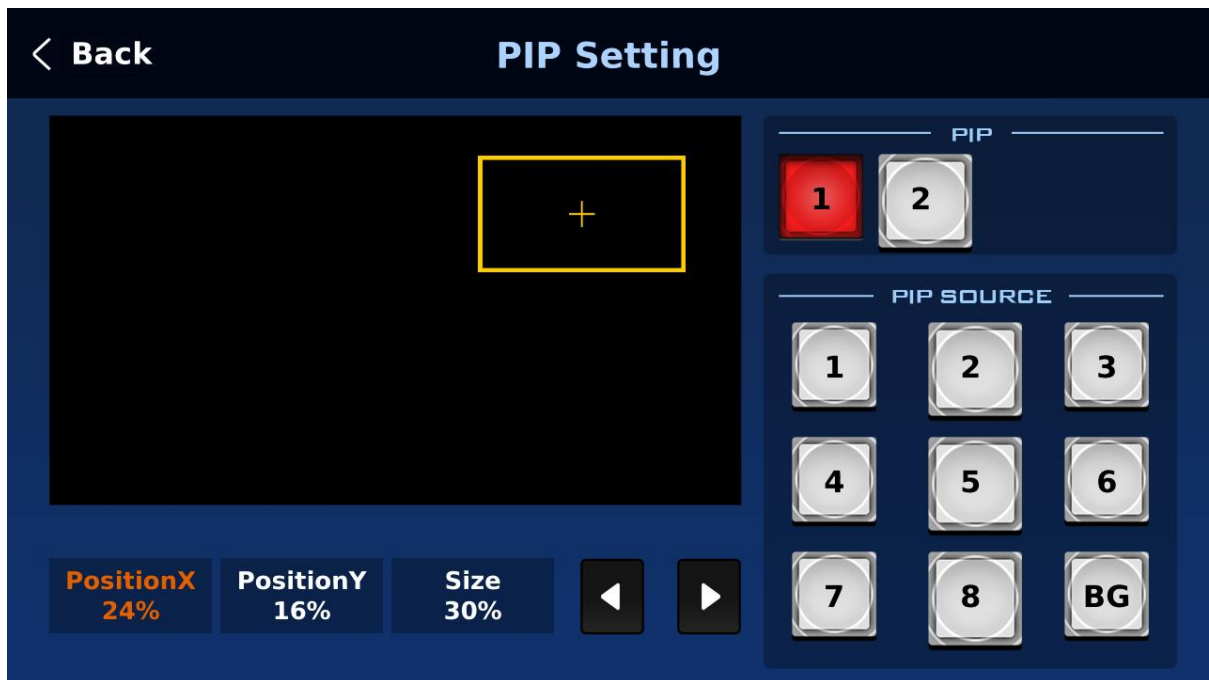

### 3.4 AUX

In AUX tab, you will be allowed to assign a video source for the output ports. See all available options in the *Source* pane.



### 3.5 Still

On the **Still** page, you can assign different still images to the input channels. Follow the steps below to make the selection:

1. First select an input channel then a still image.
2. Tap the **Load** button to confirm the selection.
3. Lastly tap **Save** to save the settings.



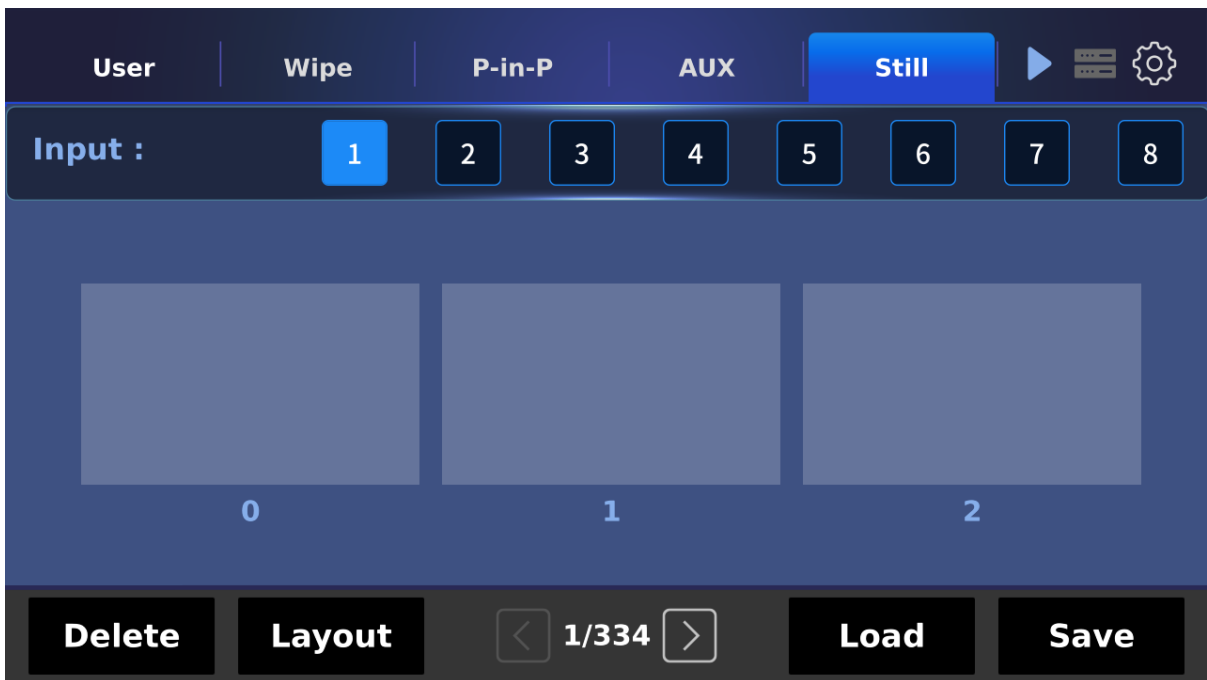

Delete and Layout buttons are described below:

**Delete:** Tap to delete the selected still image.

**Layout:** Tap to select the still image pane layout. You can either display three (1 x 3) or eight (2 x 4) thumbnails at the same time.



### 3.6 Keyer

On the Keyer page, you can configure Keyers 1 – 4 and DSK 1/2. The available keyer options are chroma, luma, linear and none (full).

The CK Auto button performs auto chromakeying, which can be activated for chroma keyers.

For luma keyers, the Invert button allows you to select the background color to be keyed. When the Invert button is disabled, the luma keyer removes the black background; when the Invert button is enabled, the luma keyer removes the white background.

DSK 1/2 are usually set to **Linear** keying mode which is chosen for professional graphic design.



### **Adjust**

Tap the Adjust button to set the **Opacity**, **Lift** and **Gain** parameters for the luma keyer.

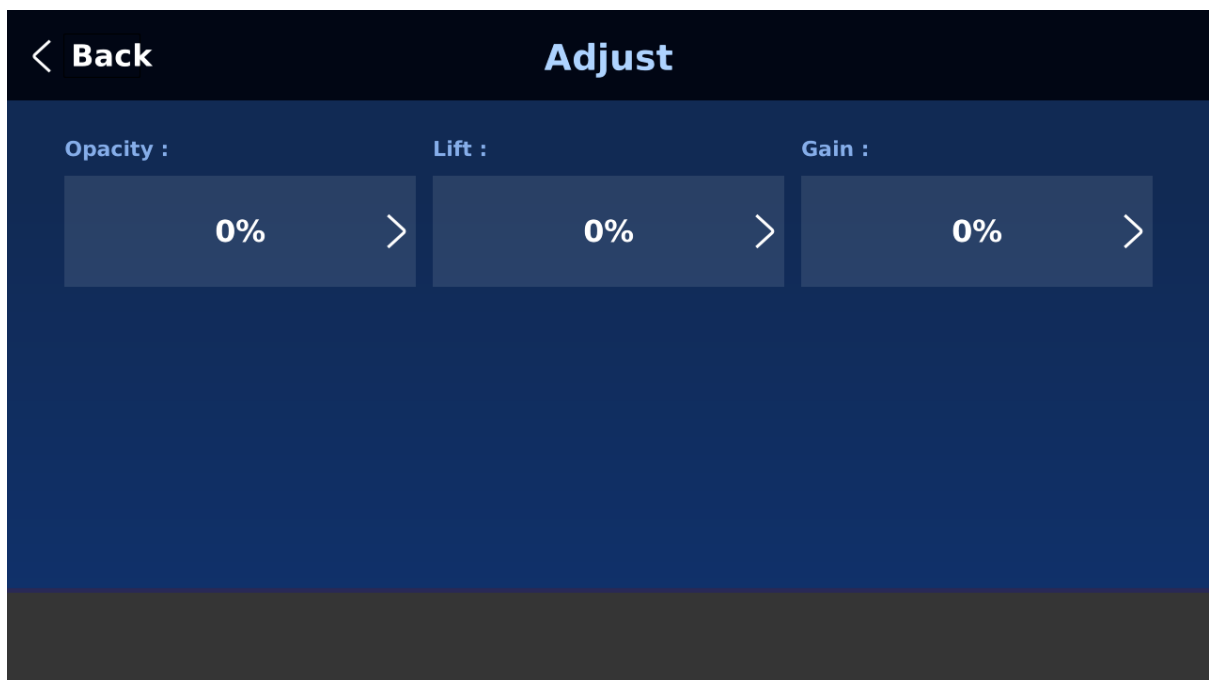

### 3.7 Cross Point

The Cross Point function allows the user to shuffle contents of Inputs 1 – 8 without changing physical connections at the back of the machine.

First select an input channel then tap Video XPT or Audio XPT to set the respective sources.



In Audio XPT, if "FOL." is selected, the audio will enter Audio follow Video mode, i.e. playback of the audio of the output video **without audio output delay**. If "EXT." is selected, the external audio, i.e. audio from **AUDIO IN** port, will be played.



In Audio Setting, you will be allowed to adjust audio gain and delay.

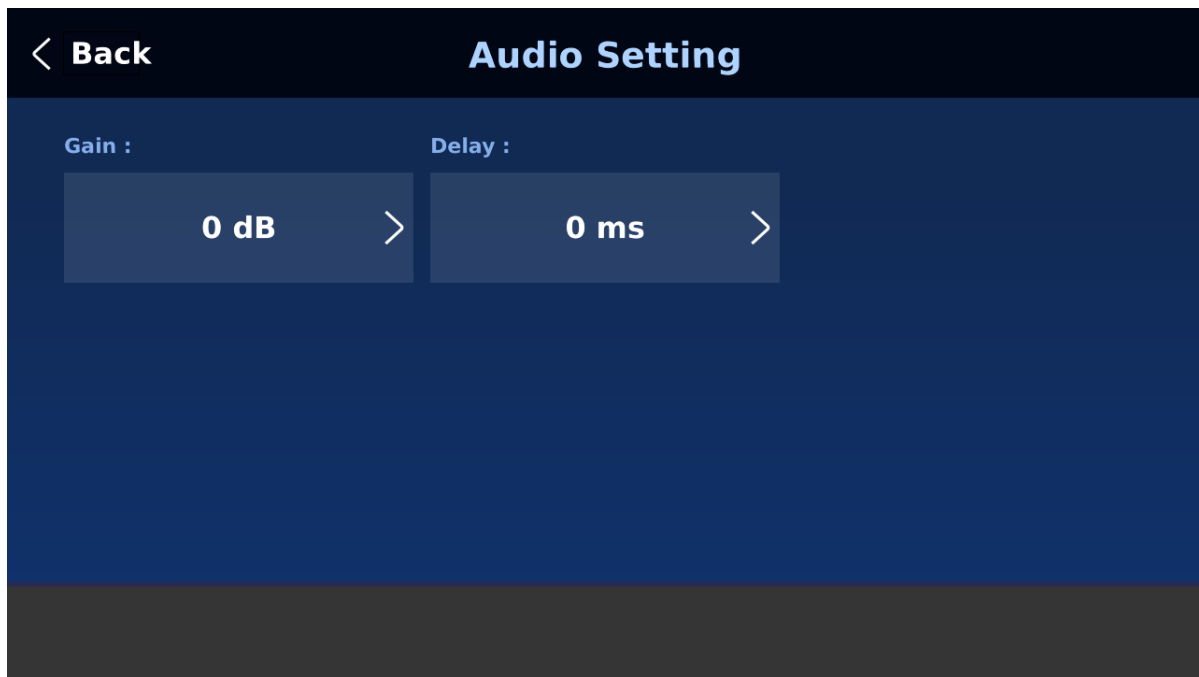

### 3.8 Audio

In Audio tab, you will be allowed to select the audio source for the input video channels. You can either use the video channel's own audio or a mixed audio from selected video channels.



By default, all video channels will be enabled in the Follow frame, which means that all of them will use its own audio.

To assign the mixed audio from the Mixer frame to the video channels, first click the desired channel numbers for the mixer then disable the video channels that you would like to assign

the mixed audio to. For example, in the diagram below, channel 6 will use the mixer audio which is a combination of audio sources of channels 1, 4 and 7.

**Note:** In addition to audios of the input video channels, you can also mixed external audio sources by enabling the EXT button in the Mixer.

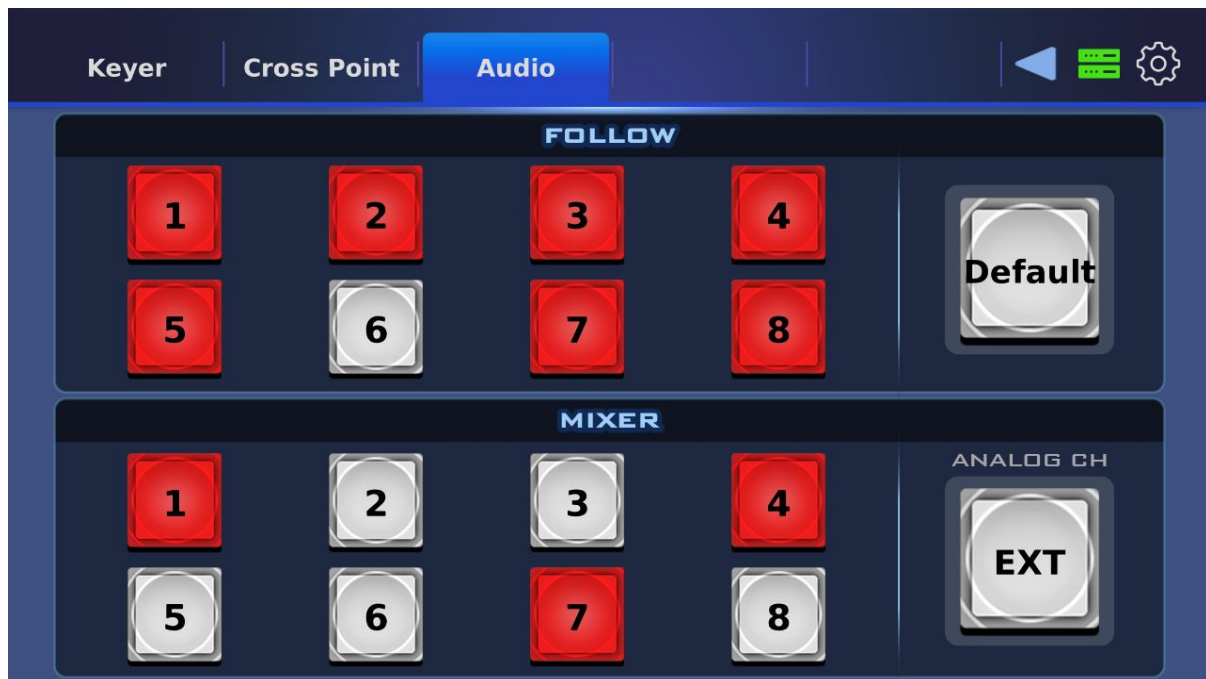

## Chapter 4 Software Setup for Switcher

The **Switcher Image Import/Export software** allows the user to import still images, animated clips, still logos, animated logos and custom user settings to the SE-4000 from a laptop/PC. To use the Switcher Image Import/Export software, you should connect the control panel to the main unit using the network method. An example connection is illustrated in the diagram below:

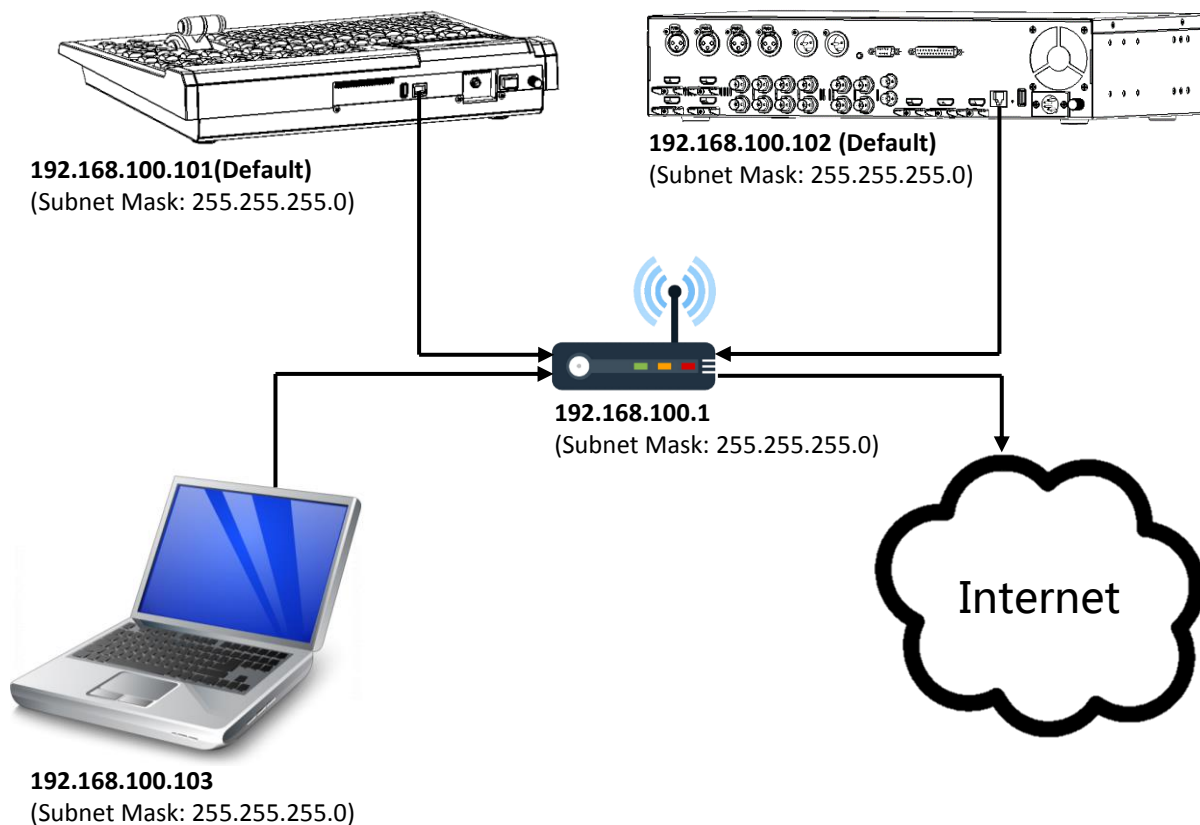

Please first download the software to your PC or laptop from the product page (<https://www.datavideo.com/tw/product/SE-4000>) before using this feature.

On the PC to which the software is downloaded, unzip the downloaded file then in the unzipped folder, double click the software icon to open the program.

The **Switcher Image Import/Export software** has a built-in IP finder, which is designed for PC with multiple Ethernet cards or DHCP network environment. Upon launch of the software, you will be prompted to select one Ethernet Interface Card. **Please note that the IP finder can only find devices connected to the same network as the PC.**

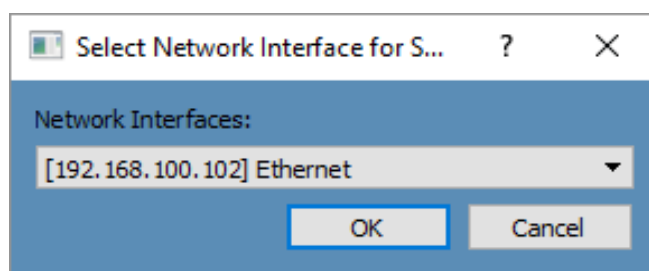

Once selected, click **OK** to start the scanning process.

**Note: Please make sure that the selected interface card is in the same network segment as the SE-4000.**

The software should connect with the switcher's main unit over the IP set up in [Section 2.2](#). If the connection is successfully established, on the software user interface, the **Connect Status** will show "**Connected**" (will display **Not Connected** if disconnected).

Brief descriptions of buttons on the **MENU SELECT** pane are outlined as follows:

- **Home:** Interface main page showing connection status and transition time settings.
- **User:** User memory import
- **Still:** Still image import
- **Clip:** Clip file import
- **Logo:** Still logo import
- **Ani-Logo:** Animated logo import
- **Setup:** Software settings

## 4.1 Home

As soon as the program is opened, you will see the interface home as shown in the diagram below. The function items are described as follows:

- **Connect Status:** Shows "**Connected**" if the program establishes connection with the switcher successfully; shows "**Not Connected**" otherwise.
- **ME Trans:** Sets MIX EFFECT transition time in frames. See also GUI Menu → [Start](#) → **M/E**.
- **DSK Trans:** Sets DSK transition time in frames. See also GUI Menu → [Start](#) → **DSK**.
- **FTB Trans:** Sets Fade-to-Black transition time in frames. See also GUI Menu → [Start](#) → **FTB**.



## 4.2 User

Click the **User** button to view all the .mem files saved on the switcher.

To import .mem files from your PC, click “**User**” then enter a memory location. Click “**Import User**” to browse your hard drive and select the user memory file that you would like to import.

See section 5.8, [User Mems](#), for more details.

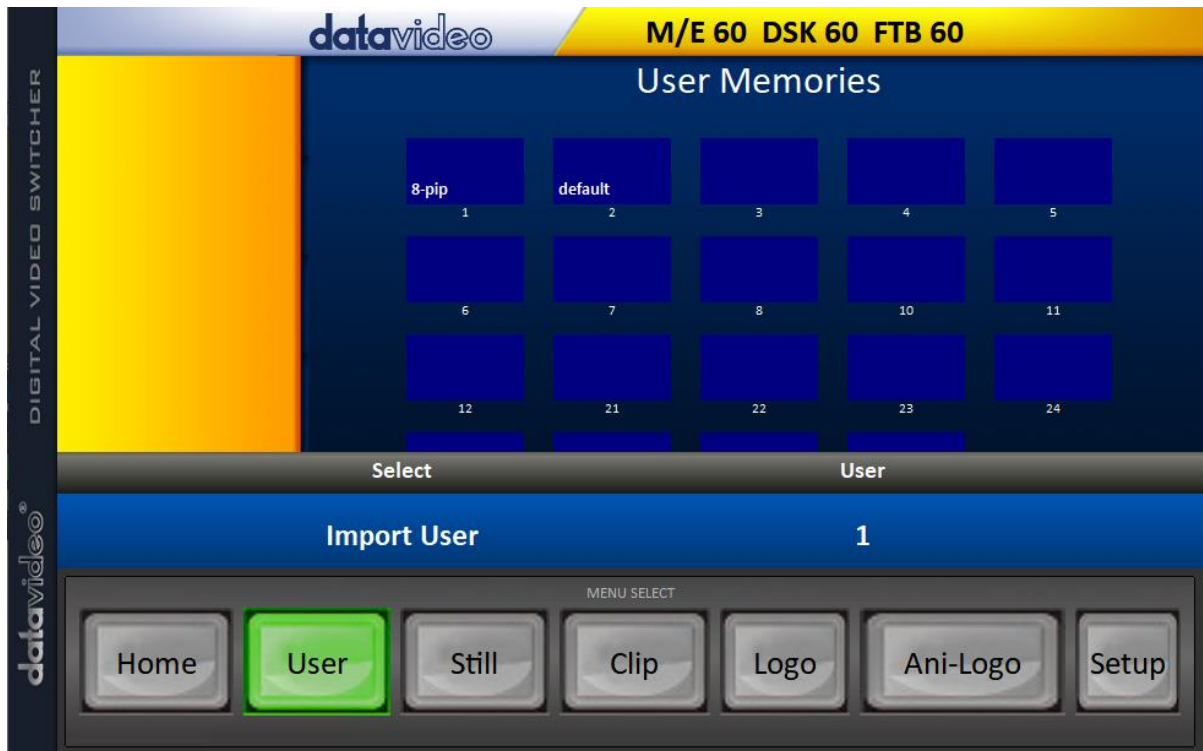

## 4.3 Still

Click the **Still** button to view all the still images saved on the switcher.

To import still image files from your PC, click “**Still**” then enter a memory location. Click “**Import Still**” to browse your hard drive and select the image file that you would like to import.

See section 5.8, [Still](#), and section 6.3, [Managing Still Pictures](#), for more details.





#### 4.4 Clip

Click the **Clip** button to view all the clips saved on the switcher.

To import clip files from your PC, click “**Clip**” then enter a memory location. Click “**Import Clip**” to browse your hard drive and select the clip file that you would like to import.

Please note that the Stinger transition effect is currently unavailable but if you are interested, you may refer to section 5.8 [Stinger](#) for more details.



## 4.5 Logo

Click the **Logo** button to view all the still logo images saved on the switcher.

To import still logo image files from your PC, click “**Logo**” then enter a memory location. Click “**Import Logo**” to browse your hard drive and select the logo image file that you would like to import.

See section 5.8, [Logo](#), and section 6.4, [Enabling Still Logo](#), for more details.



## 4.6 Ani-Logo

Click the **Ani-Logo** button to view all the animated logos saved on the switcher.

To import animated logo files from your PC, click “**Ani-Logo**” then enter a memory location. Click “**Import Ani-Logo**” to browse your hard drive and select the animated logo that you would like to import.

See section 5.8, [Ani-Logo](#), and section 6.5, [Enabling Logo Animation](#), for more details.

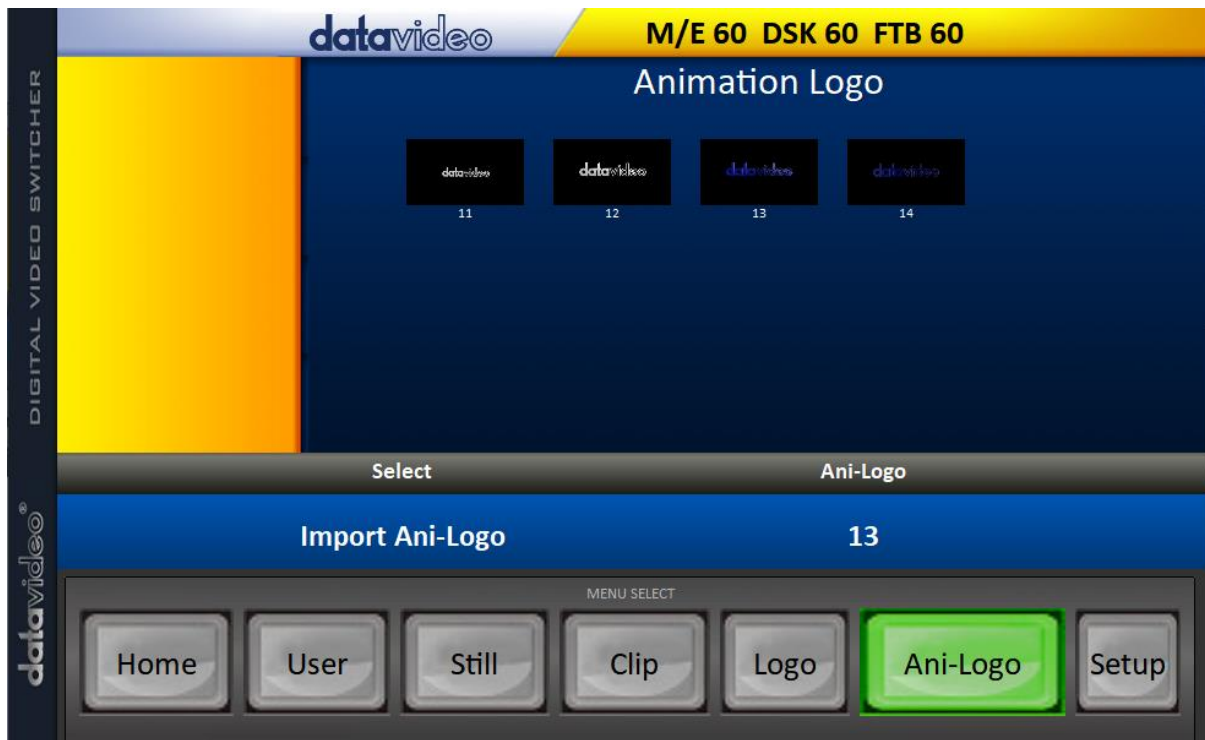

## 4.7 Setup

On the **Setup** page, you will be able to view the software version, network connect status, firmware version installed and the available space on the switcher.

The **Setup** page allows you to reset the software to its defaults, and change the interface language. The available languages are **English**, **Traditional Chinese**, and **Simplified Chinese**. Click **Save Setup** to apply the new settings.

The **Target IP Address** is the IP address of the switcher that you would like to connect. Enter the IP then click **SCAN** to connect to the switcher.

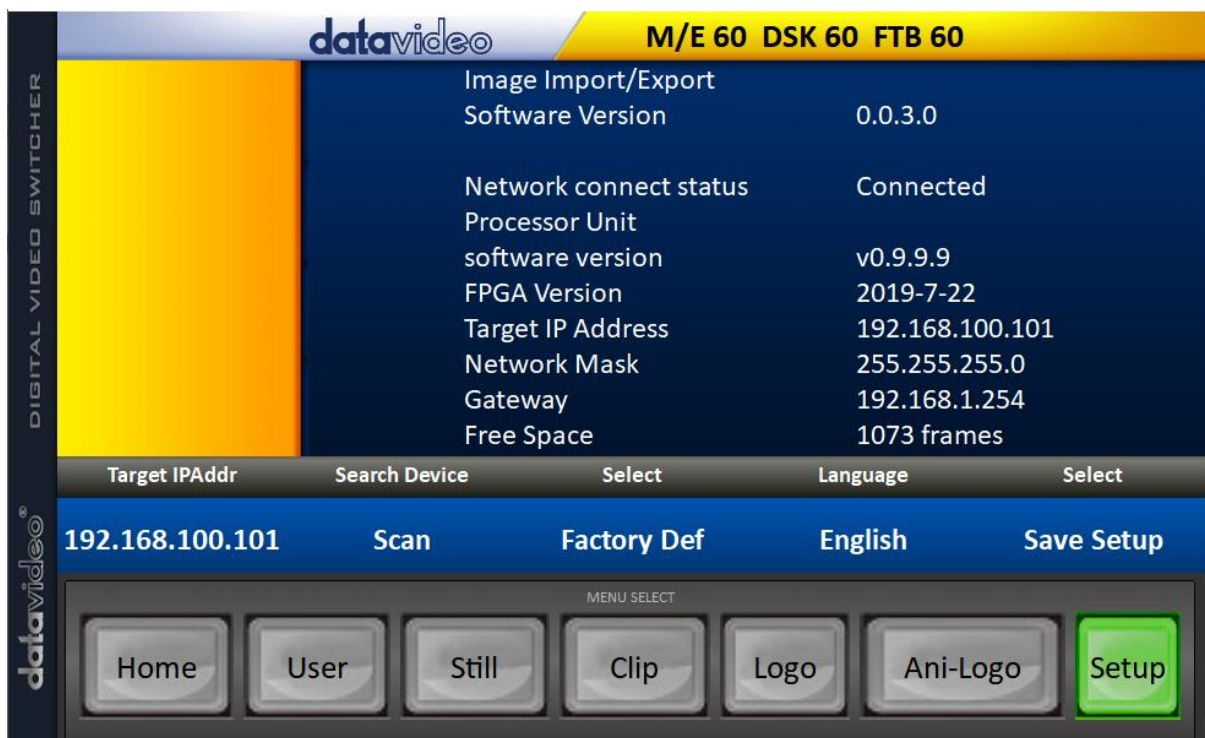

## Chapter 5 Graphical User Interface



The switcher’s GUI menu allows the user to perform several configurations of image effects, such as Picture-in-Picture, chroma key, subtitle overlay, transition effects, still pictures, etc. The user can also configure the I/O by selecting different input and output combinations. In addition, in the setup menu, the user is allowed to adjust the keyboard brightness, set the menu language, reset the device, customize network settings and upgrade the firmware.

The GUI control buttons are designed for opening the GUI on the built-in 5 inch monitor and navigating through the sub menus. Press the HOME button to open the Home Menu page or the sub menu buttons to directly access the corresponding sub menus.

**Please note that after pressing the power button located at the rear of the control panel while the machine is still running, you will be prompted on the 5 inch touch screen to confirm the shutdown. Select YES if you would like to shut down the machine and the last device settings will be automatically saved before it’s turned off.**

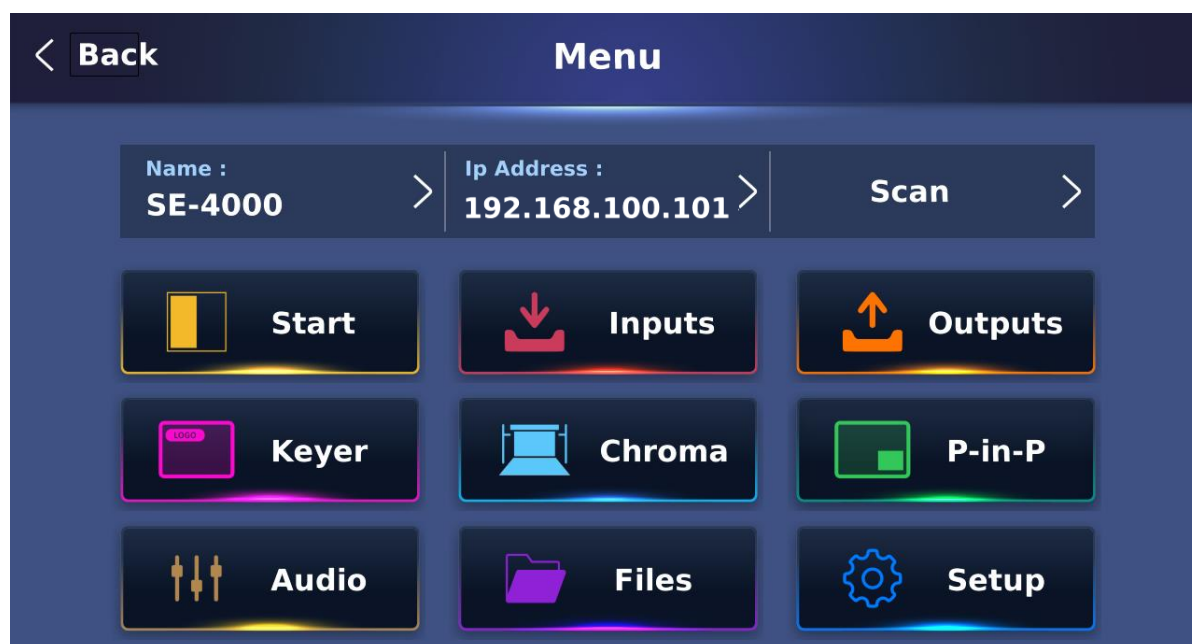

Main	Sub	Options and Parameters	
Start	Transition (Duration)	M/E	Mix Effect (0 - 999 Default: 0)
		DSK	Downstream Key (0 - 999 Default: 0)
		FTB	Fade-to-Black (0 - 999 Default: 0)
	Type	Mix	
		Wipe	
		Clip	Default
	Matte	Luma	Background Matte Luma (0 – 100% Default: 0%)
		Sat	Background Matte Saturation (0 – 100% Default: 0%)
		Hue	Background Matte Hue (0 – 359 Default: 0)

Main	Sub	Options and Parameters		
	Wipe Effects	Wipe	Wipe Effect Presets (1 - 32 Default: 1)	
		Soft	Border Softness (0 - 100% Default: 0%)	
		Width	Border Width (0 - 100% Default: 0%)	
	Border	Luma	Border Color Luma (0 - 100% Default: 0%)	
		Sat	Border Color Saturation (0 - 100% Default: 0%)	
		Hue	Border Color Hue (0 - 359 Default: 0)	
	Position	X	Horizontal Position (-100 - 100% Default: 0%)	
Y		Vertical Position (-100 - 100% Default: 0%)		
Keyer	Keyer	Key 1 Key 2 Key 3 Key 4 DSK 1 DSK 2	Keyer Selection (Default: Key 1)	
		Fine / Normal	Fine: High keying quality Normal: Original keying quality	
	Keyer Ctrl	Mode	Linear Luma Chroma Full	Type of Keyer (Default: Linear)
		Source Mode	Self Split P-in-P	Self: One input keyer (Default) Split: Dual input keyer P-in-P: Apply the keying effect to the PIP window.
		Opac		Parameter for transparency of the overall foreground key image, ranging from 0% to 100% (Default: 0%).
		Lift		Parameter for dark/black areas of the overall foreground key image, ranging from -100% to +100% (Default: 0%).
		Gain		Parameter for light/white areas of the overall foreground key image, ranging from 0 to 16.8 (Default: 0).
		Invert		OFF: Luma key removes black background by default ON: Luma key removes white background after <b>INVERT</b> is turned <b>ON</b> .
	Key Source	Key Source		Select key source from the list below: Bars Matte Input 1 Input 2 Input 3 Input 4 Input 5 Input 6 Input 7 Input 8 Black (Default)
		Fill Source		Select fill source from the list below: Bars Matte

Main	Sub	Options and Parameters		
			Input 1 Input 2 Input 3 Input 4 Input 5 Input 6 Input 7 Input 8 Black (Default)	
		Mask	Left	Left sets the left edge of the keyer mask (0 – 100%; Default: 0%).
			Right	Right sets the right edge of the keyer mask (0 – 100%; Default: 0%).
			Top	Top sets the top edge of the keyer mask (0 – 100%; Default: 0%).
	Bottom	Bottom sets the bottom edge of the keyer mask (0 – 100%; Default: 0%).		
Chroma	Keyer	Key 1 Key 2 Key 3 Key 4	Keyer Selection (Default: Key 1)	
		Quality	Fine: High image quality Normal: Original image quality	
	Key Source	Bars Matte Input 8 Input 7 Input 6 Input 5 Input 4 Input 3 Input 2 Input 1 Black	Key Source Selections (Default: Black)	
		Key Tie	Mode	ON/OFF
			Background Image	Input 1 – 8 Off
		CK Setup	CK Auto	Calculation of the best Hue & Luma values for the current Keyer source
			Hue	Parameter for color of the chroma key, ranging from 0 to 359 (Default: 0).
	Luma		Parameter for luma of the chroma key, ranging from 0 to 100% (Default: 0%).	
	K Range		Setting the range of colors that match the background color to be keyed, ranging from 0 to 359 (Default: 0).	
	K Fgnd		Adjusts the performance of the chroma key in dark or black areas, ranging from -100% to 100% (Default: 0%).	
	K Bgnd	Adjusts the performance of the chroma key in light or white areas, ranging from K Fgnd value (min = 0) to 100% (Default: 0%).		

Main	Sub	Options and Parameters		
		Hi-Light	Boosts the foreground key in high luminance area, ranging from 0 to 100% (Default: 0%).	
		Lo-Light	Boosts the foreground key in low luminance area, ranging from 0 to 100% (Default: 0%).	
		Bg-Supp	Bg-Supp turns ON/OFF background suppress (Default: OFF).	
		Left	Trims the left edge of the key object (0 - 100% Default: 0%).	
		Right	Trims the right edge of the key object (0 - 100% Default: 0%).	
		Soft	Distinctiveness of key edge (0 - 100% Default: 0%)	
	Mask	Left	Left sets the left edge of the keyer mask (Default: 0%).	
		Right	Right sets the right edge of the keyer mask (Default: 0%).	
		Top	Top sets the top edge of the keyer mask (Default: 0%).	
		Bottom	Bottom sets the bottom edge of the keyer mask (Default: 0%).	
P-in-P	P-in-P	Source	Selection of PIP windows Key 1 Key 2 Key 3 Key 4 (Default)	
		Quality	Normal Fine	
	Position	X	Horizontal PIP Position (-100 - 100% Default: 0%)	
		Y	Vertical PIP Position (-100 - 100% Default: 0%)	
		Size	PIP Size (0 - 100% Default: 0%)	
	Crop	Left	Left Edge of the Crop (0 - 100% Default: 0%).	
		Right	Right Edge of the Crop (0 - 100% Default: 0%).	
		Size	Size of the Crop (0 - 100% Default: 0%).	
		Top	Top Edge of the Crop (0 - 100% Default: 0%).	
		Bot	Bottom Edge of the Crop (0 - 100% Default: 0%).	
		Soft	Transparency and range of the crop edge (0 - 100% Default: 0%).	
	Border		Border Off Normal Shaded 3D Bevel Bevel Shaded Dual Bevel Bevel Flat Flat Bevel 3D Glass Glass Shaded Dual Glass Glass Flat Flat Glass	Selection of border style (Default: Border OFF)

Main	Sub	Options and Parameters		
		Circle Circle Shaded Rounded Rounded Shaded		
		Luma	PIP Border Luma (0 - 100% Default: 0%)	
		Sat	PIP Border Color Saturation (0 - 100% Default: 0%)	
		Hue	PIP Border Color Hue (0 - 359 Default: 0)	
		Width	PIP Border Width (0 - 100% Default: 0%)	
		Soft	Distinctiveness of Border Edge (0 - 100% Default: 0%)	
		Opac	Border transparency (0 - 100% Default: 0%)	
		Direction	Direction of light source (0 - 359 Default: 0).	
	Shade Matte	Luma	Shade Matte Luma (0 - 100% Default: 0%).	
		Sat	Shade Matte Saturation (0 - 100% Default: 0%).	
		Hue	Shade Matte Color (0 - 359 Default: 0).	
		Shade Soft	This blurs or softens the Shade Matte area (0 - 100% Default: 0%).	
		Shade Pos	Sets position of the boundary line between Shade Matte and Border Matte (0 - 100% Default: 0%).	
	Inputs	Input	Source	Selection of an input to set the mode (Default: Input 1). Input 1-8
Mode			Three input modes are Live, Freeze, and Still (Default is Live).	
Type			HDMI SDI Auto	<b>Channels 3, 4, 7 and 8 are SDI/HDMI shared input channels, Depending on the physical connections at the rear panel, select the input interface accordingly.</b>
Mode <b>(Note: This option is currently disabled and will be available in future firmware upgrades.)</b>			OFF  CG Md	Mode disabled  Enables the CG mode <b>Note: This option is only available on HDMI inputs (HDMI 9 (CH3), 10 (CH4), 11 (CH7) and 12 (CH8)) so select HDMI in Type after selecting input 3, 4, 7 or 8.</b>
Proc Amp		Black	Black level (0 - 100% Default: 0%)	
		White	White level (0 - 100% Default: 0%)	
		Chrom	Chroma level (0.0 - 16.0 Default: 0)	
Audio		Gain	Audio volume of a selected video input (-64 – 24 dB Default: 0 dB).	
		Delay	Audio delay of a selected video input (0 – 340 ms Default: 0 ms).	
Crosspoint		Input 1-8 Off	Assign the selected input source to an input button (Default is Input 1).	



Main	Sub	Options and Parameters		
	Audio XPT	Input 1-8 External Follow	Associate the audio component of a selected input source to an input button (Default is Follow).	
Outputs	Output	SDI 1	Input 1 – 8	
		SDI 2	CLN PVW (Clean PVW)	
		SDI 3	CLN PGM (Clean PGM)	
		SDI 4	PG + DSK	
		HDMI 1	PVW	
		HDMI 2	PGM	
		HDMI 3	MultiV (Multi view) (SDI / HDMI default: None)	
		HDMI	YUV444 YUV422 RGB444	
	Multiviewer	AutoNum	Auto number input labels ( <b>ON/OFF (Default)</b> )	
		Label Inf	Input label is followed by information which describes the input as still, live or frozen image ( <b>ON/OFF (Default)</b> ). <b>Please note that the label content cannot be modified.</b>	
		Trns Lab	Turn the background of the label from a solid colour to transparent ( <b>ON/OFF (Default)</b> ).	
		MV1	Multiview Layout Modes Preset 1 <b>(Note: Presets 2 – 9 are currently unavailable and will be added in future firmware upgrades.)</b>	
		L: PGM / R: PVW L: PVW / R: PGM	<b>Default: L: PVW / R: PGM</b>	
	Tally Mode	Audio Mixer	Selection of tally light mode (Default: Normal)	
		Normal		
	GPI Out	ON/OFF	GPI Enable/Disable (Default: OFF)	
		Mode	Level/Pulse (Default: Pulse)	
		Width	Pulse width (Default: 1)	
		GPI-out assignment	Input 1-8 (Default: Input 1)	
		Delay	0-99 (Default: 0)	
	Audio	Audio	Mode	Turns <b>ON/OFF</b> embedded component at SDI-out and HDMI-out.
			Src	Selection of audio out source: <b>External (Default)</b> / Follow / Input 1-8
		PGM Audio	Mode	Audio transition style: X Fade / <b>V Fade (Default)</b>
Gain			Audio volume of a selected video input Range: -60 – 24 (dB) with <b>default = 0 dB</b>	
Delay			Audio delay of a selected video input Range: 0 – 340 ms with <b>default = 0 ms</b>	
Analog Out		Src	Selection of audio out source: <b>PGM Audio (Default)</b> / Follow / Input 1-8	
		Gain	Audio out volume Range: -60 – 24 (dB) with <b>default = 0 dB</b>	
		Delay	Audio out delay	

Main	Sub	Options and Parameters	
			Range: 0 – 340 ms with <b>default = 0 ms</b>
Files – User	Load Memory	Opens a numeric keypad to enter a memory location	Memory Selection from 1 to 1000 (Default: None)
		OK	Tap OK to load the memory location entered
	Save Memory	Opens a numeric keypad to enter a memory location	Memory Selection from 1 to 1000 (Default: None)
		OK	Tap OK to save to the memory location entered
Files – Stills	Load Still	Destination	Input 1 – 8
		Still Number	0 – 999
		Load Button	Tap Load to load from the selected still number
	Save Still	Source	Input 1 – 8
		Still Number	0 – 999
		Save Button	Tap Save to save to the selected still number
	Grab Still	Grab Destination	Input 1 – 8
		Grab	Tap Grab to grab the current program view to the selected destination
	Delete Still	Still Number	0 – 999
		Delete Button	Tap Delete to remove the still picture from the selected still number
Files – Stinger	Load Stinger	Clip Memory Locations	0 – 999
		Load Button	Tap Load to load the selected clip
	Stinger Settings	Start Frm	Sets the clip's start and end frames and the transition frame.
		Mid Frm	
		End Frm	
	Clear Stinger	Clear	Clear the loaded clip
	Delete Stinger	Clip Memory Locations	0 – 999
Delete Button		Tap to remove the selected clip	
<b>Note: The Stinger transition effect is currently unavailable and will be added in future firmware upgrades.</b>			
Files – Logo	Load Logo	Logo Destination	Logo 1 Logo 2
		Logo Memory Location	Memory locations from 0 to 999
		Load Button	Loads the selected logo
	Clear Logo	Clear	Clear the loaded logo
	Delete Logo	Logo Memory Location	Memory locations from 0 to 999
		Delete Button	Remove logo from a memory location
	Logo 1	X	X coordinate from -50 to +50
		Y	Y coordinate from -50 to +50
Logo 2	X	X coordinate from -50 to +50	
	Y	Y coordinate from -50 to +50	
Files – Ani-Logo	Load Ani Logo	Ani Logo Destination	Logo 1 Logo 2
		Ani Logo Memory Location	Memory locations from 0 to 999
		Load Button	Loads the selected ani logo

Main	Sub	Options and Parameters		
	Clear Ani Logo	Clear	Clear the loaded ani logo	
	Delete Ani Logo	Ani Logo Memory Location	Memory locations from 0 to 999	
		Delete Button	Remove animated logo from a memory location	
	Logo 1	X	X coordinate from -50 to +50	
		Y	Y coordinate from -50 to +50	
	Logo 2	X	X coordinate from -50 to +50	
		Y	Y coordinate from -50 to +50	
Setup	Standard	Resolution	<b>3840x2160p60/59.94/50/30/29.97/25</b> <b>1080p60/59.94/50/30/29.97/25</b> Resolution Selection	
		Save Button	Saves the selected resolution	
		Level	Audio Standards EBU SMPTE AUTO (Default)	
	Genlock	On/Off	Default: Off	
		H Phase	-2190 – 2190 ms (Default: 0)	
		V Phase	-1124 – 1124 ms (Default: 0)	
	<b>Note: Genlock is currently unavailable and will be added in future firmware upgrades.</b>			
	Keyboard	Brightness	1 – 7	
	Auto Save	ON / OFF	Automatically saves the last settings before the machine is shut down; once turned ON auto save also occurs upon every Still Load.	
	Factory Def	Factory Default	Factory Default Reset loads the default configuration from memory point 0 for all configuration options except for the Setup.	
		Reset Input Names	Resets the Multiviewer labels to the default settings	
	Language	English Traditional Chinese Simplified Chinese		
	Network	SE-4000 DHCP	On/Off (Default: Off)	Main Unit
		SE-4000 IP Address	192.168.100.101 (Default)	
		SE-4000 Network Mask	255.255.255.0 (Default)	
		CTL DHCP	On/Off (Default: Off)	Control Panel
		CTL IP Address	192.168.100.102 (Default)	
CTL Network Mask		255.255.255.0 (Default)		
Software	Software	Tap Upgrade to start the FW upgrade process See the <a href="#">Firmware Upgrade</a> section for the USB firmware update process.		
	App Version	Display of version numbers only		
	SW Version			
	Firmware			
	OS Version			

The following sub-sections will show you various options available in the menu.

## 5.1 Start

The Start menu allows the user to set the transition time, the transition type as well as various wipe effects. The menu options are described below.

### *Transition*

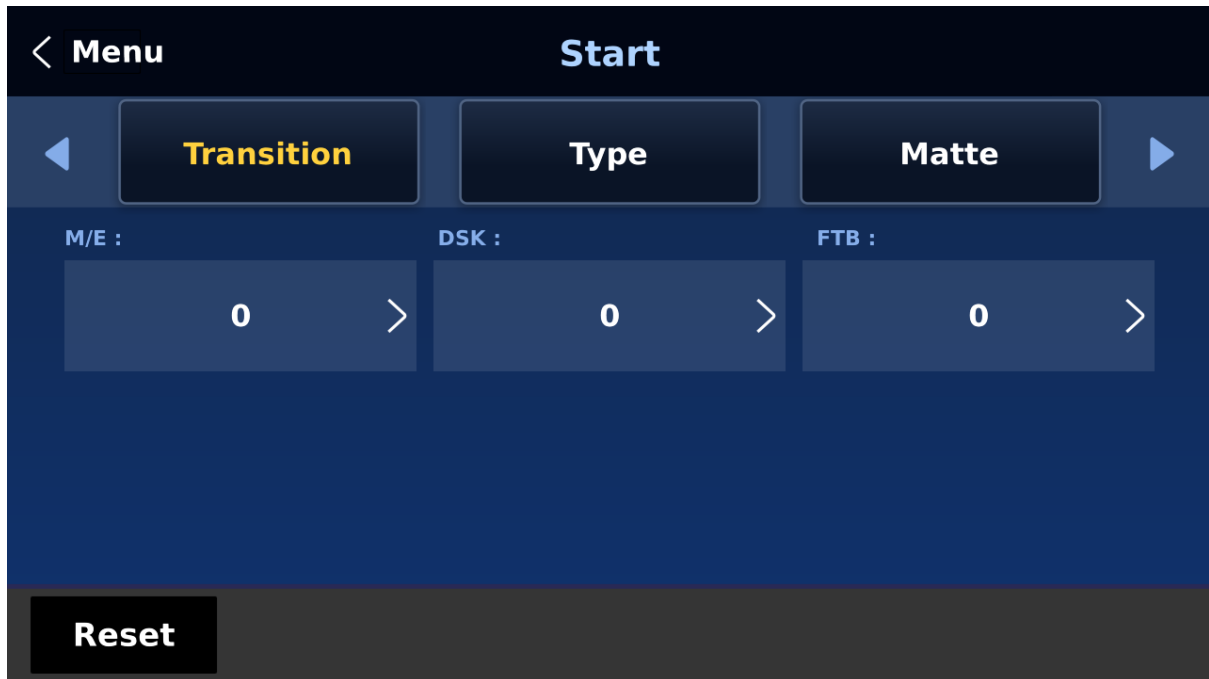

The **Transition** option allows the user to set the transition duration, in frames, for switching the PGM view when using the **MIX**, **DSK AUTO** and **FTB** buttons.

For example, if the **M/E** is set to a value of 50, then the transition will take effect over a period of 50 frames or roughly 2 seconds. When the **AUTO button** is pressed, the transition will take the current M/E value defined by the user setting.

### *Type*

The SE-4000 provides four major types of transition effect, which are **Clip (Stinger)**, **WIPE (2D)** and **Mix**. Please note in addition to selecting the transition effect in the menu, you can also press **MIX**, **WIPE** or **STINGER button** to enable the respective transition effects.

**Note: The Stinger transition is currently under development so the function cannot be used.**

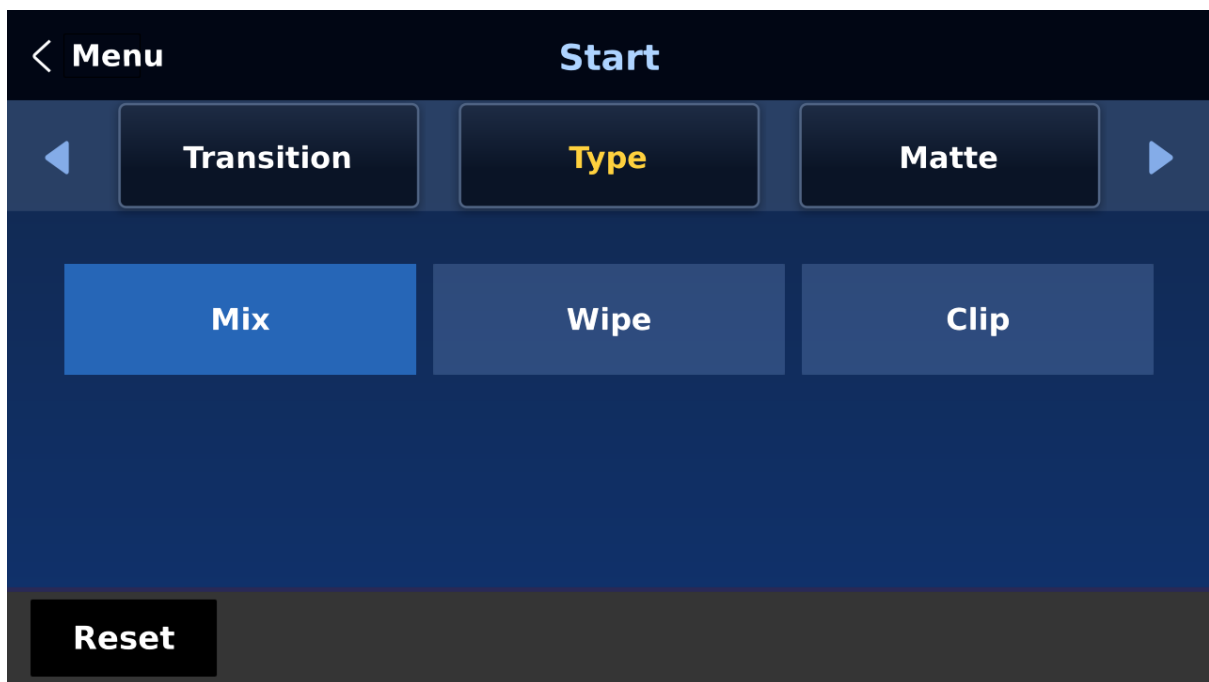

- For **MIX** effect, set the transition time in “**Start → Transition → M/E.**”  
Note: You can press the **MIX** button to activate the MIX effect.
- For **WIPE** effect, set the relevant WIPE settings in “**Start → WIPE Effects.**”  
Note: You can press the **WIPE** button to activate the WIPE effect.

### **Matte**

The user can open the Matte view by pressing the **BG** button of the **Program** and **Preview** button rows. The color of the Matte is configurable in this option by adjusting **Luma**, **Saturation** and **Hue**.

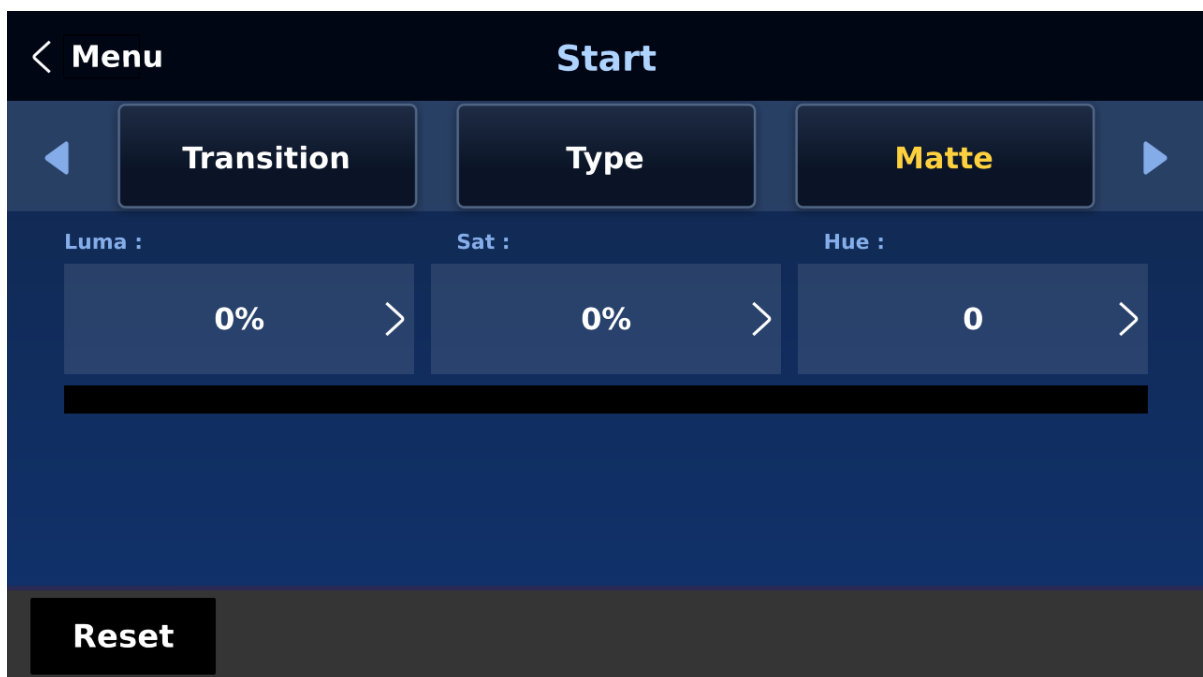

For **Hue** value, **Red** is 0, **Green** is approximately 120 and **Blue** is approximately 240. For secondary colors, **Yellow** is approximately 60, **Cyan** is approximately 180 and **Violet** is approximately 300.

The **Sat** or **Saturation value** refers to the intensity of the color selected in **Hue**. As the saturation increases, the color appears to be more pure. As the saturation decreases, the color appears to be more washed-out or pale.

The **Luma value** relates to how bright or dark the selected color or hue is. The higher the **Luma** value, the brighter the color selected in **Hue**.

### ***Wipe Effects***

In “**WIPE Effects**,” the user is allowed to select the Wipe style and configure the wipe’s border softness and width.

- **Wipe** – Selection of a WIPE effect from a set of 32 WIPE transition effects.
- **Soft** – A low value results in a solid edge and a high value gives a soft diffused edge.
- **Width** – A low value results in a thin edge and a high value gives a wide edge.

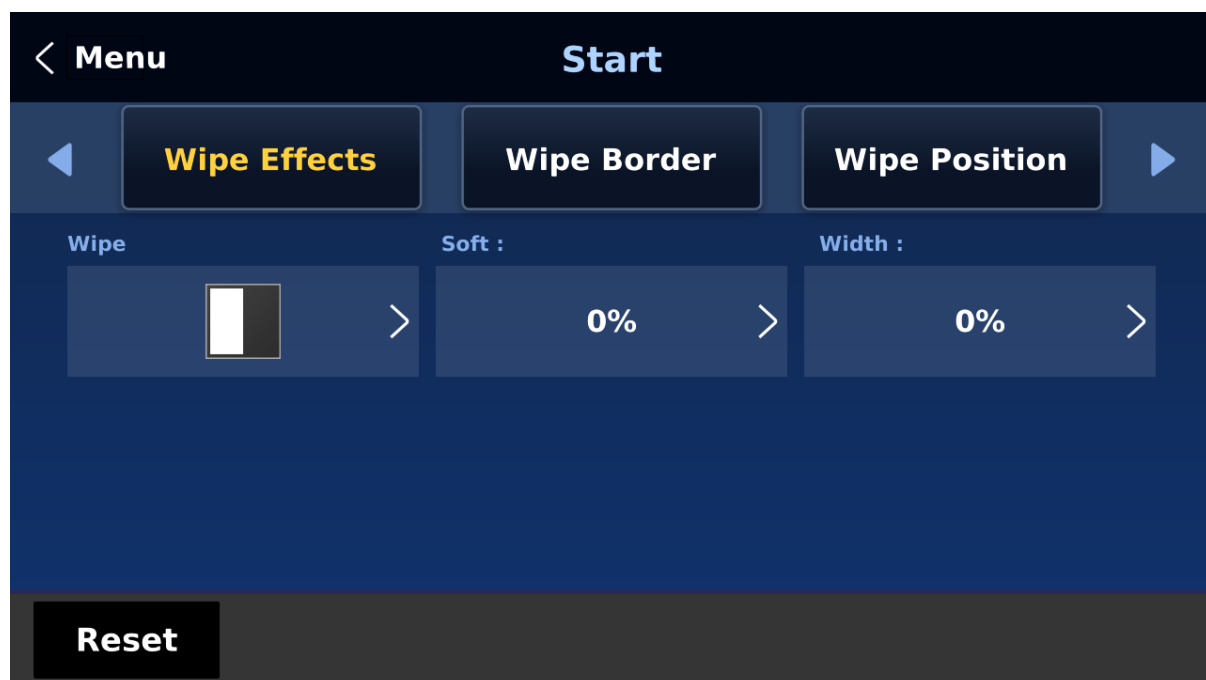

### ***Wipe Border***

In this option, the user will be allowed to fine-tune the border color by adjusting the **Luma**, **Saturation** and **Hue** values.

**Note:** Enable the **WIPE border** by setting the border width (**Width**) to a value greater than 0. The **WIPE border** is disabled when the border width is set to 0.

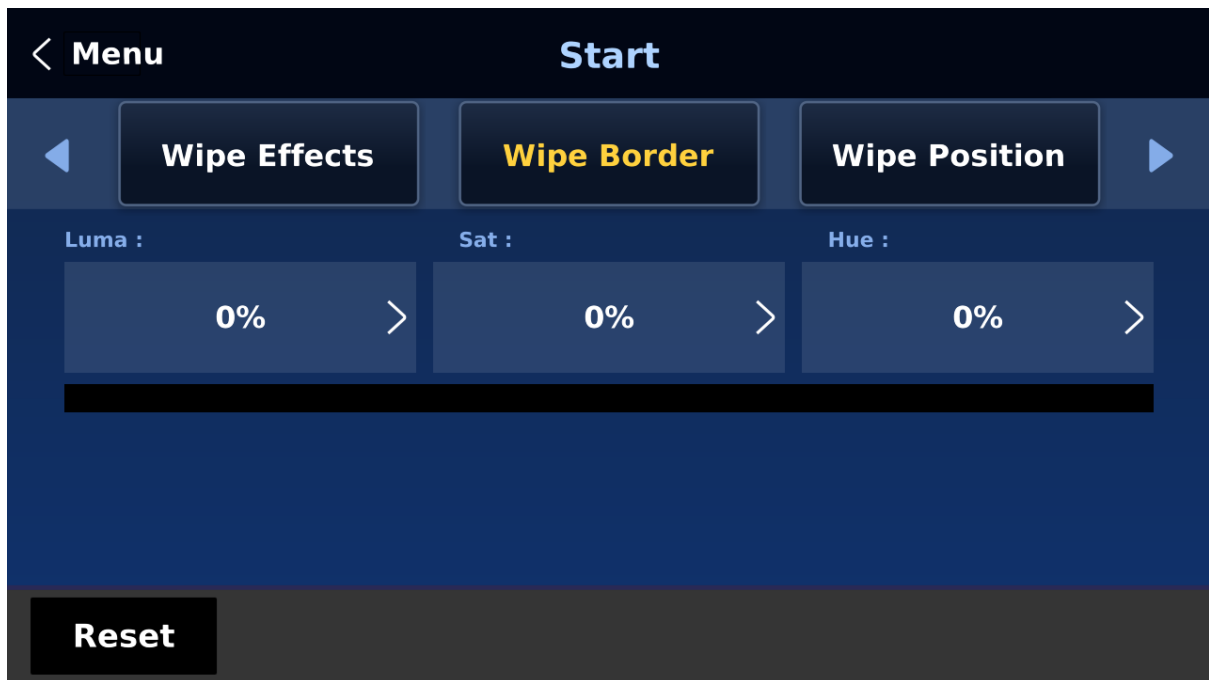

### ***Wipe Position***

Position allows the user to adjust the center position of certain wipes (e.g Circle & Ellipse). **X** represents the horizontal position and **Y** is the vertical position.

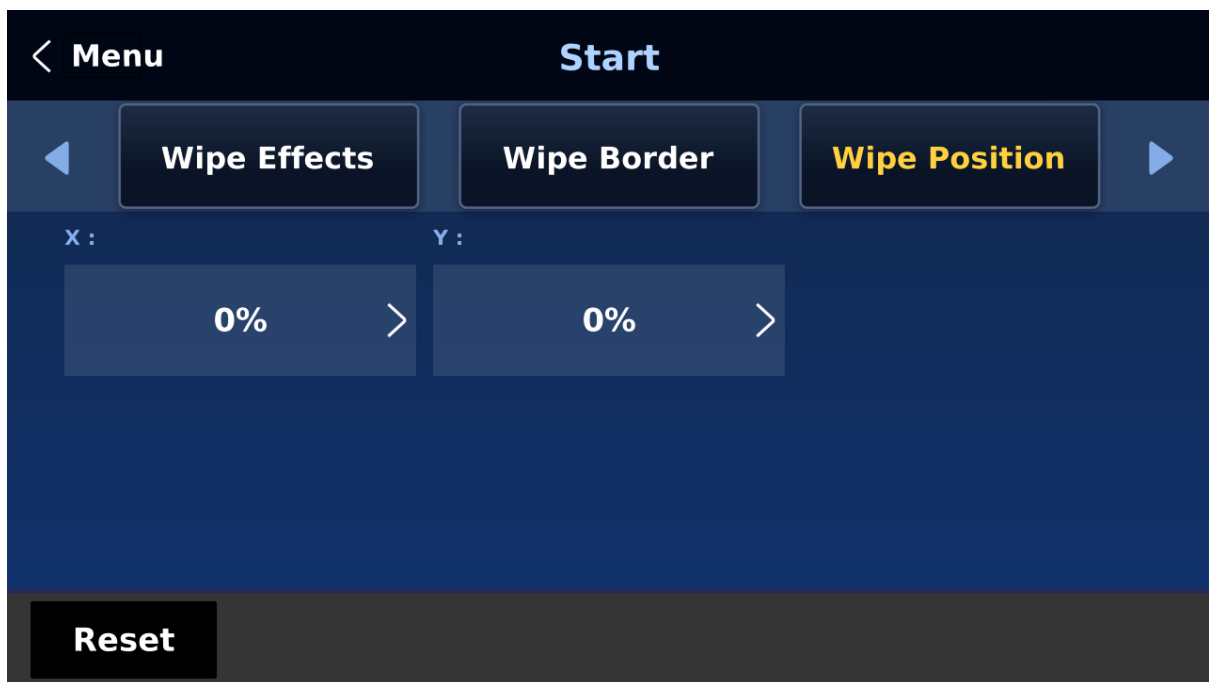

#### **Horizontal Position (X)**

Positive value moves the wipe center to the right.

Negative value moves the wipe center to the left.

Zero value positions the wipe center at the screen center

#### **Vertical Position (Y)**

Positive value moves the wipe center up.

Negative value moves the wipe center down.

Zero value positions the wipe center at the screen center.

## 5.2 Keyer

Keyer of the SE-4000 provides the user with the capability of image keying. In this sub menu, the user will be able to configure the eight keyers available on the SE-4000.

### Keyer

The 6 keyer options are **Key 1**, **Key 2**, **Key 3**, **Key 4**, **DSK 1**, and **DSK 2**.

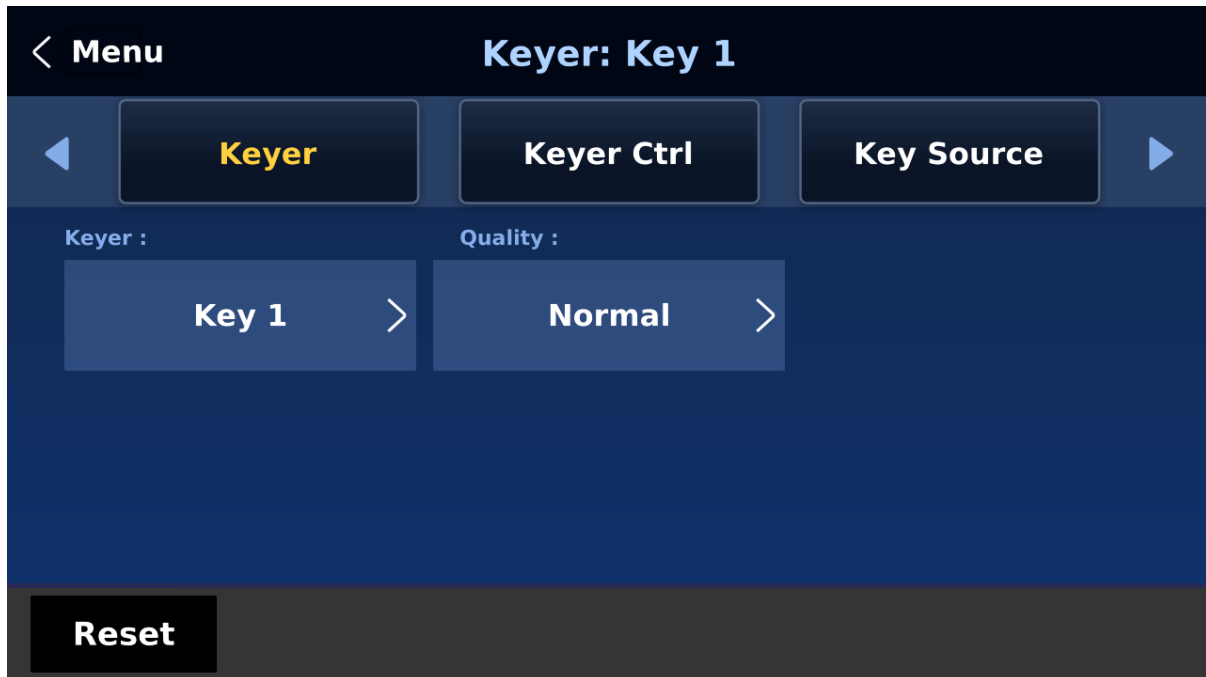

Key 1 – 4 are usually configured for luma and chroma keyers so select **Self** since only one source is enabled for such keyers.

The DSK keyer options are **Linear** and **Luma**. After the DSK keyer option is chosen, select **Self** if only one source is enabled for the DSK keyer, which is the Key source. Select **Split** if two sources are enabled for the DSK keyer, which are Fill and Key sources. An example of a Linear DSK self setup could be using an HDMI input from a Windows laptop running Datavideo's CG-500 Character Generator software; see [Character Generator](#) for more information.

Once configured, the keyers can be activated by pressing the corresponding keyer buttons on the switcher's control panel.

Select **Fine** if you require high keying quality and **Normal** for original keying quality.

### Keyer Control

There are three keying modes available: **Linear**, **Luma**, and **Chroma**.

**Linear** keying mode is usually chosen for sharp images as it is usually used in professional graphic design. For non-sharp images, please select **Luma** keying for basic text images. **Chroma** keying mode allows you to remove the green or blue backdrop from the image and is usually used in overlapping talent on a background image.



Please note that if you select Full, the keying effect will be disabled, keeping the original source image. For example, if you select Full → PIP, no keying effect will be applied to the PIP image source.



After the keying mode is chosen, select **Self** if only one source is required for the keyer, which is Key source. Select **Split** if two sources are required for the keyer (DSK), which are Key and Fill sources. You can also select **P-in-P** to apply the keying effect to the PIP image source.

If **Luma** keying is selected, the key image (**Key Source**) is configured by adjusting **lift**, **gain** and **opacity** parameters.

**Lift** adjusts the dark/black areas of the key image. **Reducing the value of Lift** will make dark areas of the key image more transparent. The background image will be showing only through the transparent areas.

**Gain** adjusts the light/white areas of the key image. **Increasing the value of Gain** will make light areas of the key image more solid. The background image will be showing only through the transparent areas.

**Opac** adjusts the transparency of the overall foreground key image. **Increasing the value of Opacity** will make the overall key image less transparent.

**Invert** configures the luma key color. Turning it on allows the luma key to remove the white background and turning it off allows the luma key to remove the black background.

**Please note:**

**If Chroma is selected, adjust the Chroma Keyer parameters in the Chroma sub menu.**

**If P-in-P is selected, adjust its parameters in the P-in-P sub menu.**

For example, if the user selects **Key 1 → Chroma → P-in-P**, you will then be able to apply the chroma key effect to the P-in-P window after configuring the corresponding chroma keyer

parameters in the **Chroma** sub menu. To enable the P-in-P window with the chroma key effect applied, press **Key 1 PGM** or **PVW** button on the switcher's control panel.

### **Key Source**

This option allows you to select the key and fill sources.

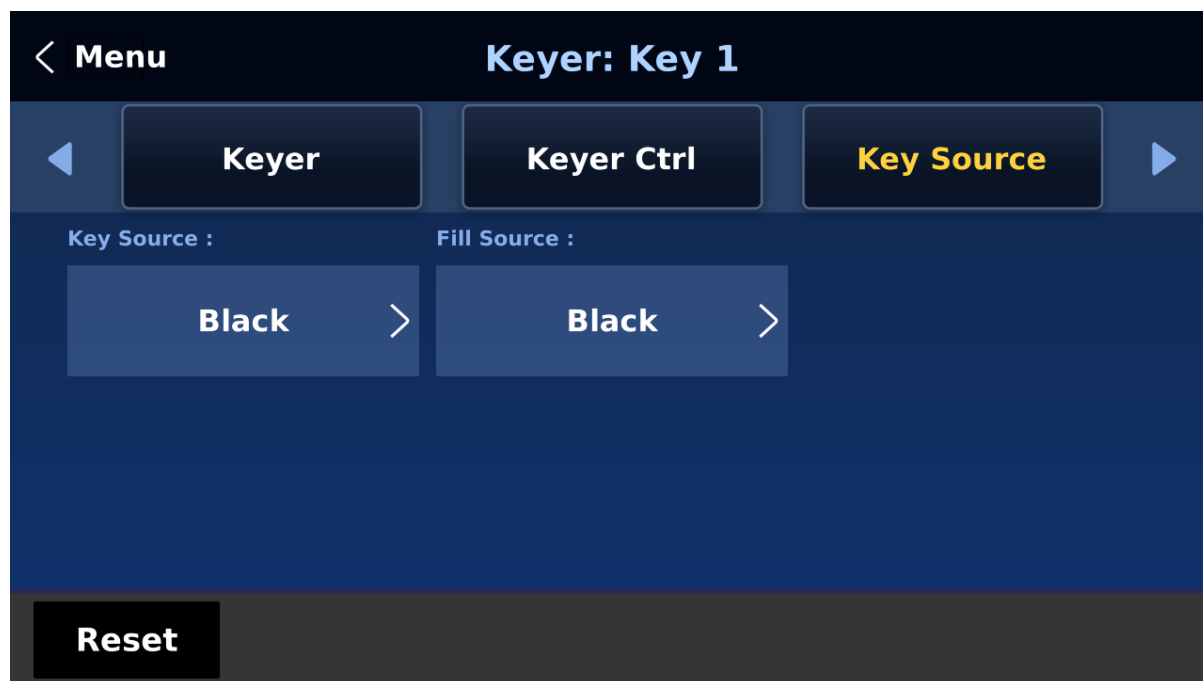

Select the key source from the list below:

- Bars: Color bars
- Matte: A configurable color screen and the Matte value can be set in **Matte** option of the **Start** menu
- Input 1 – 8: Image source loaded to channel buttons 1 – 8
- Black: Black Screen

Select the fill source from the list below:

- Bars: Color bars
- Matte: A configurable color screen and the Matte value can be set in **Matte** option of the **Start** menu
- Input 1 – 8: Image source loaded to channel buttons 1 – 8
- Black: Black Screen

### **Mask**

The Mask feature basically shrinks the source image by removing borders of the final image. In this option, the user is allowed to configure the Mask in chroma, luma or linear mode by adjusting **Left**, **Right**, **Top** and **Bottom** parameters.



- **Left** – Left sets the left edge of the keyer mask.
- **Right** – Right sets the right edge of the keyer mask.
- **Top** – Top sets the top edge of the keyer mask.
- **Bottom** – Bottom sets the bottom edge of the keyer mask.

### 5.3 Chroma

The Chroma Keyer removes the green background of the key image. If **Chroma** is selected in **Keyer**, this option menu allows you to configure the corresponding parameters.

#### **Keyer**

First, select the **Keyer** (**Key 1**, **Key 2**, **Key 3** or **Key 4**) that has been set to the chroma key.

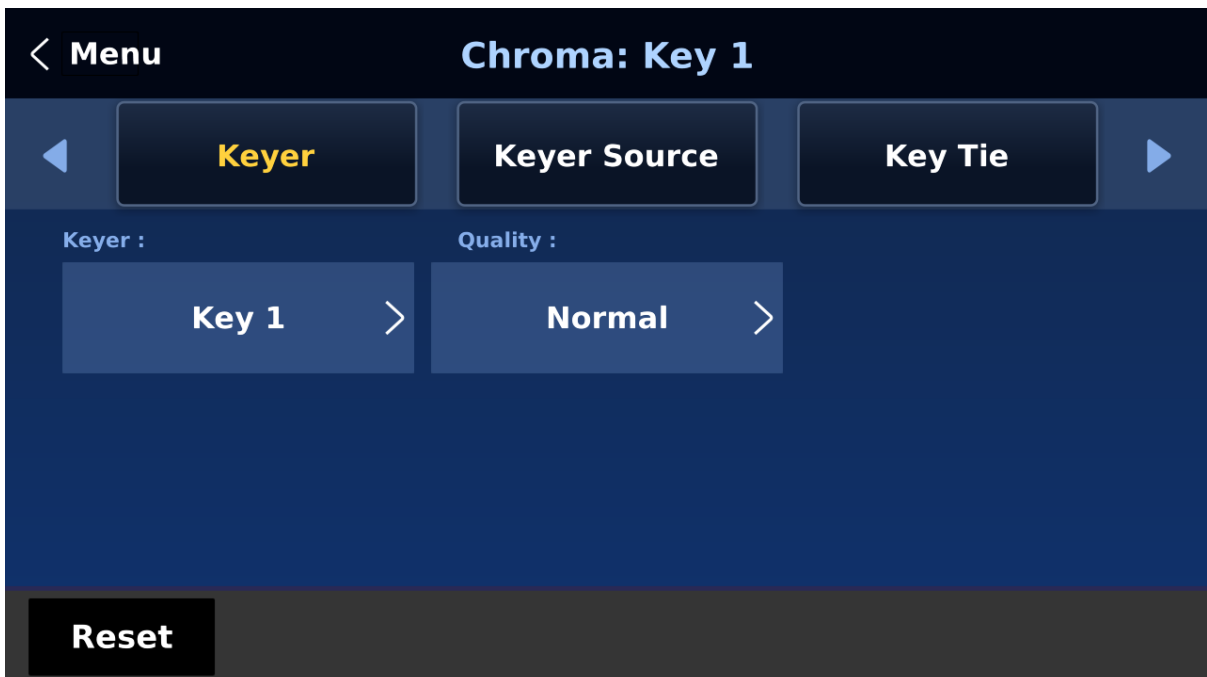

Select **Fine** if you require high keying quality and **Normal** for original keying quality.

Next, select one video source from all available options in **Key Source**.

### **Key Source**

Assign a key source to the keyer selected.



Various options are listed below:

- Bars: Color bars
- Matte: A configurable color screen and the Matte value can be set in **Matte** option of the **Start** menu
- Input 1 – 8: Image source loaded to channel buttons 1 – 8
- Black: Black Screen

### **Key Tie**

Key tie is a feature that allows you to overlay a foreground image on a background image. The key tie image can then be opened by pressing the corresponding input button of the background image. **Note that if key tie is enabled for a particular keyer, the corresponding keyer button will be disabled.**

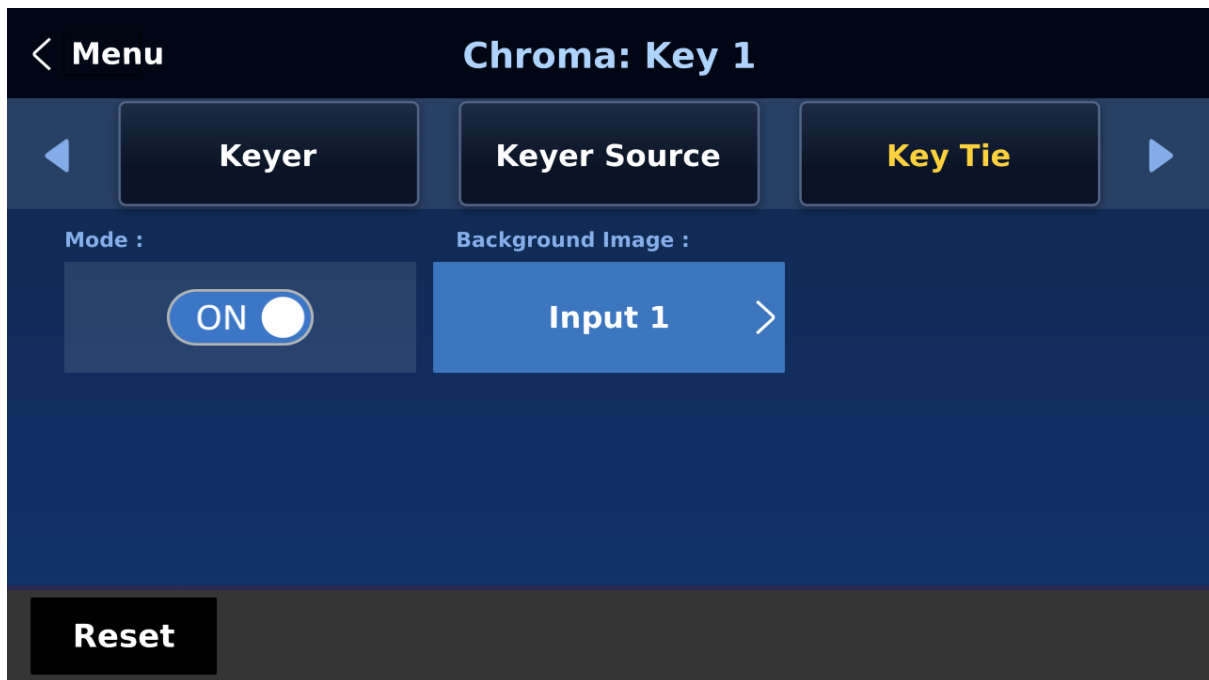

Outlined below are steps to set key tie with the chroma keyer.

1. First, in the Keyer menu, select the keyer and set it to Chroma. We used Key 1 in this example.

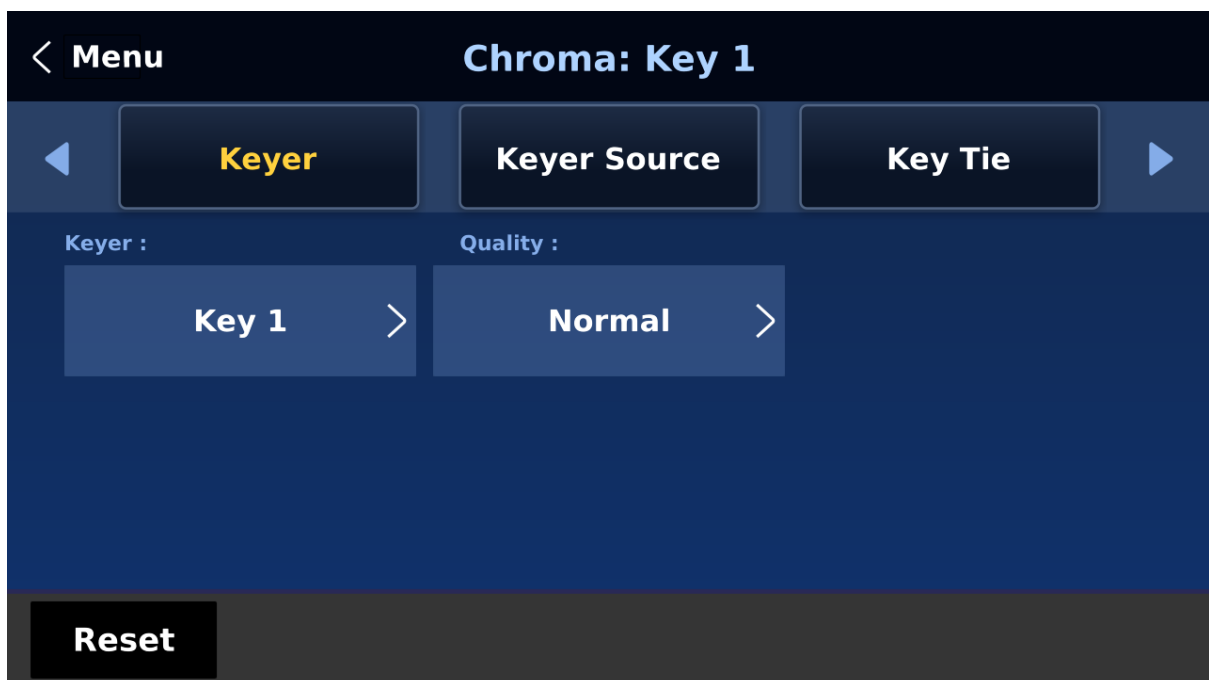

2. Open the Chroma menu and select Key 1. Select a foreground image from the Key Source list (the foreground image is usually a person or an object against a green backdrop).



3. Enable Key Tie and on the right, select a background image.

Below are available sources of the background image:

- Input 1 – 8
- Off

**Note: You will not be able to use the keyer button once key tie is enabled. Use the input button that is assigned the background image to open the key tie image.**

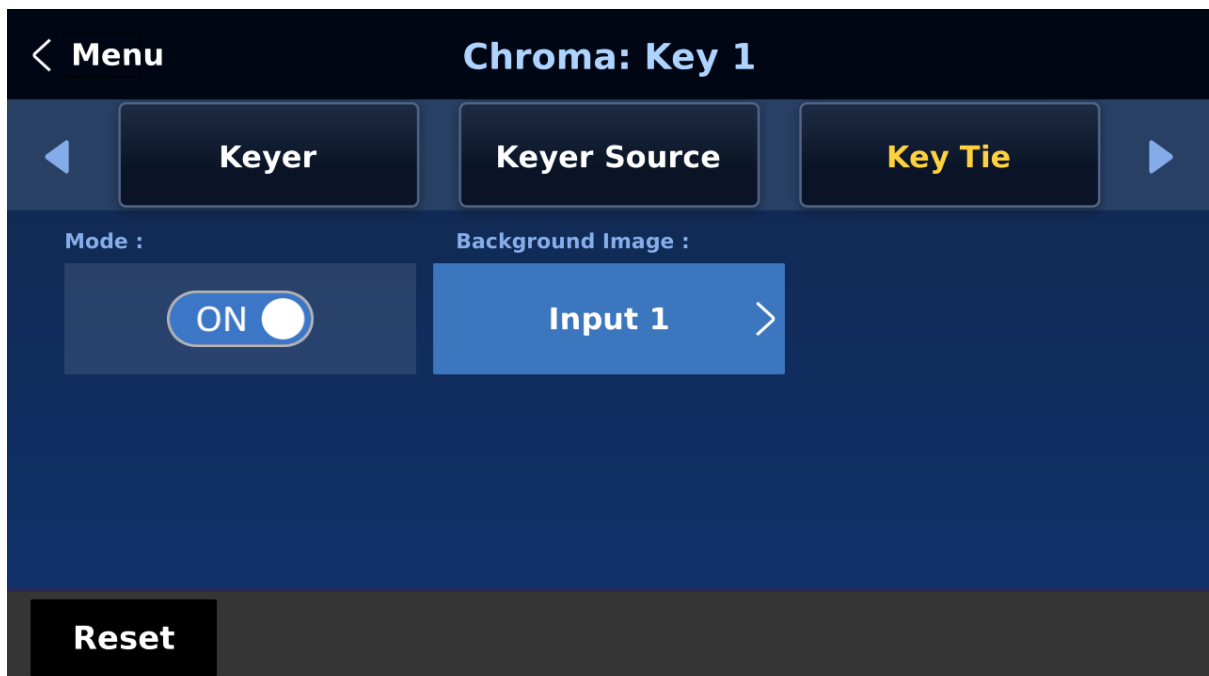

4. After key tie is configured, to open the key tie image, simply press the corresponding input button of the background image selected at Step 3. In this example, input 1 is selected as the background so press button 1 of either the Preview or Program row to open the key tie image on the respective views.

## CK Setup

In CK Setup, the user will be able to find all the parameters needed to perform chromakeying of the green or blue backdrop.

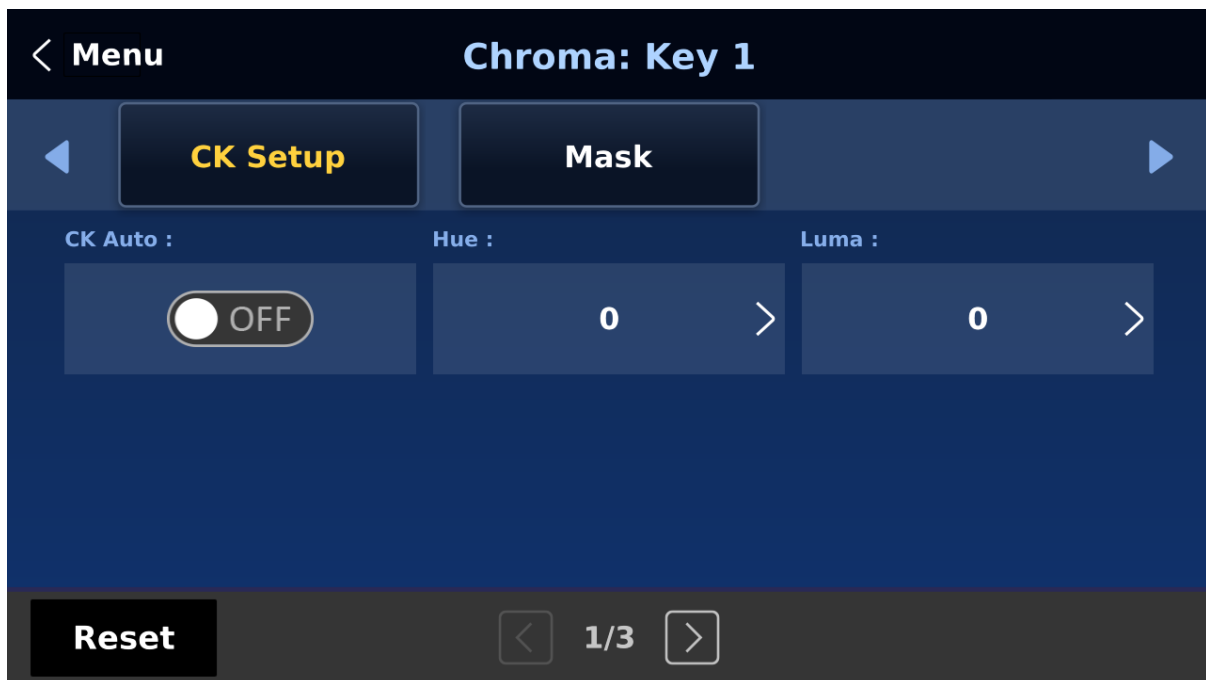

**CK Auto:** This function automatically calculates the best Hue & Luma values for the current Keyer source. After applying the CK Auto effect, the result can be fine-tuned by adjusting the Luma and Hue values.

**Hue:** This parameter adjusts the color of the chroma key. A typical green screen value will be around 120. Blue screen value will be around 240.

**Luma:** This parameter adjusts the luma value of the chroma key



**K Range** (Key Range): Key Acceptance sets the range of hues or colors (0 – 360 degrees) that closely match the background color to be keyed. The user can start with a value of 120 degrees and this value can be fine-tuned up or down depending on the setup of the green or blue screen studio.

**K Fgnd** (Key Foreground): **Key Foreground** adjusts the performance of the chroma key in light or white areas. Apply more **Key Foreground** if the light areas are becoming too transparent.

**K Bgnd** (Key Background): **Key Background** adjusts the performance of the chroma key in dark or black areas. Apply more **Key Background** if the dark areas are becoming too transparent.

**Hi-Light**: Hi-light boosts the foreground key in high luminance area.

**Lo-Light**: Lo-light boosts the foreground key in low luminance area.

**Bg-Supp**: **Background Suppress** removes the Luma (Brightness) of the background from the final image. **Bg-Supp** turns ON/OFF background suppression.

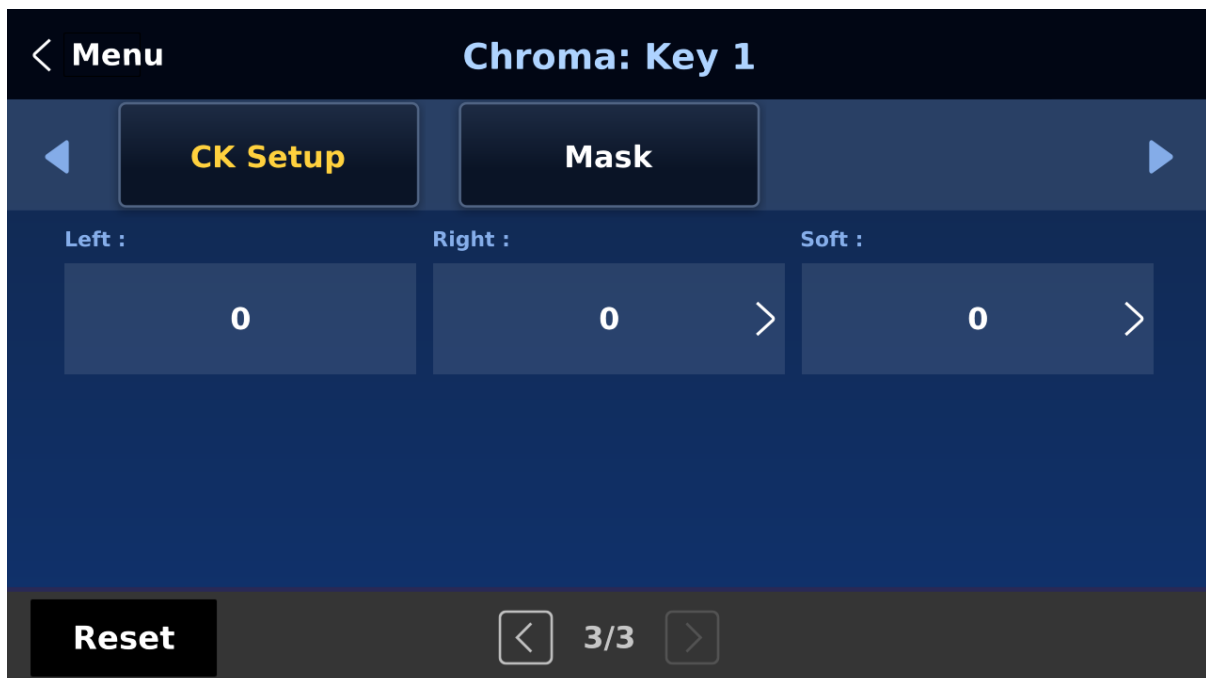

**Left**: Trims the left edge of the key object.

**Right**: Trims the right edge of the key object.

**Soft**: Determines the distinctiveness of key edge

### **Mask**

The Mask feature basically shrinks the camera image by removing the borders from the final image. This feature allows the user to configure the Mask in chroma, luma or linear mode.



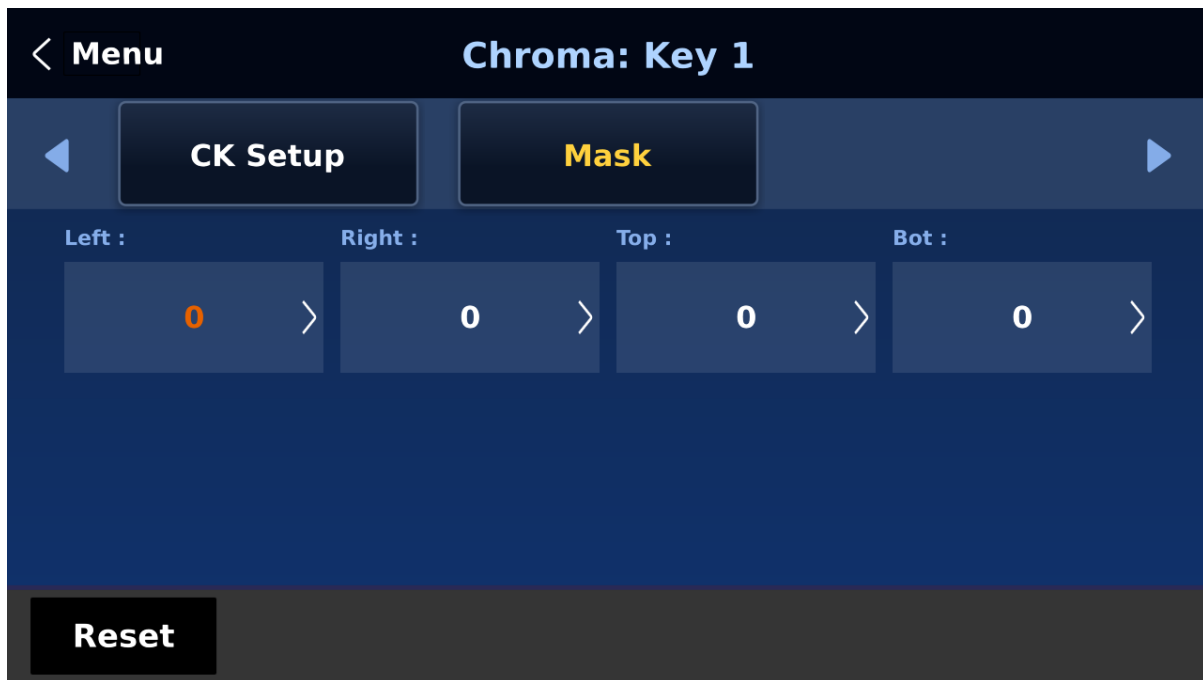

- **Left** – Left sets the left edge of the keyer mask.
- **Right** – Right sets the right edge of the keyer mask.
- **Top** – Top sets the top edge of the keyer mask.
- **Bottom** – Bottom sets the bottom edge of the keyer mask.

## 5.4 P-In-P

The **P-in-P** menu allows the user to adjust various parameters for the PIP window. Use this menu to configure your PIP window if **P-in-P** is selected in **Keyer Control** of the **Keyer** menu for a particular keyer.

**Note:** The keyer image source can only be selected in **Key Source** of the **Keyer** menu and the supported resolutions are 4K, 1080p and 1080i.

### ***P-in-P***

In **P-in-P**, the user will be allowed to select a keyer that has been set to the PIP window. Please note that Keyers 1 – 4 are active for PIP configuration only if P-in-P is selected in the Keyer menu for the respective keyer.

- **Key 1**
- **Key 2**
- **Key 3**
- **Key 4**

You may set all four keyers to PIP but only two PIP windows can be activated at the same time.

In **Quality**, select **Fine** to fine tune the position of the P-in-P window by adjusting **X** and **Y** vales as well as the **Size** in **Position** sub menu. This feature allows you to move the P-in-P window more precisely to the desired location and adjust its size.

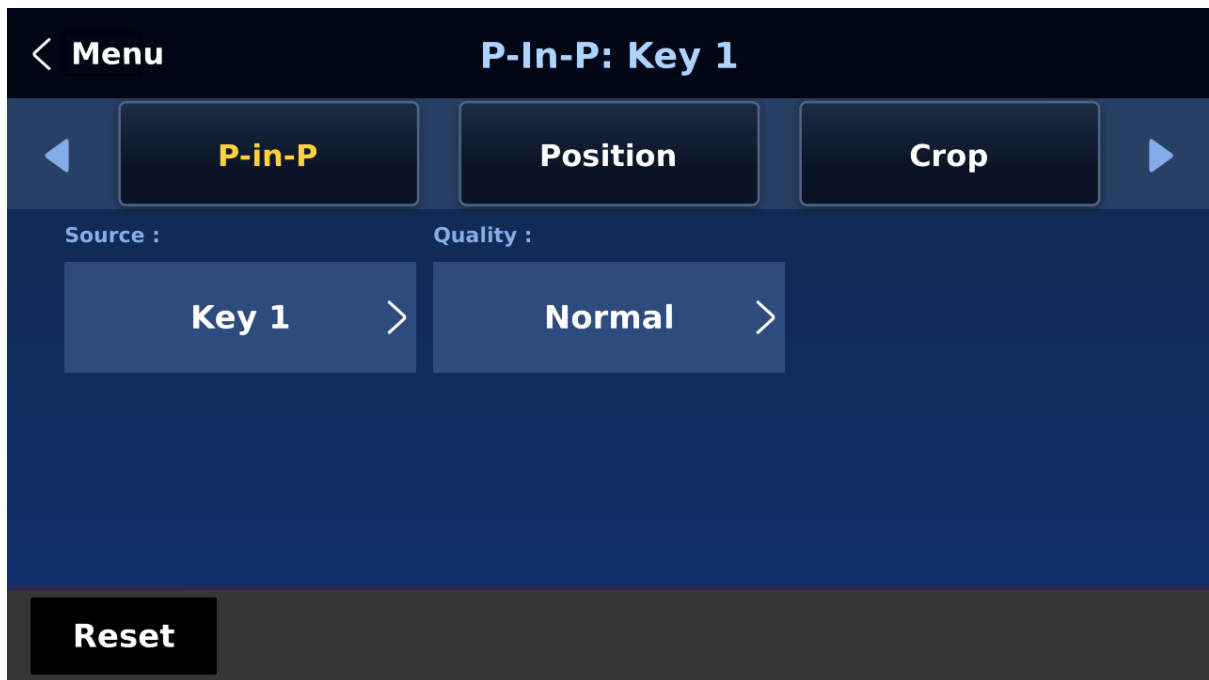

**Position**

The user can adjust the P-in-P window position by adjusting values of **X**, **Y** and **SIZE** with the corresponding sliders, where X is the horizontal position, Y is the vertical position and Size is the PIP screen size.



**X-Value**    Positive value: position the P-in-P window to the right.  
                  Negative value: position the P-in-P window to the left.  
                  Zero value: Position the P-in-P window at the center.

**Y-Value**    Positive value: move the P-in-P window up.  
                  Negative value: move the P-in-P window down.  
                  Zero value: Position the P-in-P window at the center.

**Size** Ranges from 0 to 50 with 1 being the smallest and 50 being the largest or 1920x1080.

Regardless of the resolution (4K, 1080p or 1080i), setting the size to 50 would mean a P-in-P window that is one quarter of the size of the background image or 1920 x 1080.

### **Crop**



The PIP image crop can be adjusted by modifying the following parameters:

- **Left** – Adjusts the position of the left edge of the PIP image.
- **Right** – Adjusts the position of the right edge of the PIP image.
- **Size** – Adjusts the PIP image crop size.
- **Top** – Adjusts the position of the top edge of the PIP image.
- **Bot** – Adjusts the position of the bottom edge of the PIP image.
- **Soft** – Adjusts the crop edge transparency.

### **Border**

The user is also allowed to add borders to the PIP window.



The SE-4000 offers various border styles listed as follows:

- Border Off
- Normal
- Shaded\*
- 3D Bevel\*\*
- Bevel Shaded\*
- Dual Bevel\*\*
- Bevel Flat\*\*
- Flat Bevel\*\*
- 3D Glass\*\*
- Glass Shaded\*
- Dual Glass\*\*
- Glass Flat\*\*
- Flat Glass\*\*
- Circle\*\*
- Circle Shaded\*
- Rounded\*\*
- Rounded Shaded\*

\*See [Shade Matte](#) for dual color border setting.

\*\*See [Direction](#) for border shadow setting.

To turn the Border off, simply select the option “Border OFF.”

In addition to assigning a style to the border, the user is also allowed to set border color by adjusting **Luma**, **Saturation** and **Hue** values. **Luma** and **Saturation** range from 0 to 100%. **Hue** value ranges from 0 to 355.

The borders can also be widened or narrowed by adjusting **Width**. Please note that a width of zero (0) will turn the PIP border off.

**Note:** You will sometimes see black thin lines on your PIP image after setting the PIP border to Normal with a border width of zero. This is caused by using an image that differs from its original size. To remove these lines, turn the border off or use the crop function to shrink the image until the lines disappear.

**Softness** defines the distinctiveness of the border edge. A low value results in a solid border edge and a high value gives a soft diffused border.

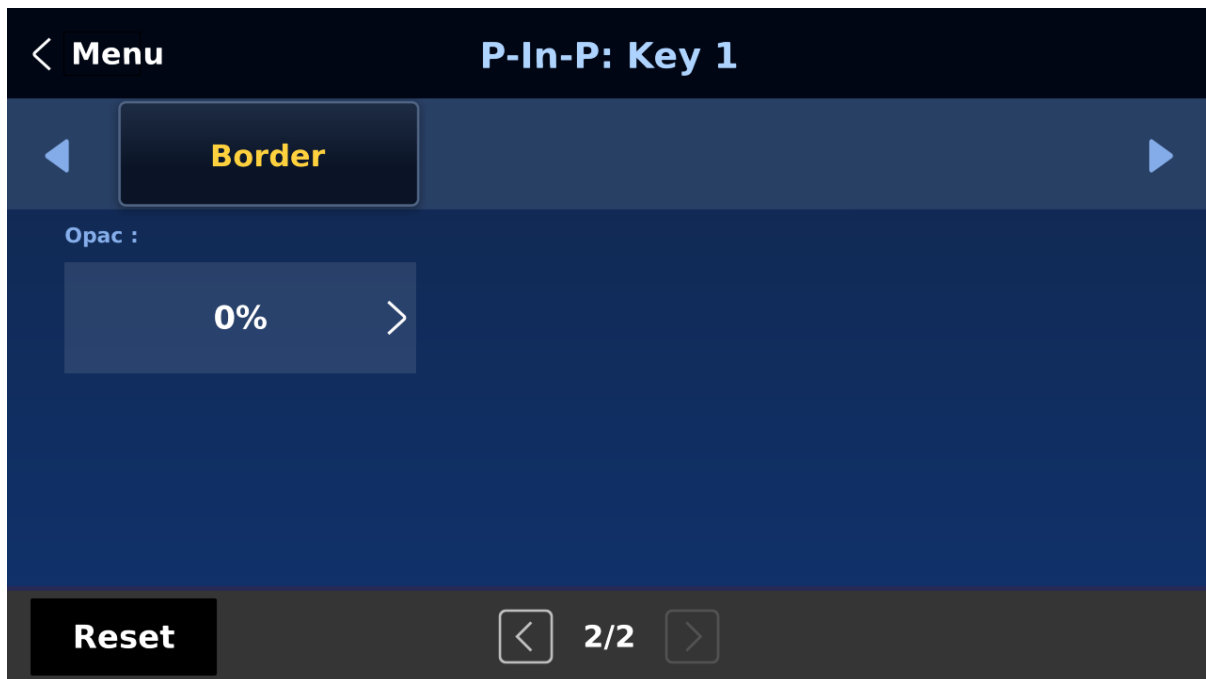

**Opac** adjusts the transparency of the border, ranging from 0% to 100%

**Direction** sets the direction of the light source with the value of parameter ranging from 0 to 355. The default is 35, which indicates a direction of North East. You will see the border's color shadow changes as the Direction value is changed. The directions that specific parameter values correspond to are listed as follows:

- 0: North
- 90: East
- 180: South
- 270: West

### ***Shade Matte (Dual Color Border)***

In order for the **Shade** effect to work, **Shaded Border (Dual Color)** must be first selected as the **Border** such as **“Shaded”, “Bevel Shaded”, etc.** For more information about border settings, see the previous section [Border](#).



Shade Matte determines the inner border. The boundary between the normal border matte and the shade matte can be determined by adjusting the **Shade Position** parameter.

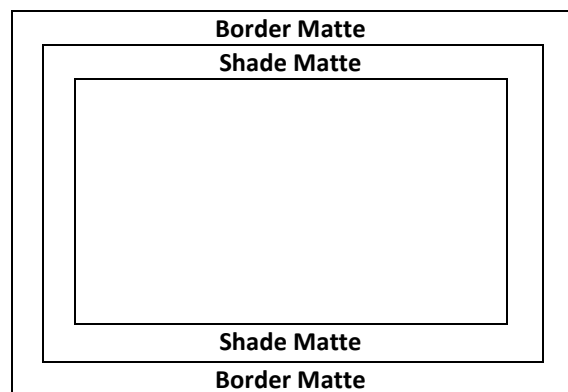

### Luma, Sat and Hue

The color of the **Shade Matte** can also be controlled by adjusting the **Hue, Sat** and **Luma** values.

For **Hue** value, **Red** is 0, **Green** is approximately 120 and **Blue** is approximately 240. For secondary colors, **Yellow** is approximately 60, **Cyan** is approximately 180 and **Violet** is approximately 300.

The **Sat** or **Saturation value** refers to the intensity of the color selected in **Hue**. As the saturation increases, the color appears to be more pure. As the saturation decreases, the color appears to be more washed-out or pale.

The **Luma value** relates to how bright or dark the selected color or hue is. The higher the **Luma** value, the brighter the color selected in **Hue**.

### Shade Softness and Position

The **Shade Matte** can be further configured by adjusting its **softness (Shade Soft)** and **width (Shade Pos)**.

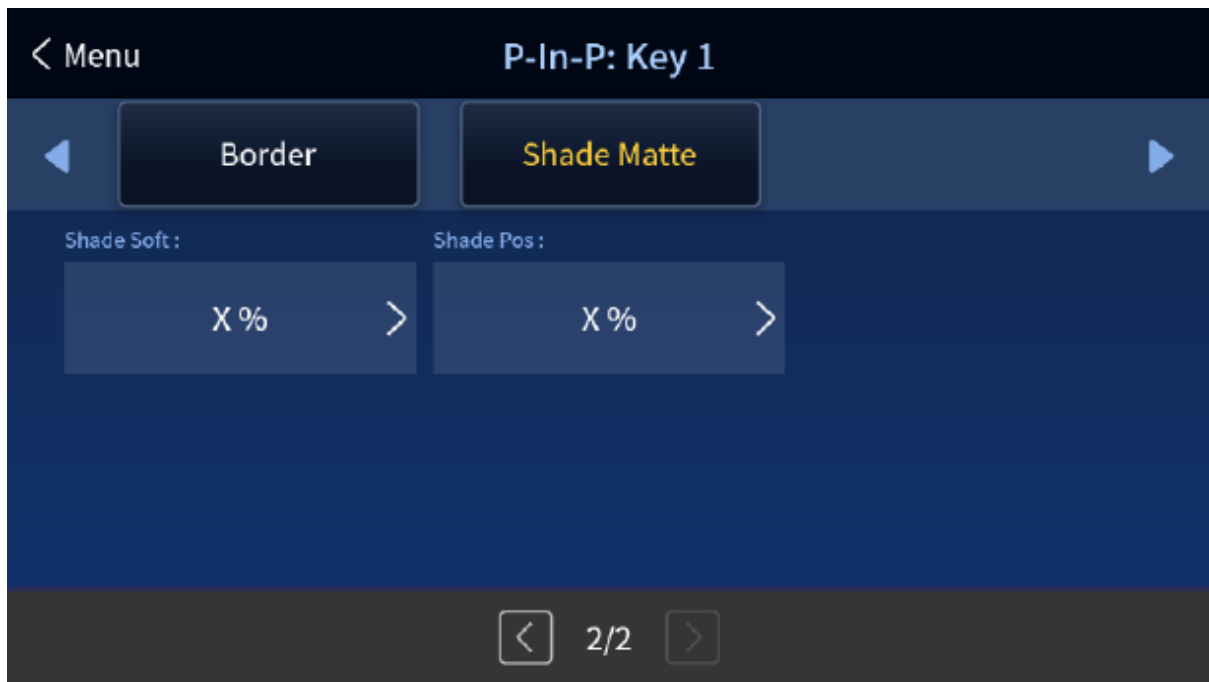

### Shade Soft

This blurs or softens the *Shade Matte* area.

### Shade Position

The position of the boundary line between *Shade Matte* and *Border Matte* is controlled by the **Shade Pos** value.

Increasing this value moves the boundary line such that the *Shade Matte* occupies less of the width of the border. Decreasing this value moves the boundary line such that the *Shade Matte* occupies more of the overall border width. When this value is 0, the *Shade Matte* occupies all of the border width.

## 5.5 Inputs

This feature allows the user to set operation modes for the selected input, configure the input color by adjusting its **Black Level**, **White Clip** and **Chroma Gain** parameters and adjust the audio volume and delay. In addition, the Crosspoint function allows the user to shuffle contents of Inputs 1-8 without changing physical connections at the back of the machine.

## Input



In this sub menu, you will be allowed to set the mode of display for the respective Input windows of the Multiview display. First select the input that you would like to configure and then for each selected input, set the mode of input by selecting one of the modes **from the first mode option**:

- Still – Displays the still picture loaded into Inputs 1-8 in the respective input window.
- Freeze – Freezes the current video played in the Input window.
- Live – Live view or video display in the Input window.

### Input Type

Channels 3, 4, 7 and 8 are SDI/HDMI shared input channels, depending on the physical connections at the rear panel, specify the input interface accordingly.

### Color Space

Select an option from the list below to provide details of the color primaries for interpretation of XYZ color space.

- Auto: System determined color space.
- REC709: REC709 is the standard camera encoding color space for HDTV established by International Telecommunication Union in 1990.
- BT2020: A 4K RGB color space that has a color gamut that is wider than all other RGB color spaces.

### Mode of Operation

The second mode option allows you to select the mode of operation for inputs 3, 4, 7 and 8 when their input type is set to HDMI.

**OFF:** When input type is set to SDI.



**CG Mode:** HDMI ports of the switcher allow keying of CG text or graphics (1080p60/59.94/50) over live video (4K/60/59.94/50/30/29.97/25 and 1080p/60/59.94/50/30/29.97/25). Enable CG mode to use this feature. See [Character Generator](#) for more details.

### **Proc Amp**

Proc Amp allows the user to configure the input color by adjusting its Black Level (0 – 100%), White Clip (0 – 100%) and Chroma Gain (0 – 16) parameters.

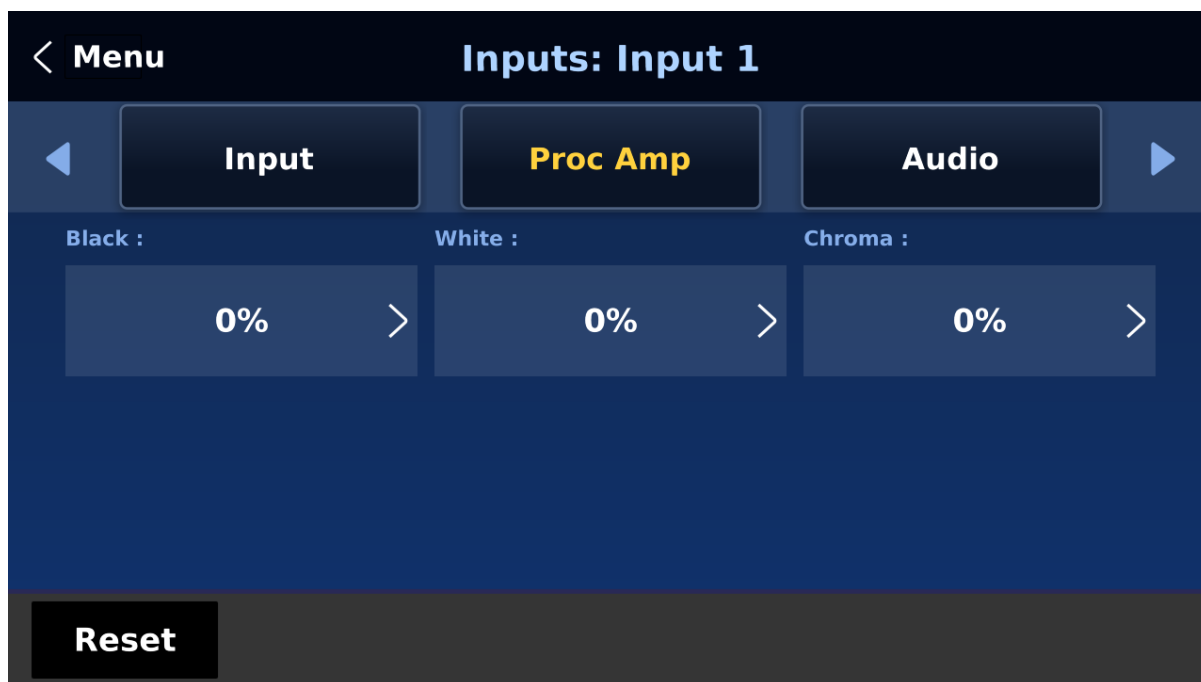

### **Audio**

**Gain (0 – 24 dB):** adjustment of the input audio volume for the selected video input.

**Delay (0 – 340 ms):** sets the delay of the audio component of the selected video input.

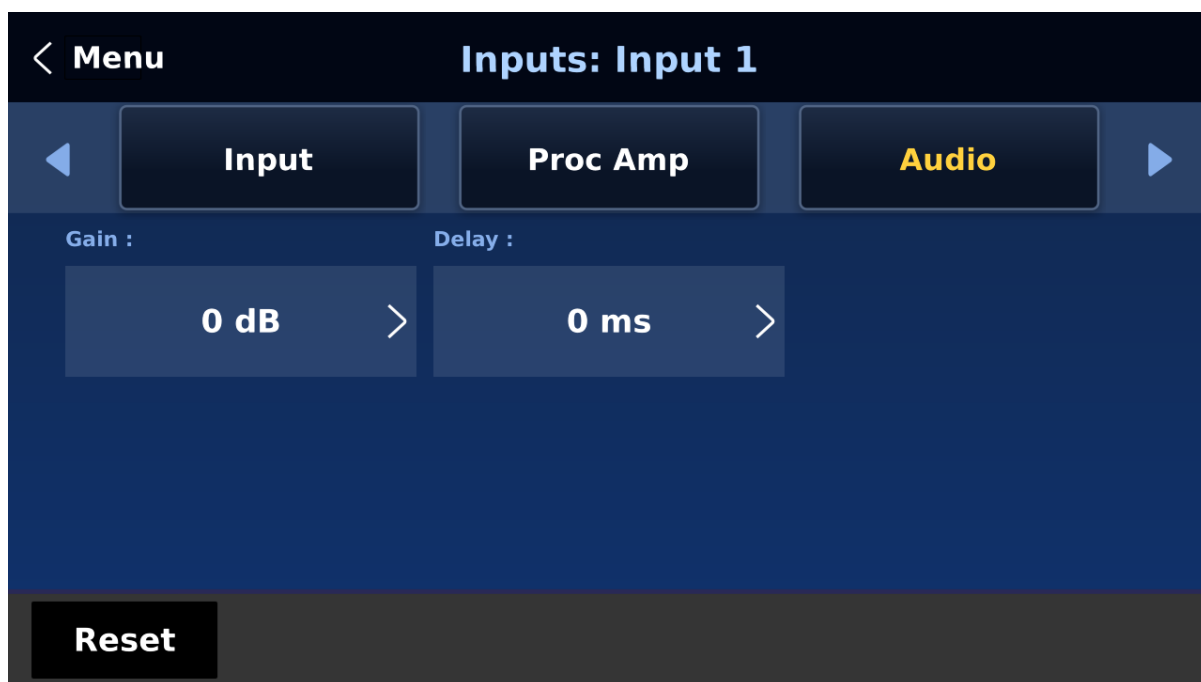

### **Crosspoint**

The crosspoint function allows the user to shuffle the contents of Inputs 1-8 without changing the physical connections at the back of the machine. In the example below, the input 1 video source is assigned to input 3, so the input 3 window should display the input 1 video. Select OFF if you would like to disable the crosspoint function. Available options are listed as follows:

- Input 1-8
- OFF



### **Audio XPT**

The Audio XPT feature allows the user to associate the audio component of any input source to any of the input buttons (1 – 8), thus cross assigning audio input channels to program/preview row buttons.

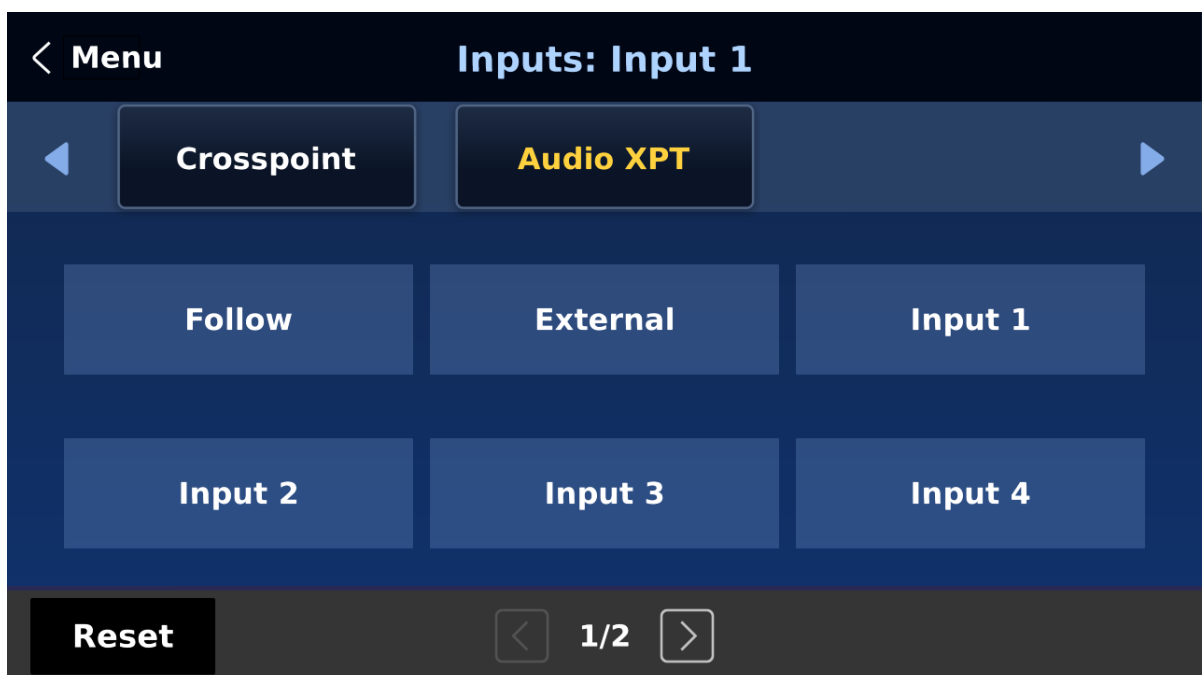

Available options are listed as follows:

- Input 1-8
- External
- Follow

“**External**” selects audio source from AUDIO IN ports.

Select “**Follow**” to set the audio to Audio-Follow-Video mode in which the PGM audio is played via **AUDIO OUT** port. Please note that there will be no audio delay.

## 5.6 Outputs

This menu allows the user to configure various output settings such as video output, tally mode and GPI connection.

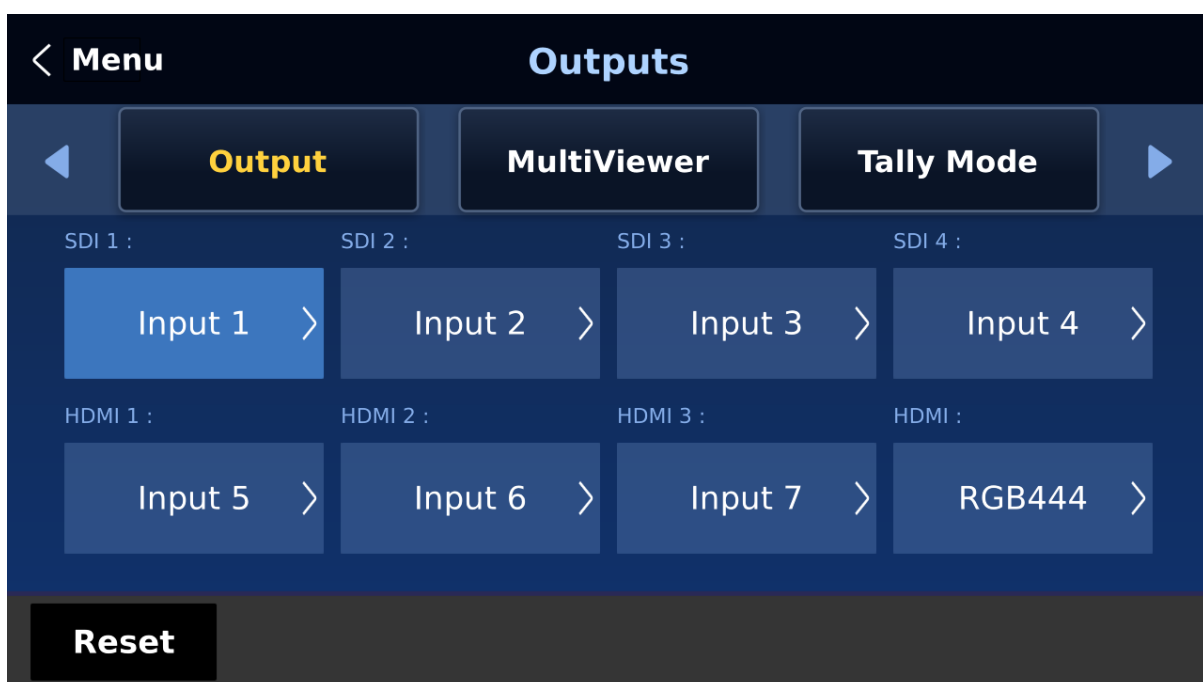

### **Outputs**

In general, the SE-4000 offers 7 output ports (**SDI 1 – 4 / HDMI 1-3**) and all 7 ports can be configured to output one of the following:

- Input 1 – 8
- CLN PVW (Clean PVW)
- CLN PGM (Clean PGM)
- PG + DSK
- PVW
- PGM
- MultiV (Multi view)

Select the HDMI color space in **HDMI**. The available options are YUV444, YUV422 and RGB444.

## Multiviewer

The Multiviewer sets the Multiview display.

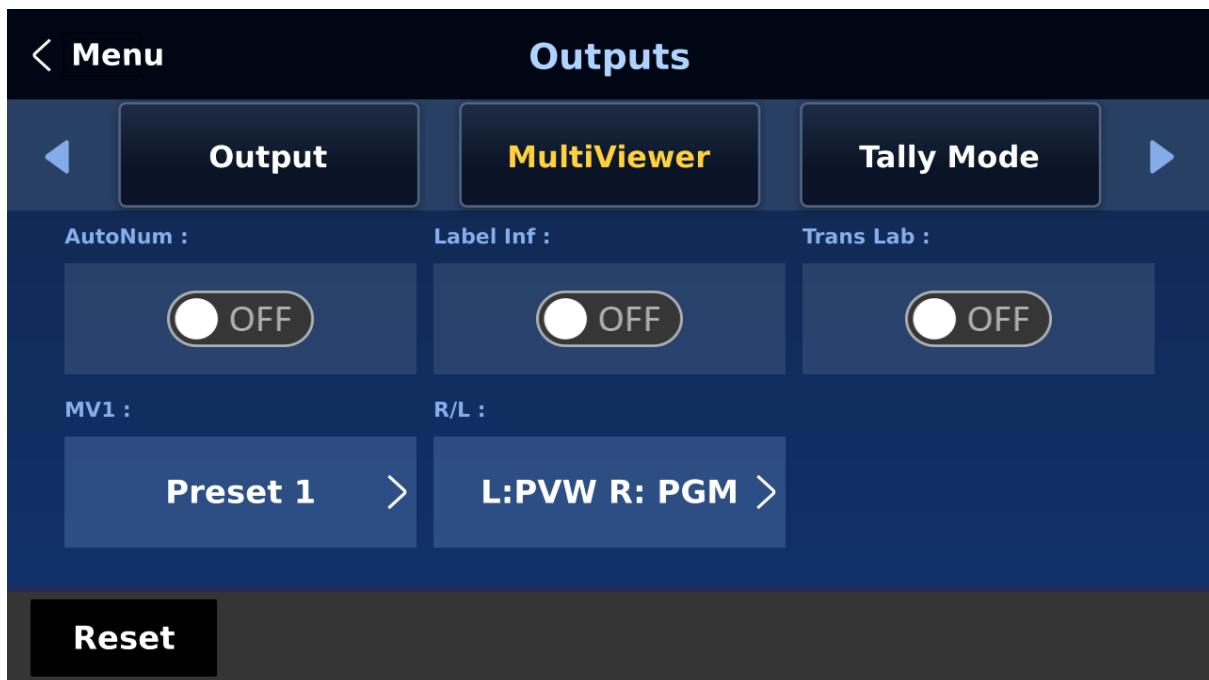

**AutoNum:** The Multiview's input windows can be automatically numbered, and this option turns ON/OFF automatic numbering.

**Label Inf** turns ON/OFF the label information of the input windows. The input label indicates whether the input is still (stl), live (\*), or a frozen image (frz). **Please note that the label content cannot be modified.**

**Trans Lab** turns ON/OFF the Label Background Transparency. Once enabled, the background of the label should turn from an opaque black to a transparent one.

### MV1

The SE-4000 Multi-view monitoring is available in different multi-image layouts. These outputs can be used to monitor video and audio in a number of different configurations. For each setup, embedded audio level indication is also available on all inputs as well as the Preview and Program windows.

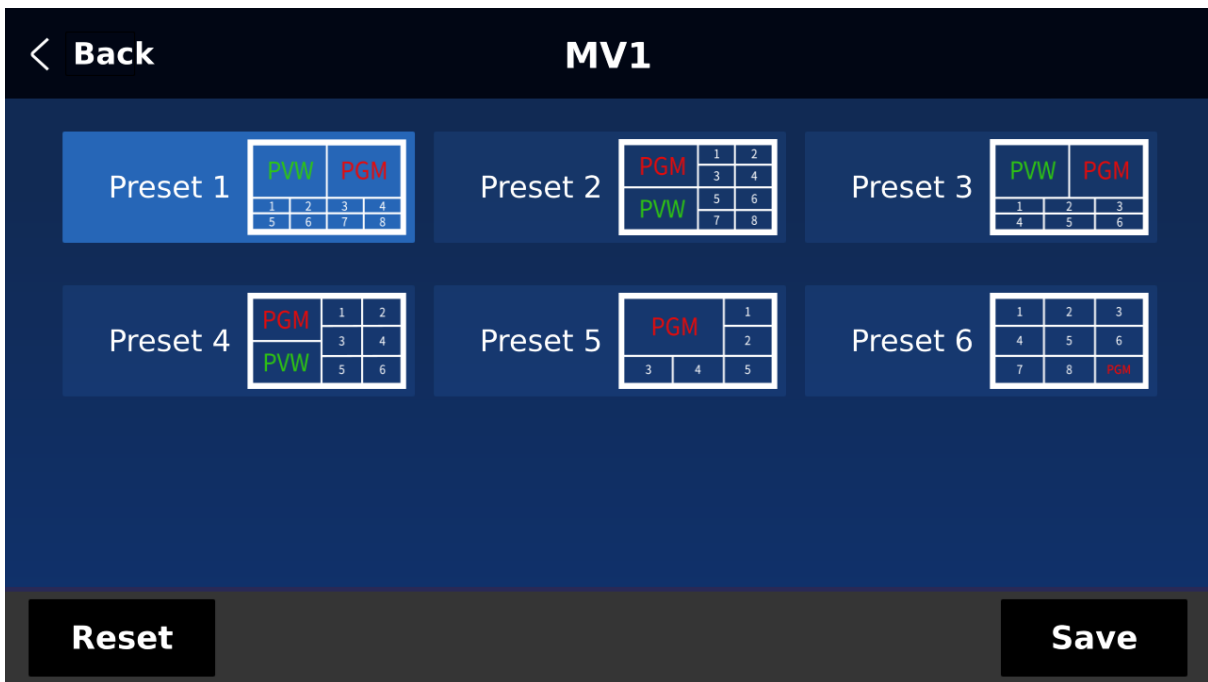

### R/L

On the Multiview, by default, Preview window is positioned on the left and on the right is the Program window. This option allows you to switch their positions.

### Tally Mode

Tally output port generally sends two tally signals to each channel. In Datavideo products, **Red** indicates On-Air, and **Green** indicates next video source. On the Multiview screen, the tally light is indicated by rectangular borders around the input sub windows.

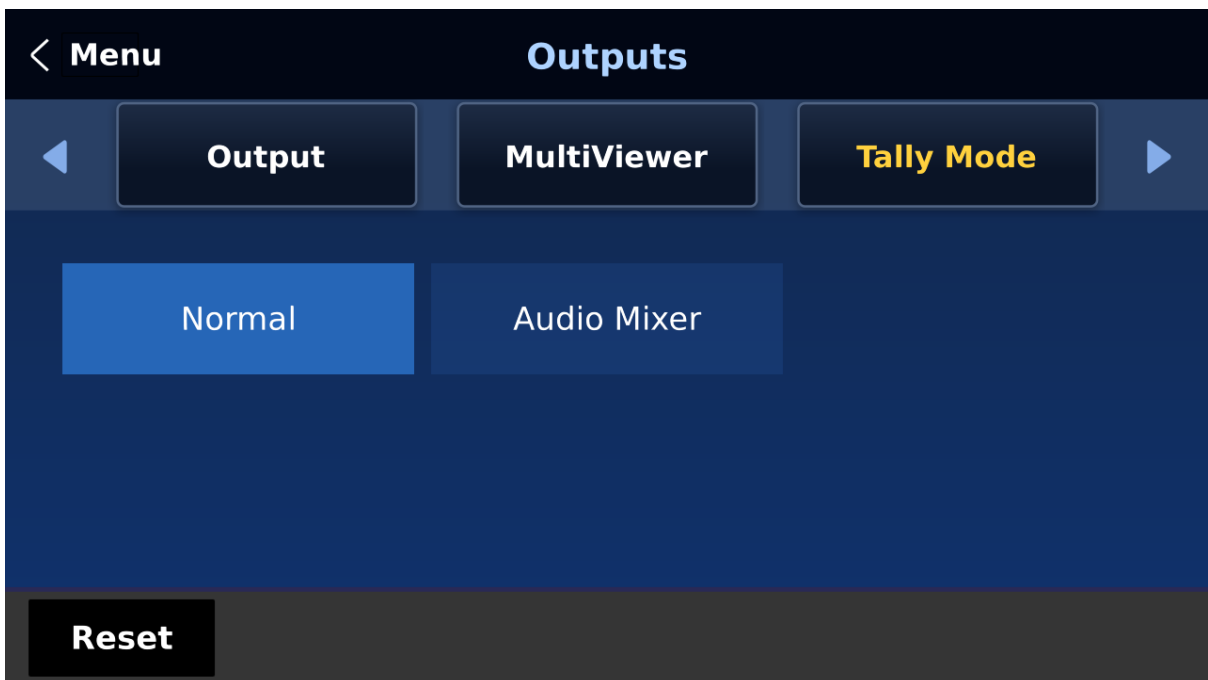

The SE-4000 provides two tally modes:

**Normal:** If in normal mode, tally lights of all video sources enabled on PGM view will be turned ON (**Red**). These sources include PGM, PIP and Key sources. While transition is in progress,

tally lights of all video sources enabled on PGM view do not change color. The tally light will only change color (**Red** → **Green**) after transition of PGM and PVW views is complete. However, for video sources on the Preview window, the tally lights will be enabled **Green**, and the color is changed to **Red** as soon as the transition is triggered.

**Audio Mixer:** If Audio Mixer mode is selected, tally lights of all video sources enabled on PGM view will be turned ON (**Red**). While transition is in progress, tally lights of all video sources enabled on PGM view do not change color. The tally light will only change color (**Red** → **Green**) after transition of PGM and PVW views is complete. However, for video sources on the Preview window, the tally lights will be enabled **Green**, and the color is changed to **Red** as soon as the transition is triggered.

### **GPI Out**

GPI is designed to allow the user to trigger playback of an external playback device such as Datavideo's HDR-80/90. **GPI OUT** allows the user to configure your GPI connection.

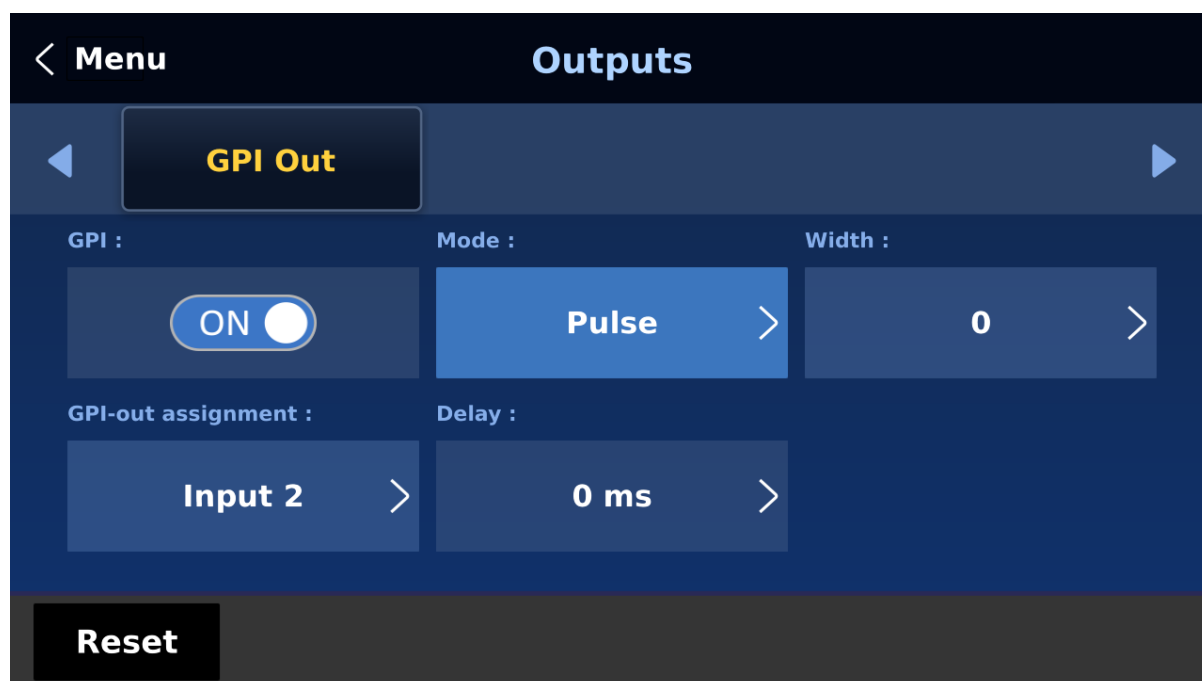

First enable the GPI port and then set the GPI **mode**, which is either level or pulse. The pulse width can be configured in **Width** sub-option (1-9).

Once the GPI function is enabled, you can assign it to one of **Inputs 1-8** which can later be used to trigger external devices and the **delay** can be set to a value between 0 and 99.

## **5.7 Audio**

In the **Audio** menu, you will be able to start and shut off the embedded audio of **SDI** and **HDMI** videos.

### **Audio**

External audio source can only enter the SE-4000 via the analog XLR input port found on the rear panel of the main unit. Ideally the user should use the SE-4000 with an audio mixer.

It is recommended to use AD-200 audio mixer designed and manufactured by Datavideo. All external audio sources can be connected to AD-200 before entering the SE-4000. The external audio can be embedded into SDI video out.

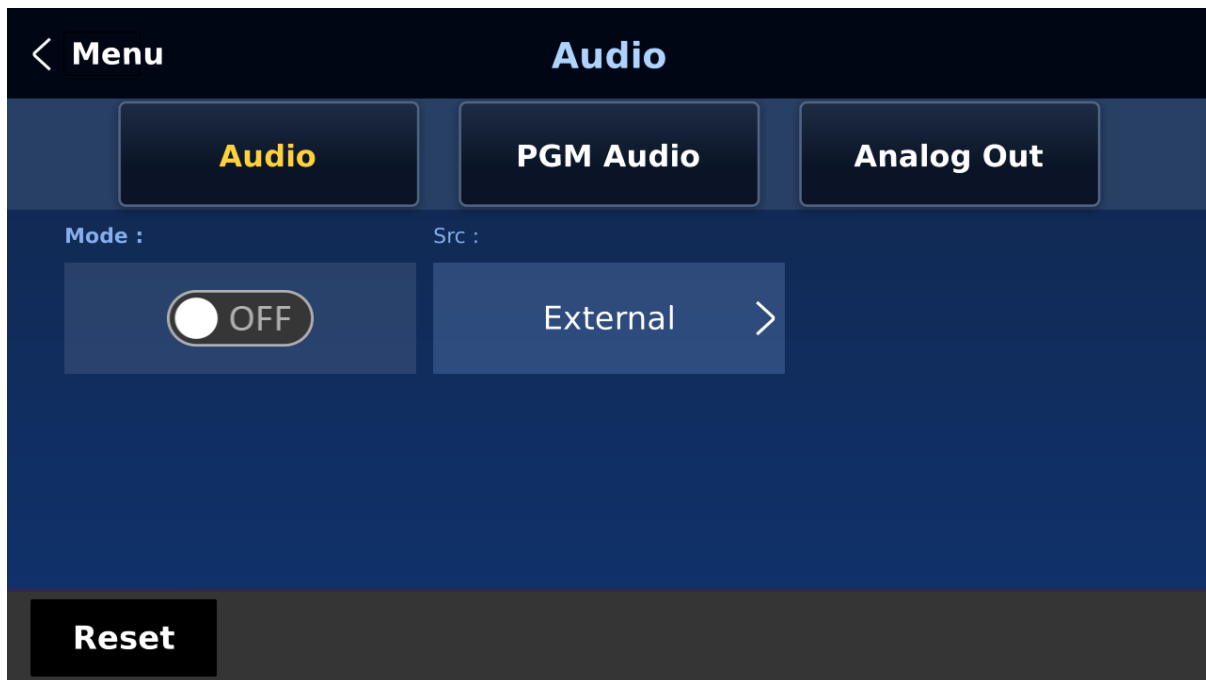

**Mode (ON/OFF):** Setting Mode ON allows the SE-4000 to embed external audio component into SDI video out. Changing the **Mode** option from ON to OFF will mute the embedded audio.

**Audio Src:** This sub-option allows the user to select the audio source.

If “**External**” is selected, the external audio, i.e. audio from **AUDIO IN** port, will be played.

If “**Follow**” is selected, the audio will enter Audio follow Video mode, i.e. playback of the audio of the output video.

To play the audio of a particular input video channel, select an **input number** from Input 1-8.

### ***PGM Audio***

In PGM Audio, you will be allowed to select the audio transition effect, and set the PGM audio volume and delay.

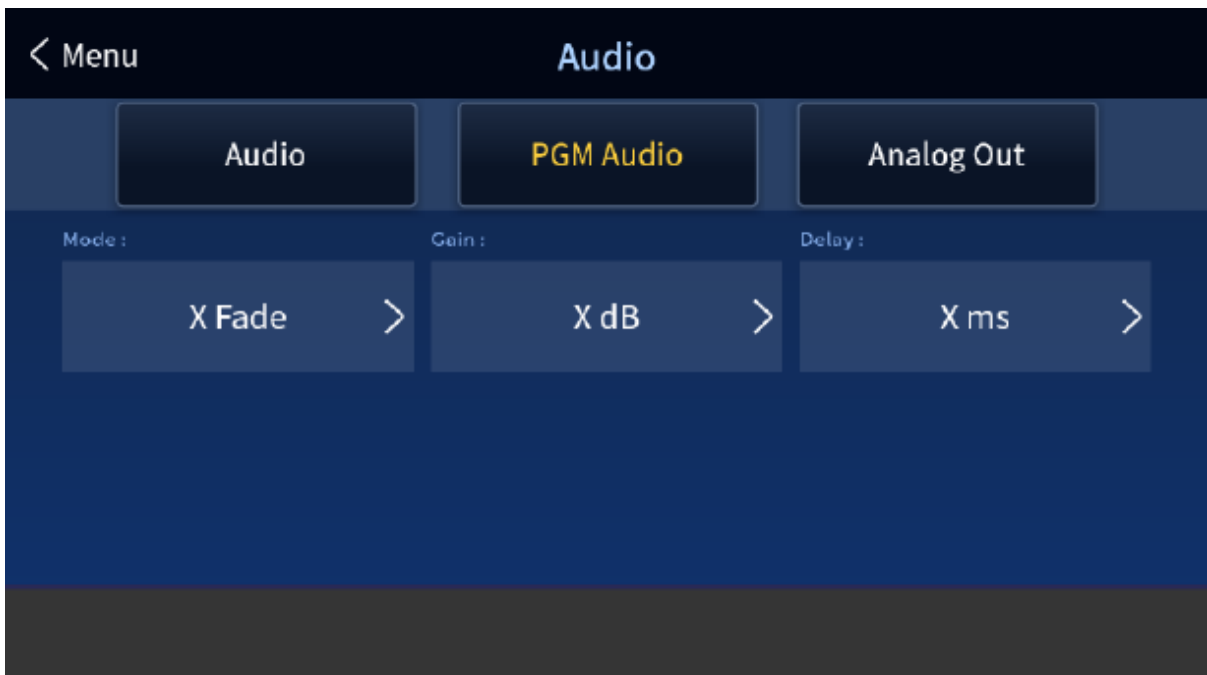

**Mode (V Fade/X Fade)**

While working in the Audio-F-Video mode, the audio sources will also change as the video sources are switched. We can choose how the audio changes sources, whether it be a clean cut (immediate switch) or some sort of transitioned change (cross fade or fade out & in). To do this we would need to set up with the following menu options.

- **X Fade:** PGM Audio / PVW Audio cross fade
- **V Fade:** Fade out PGM Audio then fade in PVW Audio

**Gain (-60 – 24 dB):** adjustment of the PGM audio volume.

**Delay (0 – 340 ms):** sets the PGM audio delay.

**Analog Out**

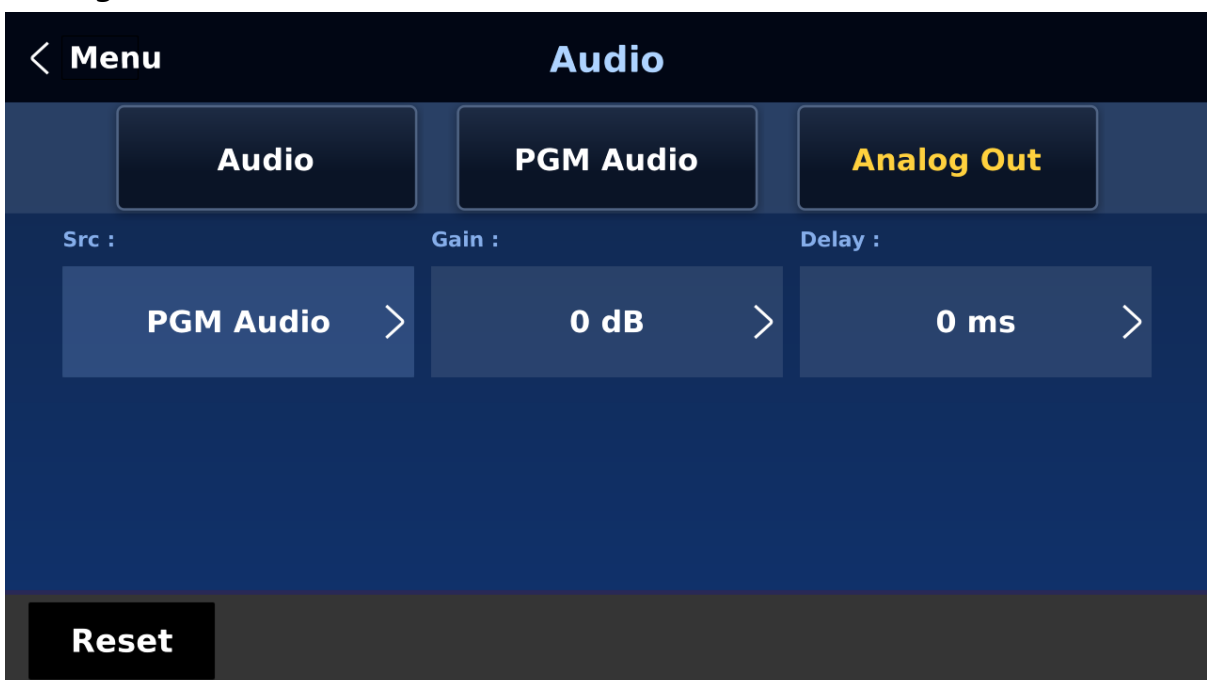



You are also allowed to select a source of audio of your preference and output the selected audio via Audio OUT. Open the GUI menu and select Audio → Analog Out → Src where you may select a source of audio from the following list.

- PGM Audio
- Follow
- Input 1-8

If “**Follow**” is selected, the audio will enter Audio follow Video mode, i.e. playback of the PGM audio via Audio OUT **without audio output delay**. If “**PGM Audio**” is selected, the SE-4000 will only play the PGM audio via Audio OUT **with audio output delay**. You may also select to output one audio component of the 8 inputs via Audio OUT **without audio output delay**.

**Gain (-60 – 24 dB):** adjustment of the audio volume at the **AUDIO OUT**.

**Delay (0 – 340 ms):** sets the delay of the audio at the **AUDIO OUT**.

## 5.8 Files

In Files, you will be allowed to manipulate different files such as clips, still pictures, user memories and still and animated logos.

**Still** allows the user to load images from the memory, save images to the memory, and save the images captured. **User** allows you to **load** previously saved settings and **save** the currently configured settings. In **Stinger**, you will be able to browse through the clip files and load the clips directly on the switcher. As for logo and ani logo menus, they allow you to load still and animated logos directly on the switcher.

All five file types will be discussed in the following sub-sections.

### ***User Mems***

In this option, the user is allowed to **load** previously saved settings and **save** the currently configured settings.

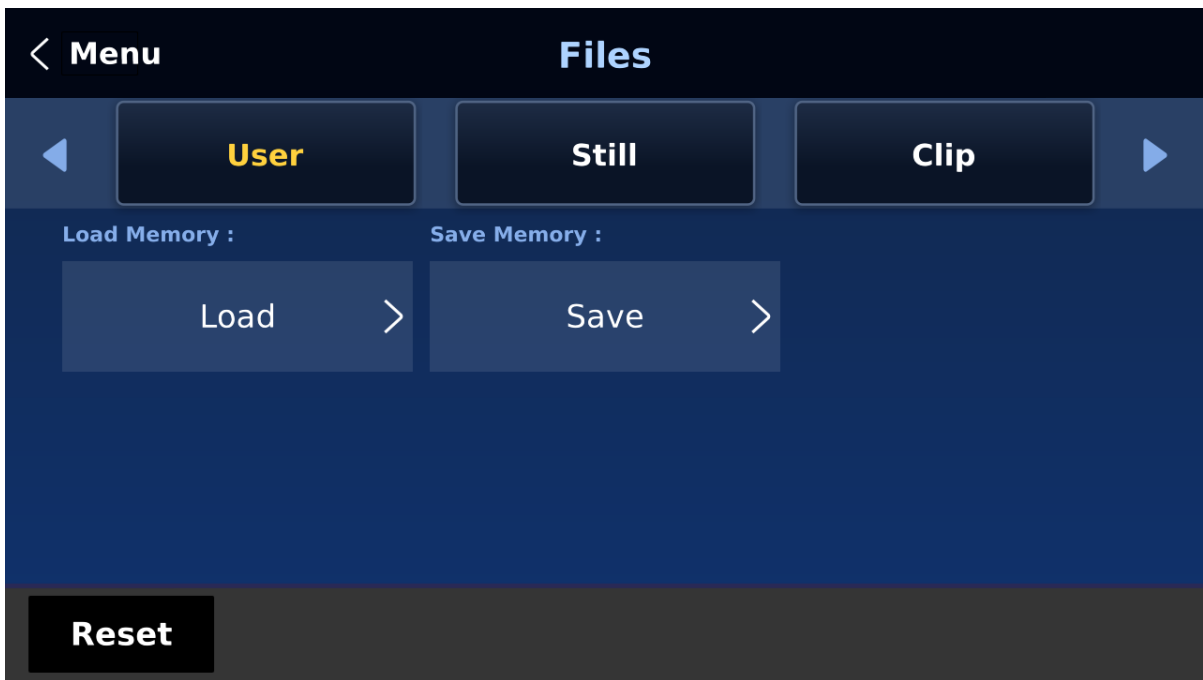

**Load Memory**

Tap to open a numeric keypad and enter a memory location. Click **OK** to load the saved setting.

**Save Memory**

Tap to open a numeric keypad and enter a memory location. Click **OK** to save the current setting.

**Still**

**STILL image** is an image pre-loaded to the SE-4000's input buffers (Input 1-8). The **Still** menu allows users to load still pictures from the machine's internal memory to the input buffer, save still pictures to the machine's internal memory, view thumbnail pictures and grab program image to the specified still memory locations.

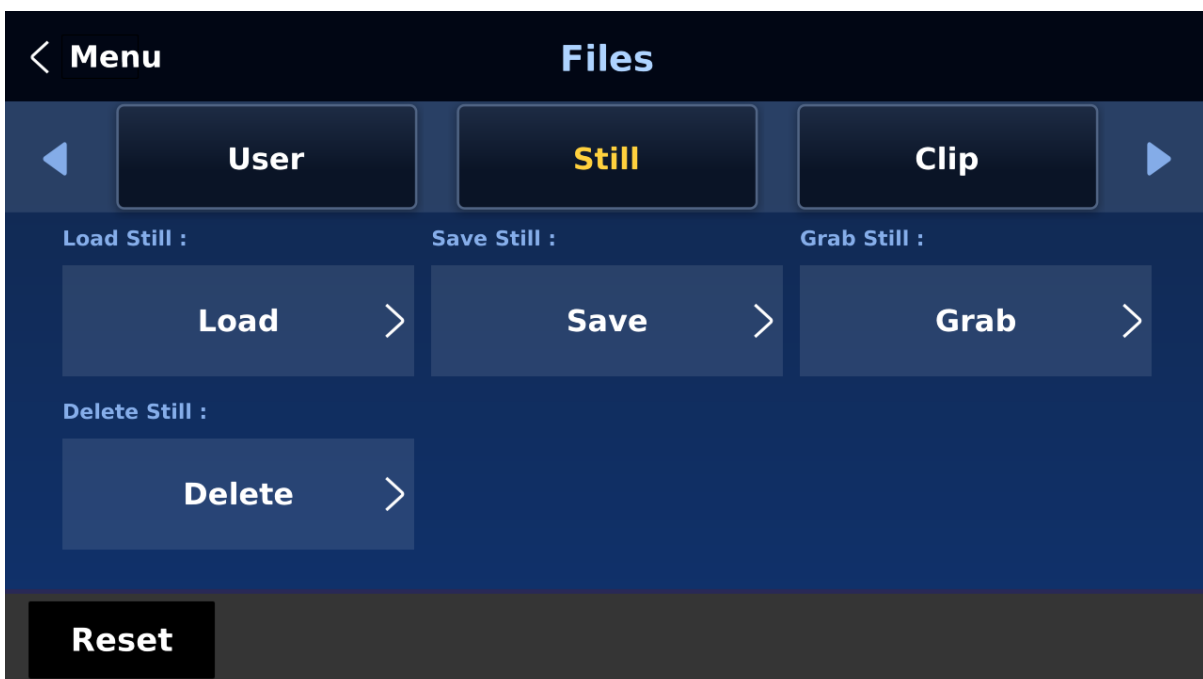

### Load Still

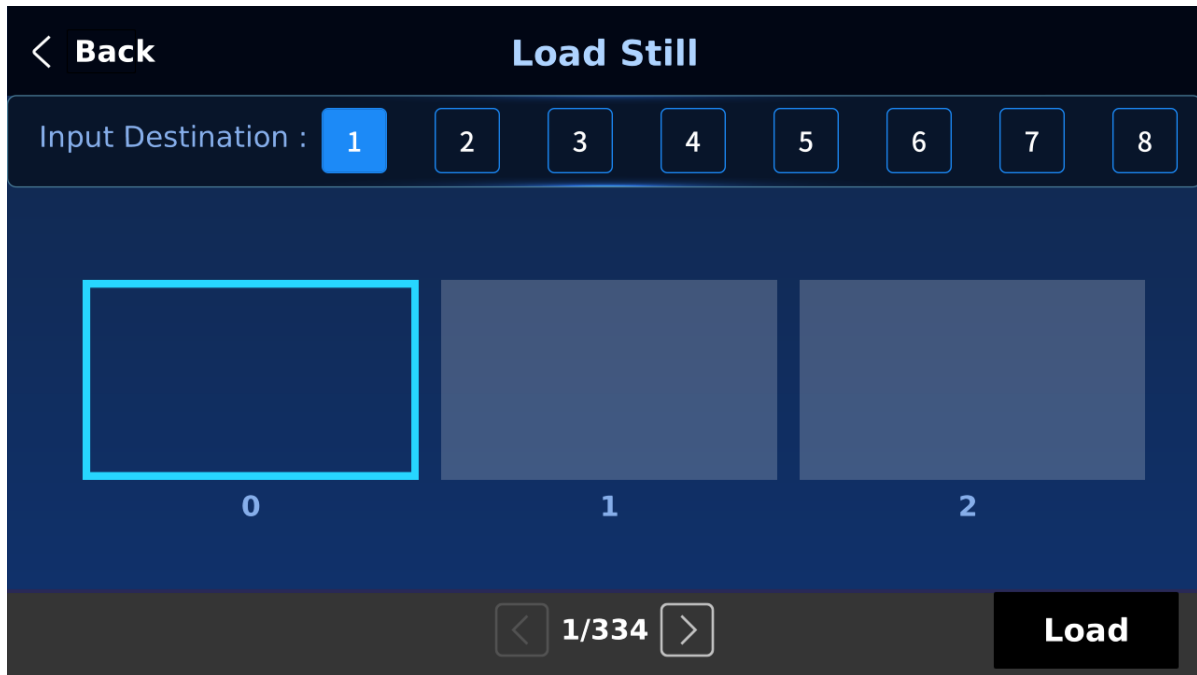

Upon selecting “**Load Still**”, the user can then choose the memory location from which the still image is loaded. The system memory can store up to 250 still images. The following are destinations to which the still image can be loaded:

- Inputs 1 – 8

Tap “**Load**” to load the still image to the chosen destination.

**Image Preview** is available as **thumbnail pictures**.

**Note: The user is allowed to import still picture files. It is recommended to use 24-bit without Alpha bmp, png and jpg formats.**

### Save Still

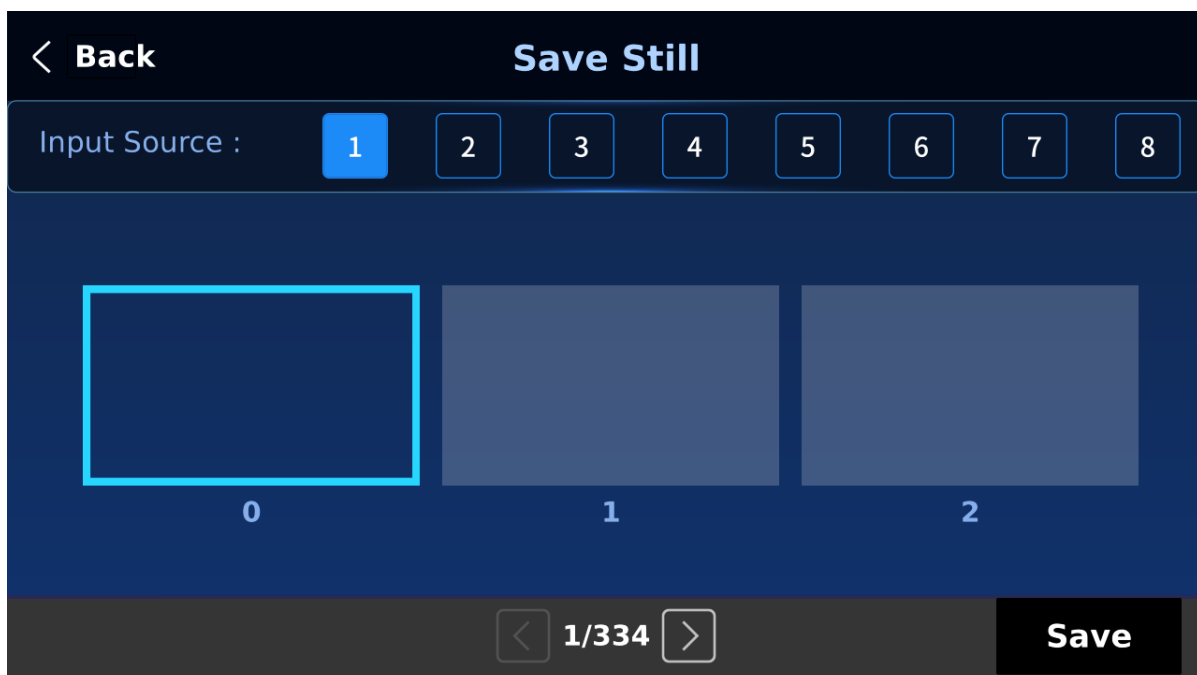

“**Save Still**” allows the user to save the still image to a specific memory location. The user should determine the source of the still image first. The available sources are listed below:

- Inputs 1 – 8

To complete the save, the user can simply tap “**Save**” after determining the memory location.

#### **Grab Still**



“**Grab Still**” function grabs an instant of the video image on the Program view to the destinations listed as follows:

- Still 1
- Still 2

After determining the destination to which an instant of the video image is captured, simply select “**Grab**” to trigger the image grab.

#### **Delete Still**

To remove a still from a memory location, simply select a memory location, and tap “**Delete**” then “**Yes**” to confirm the delete.

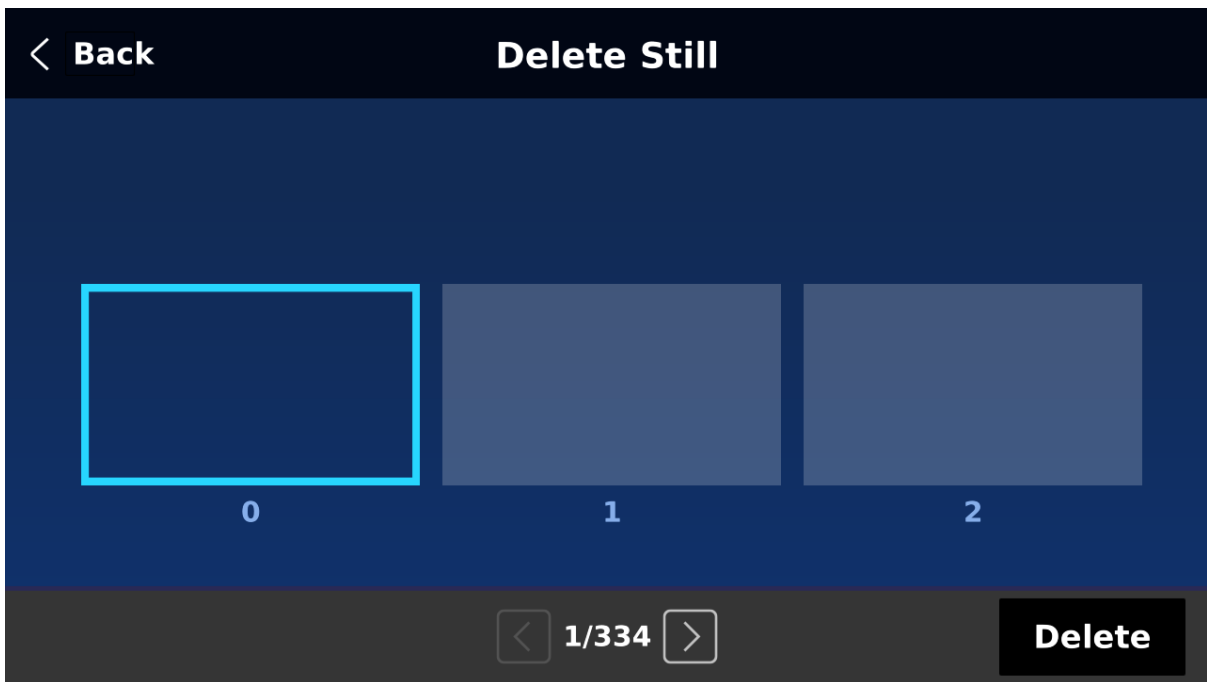

### **Loading still images**

The SE-4000 allows the user to load still images saved on the machine to the Multiview screen. Please follow the steps outlined below to load the still picture.

1. Press the **FILES** button to open the menu on the 5 inch touch screen.
2. Open the **Still** sub menu as shown below.

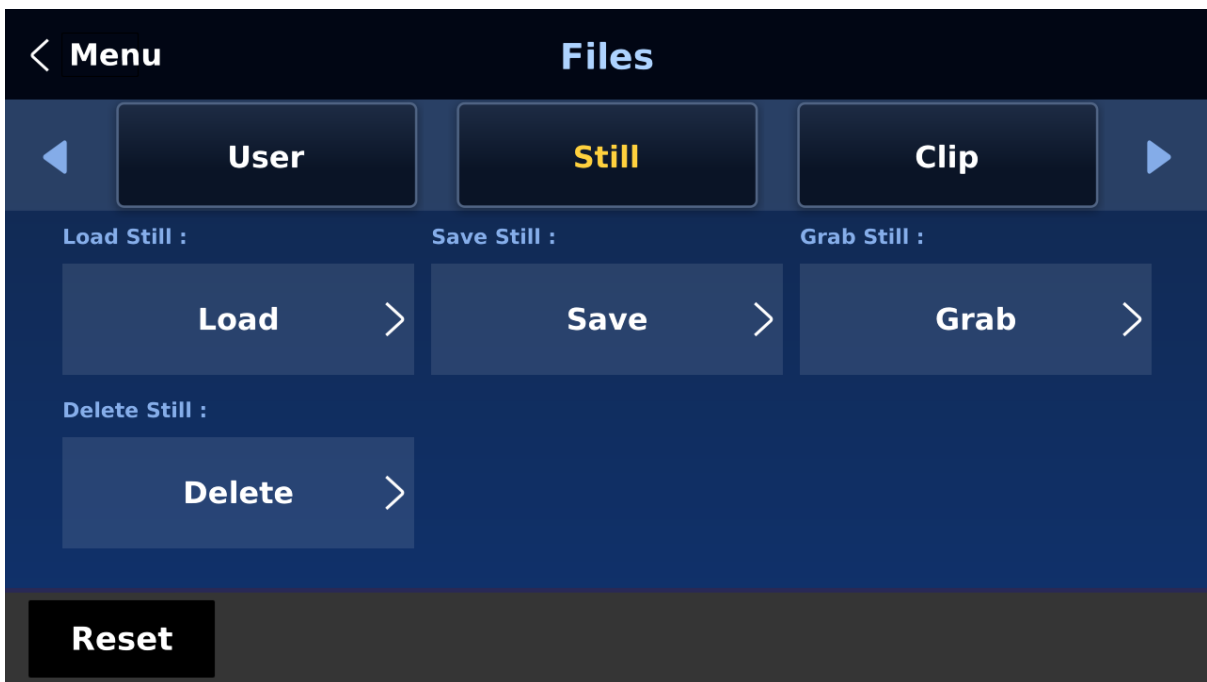

3. First select a destination to which the still picture will be loaded then the still picture. Lastly, tap **Load** to load the still picture to the selected destination.

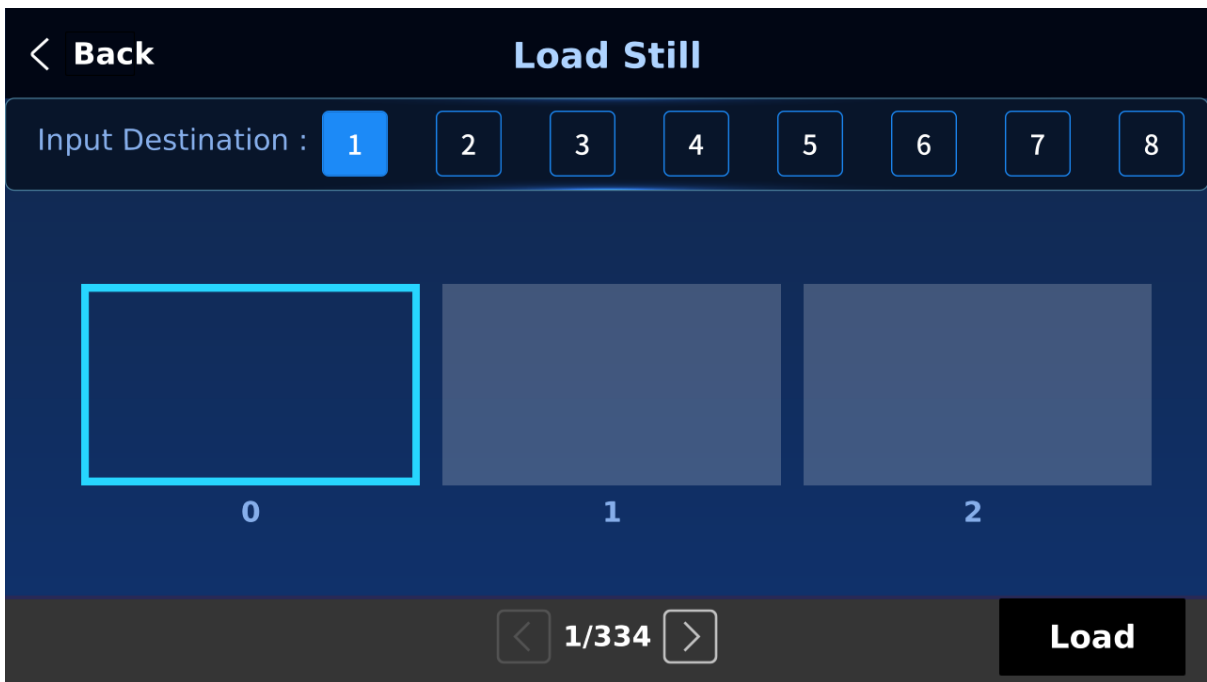

For more still functions such as file import from the PC or laptop, see [Section 6.3 Managing Still Pictures](#).

### **Stinger**

The **Stinger** Transition Effect is currently under development and will be added in future firmware upgrades.

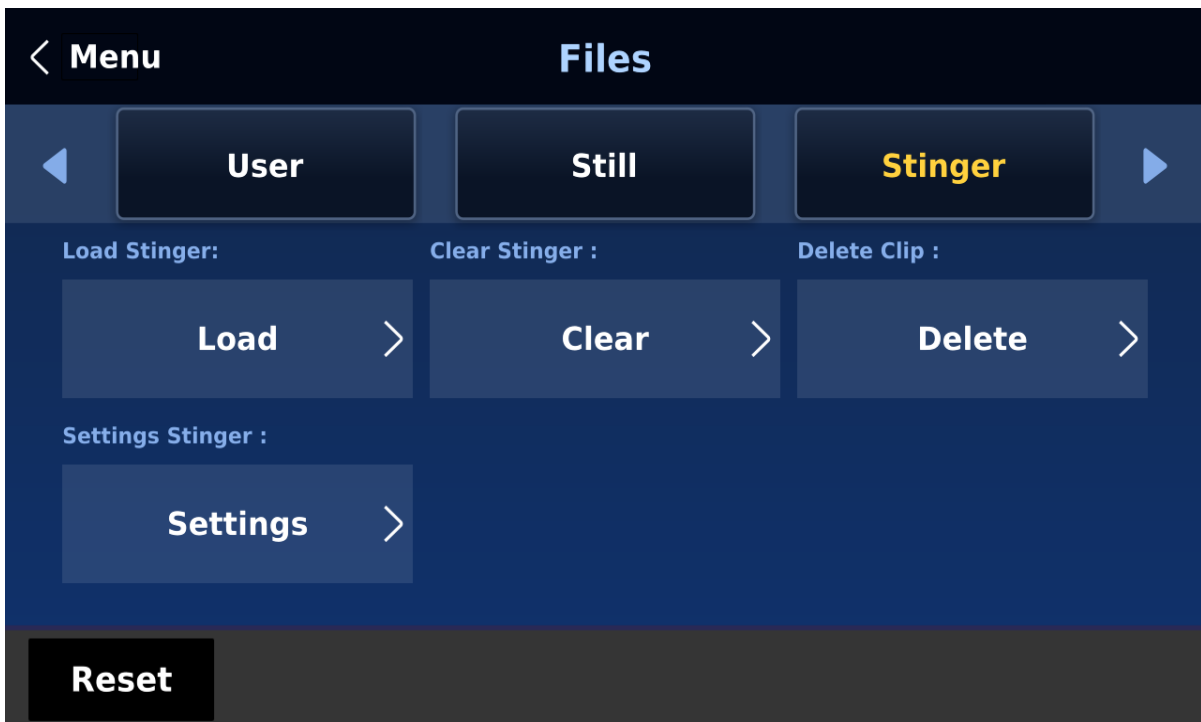

### **Logo**

Logo is a still image pre-loaded to the logo buffer (Logo 1/2). The **Logo** menu allows users to load logo pictures from the machine's internal memory to the logo buffer, save logo pictures

to the machine’s internal memory, view thumbnail logo pictures and adjust the logo positions.

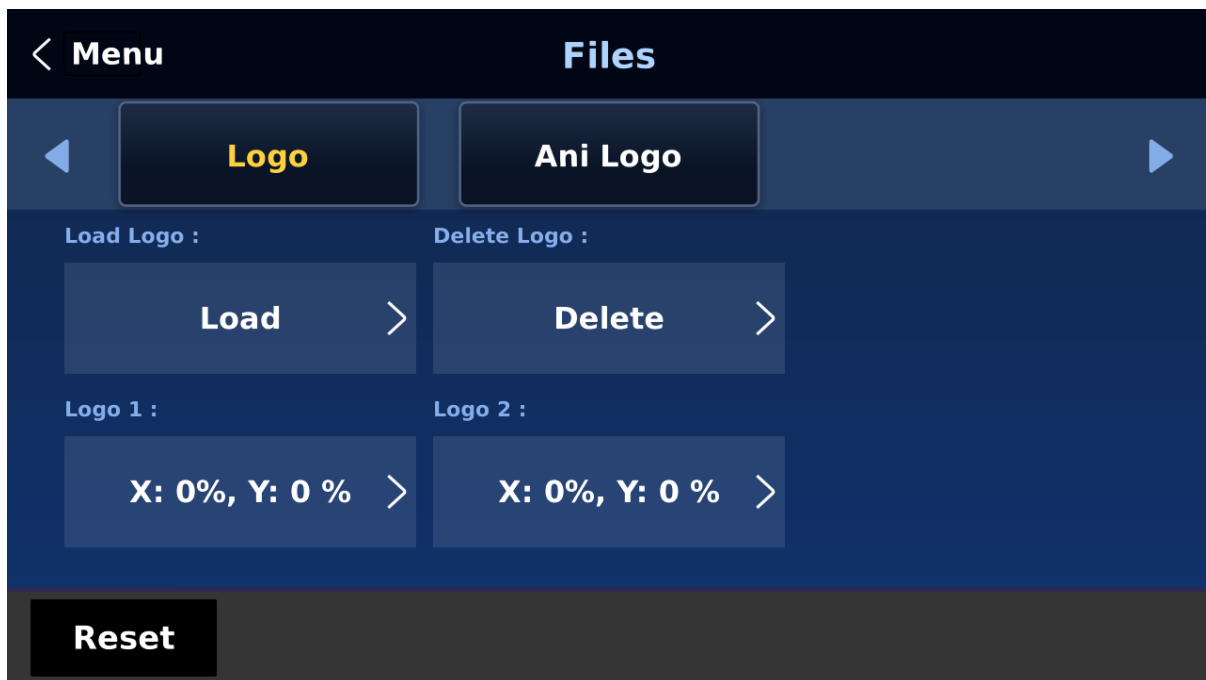

### ***Load Logo***

Upon selecting “**Load Logo**”, the user can then choose the memory location from which the still logo image is loaded. The system memory can store up to 250 still logo images.

Select “**Load**” to load the logo to the chosen destination (Logo 1/Logo 2).

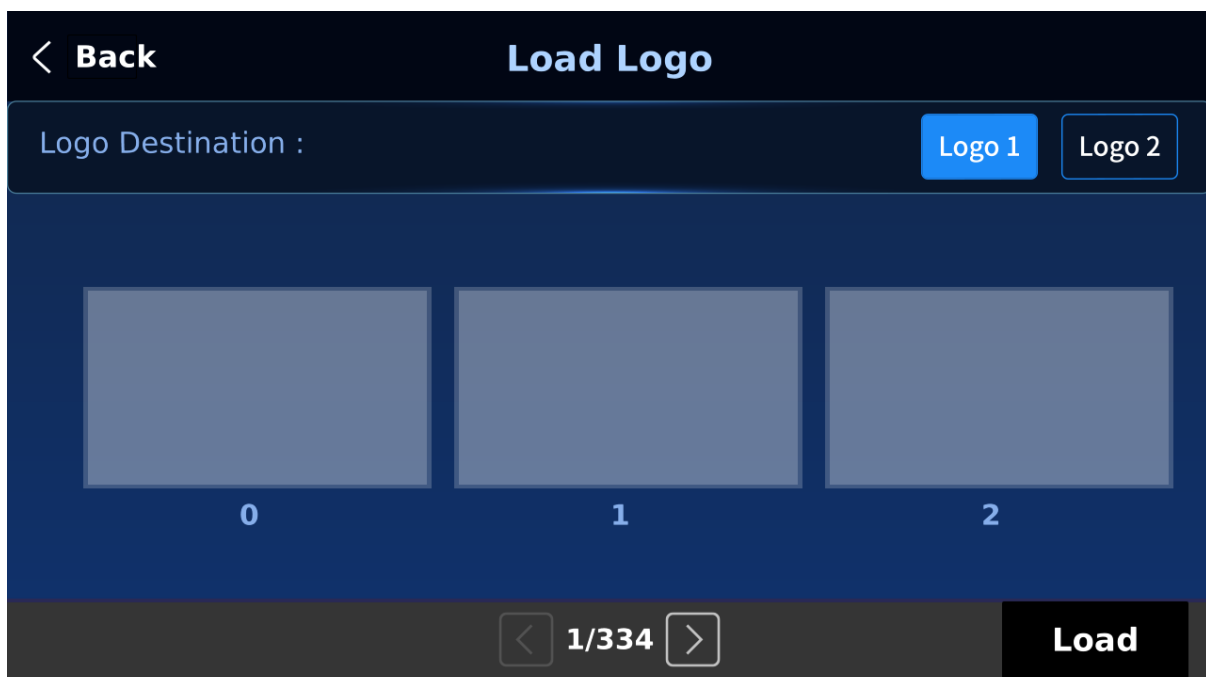

**Note:** To import custom logos from your computer, see [Section 6.4 Enabling Still Logo](#) for instructions.

### ***Clear Logo***

To clear the loaded logo from the buffer (Logo 1/2), simply select “**Clear Logo.**”

### **Delete Logo**

First move to a memory location, then select “Delete” to remove the still logo from the selected memory location.



### **Positioning**

The logo can be manually positioned by adjusting its XY coordinates. Note that the origin of the coordinate system is at the center of the screen.

**X:** A positive value indicates that the logo is in the right half of the screen and a negative value indicates that the logo is in the left half of the screen.

**Y:** A positive value indicates that the logo is in the top half of the screen and a negative value indicates that the logo is in the bottom half of the screen.

### **Ani Logo**

Ani Logo is an animated logo pre-loaded to the logo buffer (Logo 1/2). The **Ani Logo** menu allows users to load animated logo from the machine's internal memory to the logo buffer, save animated logo to the machine's internal memory, view thumbnail images and adjust logo position.



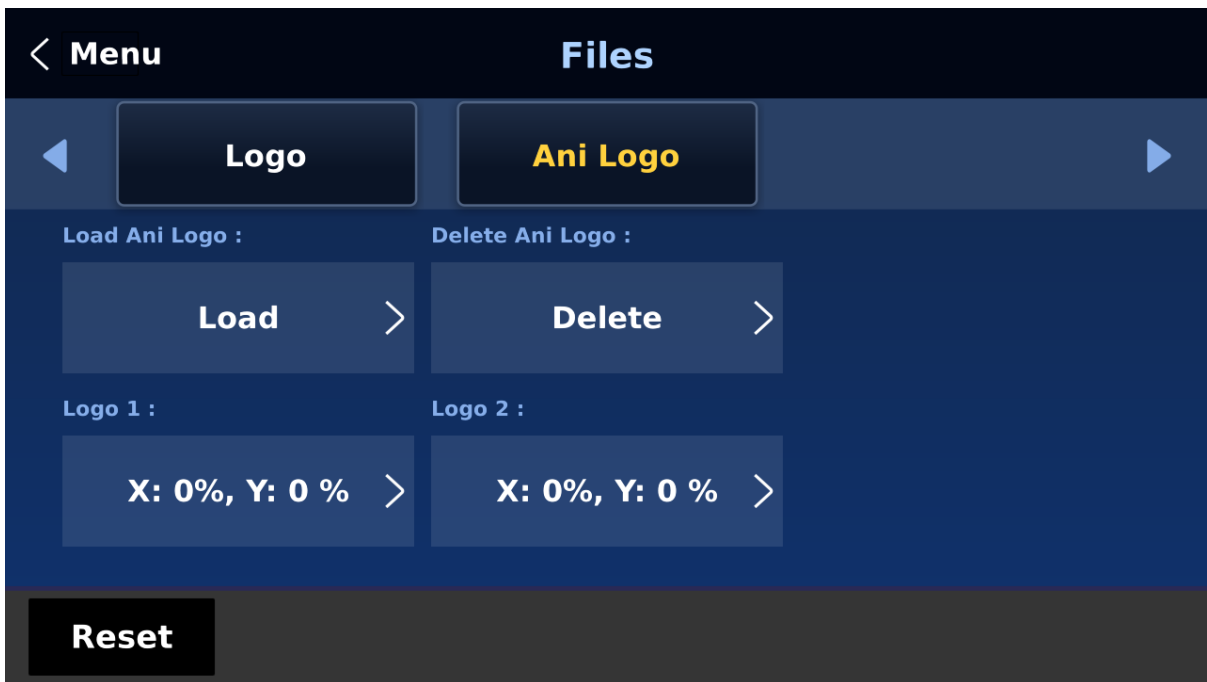

**Load Ani Logo**

Upon selecting “**Load Ani Logo**”, the user can then choose the memory location from which the animated logo is loaded. The system memory can store up to 250 logo animations.

Select “**Load**” to load the animated logo to the chosen destination (Logo 1/Logo 2).



**Note:** To import custom logo animations from your computer, see [Section 6.5 Enabling Logo Animation](#) for instructions.

**Clear Ani Logo**

To clear the loaded logo animation from the buffer (Logo 1/2), simply select “**Clear Ani Logo.**”

### Delete Ani Logo

First move to a memory location, then select “Delete” to remove the animated logo from the selected memory location.



### Positioning

The animated logo can be manually positioned by adjusting its XY coordinates. Note that the origin of the coordinate system is at the center of the screen.

**X:** A positive value indicates that the animated logo is in the right half of the screen and a negative value indicates that the animated logo is in the left half of the screen.

**Y:** A positive value indicates that the animated logo is in the top half of the screen and a negative value indicates that the animated logo is in the bottom half of the screen.

## 5.9 Setup

In the “Setup” menu, the user can change the **resolution**, reset the SE-4000 to its **Factory Default** values, enable/disable **Auto Save**, choose the preferred menu **language**, **upgrade firmware** and view the **current firmware versions** (Interface, Mainboard and Keyboard).

### Standard

This option allows the user to choose the appropriate output resolution. Once done, simply select “Save” to confirm the selected output resolution. The available resolutions are 4K/60/59.94/50/30/29.97/25 and 1080p/60/59.94/50/30/29.97/25.

**Note:** If you’ve selected 1080p for the output resolution, all inputs should have a resolution of 1080p as well.

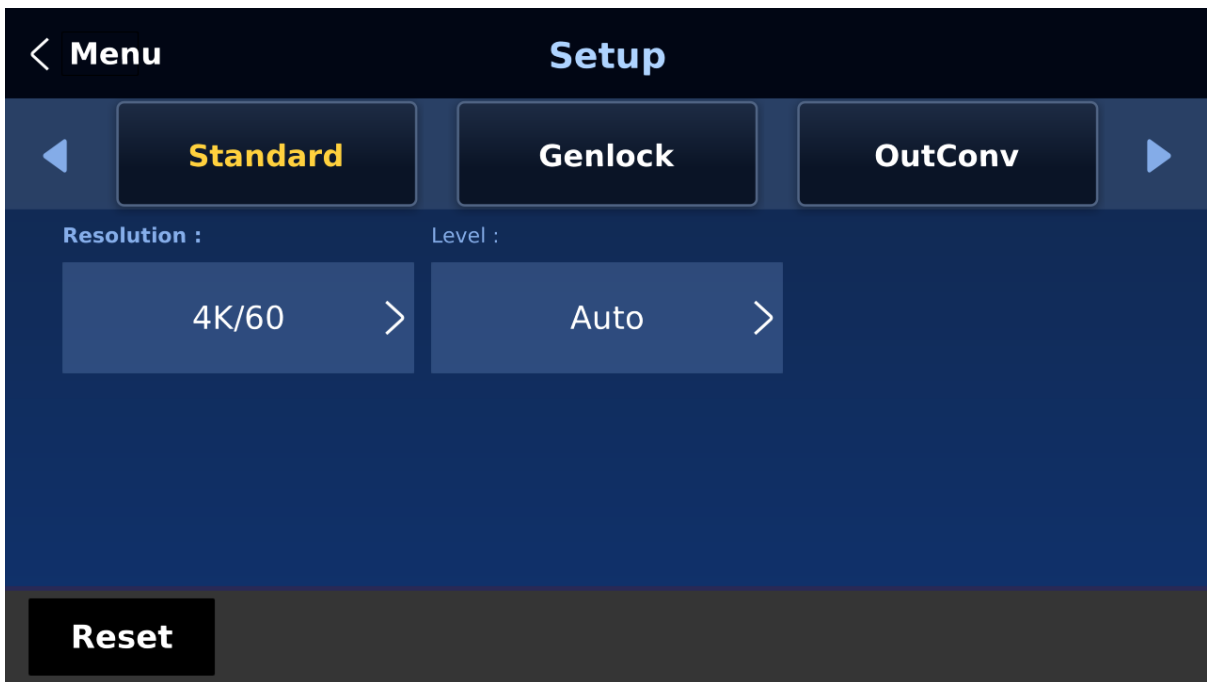

### Level

There are two different audio standards available for selection. The user can either select the EBU or SMPTE standard. By selecting AUTO allows the device to automatically detect the audio standard.

**Note:** When the image is 50 Hz, the audio follows EBU standard and when the image is 59.94/60 Hz, the audio follows SMPTE standard.

### Genlock

**Genlock** is an external sync setting. **Ref IN/OUT** port receives external sync which can either be **Tri-Level** or **Black Burst** signal. **Please note that resolutions of 1080i and 720p are not appropriate for Black Burst Sync.**

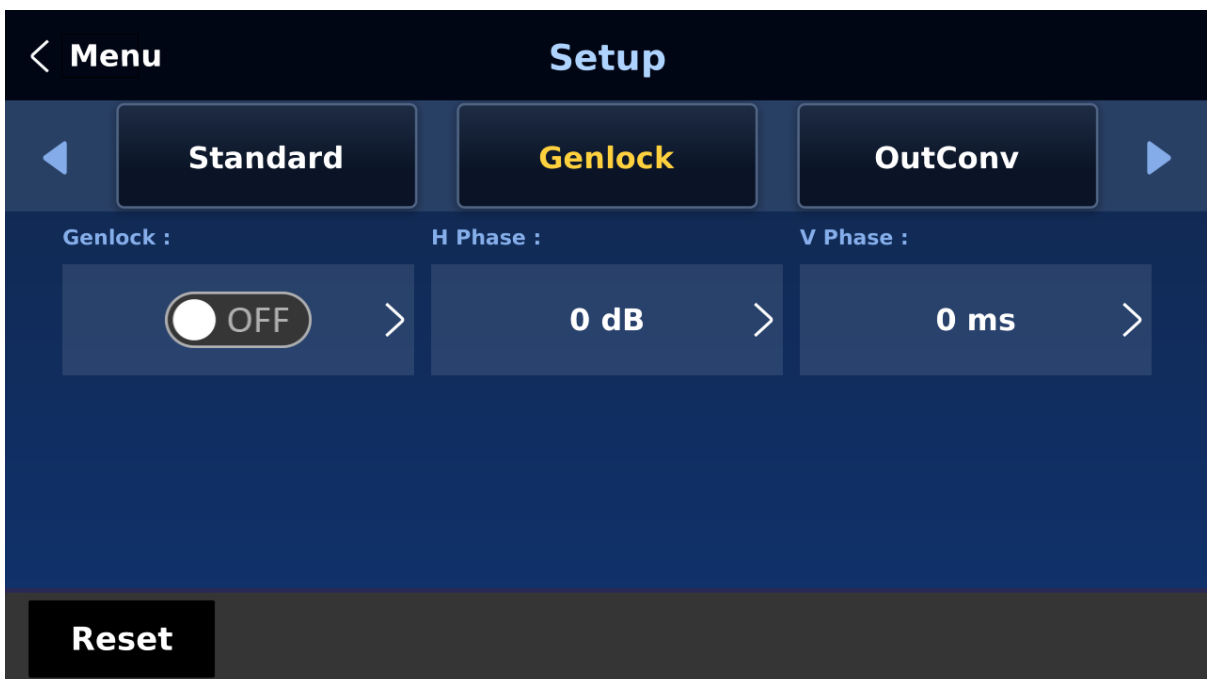

The genlock function is currently under development and will be added in future firmware upgrades.

### **Keyboard**

In **Keyboard**, you will be allowed to adjust the keyboard brightness with 7 being the brightest and 1 being the dimmest.

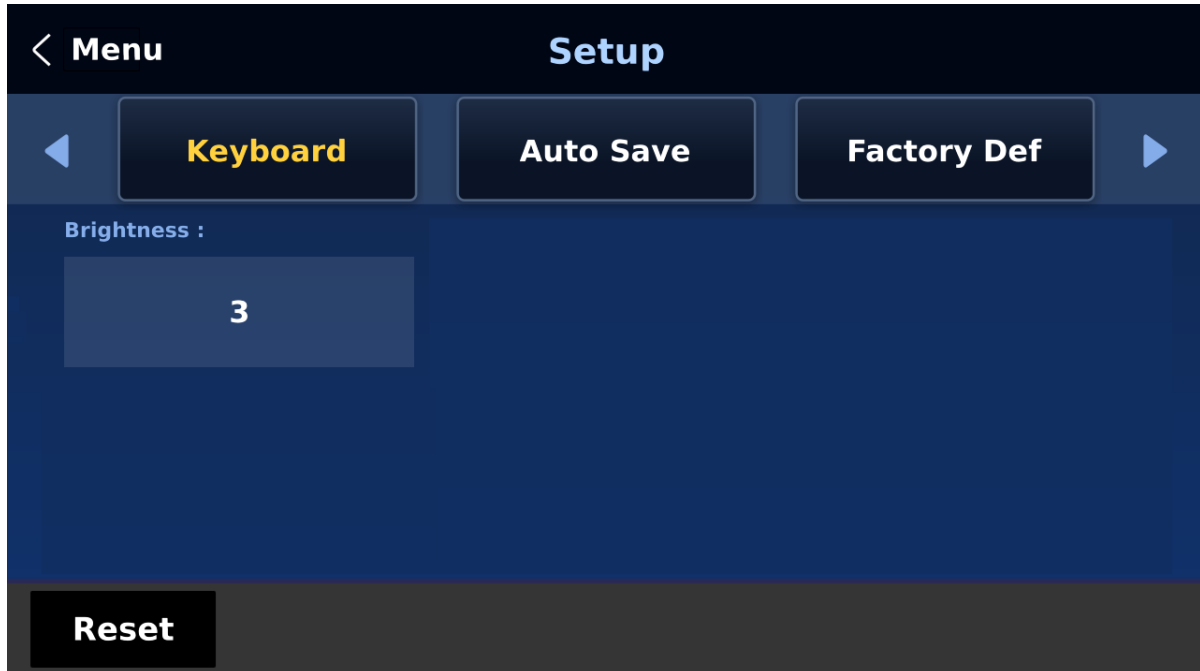

### **Auto Save**

When enabled, your last settings will be automatically saved within 5-10 seconds after exiting the GUI menu. Do not shut down your machine during this time. At the next boot, the machine will automatically load the last saved settings. Note that **Still Load** also triggers auto save.

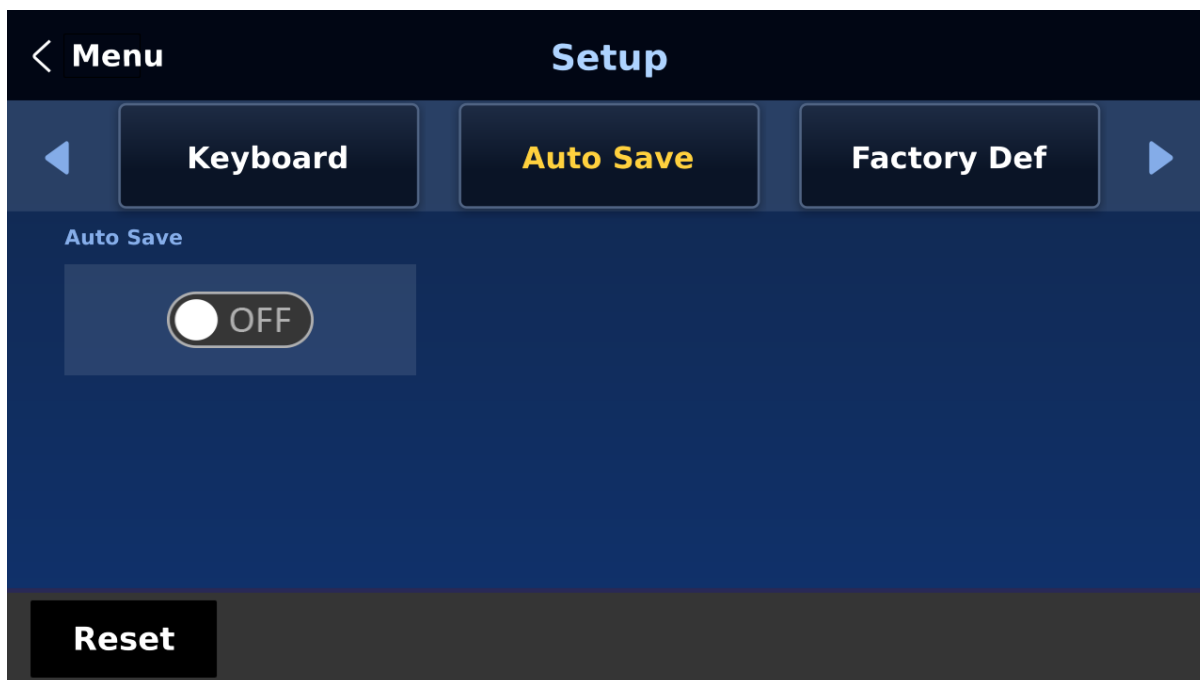

Note: The **Auto Save** function does not instantly save new settings; it is only triggered 5 to 10 seconds after exiting the GUI menu. This is to avoid adverse effects on the smoothness of operation.

The **Auto Save** function does not apply to the resolution setting. To change the SE-4000's resolution, go to "**GUI Menu/Setup/Standard**" and then select "Save Setup" to save the new resolution setting.

### **Factory Def**

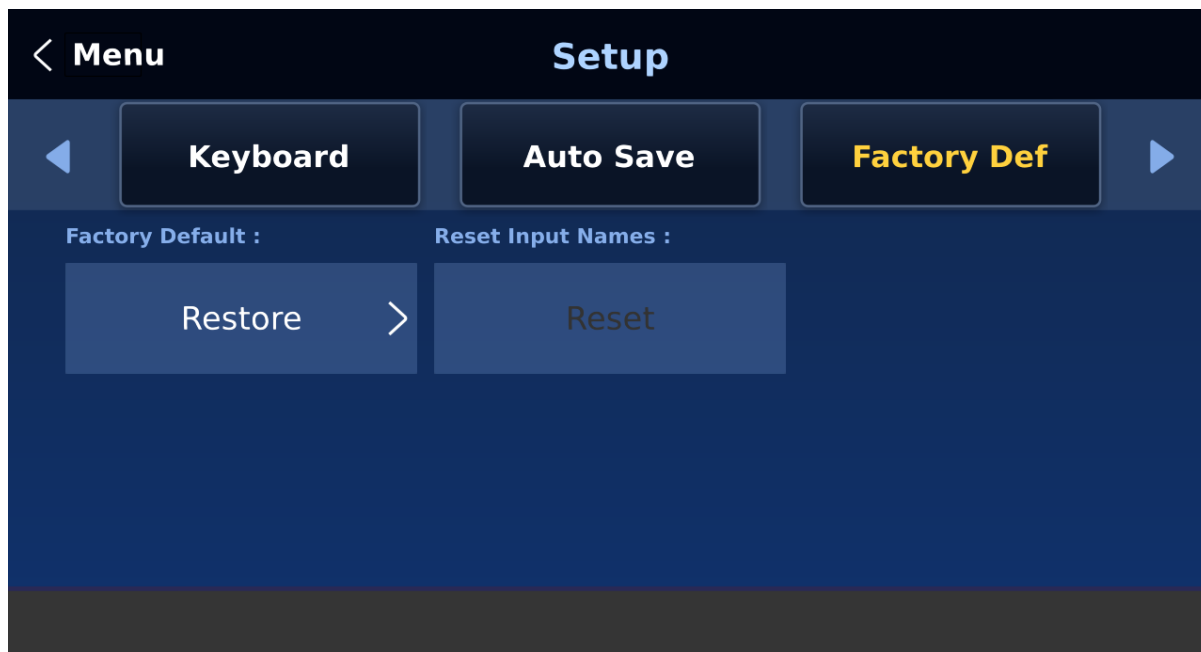

**Factory Default:** Tap Restore to reset the machine to factory default settings.

**Reset Input Names:** Tap Reset to reset the Multiviewer labels (Input 1-8).

### **Language**

The available GUI languages are English, Traditional Chinese and Simplified Chinese.



## Network

The Network sub menu allows you to view and set the IP addresses of the switcher's main unit and control panel. See [Section 2.2](#) for network setup.

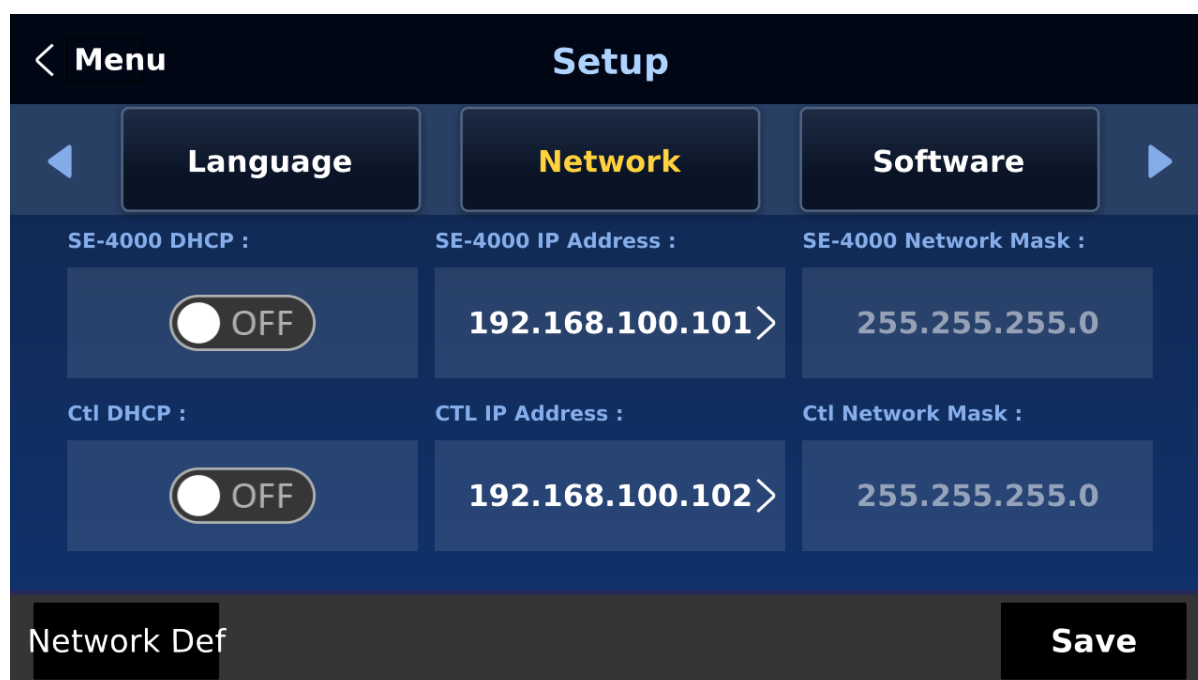

SE-4000 and CTL refer to the switcher's main unit and control panel respectively.

**DHCP:** The available network connection modes are **DHCP** and **Static**. The default connection mode is **Static** (DHCP turned off). The default IP addresses of the main unit and the control panel are **192.168.100.101** and **192.168.100.102** respectively.

**IP Address:** Tap to open a numeric keypad then manually enter the IP address if **DHCP** is turned off (Static IP mode).

**Network Mask:** Tap to open a numeric keypad then manually enter the network mask if **DHCP** is turned off.

On the numeric keypad, select Cancel to close the keypad without saving the changes made and OK to save the IP address entered.

**Network Def: resets network settings to factory defaults. Default settings are listed below.**

- DHCP: Off
- IP Address: 192.168.100.101 (SE-4000) and 192.168.100.102 (CTL)
- Network Mask: 255.255.255.0

Once all settings are entered, tap Save to save all changes made and reboot the device to apply the new network settings.

Please note that, on the main unit, you can also use a needle to push the reset hole next to the DVIP port to restore the default IP address. Push the reset button then hold for about 5 to 10 seconds until the machine reboots itself to restore the IP address to 192.168.100.101.

## Software

This Software sub menu allows the user to perform a firmware upgrade when the USB storage device containing the latest firmware file is inserted. Tap **Upgrade** to start the firmware upgrade process. Refer to the [FIRMWARE UPGRADE](#) section for more details. You can also view version numbers of various software.



## Chapter 6 Basic Operation

The switcher's control panel is the main control interface for the user to select video sources and take them to air during live production. On the control panel, the user will be allowed to select the transition style, enable/disable various keyers, and add logos to the program view.

The GUI allows the user to adjust transition settings, configure chroma keyers and PIP windows, assign inputs and outputs and modify audio parameters.

This chapter describes how you can switch video sources on the control panel using simple operations.

### 6.1 Video Switching

First let's learn the basics of video switching.

#### *Program and Preview rows*

The Program row of buttons is typically used to select the switcher's main Program output image. The selected source sent to the Program outputs will be **backlit Red** on this row. Simple cuts between sources can be performed on this row by pressing the source number required for the next shot.

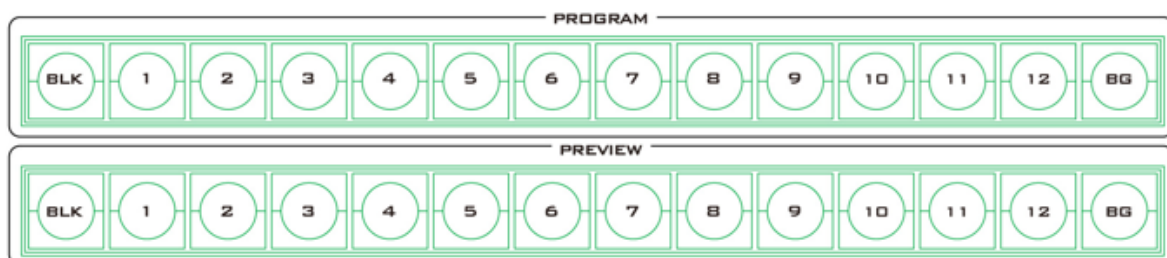

The Preview row of buttons is typically used to select the switcher's Preview or Next source output image. The selected source will be **backlit Green** on this row. You can transition between Preview and Program using the **T-Bar**, the **CUT** button or the **AUTO** button.

**Note: The keys on the Program and Preview rows will still be active while the T-Bar is moving.**

#### *Source Row*

The SE-4000 allows you to simultaneously activate 8 live channels out of the available 12 input channels. As a result, channels 3/4/7/8 are designed to be shared channels, allowing you to switch between SDI and HDMI input ports (see the input video port labels at the rear of the main processing unit). In addition, you can also customize the output channels.

Use the Source row of buttons to switch between SDI and HDMI interfaces for shared input channels 3/4/7/8. You can also assign different video sources to the output channels by making a selection along the Source row of buttons.

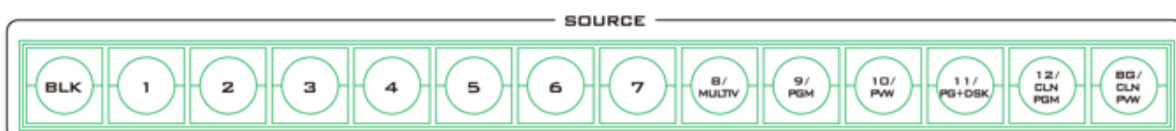



The Source row of buttons must be used with the SHIFT and AUX buttons. See the following for detailed descriptions.

Follow the steps below to switch the input interface for the shared channels:



1. Press the **SHIFT** button, buttons 3/4/7/8 along the Source row should illuminate.

2. Press one of the illuminated buttons (3/4/7/8) to switch between SDI (Green) and HDMI (Blue) interfaces.

3. Press the **SHIFT** button again to exit.

Follow the steps below to customize the output channels:



1. Press the AUX button to start assigning your output videos.

2. Buttons 1-7 of the Preview row should turn green and they correspond to SDI outputs 1 – 4 and HDMI outputs 1 – 3. The selected channel should turn blinking green.

3. The blinking blue button along the Source row indicates the video source selected for the corresponding SDI or HDMI output. To change to another video source, simply press the corresponding button.

4. For composite buttons, press the BLK button to switch to another set of alternative video sources.

5. Push the AUX button again to exit.

### ***Black and Background MATTE View***



The **BLK/BG** button allows the user to switch between a black background, and a matte colour on Program and Preview screens.

The MATTE color can be configured in the GUI menu. Simply go to 'Start' → 'Matte' and then adjust **Luma**, **Saturation** and **Hue**.

For **Hue** value, **Red** is 0, **Green** is approximately 120 and **Blue** is approximately 240. For secondary colors, **Yellow** is approximately 60, **Cyan** is approximately 180 and **Violet** is approximately 300.

The **Sat** or **Saturation value** refers to the intensity of the color selected in **Hue**. As the saturation increases, the color appears to be more pure. As the saturation decreases, the color appears to be more washed-out or pale.

The **Luma value** relates to how bright or dark the selected color or hue is. The higher the **Luma** value, the brighter the color selected in **Hue**.

## **6.2 Transitions**

The **Transitions** group of buttons allows the user to decide how to bring the selected Preview / Next source image to the Program output. The SE-4000 user can decide to use a **CUT**, **MIX**, **WIPE** or **Stinger (Animated Effect)** transition.

**Note: The Stinger transition is currently under development so the function cannot be used.**

### **CUT Button**



The **CUT** button is used to immediately switch between the currently selected Program and Preview sources.

### **MIX Button**



The **MIX** button is selected when a dissolve or fade transition between the selected Program and Preview sources is required. This **MIX** transition is produced by then moving the **T-Bar** manually or by pressing the **AUTO TRANS** button. To configure the mix transition time, open the GUI, then the **Start** menu, and modify the **M/E** value in the **Transition** sub menu accordingly.

**Program View  
Before Transition**



**Transition in Progress  
(MIX Effect)**

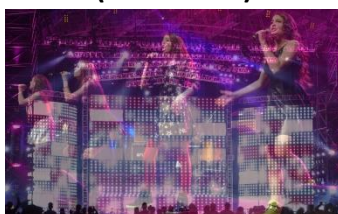

**Program View  
After Transition**



### **WIPE Button**



The **WIPE** button is selected when a 2D wipe transition between the selected Program and Preview sources is required. This **WIPE** transition effect is produced by then moving the **T-Bar** manually or by pressing the **AUTO** button. Follow the menu path **GUI menu** → **Start** → **WIPE Effects** → **WIPE** to select the 2D **WIPE** style.

**Program View  
Before Transition**



**Transition in Progress  
(WIPE Effect)**



**Program View  
After Transition**



### **Stinger Button**



Press the **Stinger** button to enable the Stinger transition mode.

The Stinger Transition Effect is basically an animated effect added during transition of two video sources. The animated effect is generated by a clip file which consists of a series of sequential files in **bmp/jpg/png/pic** formats. The Stinger transition is produced by then moving the **T-Bar** manually or by pressing the **AUTO** button.

**Note: The Stinger transition is currently under development so the button cannot be used.**

## **FTB Button**



The **FTB** button (Fade To Black) fades the current video program source to black. When pressed again it acts in reverse from complete black to the currently selected program video source. To set the transition time, open the GUI menu, then the **Start** menu, and modify the FTB value accordingly.

## **T-Bar**

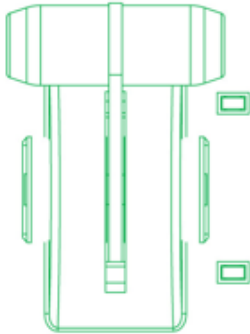

This performs a manually controlled transition from the current program source to the selected preview source. The selected transition wipe, dissolve or animation will be used. When the **T-Bar** has travelled as far as it can go, the transition between sources is complete. Please note that the **T-Bar** can be operated bi-directionally.

The **T-Bar** has indicators next to it, which light when the transition is in progress indicating the direction of operation and is off after the transition is complete.

You may want to re-calibrate the T-Bar if you find it working incorrectly. See the section on [T-Bar Calibration](#) for instructions.

## **AUTO Button**



The **AUTO** button can sometimes be used instead of the manually operated **T-Bar** to automatically perform the complete selected transition between Program and Preview over a set period. The **M/E** value in the **START** menu is used here. See [Section 5.1](#) for setting the M/E value.

## **Trans BG**



Turning on the Trans BG button allows you to activate the MIX, WIPE or Stinger transition with the background image/video. When on (backlit red), the background image/video will be included in any chosen transition from Preview to Program. When this button is toggled, or switched off, any Keyer transition chosen will not change the background Program image/video.

## **Trans PVW**



It is possible to see or test the effect of a chosen **MIX**, **WIPE** or **Stinger** transition on the Preview Monitor before using it on the Program output. Once the **TRANS PVW** button is ON, select and use the transition that you want to test on the Preview monitor. You will also notice that the Preview Monitor switches to the currently selected Program source when the **TRANS PVW** button is turned on. Do not worry, the chosen Preview source has not changed. Press the **AUTO** button or move the **T-Bar** manually to preview the chosen transition.

**NOTE: Remember to turn off the TRANS PVW button** before attempting to use the chosen transition on the Program output.

## WIPE Selection MENU

There are 32 different 2D WIPE effects to choose from when using the SE-4000 switcher. To select a different WIPE transition select a WIPE style in the **Start** Item of the GUI Menu (see the table below). Before you make the selection, make sure the **TRANS BG** and **WIPE** buttons are enabled.

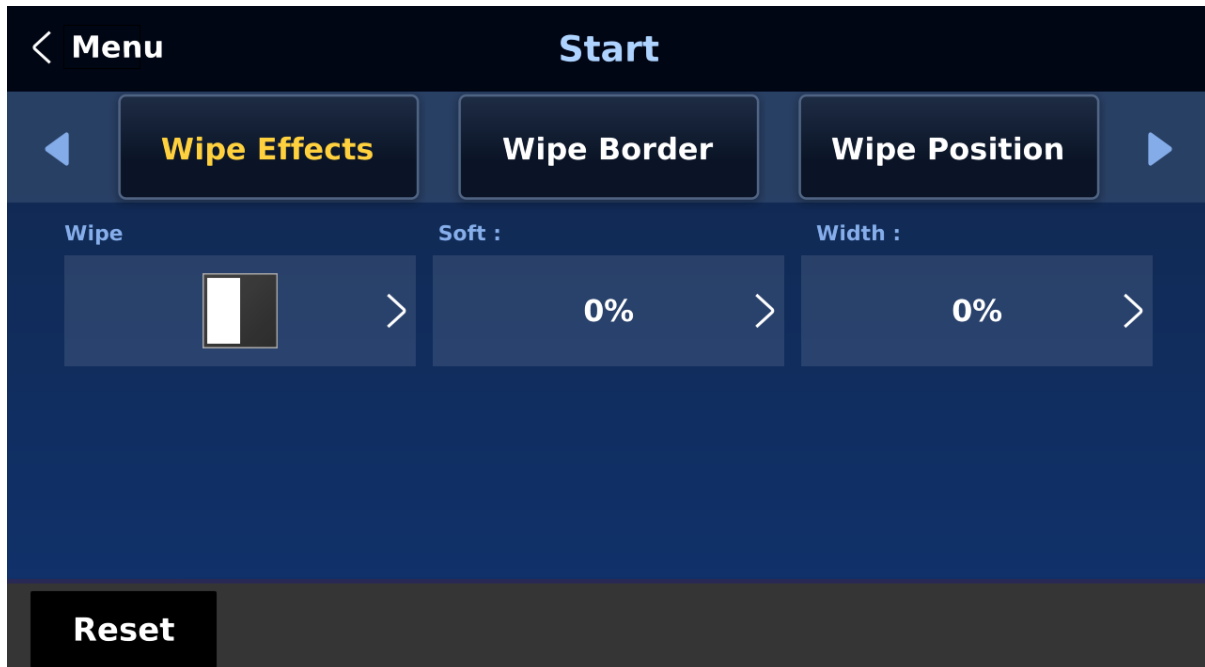

**Note:** Open the **GUI menu** by pressing the **HOME** button in the **MENU** area of the SE-4000 Control Panel.

To select a **WIPE** on the **GUI menu**, navigate to the **WIPE** option under **WIPE EFFECTS** and then select a **WIPE number**. Each WIPE transition also has flexible user options to tailor the look of the transition. All wipes have an optional colour border applied. The wipe border **width** and **colour** are also chosen within the menu system.

### Soft Value

This value allows the 'inside' and 'outside' edge softness of the Wipe Border to be controlled. A low value makes a sharp or hard wipe edge. A large value results in a softer or diffused wipe edge.

### Width Value

This value determines how wide the actual wipe effect is. A low value makes a narrow wipe. A large value makes a wider wipe.

### Hue, Sat and Luma values

The colour of the Wipe Border Matte can also be controlled by adjusting the **Hue**, **Sat** and **Luma** values.

### Wipe Position

Certain Wipes, such as the **Circle** and the **Oval Wipes**, allow the Wipe position to be controlled.

- The **X value** allows the selected wipe to be offset to the left or right of the screen.
- The **Y value** allows the selected wipe to be offset to the top or bottom of the screen.

## 6.3 Managing Still Pictures

On the SE-4000 Switcher, the user will be allowed to manipulate uncompressed still pictures with Grab and Frame Store functions. In this section, you will also be guided to load the stills saved on the switcher and display them on the monitor.

Each video channel of the SE-4000 has one frame store to which a still can be loaded, and the unit has enough storage space for up to 250 uncompressed stills.

### ***Grabbing & Saving a Still to Memory***

The function is currently under development.

### ***Loading an existing Still from Memory***

The function is currently under development.

### ***Deleting a saved Still from Memory***

The function is currently under development.

### ***FS – Frame Store Button***



The SE-4000 has eight video channels and each of these channels has its own Frame Store, making a total of eight Frame Stores. Each of these Frame Stores can hold one still image. The FS button allows the user to call the still image into the production and toggle between that still image of the Frame Store and the live video input connected to that same video channel.

### **How to choose live video input or Frame Store**

1. First press and hold down the FS button. The Preview row of input sources will flash green.
2. While still holding down the FS button, press the required input on the Preview row. For example, pressing button 1 switches the video channel to the still picture mode.
3. To return to the live video mode, simply press the channel button again.

This selection will also be confirmed on the Multi-view output, with the selected channel showing the live input or frame store image.

**Note:** Before using the FS function, first make sure the still picture has been loaded to the input video channel. Refer to [Section 5.8](#) for instructions on loading still pictures.

## 6.4 Enabling Still Logo

The SE-4000's logo function places a logo layer on your video. In this section, we will show you how to import still logo image to the switcher, load still logo image on the switcher as well as enabling the loaded still logo on Preview and Program Out.

The SE-4000 has enough storage space for up to 250 uncompressed still logo pictures.

## Loading an existing Logo from Memory

The SE-4000 allows the user to load still logo from the machine's memory to the logo buffer (Logo 1 or 2), then press either Logo 1 or Logo 2 button to enable the loaded logo on both the Preview and Program Out. Follow the steps outlined below to load the desired still logo from memory.

1. Open the still logo sub menu in the Files menu.

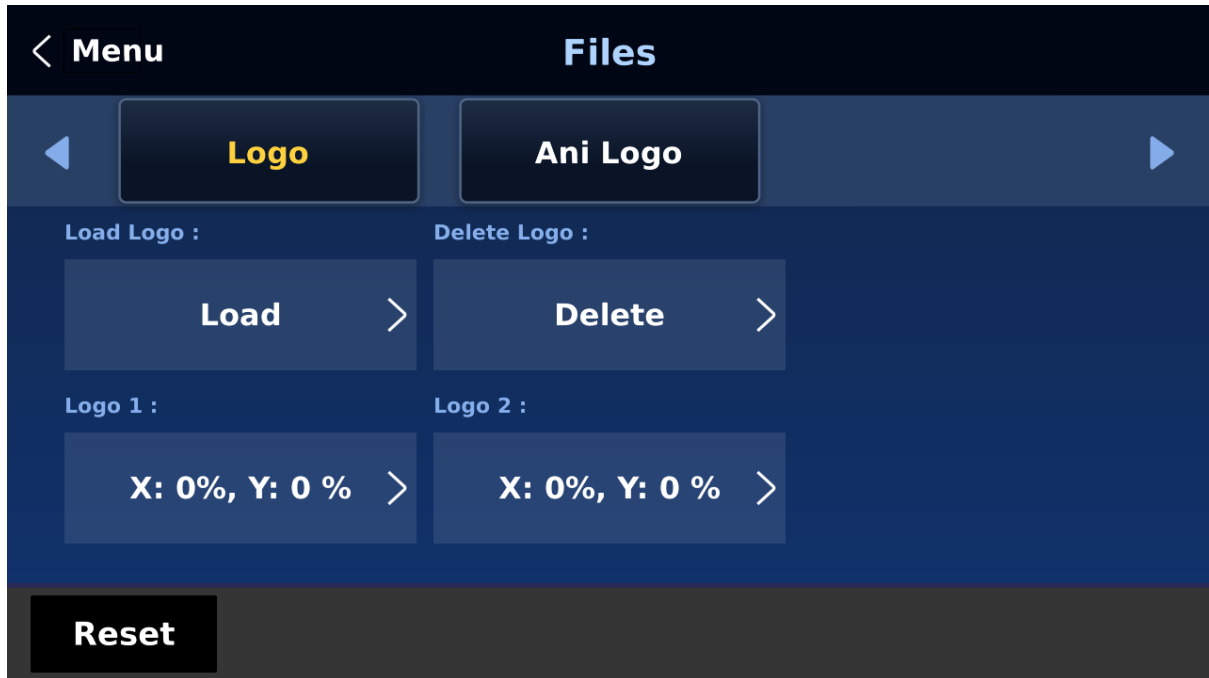

2. Tap Load Logo.



On the page shown above, you should find a thumbnail view of three logos. Use the right/left arrow buttons at the bottom of the page to browse all other logos which are shown in numerical order. Blank thumbnails are unused memory slots.

To load a still logo, simply select a logo buffer first then browse to a still logo number and lastly select **'Load'**. The selected still logo should be loaded into the selected buffer.

To adjust the logo position, simply change the **X** and **Y** values of the respective logo buffer which can be found at the bottom of the **Logo** menu.

Selecting **"Clear Logo"** clears the logo buffer. Selection of **"Delete Logo"** removes the logo from the selected memory slot.

### **Importing Still Logo from the PC**

The Switcher Image Import/Export software (**SwitcherImageImEx\_vx.x.x.msi**) allows the user to import still logos from the PC to a designated memory slot of the switcher. **The software installation package can be downloaded from the product page.**

**Note: A standard still logo is basically a still picture with an aspect ratio limited to 480x1080.**

See [Chapter 4](#) for installation instructions and network configuration.

#### **How to use**

1. Open the Switcher Image Import/Export Program and make sure the **Connect Status** shows **"Connected"** (shows **Not Connected** if disconnected).

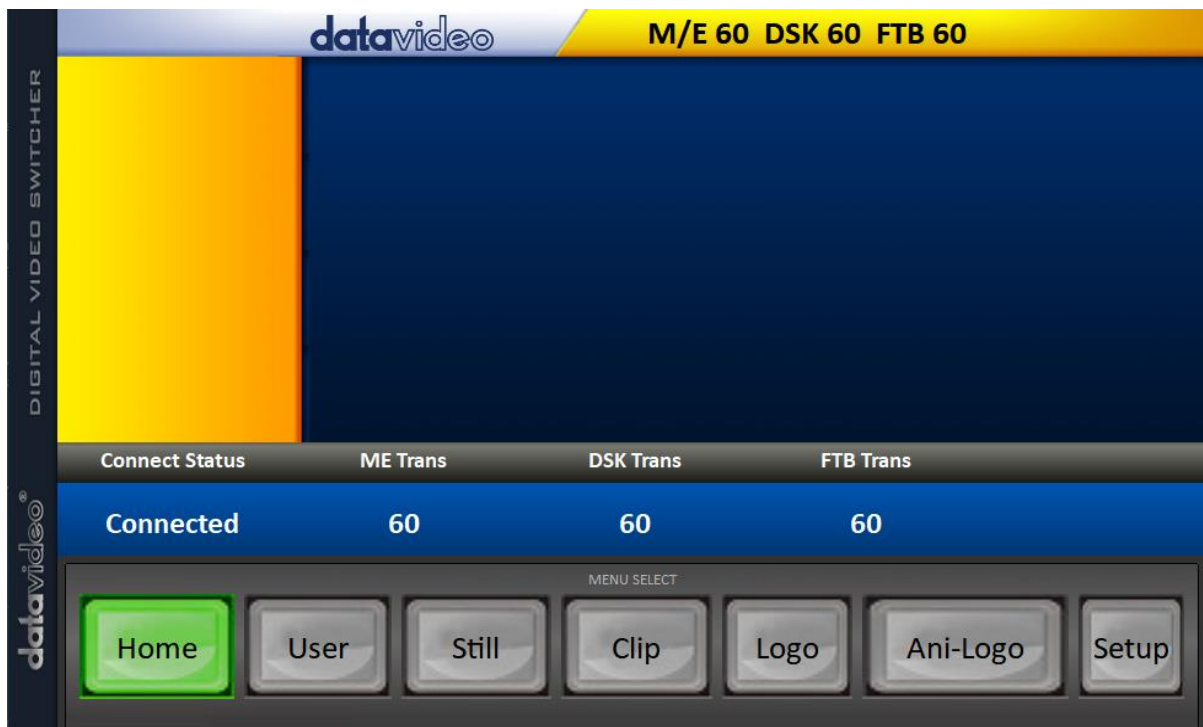



2. Clicking the **Logo** button to view logo thumbnails and import logos from your PC to the switcher.



3. Click “**Logo**” number then enter a memory slot number. Click “**Import Logo**” to open the file browser window and browse to the file that you would like to import.
4. Select the logo file that you would like to import. **Note that the aspect ratio is limited to 480x1080.**
5. Check on the program’s Logo page to make sure that the logo has been imported successfully.





6. After successfully importing the logo into the switcher, you will then be able to start loading the new logo to the buffer. To enable the logo on Preview and Program Out, press the respective Logo buttons.

## 6.5 Enabling Logo Animation

The SE-4000's logo animation function places an animated logo layer on your video. Each animated logo consists of a series of 120 sequential files in bmp, jpg, png or pic format. Every image file is limited to an aspect ratio of 480x270.

In this section, we will show you how to import animated logo to the switcher, load animated logo on the switcher as well as enabling the loaded animated logo on Preview and Program Out.

**Note: The SE-4000 has enough storage space for up to 250 uncompressed animated logo.**

### *Loading an existing Ani-Logo from Memory*

The SE-4000 allows the user to load ani logo from the machine's memory to the logo buffer (Logo 1 or 2), then press either Logo 1 or Logo 2 button to enable the loaded ani logo on both the Preview and Program Out. Follow the steps outlined below to load the desired ani logo from memory.

1. Open the ani logo sub menu in the Files menu.

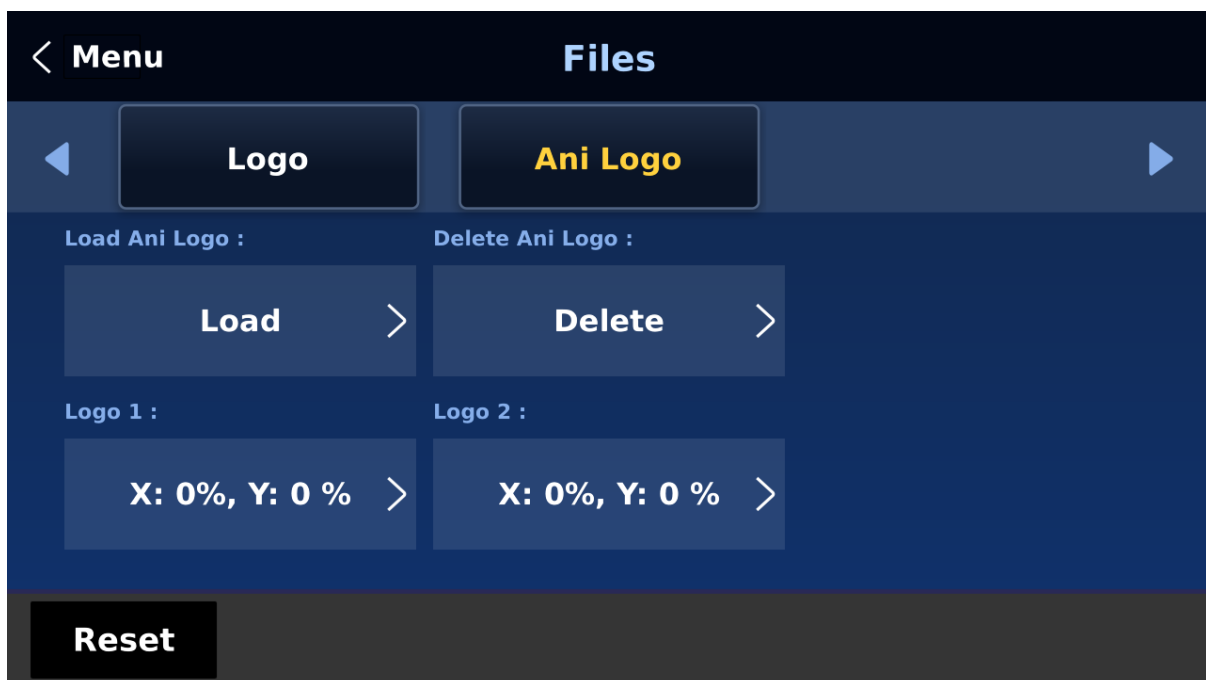

## 2. Tap Load Ani Logo.



On the page shown above, you should find a thumbnail view of three animated logos. Use the right/left arrow buttons at the bottom of the page to browse all other animated logos which are shown in numerical order. Blank thumbnails are unused memory slots.

To load an animated logo, simply select a logo buffer first then browse to an ani logo number and lastly select '**Load**'. The selected animated logo will be loaded into the selected buffer.

To adjust the animated logo position, simply change the **X** and **Y** values of the respective logo buffer which can be found at the bottom of the **Ani Logo** menu.

Selecting "**Clear Logo**" clears the logo buffer. Selection of "**Delete Logo**" removes the animated logo from the selected memory slot.

### ***Importing Animated Logo from the PC***

The Switcher Image Import/Export software (**SwitcherImageImEx\_vx.x.x.msi**) allows the user to import animated logos from the PC to a designated memory slot of the switcher. **The software installation package can be downloaded from the product page.**

**Note: Each animated logo consists of a series of 120 sequential files in bmp, jpg, png or pic format. Every image file is limited to an aspect ratio of 480x270.**

See [Chapter 4](#) for installation instructions and network configuration.

### ***How to use***

1. Open the Switcher Image Import/Export Program and make sure the **Connect Status** shows "**Connected**" (shows **Not Connected** if disconnected).

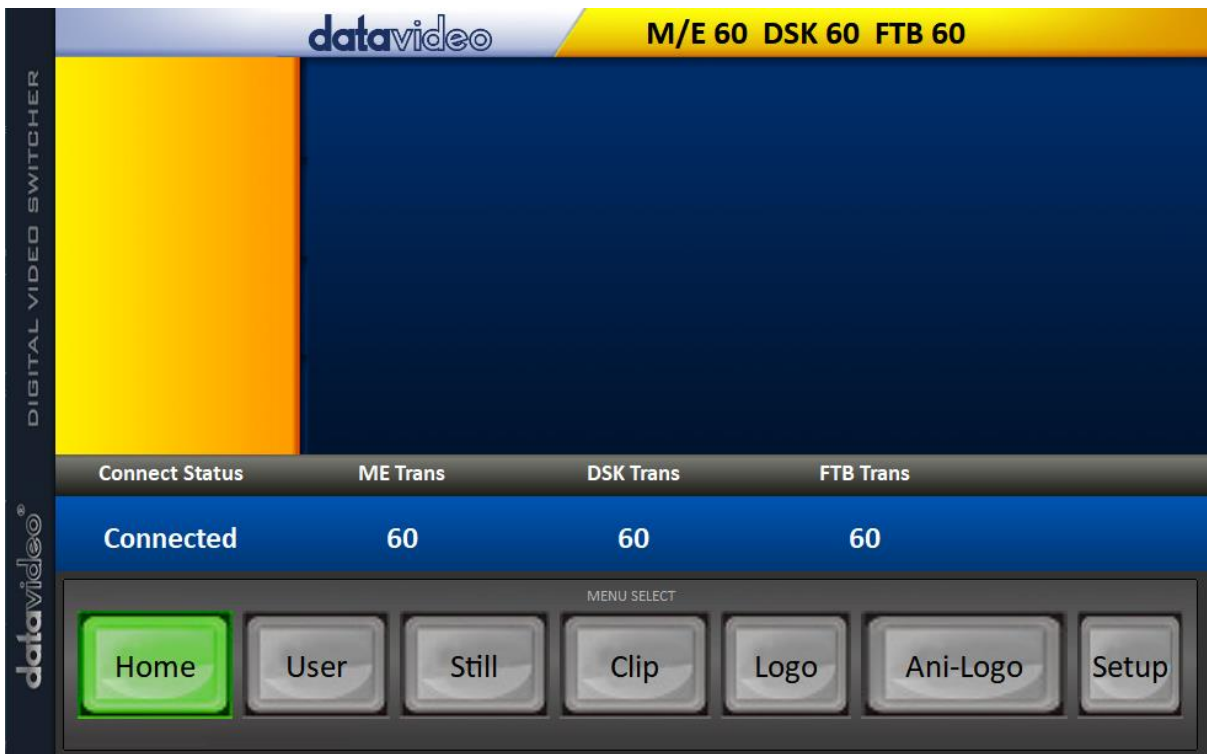

2. Clicking the **Ani-Logo** button to view animated logo thumbnails and import animated logos from your PC to the switcher.



3. Click "**Ani Logo**" number then enter a memory slot number. Click "**Import Ani-Logo**" to open the file browser window and browse to the file that you would like to import.
4. Select the animated logo file at the zeroth location so upon file import, the program will then link all images up into a sequential animation file. If your files are not the .pic format, they will be automatically converted to .pic format by the program first.

5. Check on the program's Ani Logo page to make sure that the animated logo has been imported successfully.

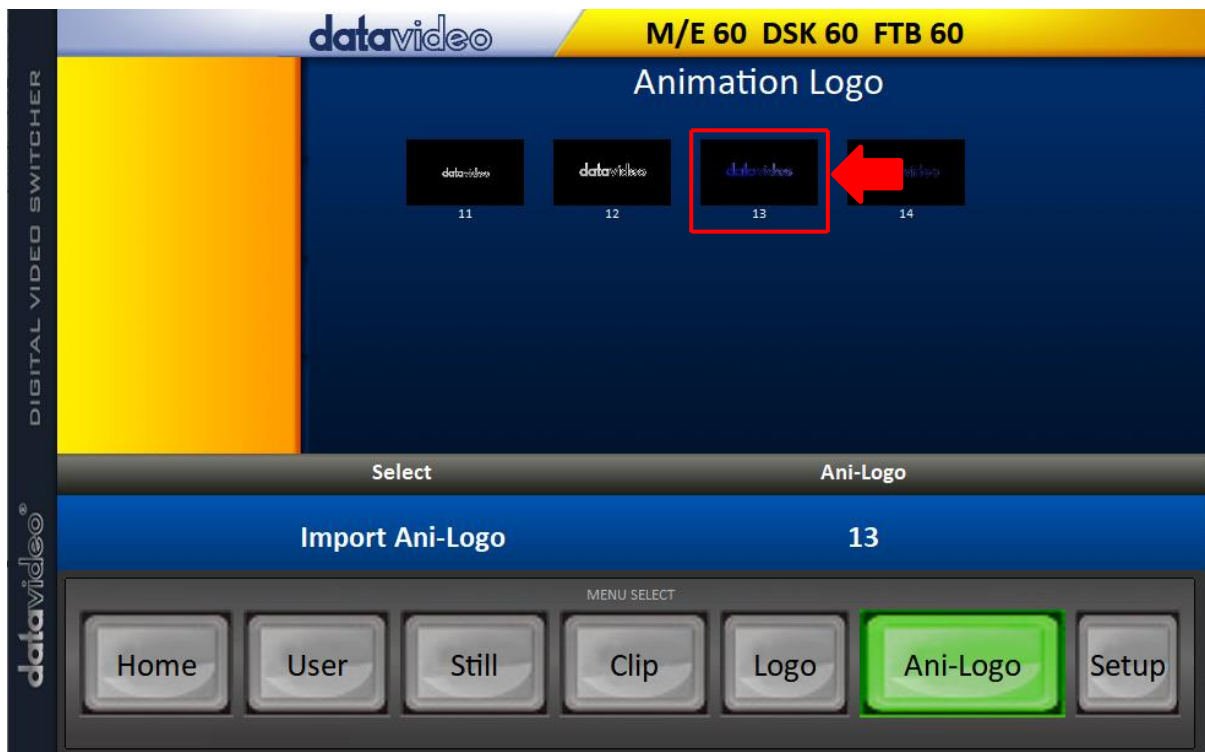

6. After successfully importing the animated logo into the switcher, you will then be able to start loading the new animated logo to the buffer. To enable the animated logo on Preview and Program Out, press the Logo button.

## Chapter 7 Advanced Operation

The SE-4000 is a High Definition Digital Video Switcher. As well as mixing video and audio sources, it has additional functions such as Picture In Picture (PIP), DSK, LUMA KEY, Chroma Key and Logos.

Before attempting to use the SE-4000's PIP, DSK LUMA KEY and LOGO functions it may help to first understand the order of the video layers at the SE-4000 Program (PGM) outputs.

### PROGRAM or PREVIEW Layers

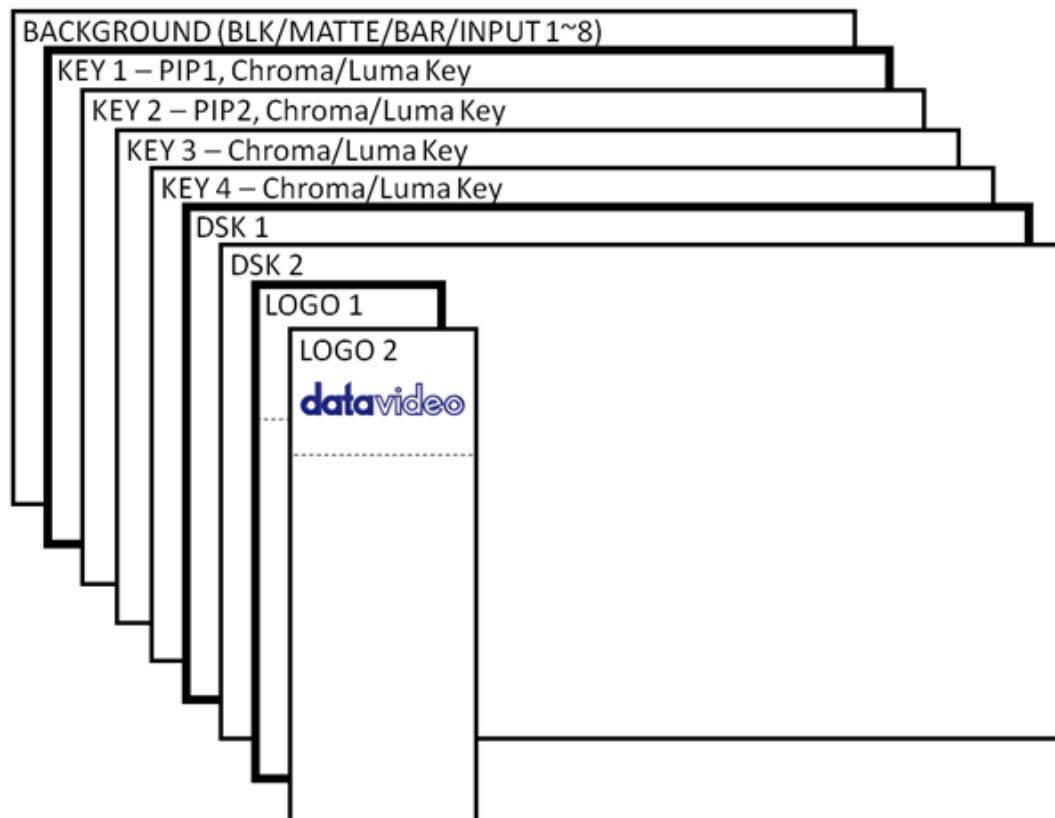

When logos 1 and 2 are enabled on PROGRAM and PREVIEW windows at the same time, you will be allowed to select two types of logos.

- Standard logo: max size of 480 x 1080 (1 still frame)
- Animated logo: max size of 480 x 270 (dynamic made up of 120 frames)

The **Background video layer** is the normal video layer (**black screen, color matte, color bars, inputs 1-8**) when mixing and switching with the SE-4000. It occupies the whole screen area of the Program output. This layer can be hidden or partly hidden by the PIP, DSK and LOGO layers in front of it.

The **Key 1 layer (PIP1, chroma key or luma key)** does not occupy the whole screen and is shown in front of the Background video layer when enabled.

The **Key 2 layer (PIP2, chroma key or luma key)** does not occupy the whole screen and is shown in front of the Background video and Key 1 layers when enabled.

The **Key 3 layer (chroma key or luma key)** does not occupy the whole screen and is shown in front of the Background video, Key 1 and Key 2 layers when enabled.

The **Key 4 layer (chroma key or luma key)** does not occupy the whole screen and is shown in front of the Background video, Key 1, Key 2 and Key 3 layers when enabled.

In some setups the Key image can be hidden behind other key images. This is not a fault. Change the position or size of the Key image if required.

The **DSK 1 layer** can occupy the whole screen. If set up incorrectly this layer can stop the video layers behind it from being seen properly. Re-adjust your DSK 1 settings or switch off the DSK1 function on the SE-4000 to restore the video behind it.

The **DSK 2 layer** can occupy the whole screen. If set up incorrectly this layer can stop the video layers behind it from being seen properly. Re-adjust your DSK 2 settings or switch off the DSK2 function on the SE-4000 to restore the video behind it.

The logo layer is the uppermost layer. If the standard logo (still) is chosen, the maximum logo size will be restricted to 480x1080. If the animated logo (dynamic) is chosen, the logo will be confined within 480x270.

**Note:** Where possible prepare and position the upper video layer elements in advance of the live production starting to avoid them appearing on the program output incorrectly.

Most broadcast networks have guidelines and advice on the use of video, images, music, logos and on screen text so it is best to check beforehand when planning a production. Do not use copyright protected content until you have the relevant permissions. Information on royalty free video, images and music is widely available, speak to your local dealer or search for advice on the internet.

## **7.1 Picture-in-Picture and Downstream Key**

The **Picture in Picture (PIP)** feature of the **Key 1, Key 2, Key 3 and Key 4** layers can be used for displaying a smaller secondary image in front of the background video layer. This smaller PIP image can be resized, cropped, repositioned and even keyed by the user to avoid an important part of the background video layer being covered by it.

The **Down Stream Key layers (DSK 1 & DSK 2)** are placed on top of all the previous layers. These layers are typically used with Character Generator inputs for displaying titles, graphics, lower thirds, clocks and logos. Datavideo offer several Character Generator products (additional purchase) such as CG-250, CG-10 and CG-500. If set up incorrectly these DSK layers can also stop the video layers behind them from being displayed properly.

The SE-4000 has six dedicated keyers, **Key1, Key2, Key3, Key4, DSK 1 and DSK 2**. All six keyers can be active simultaneously. In the following sub-sections, we will provide you with descriptions of different keyer settings and ways to access them.

## Picture-In-Picture

In this example, we are supplying the SE-4000 with an HD-SDI live video signal to input 2; this is selected on the Program row. We have also assigned a STILL image to input 6. This still image, selected on the [Keyer](#) sub menu, will be displayed in the PIP window.

**Note:** See [Still](#) of [Section 5.8](#) for assigning a STILL image to input 6.



On the SE-4000 Control Panel / Keyboard there are eight **KEYER** keys. These are labelled Program and Preview. The upper **KEYER** keys relate to activating Picture-In-Picture images on the Program outputs. The lower **KEYER** keys relate to activating Picture-In-Picture images on the Multi-view or Preview outputs. Before activating

Picture-In-Picture images on the output image, you should first set these **KEYER** keys to PIP mode.

### Assigning a video source to a PIP window

On the **Keyer** menu you can assign a selected input to the chosen PIP video layer.

1. Open the **Keyer** menu to select **Keyer 1** and in the **Keyer Ctrl** sub menu, set **Key 1** to the desired key mode (**Luma**, **Chroma** and **Linear**) and PIP mode as shown below.



2. In the **Key Source** sub menu, assign an input source, in this example, it's Input 6.

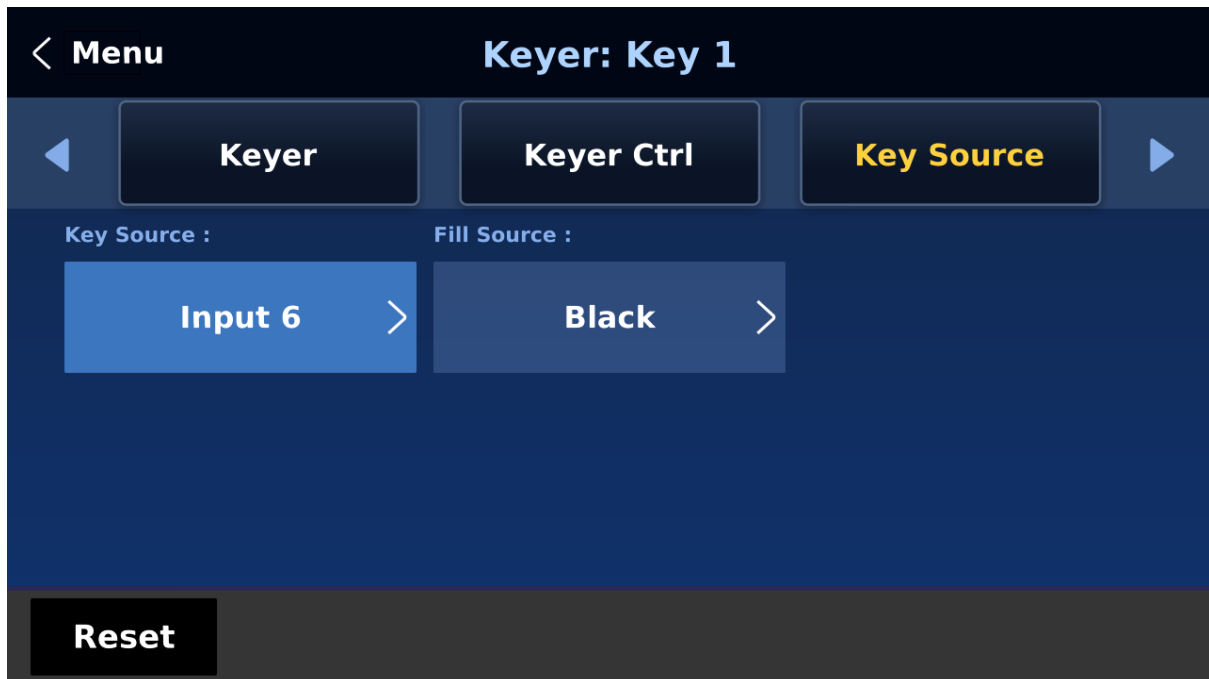

3. Activate the PIP window on the Preview or Program output by pressing **Key 1 PVW** or **Key 1 PGM** button so that you can adjust the PIP window while viewing the changes made.
4. Open the **P-in-P** menu and adjust the PIP window settings (**positions**, **border**, **shade matte** and **crop**). For descriptions of the parameters, refer to the section on [P-In-P](#) for more details.

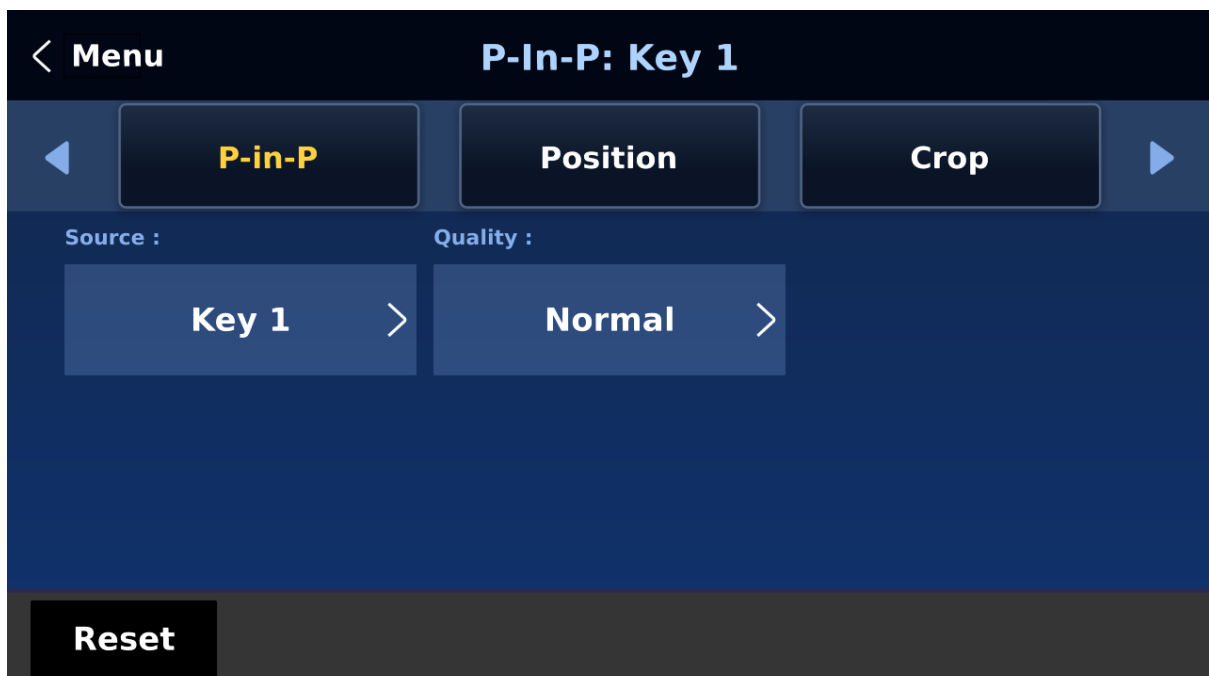

#### ***Assigning a video source to a PIP window using shortcut keys***

In addition to assigning a video source to a PIP window on the **GUI MENU**, the user can also use shortcut keys to easily switch between different PIP image sources. Press and hold **KEY 1-**



**4 PGM** buttons, and the program and preview rows should start blinking. Press the program row buttons to select the PIP image source.

### ***Character Generator***

The CG mode allows you to linear key the CG text or graphics over the live video. Simply connect the laptop, with CG-500 software installed, to one of the HDMI inputs (input ports 9 to 12 or input channels 3, 4, 7 and 8) of the switcher. Ensure that your input image or video resolution matches the switcher’s resolution set in [GUI](#) → [Setup](#) → [Standard](#).

#### **Then follow the steps below to set up the CG input**

1. Connect the laptop with CG-500 software installed to one of the HDMI ports of the SE-4000 switcher using an HDMI cable. In this example, we will be using HDMI port 9 for illustration purpose.
2. Open CG-500 on the laptop and create a CG image.
3. Switch ON the SE-4000’s power button and after the boot up is complete, the Multiview should be displayed on the connected monitor.
4. On the Multiview, Input 3 window should display the CG image.
5. On GUI, tap **Inputs**.
6. Select **Input 3** from **Source** and enable CG mode by turning on CG Md in second mode of operation.
7. Open the “**Keyer**” sub menu.
8. Select “**DSK 1 or 2**” from the **Keyer** option and set Key and Fill Sources to Input 3.
9. Locate DSK buttons on the switcher’s control panel then depending on the DSK keyer selected at Step 8, press DSK 1 or 2 button to open your CG graphics on either of the preview and program windows or both.

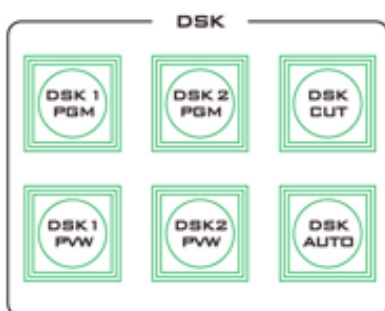

#### ***DSK Preview and DSK Program***

On the SE-4000 Control Panel / Keyboard there are four DSK keys. These are labelled Program and Preview. The upper DSK1 and DSK2 keys relate to activating Down Stream Keying on the Program outputs. The lower DSK1 and DSK2 keys relate to activating Down Stream Keying on the Multi-view or Preview outputs.

To display the CG subtitle configured previously, simply press the DSK 1/2 PGM or DSK 1/2 PVW button to enable the downstream key on the PGM or PVW screen.

## 7.2 Placing text on the video using luma key



The SE-4000 allows the user to place a logo or text image (ideally black and white) on the video using the luma key function. First of all, create a 1920x1080 (16:9) text image against a black or white background on a laptop. Once the text image is created, please follow the steps outlined as follows to insert the text image.

**Note: If the text image is dark, choose a white background; if the text image consists primarily of bright colors, choose a black background.**

1. Connect the laptop to the switcher's **HDMI Input Port 9 (Input Channel 3)**.
2. On the SE-4000 control panel, press the **Keyer** button to open the Keyer menu on the 5 inch touch screen.
3. Select Key 1.

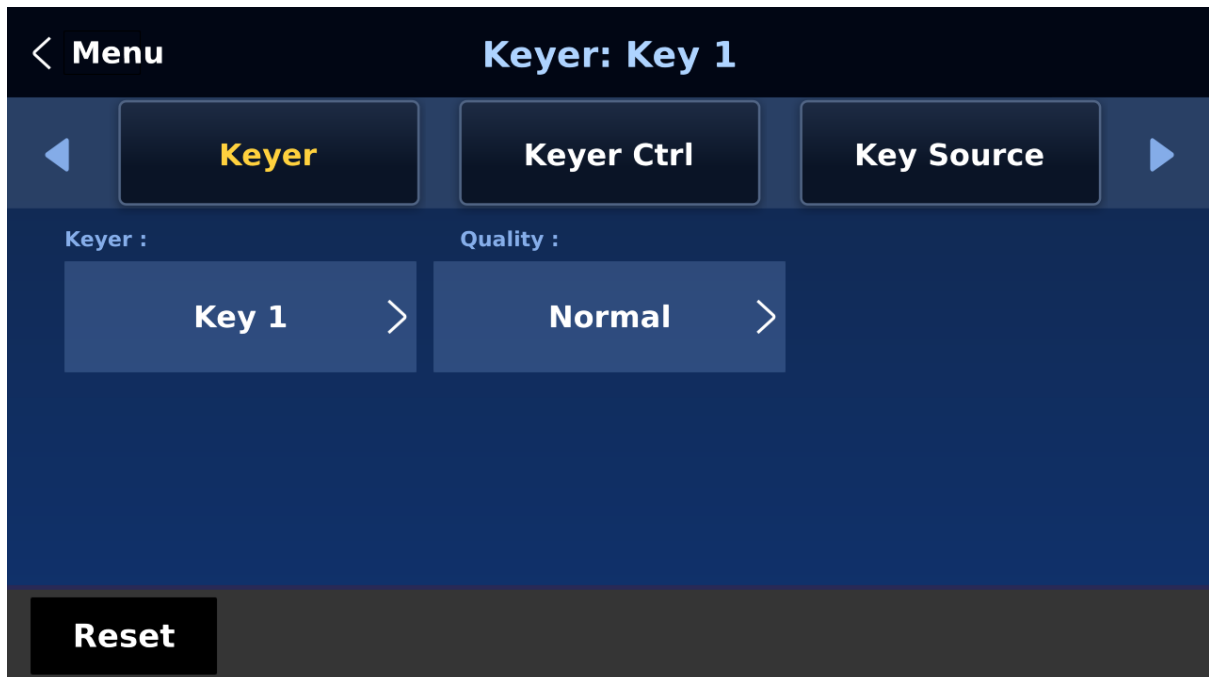

4. In the **Keyer Ctrl** sub menu, select **"Luma"** and **"Self"** to apply luma keying effect to the connected input. The luma key removes the background, in this case, the black component of the image.



5. In this example, the text image is against a black background so **reduce the Lift value to remove the black background**. Descriptions of the corresponding parameters are described below:
  - **Lift** (0 – 100%) adjusts the dark/black areas of the key image. **Reducing the value of Lift** will make dark areas of the key image more transparent. The background image will be showing only through the transparent areas.
  - **Gain** (0.0 – 16.0) adjusts the light/white areas of the key image. **Increasing the value of Gain** will make light areas of the key image more solid. The background image will be showing only through the transparent areas.
  - **Opac** (0 – 100%) adjusts the transparency of the overall foreground image, which is the text in this example. **Increasing the value of Opacity** will make the overall key image less transparent.
  - **Invert** (On/Off) sets the luma key color; luma key color is **white** if turned ON and **black** if turned OFF.
6. Set the “**Lift**” to 100% if the background is in total black.
7. **Opaque** logo can be created by setting the “**Opac**” parameter to 100%. Set “**Opac**” to 100% if an opaque logo is desired. **Semi-transparency** effect can be generated by setting the “**Opac**” parameter to a value between 0 and 100%.
8. In the **Key Source** sub menu, select an input source to which the luma key settings will be applied. In this example, select “**Input 3**” since this is the corresponding input channel of HDMI input port 9 to which the laptop is connected.  
**Note: Since “Self” is chosen, Fill Source can be ignored.**



9. After the luma key settings are properly configured, press the **Key 1 PGM** or **Key 1 PVW** button to place the text image on the Program screen or the Preview screen respectively.

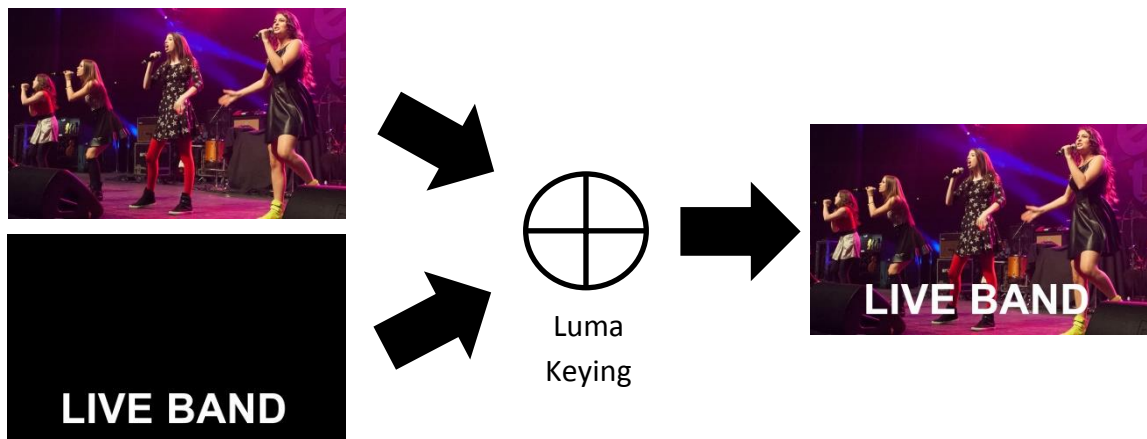

### 7.3 Insertion of People onto Backgrounds (Chroma Key)

The Chroma Key feature of the SE-4000 is easy to use. Typical Blue and Green screen studios can be quickly incorporated into an SE-4000 production.

The following is a quick overview of Chroma Key basics.

The **camera**, **backdrop** and **lighting** all play an important role in producing the optimal Chroma Key result. Although the SE-4000 is equipped with excellent keying controls, it is best to start with a good keyable image.



**A good foreground image helps produce a good key**

### Three chip/Three sensor camera

We strongly recommend the use of a three chip or three sensor camera for Chroma Key shooting. If the camera has three chips or sensors then this usually means good colour separation within the camera. The optics on these cameras are usually better too. The extra image clarity and the good colour separation help improve the quality of the subsequent keying with the camera's output.

### White Balance the Camera

White Balance is extremely important after setting up a chroma key studio. The camera must be correctly white balanced to minimize the subject picking up any colour cast (green or blue) from the background. Of course the white balance settings will vary according to the type of lighting you are using, but neutral whites and good skin tone colour are the all-important targets.

To set the white balance you will need a white reference card (or a sheet of white paper). Focus the camera on the reference card and light it evenly using the main light. Set the camera's iris / aperture so that the card is correctly exposed. Use the Auto White Balance (AWB) function, or set the white balance manually so that the card appears white. If you are in any doubt about how to white balance your camera, **please refer to your Camera's instruction manual for more details.**

### Lighting

Lighting of your chosen green or blue backdrop is extremely important; the more even the lighting on the backdrop the better the finished result. Lighting setups for the foreground subject will vary according to the effect that you want. For chroma keying backdrops, balanced even lighting with no hotspots or shadow areas is the aim. The easiest way to achieve balanced Chroma key lighting is with a lighting setup that looks similar to this:

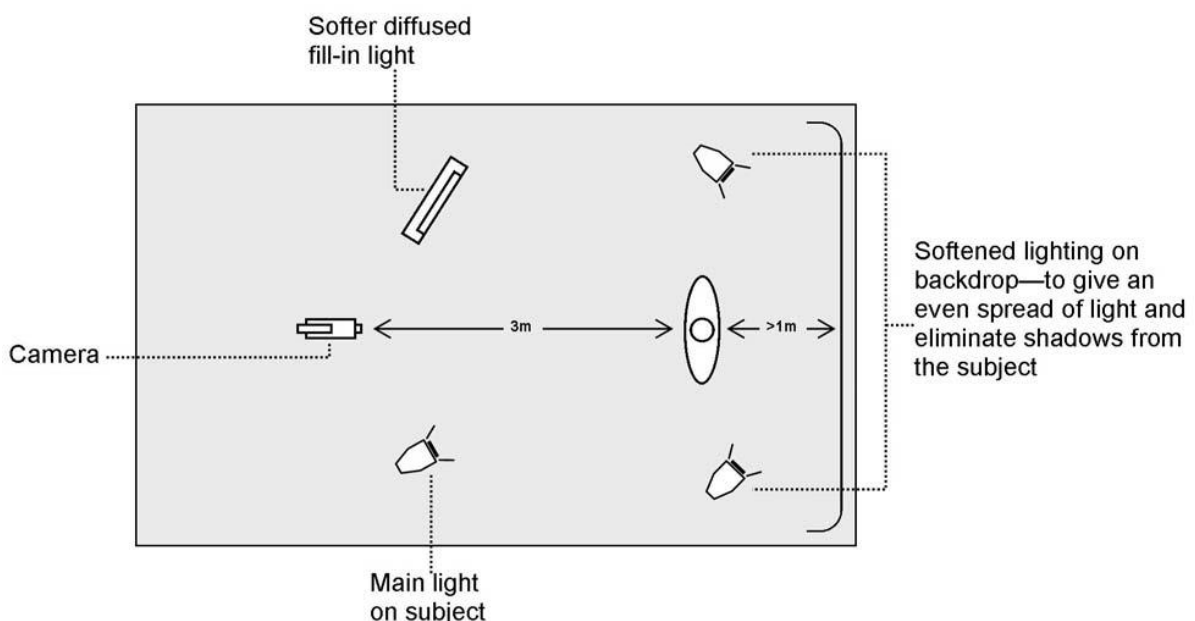

In the diagram, you will see that we recommend a **minimum** of four lights and we keep the subject **more than** 1m away from the backdrop. It is always easier to get more even lighting

if the subject is farther away from the backdrop (no shadows). The foreground lighting on the subject will also vary according to the effect that you are looking for.

After the studio set up is complete, connect the camera shooting the speaker on a green backdrop to the SDI Input 1 at the rear of the switcher. To configure the settings that will be used for chroma keying, press the **MENU** button on your SE-4000 control panel to open the GUI menu on the monitor. Follow the steps below to configure the chroma key settings.

1. Open the Keyer menu and select Key 1.

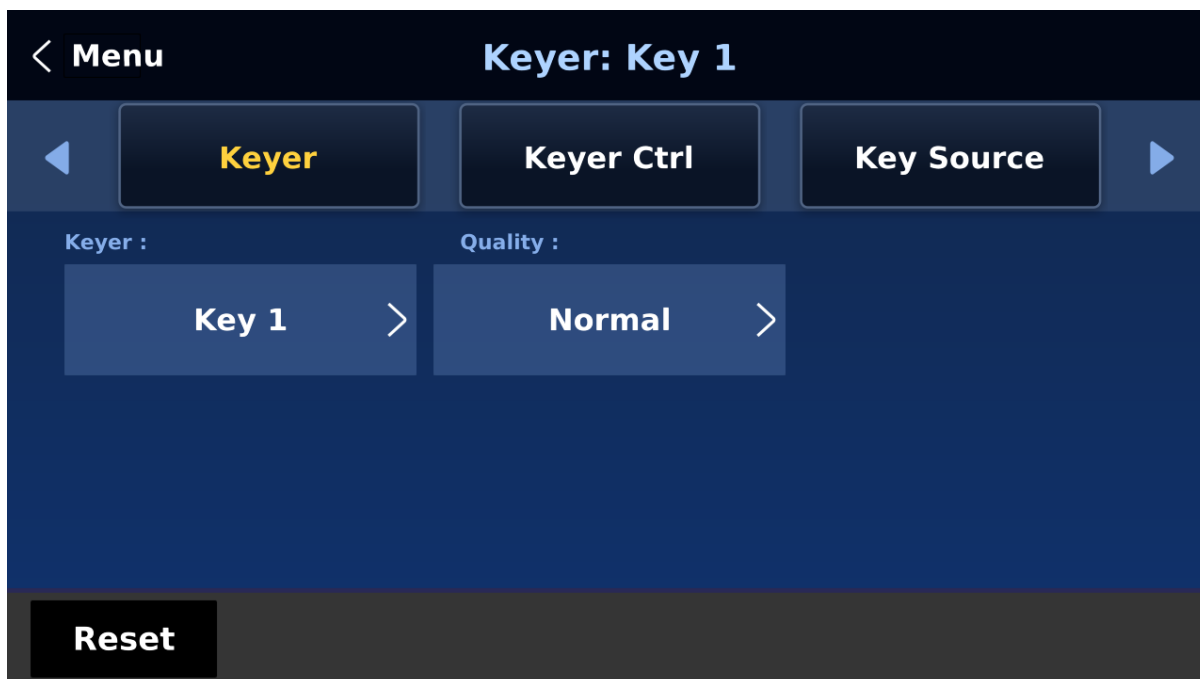

2. Select "Chroma" and "Self" in "Keyer Ctrl"



3. Select the camera source in “**Key Source.**” In this example, we have selected Input 1, which corresponds to the SDI Input 1 at the rear of the switcher and therefore the port to which the camera is connected.

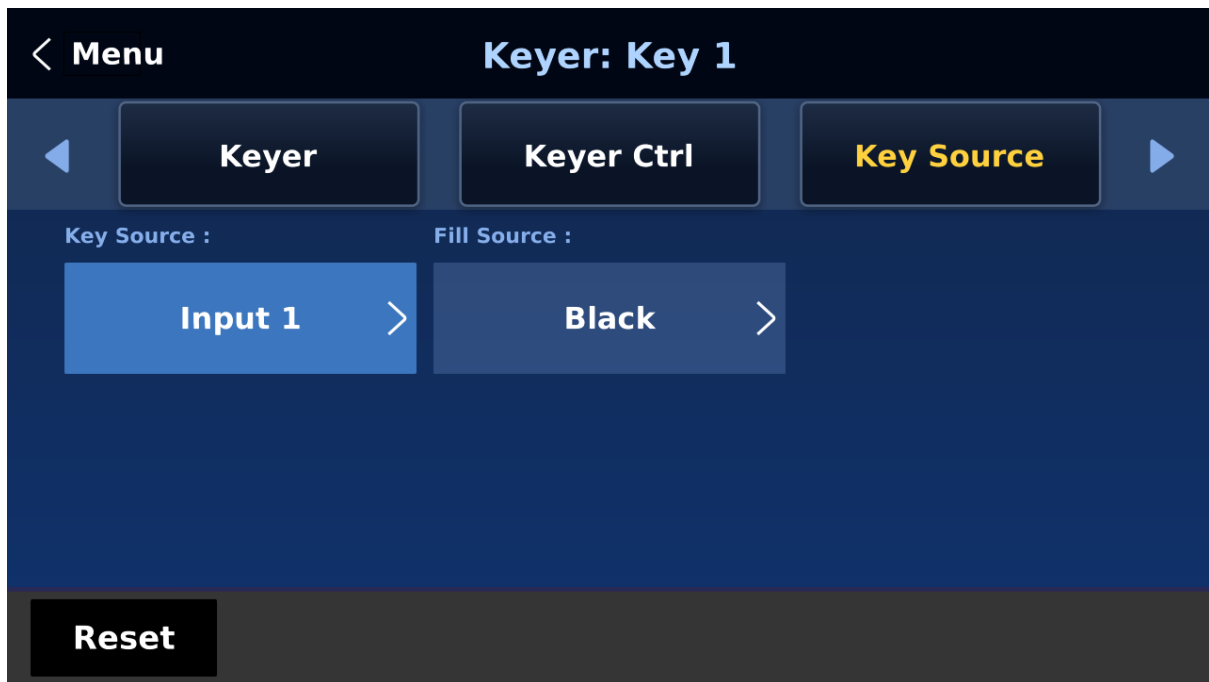

4. Adjust the left, right, top and bottom values of “**Mask**” to set the chroma key range according to the green or blue backdrop size.



5. Open the Chroma menu to adjust the corresponding chroma keyer parameters. Again in this example, we have selected Input 1, which corresponds to the SDI Input 1 at the rear of the switcher.



**Note:** Select **CK Auto** to automatically calculate the best Hue & Luma values for the current Keyer source.

The chroma keyer parameters are described below:



- **Hue:** This parameter adjusts the color of the chroma key. A typical green screen value will be around 120. Blue screen value will be around 240.
- **Luma:** The **Luma** value relates to how bright or dark the selected key colour or hue is.
- **K Range (Key Range):** **Key Range** sets the range of hues or colors (0 – 360 degrees) that closely match the background color to be keyed. The user can start with a value of 120 degrees and this value can be fine-tuned up or down depending on the setup of the green or blue screen studio.



- **K Fgnd** (Key Foreground): **Key Foreground** adjusts the performance of the chroma key in light or white areas. Apply more **Key Foreground** if the light areas are becoming too transparent.
  - **K Bgnd** (Key Background): **Key Background** adjusts the performance of the chroma key in dark or black areas. Apply more **Key Background** if the dark areas are becoming too transparent.
  - **Hi-Light**: Hi-light boosts the foreground key in high luminance area.
  - **Lo-Light**: Lo-light boosts the foreground key in low luminance area.
  - **Bg-Supp**: Turn ON **Background Suppress** removes the Luma (Brightness) of the background from the final image. If the Chroma Key Output is showing Light Edges, then the **Bgnd suppress** can be used to suppress any background Luma that is showing through on these edges.
6. After configuring the chroma keyer, exit the menus and simply press **KEY 1 PGM** or **KEY 1 PVW** button on the switcher's control panel to place the speaker on **PGM** or **PVW** Screen as shown in the diagram below.

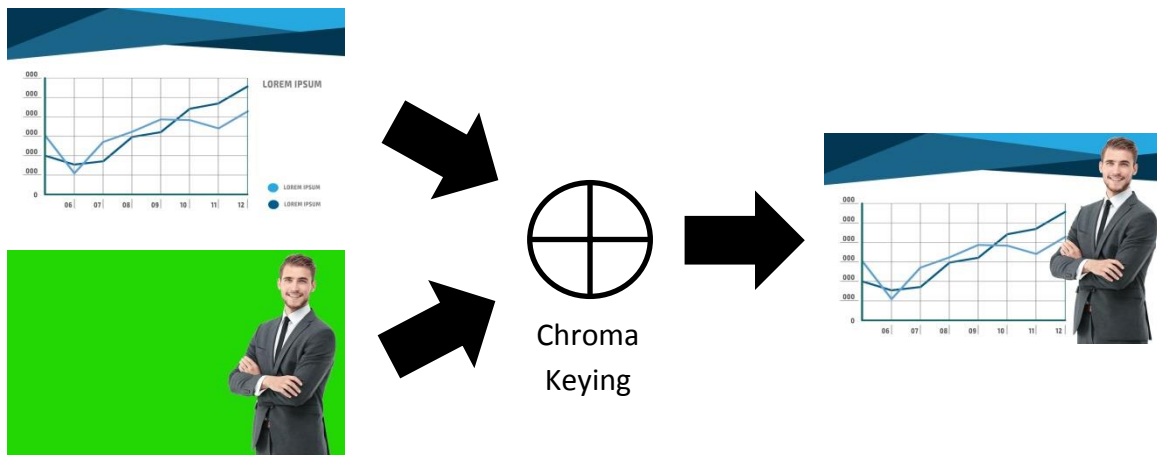

## Chapter 8 Appendices

### Appendix 1 Tally Outputs

The SE-4000 has a D-sub 25 pin female tally output port. These connections provide bi-colour tally information to a number of other Datavideo products, such as the ITC-100 eight channel talkback system and the TLM range of LCD Monitors.

These ports are open collector ports and as such do not provide power to tally light circuits.

Dielectric strength: Max. DC 24V

Current: Max. 50mA

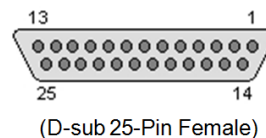

The pin outputs are defined as follows:

Pin No.	Signal name	Input/Output	Signal Description
1	Program 1	Open collector output	Tally output of input video Program 1
2	Program 2	Open collector output	Tally output of input video Program 2
3	Program 3	Open collector output	Tally output of input video Program 3
4	Program 4	Open collector output	Tally output of input video Program 4
5	Program 5	Open collector output	Tally output of input video Program 5
6	Program 6	Open collector output	Tally output of input video Program 6
7	Program 7	Open collector output	Tally output of input video Program 7
8	Program 8	Open collector output	Tally output of input video Program 8
9	Program 9	Open collector output	Tally output of input video Program 9
10	Program 10	Open collector output	Tally output of input video Program 10
11	Program 11	Open collector output	Tally output of input video Program 11
12	Program 12	Open collector output	Tally output of input video Program 12
13	GND	Ground	Ground
14	Preview 1	Open collector output	Tally output of input video Preview 1
15	Preview 2	Open collector output	Tally output of input video Preview 2
16	Preview 3	Open collector output	Tally output of input video Preview 3
17	Preview 4	Open collector output	Tally output of input video Preview 4
18	Preview 5	Open collector output	Tally output of input video Preview 5
19	Preview 6	Open collector output	Tally output of input video Preview 6
20	Preview 7	Open collector output	Tally output of input video Preview 7
21	Preview 8	Open collector output	Tally output of input video Preview 8
22	Preview 9	Open collector output	Tally output of input video Preview 9
23	Preview 10	Open collector output	Tally output of input video Preview 10
24	Preview 11	Open collector output	Tally output of input video Preview 11
25	Preview 12	Open collector output	Tally output of input video Preview 12

### Example of tally connections

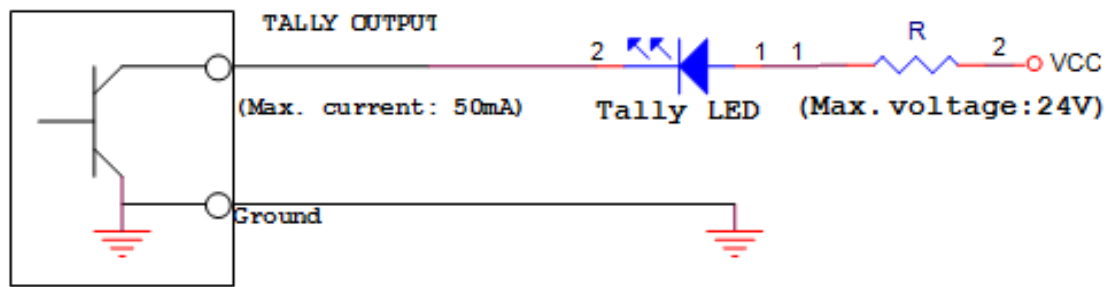

## Appendix 2      GPI / GPO Connections

The SE-4000 can control external recorder/playback devices like the HDR-80 and HDR-90 via a simple contact closure GPI / GPO switch.

The GPI interface is a 3.5mm Jack Socket which is situated on the rear panel of the SE-4000. Contact closure between the Outer and Inner contacts on the jack plug will trigger a user selected event. Power is supplied by the SE-4000 and is less than 5V DC.

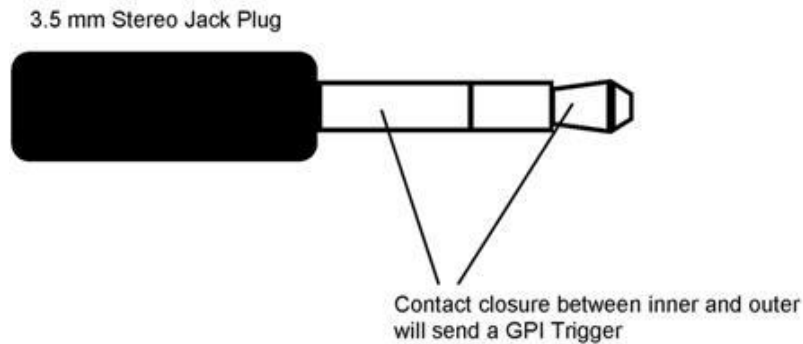

This GPI socket can also be used as a GPO socket to trigger record or playback events with other equipment such as the Datavideo HDR-80 or HDR-90 recorder.

**SAFETY FIRST** The cabling required needs to be designed specifically to connect the SE-4000 to the chosen record or playback device as they are not all the same. The cabling required can be made by yourself or a competent technician. Please speak with your Dealer or local Datavideo office to get further help and advice.

### Appendix 3 RS-232 Serial Port Pinout

The user is allowed to connect a custom keyboard controller to the SE-4000 via RS-232 interface (the user may also enable RS-422 if necessary). The table below provides the RS-232 serial port pinout on the device end (SE-4000). Note that the RS-232 port is a 9 pin D-sub female connector.

Pin No.	Signal
Pin 1	GND
Pin 2	TXD (RS-232)
Pin 3	RXD (RS-232)
Pin 4	GND
Pin 5	GND
Pin 6	GND
Pin 7	TXD (RS-422)
Pin 8	RXD (RS-422)
Pin 9	GND

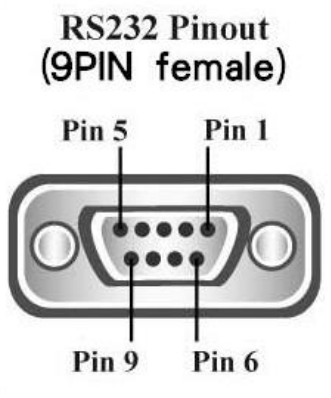

The diagram shows a 9-pin D-sub female connector. The pins are arranged in a 3x3 grid. The top row contains Pin 5 (left) and Pin 1 (right). The middle row contains Pin 9 (left) and Pin 6 (right). The bottom row contains two unlabeled pins. The connector is labeled "RS232 Pinout (9PIN female)".

You may download the RS-232 control protocol from the product page.

## Appendix 4      Firmware Update

Datavideo usually releases new firmware containing new features or reported bug fixes from time to time. Customers can either download the SE-4000 firmware as they wish or contact their local dealer or reseller for assistance.

**The existing SE-4000 settings should persist through the *firmware upgrade process, which should not be interrupted once started* as this could result in a non-responsive unit.**

**Successful firmware upgrade on SE-4000 requires:**

- PC or laptop
- USB drive
- Access to the Internet for software download

### ***Firmware Upgrade Procedures***

**The main unit and the control panel are upgraded independently. See the sections below for respective firmware upgrade procedures.**

#### ***Main Unit***

1. Download the latest firmware and the update tool from the path below.  
[www.datavideo.com](http://www.datavideo.com) → products → Switchers → SE-4000 → Downloads → Latest Firmware
2. Extract the contents of the compressed file to the Desktop.
3. Insert a USB thumb drive into the PC or laptop and format the drive to FAT or FAT32 system. Save the latest firmware files on the drive.
4. Remove the USB drive from the PC or laptop.
5. Insert the USB drive into the **F/W Upgrade** port at the rear of the main unit.
6. Power ON the main unit and if you see an image showing on the output screen after about 40 seconds, then the main unit has been successfully upgraded so remove the USB drive from the **F/W Upgrade** port.

#### ***Control Panel***

You can upgrade the control panel either via the **USB Service Port** or **Ethernet Port**.

#### **Service Port**

Follow the steps outlined below to upgrade via the USB Service Port.

1. Download the latest firmware and the update tool from the path below.  
[www.datavideo.com](http://www.datavideo.com) → products → Switchers → SE-4000 → Downloads → Latest Firmware
2. Extract the contents of the compressed file to the Desktop.
3. Insert a USB thumb drive into the PC or laptop and format the drive to FAT or FAT32 system. Save the latest firmware files on the drive.
4. Remove the USB drive from the PC or laptop.
5. Insert the USB drive into the **Service** port at the rear of the control panel.

6. Power ON the control panel then press the Setup button to open the Setup menu on the built-in 5 inch touch screen. .
7. Tap “Software” → “Upgrade”
8. You will be prompted to confirm the upgrade, tap Yes to proceed.
9. You will see “**Upgrade**” in red while the control panel is being upgraded.
10. When “**Upgrade**” turns green, the control panel has been successfully upgraded.
11. Reboot the control panel to finish the upgrade.
12. To confirm, open the Setup menu and check the software version in **Software**.

### **Ethernet Port**

Follow the steps outlined below to upgrade via the Ethernet Port.

1. Download the CTL Upgrade Tool. Check your laptop’s Windows version before download, make sure the right tool is downloaded for your operating system.
2. Unzip the downloaded file.
3. Open the directory where the CTL Upgrade Tool is unzipped to.
4. Open the CTL Upgrade Tool by double clicking the tool icon.
5. Enter the control panel’s IP address; please note that the default IP address is 192.168.100.102.
6. Click **Source Selection** to browse the hard drive for the latest firmware file (zip).
7. Click **Start** to begin upgrading the control panel’s firmware.
8. When you are prompted “Upgrading Done”, the control panel has been successfully upgraded.
9. Click **CTL Reboot** to reboot the control panel to finish the upgrade.

### ***T-Bar Calibration***

Follow the steps below to calibrate the T-Bar to position it correctly for video transition after the firmware has been updated successfully.

1. Press the SETUP button on the control panel to open the SETUP sub menu on the 5 inch touch screen.
2. At the bottom right of the 5 inch touch screen, tap 7 times until “Force to upgrade” appears at the bottom of the screen.
3. Tap SETUP/Keyboard and you will see two options which are Tbar DOWN Arrow Bound and Tbar Upper Arrow Bound.
4. Push the T-Bar down then tap the Tbar DOWN Arrow Bound value on the 5 inch touch screen.
5. Push the T-Bar up then tap the Tbar Upper Arrow Bound value on the 5 inch touch screen.
6. Reboot the machine then test the calibrated T-Bar.

## Appendix 5      Frequently-Asked Questions

This section describes problems that you may encounter while using the SE-4000. If you have any questions, please refer to related sections and follow all suggested solutions. If problem still exists, please contact your distributor or the service center.

No.	Problems	Solutions
1	<b>Why isn't the logos transitioned?</b>	Logos will not be transitioned as the CUT or AUTO button is pressed, nor will it be transitioned as the T-Bar is pushed.
2	<b>Is there any other way alternative to GUI to reset the main unit's IP address?</b>	Use a needle to push the reset hole next to the DVIP port to restore the default IP address. Push the reset button then hold for about 5 to 10 seconds until the machine reboots itself to restore the IP address to 192.168.100.101.



# Appendix 6      Dimensions & Weight

**Main Unit**

Technical drawings of the Main Unit:

- Top view showing a dense array of connectors and a fan on the right side.
- Front view showing a horizontal slot and a larger rectangular opening.
- Side view showing a depth of 88 mm and a thickness of 5 mm.
- Internal view showing a height of 250.60 mm and a width of 432.40 mm.

**Control Unit**

Technical drawings of the Control Unit:

- Top view showing a keyboard, a small display, and various control buttons.
- Front view showing a height of 77.80 mm and a width of 432.60 mm.
- Side view showing a height of 313.60 mm, a depth of 10.70 mm, and a thickness of 5 mm.

**Weight: 7.1 kg**      **All measurements in millimeters (mm)**

## Appendix 7 Specifications

<b>Model Name</b>	<b>SE-4000</b>
<b>Product Name</b>	<b>4K 8-Channel Digital Video Switcher</b>
<b>Video Standard</b>	4K & HD
<b>Video Format</b>	<p>Input            3840x2160p: 60/59.94/50/30/29.97/25            1080p: 60/59.94/50/30/29.97/25            1080i: 60/59.94/50</p> <p>Output            3840x2160p: 60/59.94/50/30/29.97/25            1080p: 60/59.94/50/30/29.97/25            1080i: 60/59.94/50</p> <p>Latency            50-60 Hz: 1 frame delay (2 frame delay for PIP output)            25-30 Hz: 2 frame delay (3 frame delay for PIP output)</p>
<b>Video Processing</b>	SDI: 4:2:2 HDMI: YUV 4:2:2 10 bit, RGB: 4:4:4 8/10 bit
<b>Input Routable / Crosspoint</b>	Yes
<b>Video Input</b>	Total 8 live inputs (select 8 from 12) 8 x 12G-SDI 4 x HDMI
<b>Computer Graphical Interface</b>	4 via HDMI
<b>Video Output</b>	4 x 12G-SDI / 3 x HDMI assignable: <ul style="list-style-type: none"> <li>• Multiview</li> <li>• Program</li> <li>• Preview</li> <li>• Program + DSK</li> <li>• Clean Program</li> <li>• Clean Preview</li> <li>• Input 1 – 12</li> </ul>
<b>Downconverted Output</b>	The feature will be added via firmware upgrade in the future.
<b>Built-in Multi-View Monitoring Out</b>	HDMI & SDI assignable
<b>Analogue Audio Input</b>	4 x Analogue XLR
<b>Analogue Audio Output</b>	2 x Analogue XLR
<b>Digital Embedded Audio Support</b>	Input: 4 Channels Output: 4 Channels
<b>Audio Delay Calibration</b>	up to 16 Fields or 8 Frames per Channel
<b>A+V Switching</b>	Yes

<b>Chromakey</b>	4
<b>Title Creator</b>	The feature will be added via firmware upgrade in the future.
<b>USK</b>	4 Keyers supporting Chromakey & Linear/ Luma Key
<b>DSK</b>	2 x DSK supporting Lumakey & Linear key (Key / Fill)
<b>Picture in Picture</b>	2
<b>Logo Insertion</b>	2
<b>Still Store</b>	250
<b>Effects</b>	FTB, Cut, 32 Wipe with border
<b>Transition Preview</b>	Full Transitions Preview
<b>Sync / Reference In / Out</b>	N/A
<b>Tally Output</b>	1 x D-sub 25pin, Dual Color
<b>PC Remote Control</b>	DVIP (Ethernet)
<b>Built-in Audio Mixer</b>	Yes
<b>Firmware Update</b>	Ethernet
<b>Special Features</b>	5 inch touchscreen display
<b>Chassis</b>	2 units, 2RU Rack-Mount Mainframe
<b>Dimensions (LxWxH)</b>	433 x 312 x 76 mm (Switcher) 432 x 252 x 88 mm (Main Unit)
<b>Weight</b>	7.1 kg
<b>Power</b>	Main Unit: DC 12V 126W Control Panel: DC 12V 17.3W
<b>Operating Temperature</b>	0 - 40°C [32 - 104°F]

## Service & Support

It is our goal to make owning and using Datavideo products a satisfying experience. Our support staff is available to assist you to set up and operate your system. Contact your local office for specific support requests. Plus, please visit [www.datavideo.com](http://www.datavideo.com) to access our FAQ section.

Please visit our website for latest manual update.

[www.datavideo.com/product/SE-4000](http://www.datavideo.com/product/SE-4000)

**datavideo**  
[www.datavideo.com](http://www.datavideo.com)



@DatavideoUSA @DatavideoIndia2016  
@DatavideoEMEA @Datavideojapan  
@DatavideoTaiwan @DatavideoLatam  
@DatavideoAsia @DatavideoBrasil



@Datavideo  
@Datavideo\_EMEA  
@Datavideo\_Taiwan



@DatavideoUSA  
@DVTWDCN



@DatavideoUSA  
@DatavideoEurope

All the trademarks are the properties of their respective owners.  
Datavideo Technologies Co., Ltd. All rights reserved 2020

Feb-07.2024  
Version E8