

# USER MANUAL

# *ProLite*

## LCD Monitor

ENGLISH

*ProLite T4362AS*  
*ProLite T5562AS*  
*ProLite T6562AS*

Thank you very much for choosing the iiyama LCD monitor for signage.  
We recommend that you take a few minutes to read this comprehensive manual carefully before installing and switching on the monitor. Please keep this manual in a safe place for your future reference.



## Dear user, we congratulate you on the purchase of your iiyama LCD.

For details on warranty and locally used pixel policies that apply directly after installation of your product please check the iiyama website.

## To report a fault, please contact your local support centre found at [www.iiyama.com/service](http://www.iiyama.com/service)

### Things to check before you call the iiyama information line

- | if the power cable is connected securely and turned on?
- | if the display has been turned on?
- | if the signal cable is connected securely and the correct input selected?
- | if the computer has been restarted with the display connected?
- | if the graphics card is correctly installed with the latest drivers possible?
- | if the correct native resolution has been selected via 'Display Properties'?
- | If the R/G/B signal configuration is correct?
- | if the displays On Screen Menu is shown?
- | if the correct brightness and contrast settings have been set?
- | if given display tolerances and compatibility have been considered?
- | if via the On Screen Menu you have performed a Factory Reset/Recall?

### Before reporting the screen defect, please prepare the following information/evidence:

- | model number \*
- | purchase receipt and serial number \*
- | name and address for collection
- | telephone/fax number, for availability during the day
- | convenient collection date (date, time)
- | short description of the defect

### Important Note:

If there is no fault found in the collected equipment after inspection, the transferring party shall incur charges for transport and administration.

If you have checked all of the above and there is still no picture, call our information line for assistance in your country.

\* see the identification plate on the back of the case.

## CE MARKING DECLARATION OF CONFORMITY

This LCD monitor complies with the requirements of the EC/EU Directive 2014/30/EU "EMC Directive", 2014/35/EU "Low Voltage Directive", 2009/125/EC "ErP Directive" and 2011/65/EU "RoHS Directive".

### Warning

This is a class A product. In a domestic environment this product may cause radio interference in which case the user may be required to take adequate measures.

IYAMA CORPORATION: Wijkmeerstraat 8, 2131 HA Hoofddorp, The Netherlands

Model No. : PLT4362 / PLT5562 / PLT6562



We recommend recycling of used product. Please contact your dealer or iiyama service center. Recycle information is obtained via the Internet, using the address: <http://www.iiyama.com>

You can access the Web page of different countries from there.

- We reserve the right to change specifications without notice.
- All trademarks used in this user manual are the property of their respective owners.

# TABLE OF CONTENTS

FOR YOUR SAFETY.....	1
SAFETY PRECAUTIONS.....	1
SPECIAL NOTES ON LCD MONITORS.....	3
CUSTOMER SERVICE.....	5
CLEANING.....	5
BEFORE YOU OPERATE THE MONITOR.....	6
FEATURES.....	6
CHECKING THE CONTENTS OF THE PACKAGE.....	6
UNPACKING.....	7
CONTROLS AND CONNECTORS : ProLite T4362AS.....	8
CONTROLS AND CONNECTORS :	
ProLite T5562AS / ProLite T6562AS.....	10
INSTALLATION.....	13
FUNCTIONS OF THE REMOTE CONTROL.....	14
PREPARING THE REMOTE CONTROL.....	15
ID REMOTE CONTROL.....	16
BASIC OPERATION.....	17
CONNECTING YOUR THE MONITOR : ProLite T4362AS.....	20
CONNECTING YOUR THE MONITOR : ProLite T5562AS.....	21
CONNECTING YOUR THE MONITOR : ProLite T6562AS.....	22
COMPUTER SETTING.....	26
OPERATING THE MONITOR.....	27
ADJUSTMENT MENU CONTENTS.....	29
STANDBY FEATURE.....	50
TROUBLE SHOOTING.....	51
RECYCLING INFORMATION.....	52
APPENDIX.....	53
SPECIFICATIONS : ProLite T4362AS.....	53
SPECIFICATIONS : ProLite T5562AS.....	54
SPECIFICATIONS : ProLite T6562AS.....	55
DIMENSIONS : ProLite T4362AS.....	56
DIMENSIONS : ProLite T5562AS.....	56
DIMENSIONS : ProLite T6562AS.....	57
COMPLIANT TIMING.....	57

# FOR YOUR SAFETY

## SAFETY PRECAUTIONS

### WARNING

#### **STOP OPERATING THE MONITOR WHEN YOU SENSE TROUBLE**

If you notice any abnormal phenomena such as smoke, strange sounds or fumes, unplug the monitor and contact your dealer or iiyama service center immediately. Further use may be dangerous and can cause fire or electric shock.

#### **NEVER REMOVE THE CABINET**

High voltage circuits are inside the monitor. Removing the cabinet may expose you to the danger of fire or electric shock.

#### **DO NOT PUT ANY OBJECT INTO THE MONITOR**

Do not put any solid objects or liquids such as water into the monitor. In case of an accident, unplug your monitor immediately and contact your dealer or iiyama service center. Using the monitor with any object inside may cause fire, electric shock or damage.

#### **INSTALL THE MONITOR ON A FLAT, STABLE SURFACE**

The monitor may cause an injury if it falls or is dropped.

#### **DO NOT USE THE MONITOR NEAR WATER**

Do not use where water may be splashed or spilt onto the monitor as it may cause fire or electric shock.

#### **OPERATE UNDER THE SPECIFIED POWER SUPPLY**

Be sure to operate the monitor only with the specified power supply. Use of an incorrect voltage will cause malfunction and may cause fire or electric shock.

#### **PROTECT THE CABLES**

Do not pull or bend the power cable and signal cable. Do not place the monitor or any other heavy objects on the cables. If damaged, the cables may cause fire or electric shock.

#### **ADVERSE WEATHER CONDITIONS**

It is advisable not to operate the monitor during a heavy thunder storm as the continual breaks in power may cause malfunction. It is also advised not to touch the plug in these circumstances as it may cause electric shock.

## CAUTION

### INSTALLATION LOCATION

Do not install the monitor where sudden temperature changes may occur, or in humid, dusty or smoky areas as it may cause fire, electric shock or damage. You should also avoid areas where the sun shines directly on the monitor.

### DO NOT PLACE THE MONITOR IN A HAZARDOUS POSITION

The monitor may topple and cause injury if not suitably located. Please also ensure that you do not place any heavy objects on the monitor, and that all cables are routed such that children may not pull the cables and possibly cause injury.

### MAINTAIN GOOD VENTILATION

Ventilation slots are provided to keep the monitor from overheating. Covering the slots may cause fire. To allow adequate air circulation, place the monitor at least 10 cm (or 4 inches) from any walls. Operating the monitor on its back, side, upside down or on a carpet or any other soft material may also cause damage.

### DISCONNECT THE CABLES WHEN YOU MOVE THE MONITOR

When you move the monitor, turn off the power switch, unplug the monitor and be sure the signal cable is disconnected. If you do not disconnect them, it may cause fire or electric shock.

### UNPLUG THE MONITOR

If the monitor is not in use for a long period of time it is recommended that it is left unplugged to avoid accidents.

### HOLD THE PLUG WHEN DISCONNECTING

To disconnect the power cable or signal cable, always pull it by the plug. Never pull on the cable itself as this may cause fire or electric shock.

### DO NOT TOUCH THE PLUG WITH WET HANDS

Pulling or inserting the plug with wet hands may cause electric shock.

### WHEN YOU INSTALL THE MONITOR ON YOUR COMPUTER

Be sure the computer is strong enough to hold the weight of the monitor, otherwise, you may damage your computer.

## OTHERS

### ERGONOMIC RECOMMENDATIONS

To eliminate eye fatigue, do not operate the monitor against a bright background or in a dark room. For optimal viewing comfort, the monitor should be just below eye level and 40-60 cm (16-24 inches) away from your eyes. When using the monitor over a prolonged time, a ten minute break every hour is recommended as looking at the screen continuously can cause eye strain.

## SPECIAL NOTES ON LCD MONITORS

- The following symptoms are normal with LCD monitors and do not indicate a problem.

### NOTE

- When you first turn on the LCD monitor, the picture may not fit in the display area because of the type of computer that is used. In this case, adjust the picture position to the correct position.
  - You may find slightly uneven brightness on the screen depending on the desktop pattern you use.
  - Due to the nature of the LCD screen, an afterimage of the previous screen may remain after switching the image, when the same image is displayed for hours. In this case, the screen is recovered slowly by changing the image or turning off the Power Switch for hours.
- This LCD cannot be used outdoors.
  - This LCD cannot be used with the screen facing upwards.
  - If you use a cable longer than the supplied one, the picture quality is not guaranteed.

## USAGE CONFIRMATION

This product is designed for optimum usage at 24hours per day.  
The monitor is compatible for usage in Landscape/Portrait applications.

## IMAGE PERSISTENCE / IMAGE STICKING

Please be aware that all LCD screens can experience Image Persistence or Image Sticking. This occurs when a residual image remains visible on a screen when static images are displayed for long periods of time. LCD Image Persistence is not permanent but constant images being displayed for a long period of time should be avoided.

To counteract Image Persistence, turn off the monitor for as long as the previous image was displayed, so if an image was on the monitor for 1 hour and there is evidence of a residual or “ghost” image, you should turn off the monitor for 1 hour in order to clear the residual image.

For all LFD products, iiyama recommends displaying moving images and utilising a moving screen saver at regular intervals whenever the screen is idle. You could also turn off the monitor when not in use to assist the prevention.

Other ways to reduce the risk of Image Persistence will be to utilise the FAN-on function (if available), Low Backlight and Low Brightness settings.

## FOR EXTENDED USE AS A PUBLIC MONITOR

### ■ Image Sticking on LCD Panel

When a static image is displayed for hours, an electric charge trace remains near the electrode inside the LCD producing a “ghost” image. (Image Persistence).

Image Persistence is not a permanent feature.

### ■ Recommendations

To prevent Image Sticking and promote longer life expectancy of monitor, we recommend the following:

1. Avoid static images displayed for long periods – change static images on continuous loop.
2. Turn off monitor when not in use, either by remote control or use Standby or Schedule functions.
3. Check the Monitor Menu Settings for "Pixel Shift" etc. and activate it when available. This will reduce the Image Sticking Effect.
4. When monitor is installed in high ambient temperature environment(s) or in an enclosed position, utilise the Cooling Fan, Screen Saver and Low Brightness functions.
5. Suitable ventilation for any monitor is an expectation of any installation – climate control systems may need to be employed.
6. We strongly recommend utilisation of active cooling with fans for long operation times or high ambient temperature environments.



## CUSTOMER SERVICE

### NOTE

- If you have to return your unit for service and the original packaging has been discarded, please contact your dealer or iiyama service center for advice or replacement packaging.

## CLEANING

### WARNING

- If you drop any materials or liquids such as water into the monitor when cleaning, unplug the power cable immediately and contact your dealer or iiyama service center.

### CAUTION

- For safety reasons, turn off the power switch and unplug the monitor before you clean it.

### NOTE

- To protect the LCD panel, do not scratch or rub the screen with a hard object.
- Never use any of the following strong solvents. These will damage the cabinet and the LCD screen.

Thinner	Benzine	Abrasive cleaner
Spray-type cleaner	Wax	Acid or Alkaline solvent

- Touching the cabinet with any product made from rubber or plastic for a long time may cause degeneration or loss of paint on the cabinet.

### CABINET

Stains can be removed with a cloth lightly moistened with a mild detergent solvent. Then wipe the cabinet with a soft dry cloth.

### LCD

Periodic cleaning with a soft dry cloth is recommended.

### SCREEN

Don't use tissue paper etc. because these will damage the LCD screen.

# BEFORE YOU OPERATE THE MONITOR

## FEATURES

- ◆ Supports Resolutions up to 3840 × 2160
- ◆ High Contrast 1200:1 (Typical: without glass) / Brightness 500cd/m<sup>2</sup> (Typical: without glass) : ProLite T4362AS / ProLite T6562AS
- ◆ High Contrast 5000:1 (Typical: without glass) / Brightness 500cd/m<sup>2</sup> (Typical: without glass) : ProLite T5562AS
- ◆ Digital Character Smoothing
- ◆ Automatic Set-up
- ◆ Stereo Speakers  
2 × 10W Stereo Speakers
- ◆ Standby Feature
- ◆ VESA Mounting Standard (200mm×200mm) Compliant : ProLite T4362AS
- ◆ VESA Mounting Standard (400mm×400mm) Compliant : ProLite T5562AS / ProLite T6562AS

## CHECKING THE CONTENTS OF THE PACKAGE

The following accessories are included in your package. Check to see if they are enclosed with the monitor. If anything is missing or damaged, please contact your local iiyama dealer or regional iiyama office.

- |                |                     |                  |
|----------------|---------------------|------------------|
| ■ Power Cable* | ■ HDMI Cable        | ■ RS-232C Cable  |
| ■ USB Cable    | ■ Remote Control    | ■ Battery (2pcs) |
| ■ Safety Guide | ■ Quick Start Guide |                  |

### CAUTION

- \* The rating of the Power Cable enclosed in 120V area is 10A/125V. If you are using a power supply higher than this rating, then a power cable with a rating of 10A/250V must be used. However, all guarantees and warranties are void for any problems or damage caused by a power cable not supplied by iiyama. An approved power cable greater or equal to H05VVVF, 3G, 0.75mm<sup>2</sup> must be used.

## UNPACKING

### CAUTION

Moving the monitor requires at least two people. If not, it may drop and could result in a serious injury.

# CONTROLS AND CONNECTORS : ProLite T4362AS

## <Back Controller>

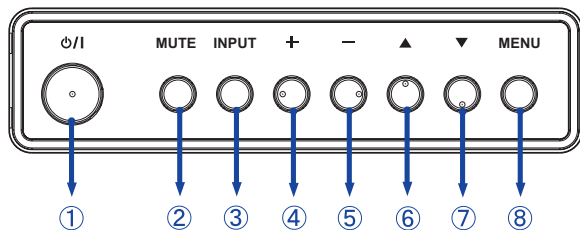

①	⏻/I	Power Button
②	MUTE	Mute Button
③	INPUT	Input Select Button
④	+	+ Button
⑤	-	- Button
⑥	▲	Up Button
⑦	▼	Down Button
⑧	MENU	Menu Button

## <Front>

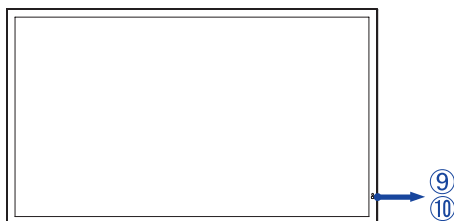

⑨	Power Indicator	Green	Lighting : Normal Operation
		Red	Lighting : If turn off the Power Button on the Remote Control and the Back Controller. Standby Mode
		Green & Red	Flash : When SCHEDULE is enabled.
		Off	Power Off
⑩	Remote Sensor		Remote Sensor

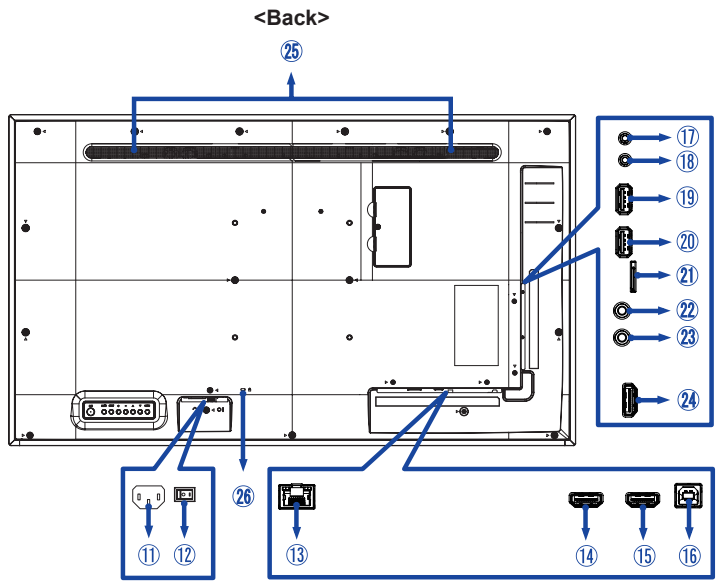

⑪	AC IN	AC-INLET	AC Connector( ~ : Alternating current) (AC-IN)
⑫	AC SWITCH I (ON) / O (OFF)	MAIN POWER	Main Power Switch
⑬	LAN	RJ45	RJ45 Connector
⑭	HDMI1 IN	HDMI	HDMI Connector
⑮	HDMI2 IN	HDMI	HDMI Connector
⑯	TOUCH	USB	USB Connector
⑰	RS232C OUT	Mini Jack	RS232C Connector
⑱	RS232C IN	Mini Jack	RS232C Connector
⑲	USB2	USB2.0 (5V, 500mA)	USB Connector
⑳	USB1	USB2.0 (5V, 500mA)	USB Connector(Service port)
㉑	MICRO SD		Micro SD slot
㉒	IR OUT	IR	IR Connector
㉓	IR IN	IR	IR Connector
㉔	HDMI3 IN	HDMI	HDMI Connector
㉕	Speakers		
㉖	Keyhole for Security Lock		

**<Back Controller>**

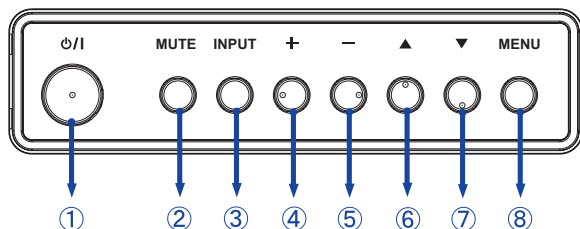

①	⏻/⏻	Power Button
②	MUTE	Mute Button
③	INPUT	Input Select Button
④	+	+ Button
⑤	-	- Button
⑥	▲	Up Button
⑦	▼	Down Button
⑧	MENU	Menu Button

**<Front>**



⑨	Power Indicator	Green	Lighting : Normal Operation
		Red	Lighting : If turn off the Power Button on the Remote Control and the Back Controller. Standby Mode
		Green & Red	Flash : When SCHEDULE is enabled.
		Off	Power Off
⑩	Remote Sensor		Remote Sensor

**<Remote sensor and power indicator - location>**

1. Pull down the lens to improve remote control performance and ensure good visibility of the power status diode.
2. Push up the lens before mounting the monitor for video wall application.
3. Pull/Push the lens until hearing the click sound.

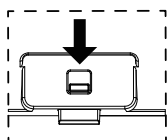

Pull down to extend the lens

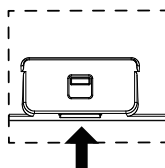

Push up to hide the lens

<Back>

■ ProLite T5562AS

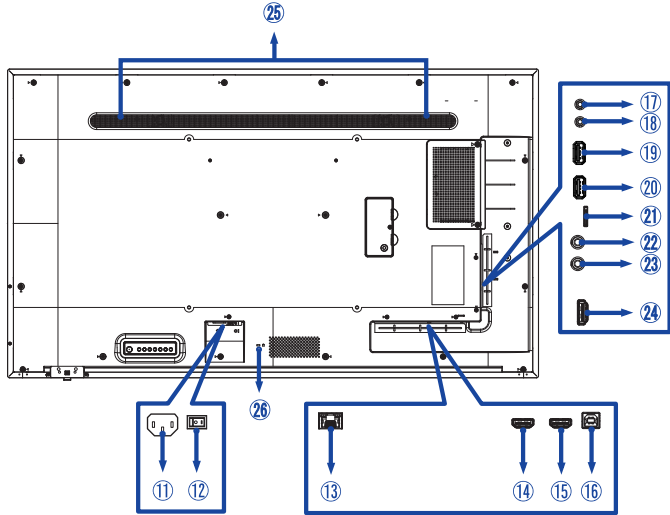

■ ProLite T6562AS

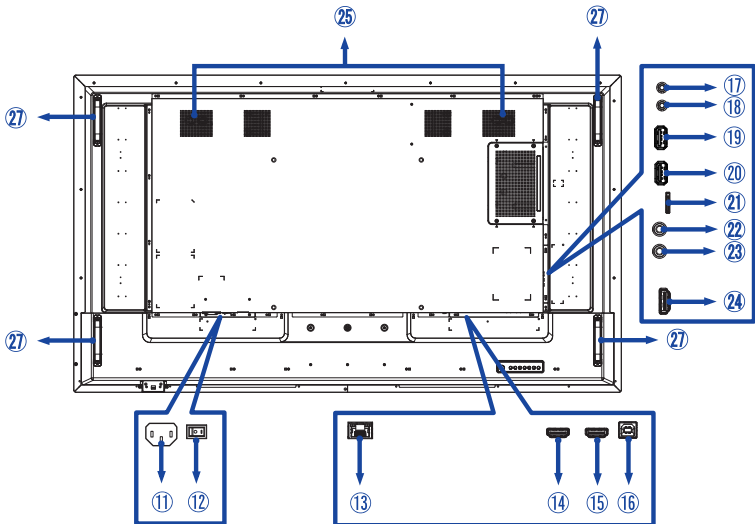

⑪	AC IN	AC-INLET	AC Connector( ~ : Alternating current) (AC-IN)
⑫	AC SWITCH I (ON) / O (OFF)	MAIN POWER	Main Power Switch
⑬	LAN	RJ45	RJ45 Connector
⑭	HDMI1 IN	HDMI	HDMI Connector
⑮	HDMI2 IN	HDMI	HDMI Connector
⑯	TOUCH	USB	USB Connector
⑰	RS232C OUT	Mini Jack	RS232C Connector
⑱	RS232C IN	Mini Jack	RS232C Connector
⑲	USB2	USB2.0 (5V, 500mA)	USB Connector
⑳	USB1	USB2.0 (5V, 500mA)	USB Connector(Service port)
㉑	MICRO SD		Micro SD slot
㉒	IR OUT	IR	IR Connector
㉓	IR IN	IR	IR Connector
㉔	HDMI3 IN	HDMI	HDMI Connector
㉕	Speakers		
㉖	Keyhole for Security Lock* <sup>1</sup>		
㉗	Handles* <sup>2</sup>		

\*<sup>1</sup> Available for ProLite T5562AS.

\*<sup>2</sup> Available for ProLite T6562AS.



## INSTALLATION

### CAUTION

- Follow the manual instructions for the type of mount you have selected. Refer all servicing to qualified service personnel.
- Moving the monitor requires at least two people.
- Before installing, please make sure the wall is strong enough to hold the necessary weight of the monitor and the mount.

### [WALL MOUNTING]

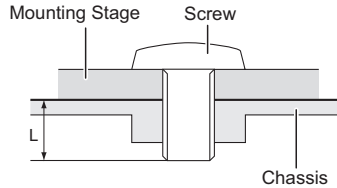

### CAUTION

When using the wall mounting, consideration of thickness of the mounting stage needs to be taken. Tighten the M6/M8\* Screws (4pcs) which "L" length is 10/15mm\* to fasten the monitor. Using a screw longer than this may cause electric shock or damage because it may contact with the electrical parts inside the monitor.

\* M6(L=10mm) : ProLite T4362AS

M6(L=15mm) : ProLite T5562AS

M8(L=15mm) : ProLite T6562AS

### [ROTATING THE MONITOR]

This monitor is designed to be compatible in both landscape and portrait modes.

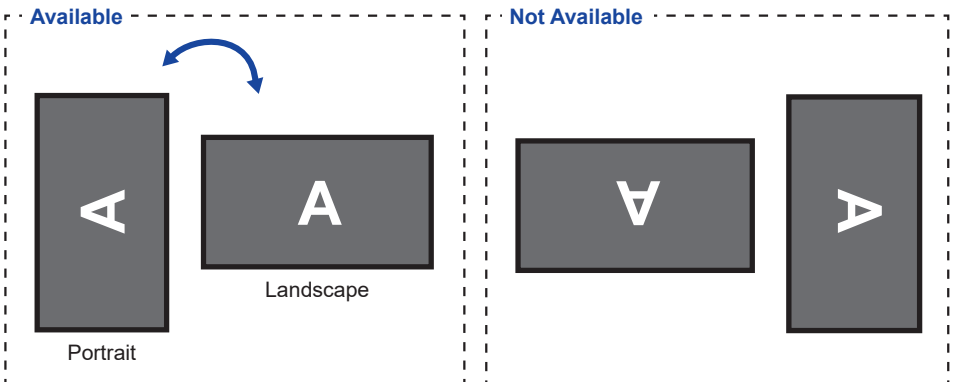

## FUNCTIONS OF THE REMOTE CONTROL

ENGLISH

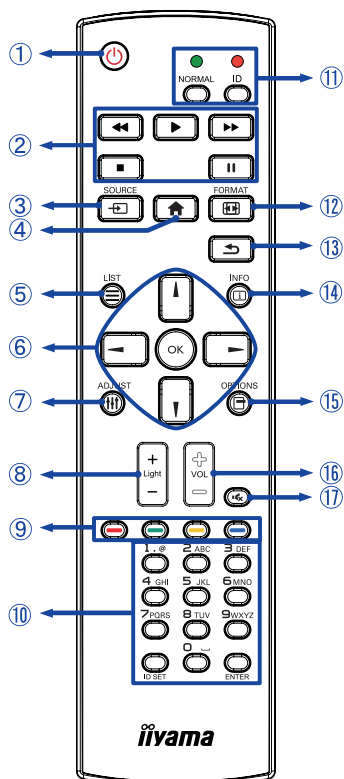

①		Turns the monitor ON and OFF.
②	[PLAY]	Control playback of media files. ▶: Play ■: Stop ⏸: Pause ◀◀: Quick-Return ▶▶: Fast-Forward
③	SOURCE	Selects the source. Press ▲ or ▼ button to select from HDMI1, HDMI2, HDMI3, Media Player, Browser, PDF Player, Custom or Home(Home mode only). Press [OK] button to confirm and exit.
④	HOME	Opens the display's on-screen menu systems.
⑤	LIST	Not available on this model.
⑥		Navigates through submenus and settings. ▲: Up Button ▼: Down Button
		◀: Left Button ▶: Right Button
	OK	Confirms your selection or save changes.
⑦	ADJUST	Not available on this model.
⑧	Light + / -	Adjust the brightness.
⑨	COLOR	Not available on this model.
⑩	NUMBER/ ID SET/ENTER	Enter text for network setting.
⑪	ID Mode	ID: To enter ID Mode NORMAL: To leave ID Mode
⑫	FORMAT	Change picture format.
⑬	BACK	Returns to a previous menu or closes the OSD Menu.
⑭	INFO	Provides source and resolution information.
⑮	OPTIONS	Not available on this model.
⑯	VOL + / -	VOLUME+: Increases the sound volume. VOLUME-: Decreases the sound volume.
⑰	MUTE	Turns on or off the mute function when the Menu is not displayed.

## PREPARING THE REMOTE CONTROL

To use the remote control, insert the two dry batteries.

### CAUTION

- Do not use any other batteries other than those specified in this manual for the Remote Control.
- Do not insert old and new batteries together in the Remote Control.
- Make sure that the terminals match the "+" and "-" indications in the battery compartment.
- Remove the dead batteries immediately to prevent them from liquid leaking into the battery compartment.
- Burst batteries or the electrolyte from these batteries may cause stains, fire or injury.

- ① Press and then slide the battery cover to open it.

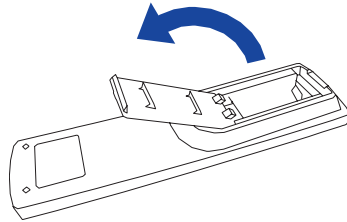

- ② Align and insert two AAA batteries according to their plus and minus ports (as indicated in the remote control).

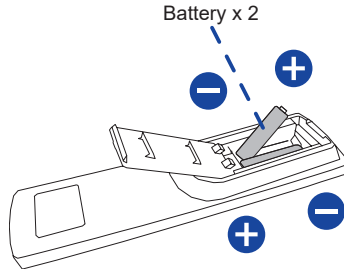

- ③ Replace the battery cover.

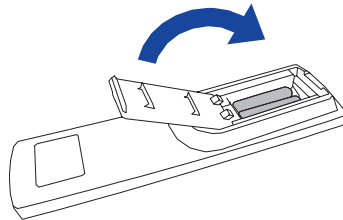

**NOTE**

- Refer to the above instructions when taking out the batteries.
- Replace with new batteries when the Remote Control does not work close to the monitor.  
Use AAA dry batteries. Risk of explosion if battery is replaced by an incorrect type.
- Operate the Remote Control by pointing it toward the Remote Sensor on the monitor.
- Other manufacturers remote control will not work with this monitor. Use the provided Remote Control ONLY.
- Used batteries needed to follow the city rule to be discarded. (suggestion: to dispose of used batteries please follow correct policy as per your council regulations)
- Batteries shall not be exposed to excessive heat such as sunshine, fire or the like.
- If you do not intend to use the remote control for a long period, remove the batteries.

**ID REMOTE CONTROL**

You can set the remote control ID when you want to use the remote control on specific monitors.

ID Mode (To enter ID Mode) : Press and hold the ID button until the red LED blinks twice.

Normal Mode (To leave ID Mode) : Press and hold the Normal button until the green LED blinks twice.

**■ Programming ID Mode**

To assign an ID to a remote control.

1. Enter ID Mode.
2. Press and hold the ID SET button until the red LED turned on.
3. Using the number button, input the desired ID. (01 - 255)
4. Press the ENTER button to confirm ID.
5. The red LED will blink twice when ID has been confirmed.
6. Press the ID SET button will exit the ID Mode. The green LED turned on.

**NOTE**

- Not pressing any button within 10 seconds will exit the ID Mode.
- If an error pressing of buttons other than the digits occurred, wait 1 second after the red LED lights off and then lights up again, then press the correct digits again.
- To cancel or stop programming an ID, press the ID SET button.
- It is necessary to set up the ID number for each monitor before selecting its ID number.

**■ Use ID Mode**

1. Enter ID Mode.
2. Input the ID of the monitor which would like to control by number button.
3. Press the ENTER button.

## BASIC OPERATION

### ■ Turning the monitor ON

The monitor is turned On and the Power Indicator turns to Green when you press the POWER button on the monitor or the Remote Control. The monitor is turned Off and the Power Indicator turns to Red when you press the POWER button on the monitor or the Remote Control. Press again to turn On the monitor.

#### NOTE

Even when using the standby mode or turning OFF the Power Switch, the monitor will consume a small amount of electricity. Disconnect the Power Cable from the power supply whenever the monitor is not in use or during the night, to avoid unnecessary power consumption.

[Monitor]

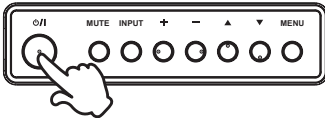

[Remote Control]

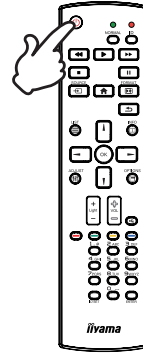

### ■ Display the adjustment menu page

The menu page appears on the screen when you press the MENU button on the monitor or the  HOME button on the Remote Control.

The menu page disappears when you press the  BACK button on the Remote Control again.

[Monitor]

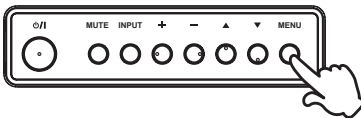

[Remote Control]

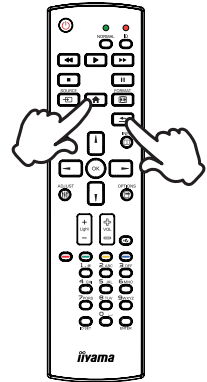

### ■ Move the cursor vertically

Select adjustment by pressing the ▲ / ▼ button on the monitor or the ▲ / ▼ button on the remote control while the menu page is displayed on the screen.

[Monitor]

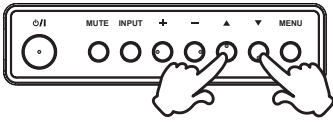

[Remote Control]

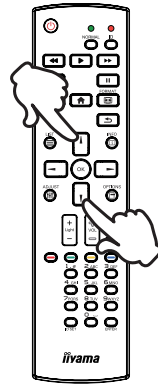

### ■ Move the cursor horizontally

Select menu or setting, or perform the adjustment by pressing the + / - button on the monitor or the ◀ / ▶ button on the remote control while the menu page is displayed on the screen.

[Monitor]

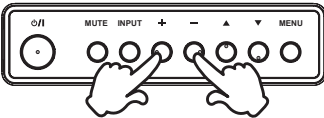

[Remote Control]

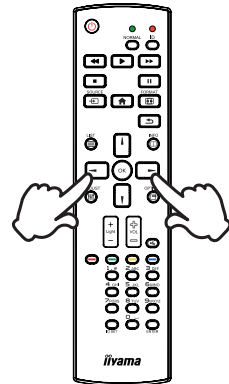

## ■ Adjust the volume of sound

Press the + / - button on the monitor or the remote control to adjust the volume of sound when the menu page is not displayed on the screen.

[Monitor]

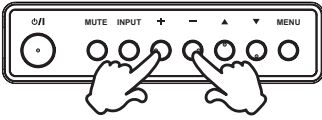

[Remote Control]

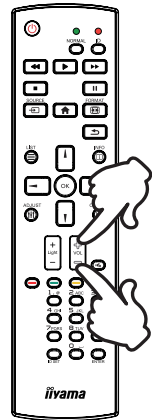

## ■ Switch the input signal

This is activated when you successively press the INPUT button on the monitor or the SOURCE button on the remote control.

[Monitor]

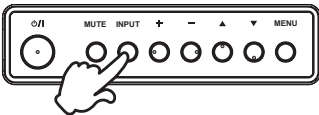

[Remote Control]

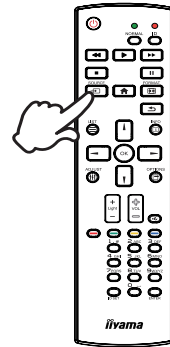

## CONNECTING YOUR THE MONITOR : ProLite T4362AS

- ① Ensure that both the computer and the monitor are switched off.
- ② Connect the computer to the monitor with the signal cable.
- ③ Connect the computer to the monitor with the RS-232C Cable.
- ④ Connect the Power Cable to the monitor first and then to the power source.
- ⑤ Turn on your monitor (Main Power Switch and Power Switch) and computer.

### NOTE

- Make sure that the building installation has a circuit breaker of 120/240V, 20A (maximum).
- The signal cables used for connecting the computer and monitor may vary with the type of computer used. An incorrect connection may cause serious damage to both the monitor and the computer. The cable supplied with the monitor is for a standard connector. If a special cable is required please contact your local iiyama dealer or regional iiyama office.
- Make sure you tighten the finger screws at each end of the Signal Cable.
- The Class I pluggable equipment Type A must be connected to protective earth.
- The socket-outlet shall be installed near the equipment and shall be easily accessible.

[Example of Connection]

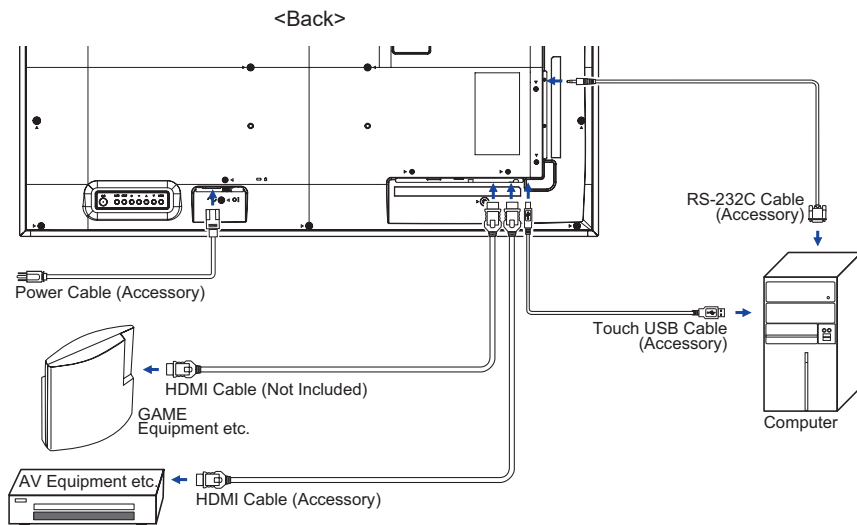



## CONNECTING YOUR THE MONITOR : ProLite T5562AS

- ① Ensure that both the computer and the monitor are switched off.
- ② Connect the computer to the monitor with the signal cable.
- ③ Connect the computer with the RS-232C Cable from the monitor.
- ④ Connect the Power Cable to the monitor first and then to the power source.
- ⑤ Turn on your monitor (Main Power Switch and Power Switch) and computer.

### NOTE

- Make sure that the building installation has a circuit breaker of 120/240V, 20A (maximum).
- The signal cables used for connecting the computer and monitor may vary with the type of computer used. An incorrect connection may cause serious damage to both the monitor and the computer. The cable supplied with the monitor is for a standard connector. If a special cable is required please contact your local iiyama dealer or regional iiyama office.
- Make sure you tighten the finger screws at each end of the Signal Cable.
- The Class I pluggable equipment Type A must be connected to protective earth.
- The socket-outlet shall be installed near the equipment and shall be easily accessible.

[Example of Connection]

<Back>

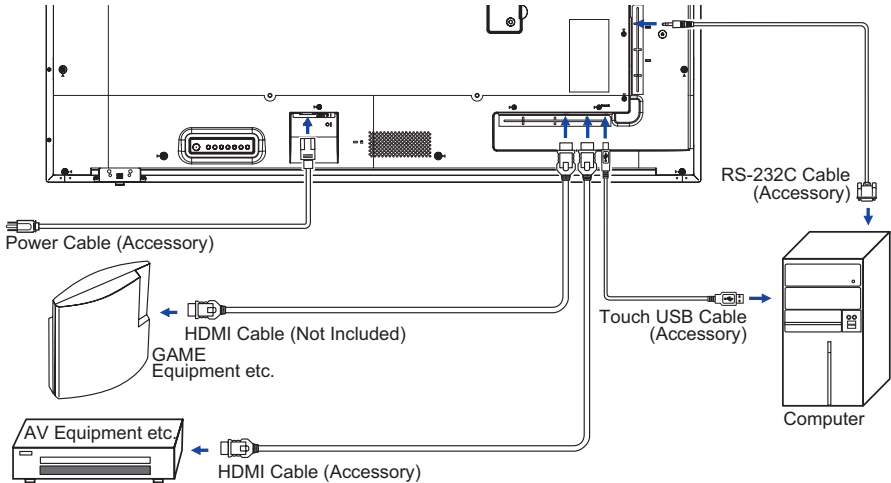

## CONNECTING YOUR THE MONITOR : ProLite T6562AS

- ① Ensure that both the computer and the monitor are switched off.
- ② Connect the computer to the monitor with the signal cable.
- ③ Connect the computer with the RS-232C Cable from the monitor.
- ④ Connect the Power Cable to the monitor first and then to the power source.
- ⑤ Turn on your monitor (Main Power Switch and Power Switch) and computer.

### NOTE

- Make sure that the building installation has a circuit breaker of 120/240V, 20A (maximum).
- The signal cables used for connecting the computer and monitor may vary with the type of computer used. An incorrect connection may cause serious damage to both the monitor and the computer. The cable supplied with the monitor is for a standard connector. If a special cable is required please contact your local iiyama dealer or regional iiyama office.
- Make sure you tighten the finger screws at each end of the Signal Cable.
- The Class I pluggable equipment Type A must be connected to protective earth.
- The socket-outlet shall be installed near the equipment and shall be easily accessible.

[Example of Connection]

<Back>

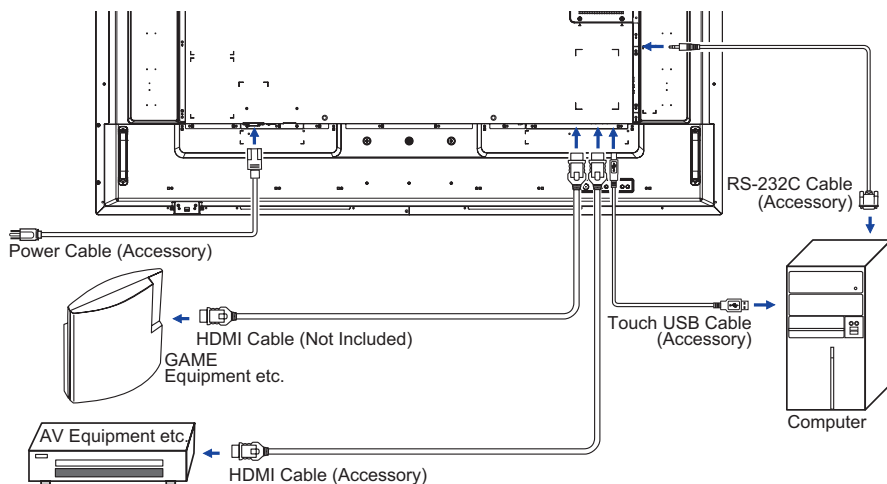

## [ Connection example with the peripheral device ]

### CAUTION

Turn off the power switch and unplug the monitor and peripherals before connection to avoid electric shock or damage.

### NOTE

- Refer to the user manual of peripherals at the same time.
- Ensure you have the necessary cables as required.

### ■ ProLite T4362AS

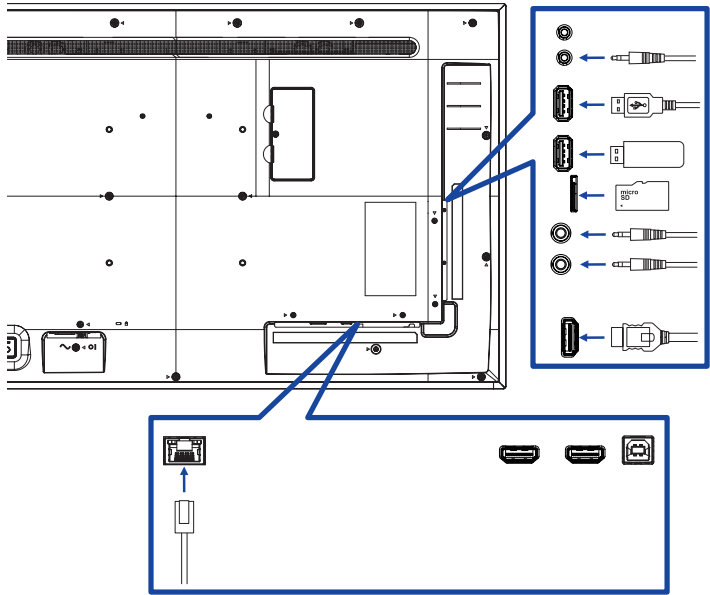

■ ProLite T5562AS

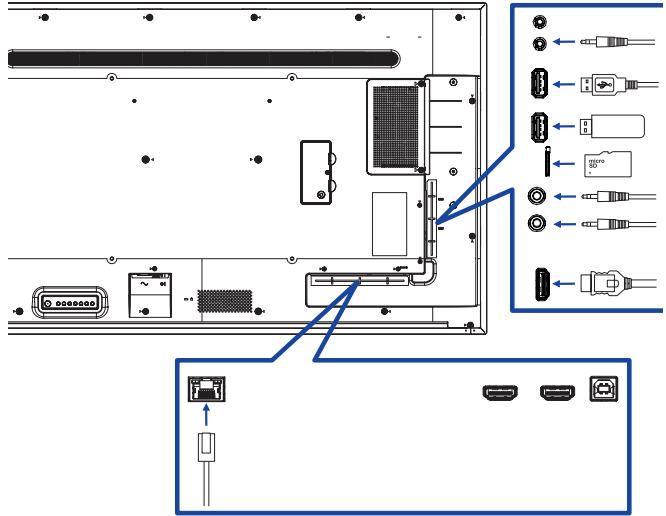

■ ProLite T6562AS

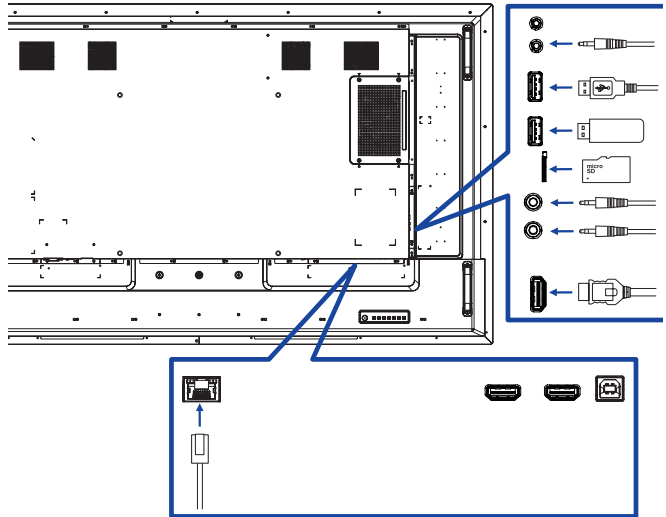

## [ About the daisy chain ]

### ■ Monitor control connection

#### RS-232C

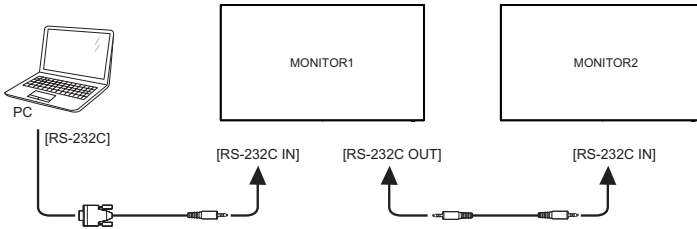

## [ To setup the network ]

1. Switch on the router and switch on its DHCP setting.
2. Connect the router to this monitor with an Ethernet cable.
3. Press  HOME button on the remote control, then select Setup.
4. Select "Connect to network", then press OK button.
5. Follow the on-screen instructions to install the network.
6. Wait for this monitor to find the network connection.
7. If you are prompted, agree to the "End User Licence Agreement".

**NOTE** Connecting with a shielded CAT-5 Ethernet cable to comply with the EMC directive.

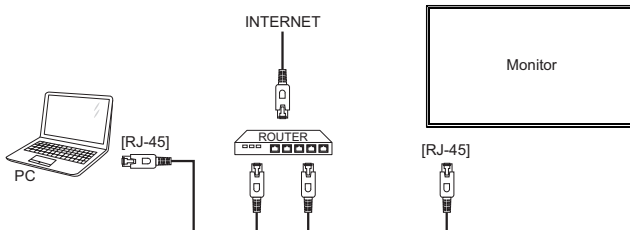

## COMPUTER SETTING

### ■ Signal Timing

Change to the desired signal timing listed on page 57: COMPLIANT TIMING.

### ■ Windows XP/Vista/7/8/8.1/10 Plug & Play

The iiyama LCD monitor complies with DDC2B of VESA standard. The Plug & Play function runs on Windows XP/Vista/7/8/8.1/10 by connecting the monitor to DDC2B compliant computer with the Signal Cable supplied.

For installation on Windows XP: The monitor Information File for iiyama monitors may be necessary for your computer and obtained via the Internet, using the address:

<http://www.iiyama.com>

### NOTE

- Monitor Drivers are not required in most cases for Macintosh or Unix operating systems. For further information, please contact your computer dealer first for advice.

### ■ Procedure for turning ON the Power Switch

Turn ON the monitor first, and then the computer.

# OPERATING THE MONITOR

To create the best picture, your iiyama LCD monitor has been preset at the factory with the COMPLIANT TIMING shown on page 57. You are also able to adjust the picture by following the button operation shown below.

- 1 Press the **HOME** button on the remote control or the **MENU** button on the monitor to start the On Screen Display feature. There are additional Menu items which can be switched by using the **▲ / ▼** buttons on the remote control or the **▲ / ▼** buttons on the monitor.

Picture	Brightness	80
Screen	Contrast	50
Audio	Sharpness	10
Configuration 1	Black level	50
Configuration 2	Tint	50
Advanced option	Color	55
Android Settings	Noise reduction	Off
Display Mode	Gamma selection	Native
	Color temperature	Native
	Color control	Action
	Smart power	Off
	Overscan	Off

- 2 Select the Menu item of the adjustment you want to make. Press the **OK** button on the remote control or the **+** button on the monitor and enter the menu page. Then, use the **▲ / ▼** buttons on the remote control or the **▲ / ▼** buttons on the monitor to highlight the desired adjustment item.
- 3 Press the **OK** button on the remote control or the **+** button on the monitor again. Use the **◀ / ▶** buttons on the remote control or the **+ / -** buttons on the monitor to make the appropriate adjustment or setting.
- 4 Press the **BACK** button on the remote control or the **MENU** button on the monitor to leave the menu, and the settings you just made would be automatically saved.

For example, to correct for OSD vertical position, select Menu item of "Configuration 2". Press the **OK** button on the remote control or the **+** button on the monitor. Then, select "OSD V Position" by using the **▲ / ▼** buttons on the remote control or the **▲ / ▼** buttons on the monitor.

Picture	OSD turn off	45
Screen	OSD H position	50
Audio	OSD V position	50
Configuration 1	System Rotation	Landscape
Configuration 2	Information OSD	10
Advanced option	Logo	On
Android Settings	Monitor ID	Action
Display Mode	Heat status	40.13°C 104.22°F
	Monitor information	Action
	HDMI Version	2.0
	Configuration2 reset	Action

Use the **◀ / ▶** buttons on the remote control or the **+ / -** buttons on the monitor to change the OSD vertical position settings. The OSD vertical position of the overall monitor should be changing accordingly while you are doing this.



Press the **BACK** button on the remote control or the **MENU** button on the monitor lastly, it ends, all changes are saved in the memory.

## NOTE

- The  BACK button on the remote control or the + button on the monitor can be used to return previous menu item.
- Any changes are automatically saved in the memory when the On Screen Display disappears. Turning off the power should be avoided while using the Menu.
- All adjustments have only one setting which applies to all signal timings.

























**Direct** \* Available for Remote Control only.

You can skip the Menu items and directly display an option setting screen by using the following button operations.

- **Zoom mode:**  
Press the FORMAT Button when the Menu is not displayed.



# ADJUSTMENT MENU CONTENTS

Picture		<table border="1"> <tr> <td>Picture</td> <td>Brightness</td> <td>80</td> </tr> <tr> <td>Screen</td> <td>Contrast</td> <td>50</td> </tr> <tr> <td>Audio</td> <td>Sharpness</td> <td>10</td> </tr> <tr> <td>Configuration 1</td> <td>Black level</td> <td>50</td> </tr> <tr> <td>Configuration 2</td> <td>Tint</td> <td>50</td> </tr> <tr> <td>Advanced option</td> <td>Color</td> <td>55</td> </tr> <tr> <td>Android Settings</td> <td>Noise reduction</td> <td>Off</td> </tr> <tr> <td>Display Mode</td> <td>Gamma selection</td> <td>Native</td> </tr> <tr> <td></td> <td>Color temperature</td> <td>Native</td> </tr> <tr> <td></td> <td>Color control</td> <td>Action</td> </tr> <tr> <td></td> <td>Smart power</td> <td>Off</td> </tr> <tr> <td></td> <td>Overscan</td> <td>Off</td> </tr> </table>		Picture	Brightness	80	Screen	Contrast	50	Audio	Sharpness	10	Configuration 1	Black level	50	Configuration 2	Tint	50	Advanced option	Color	55	Android Settings	Noise reduction	Off	Display Mode	Gamma selection	Native		Color temperature	Native		Color control	Action		Smart power	Off		Overscan	Off
Picture	Brightness	80																																					
Screen	Contrast	50																																					
Audio	Sharpness	10																																					
Configuration 1	Black level	50																																					
Configuration 2	Tint	50																																					
Advanced option	Color	55																																					
Android Settings	Noise reduction	Off																																					
Display Mode	Gamma selection	Native																																					
	Color temperature	Native																																					
	Color control	Action																																					
	Smart power	Off																																					
	Overscan	Off																																					
Adjustment Item	Problem / Option		Button to Press																																				
Brightness* <sup>1</sup>	Too dark Too bright		   																																				
Contrast* <sup>3</sup>	Too dull Too intense		   																																				
Sharpness* <sup>3</sup>	Too soft Too sharp		   																																				
Black level* <sup>3</sup>	Black is too dark Black is too bright		   																																				
Tint* <sup>3</sup>	Purplish Greenish		   																																				
Color* <sup>3</sup>	Too weak Too strong		   																																				
Noise reduction* <sup>3</sup>	Off	Noise Reduction is turned off.																																					
	Low	Electronic image noise caused by different media players is reduced.																																					
	Medium	Electronic image noise caused by different media players is reduced more than Low.																																					
	High	Electronic image noise caused by different media players is reduced more than Medium.																																					
Gamma selection* <sup>2,3</sup>	You can set the Gamma. Native / 2.2 / 2.4 / s gamma / D-image																																						
Color temperature* <sup>3</sup>	3000°K	9300°K																																					
	4000°K	10000°K																																					
	5000°K	Native	Original color temperature																																				
	6500°K	User 1	User preset 1																																				
	7500°K	User 2	User preset 2																																				

Picture	
Picture	Contrast 50
Screen	Sharpness 10
Audio	Black level 50
Configuration 1	Tint 50
Configuration 2	Color 55
Advanced option	Noise reduction Off
Android Settings	Gamma selection Native
Display Mode	Color temperature Native
	Color control Action
	Smart power Off
	Overscan Off
	Picture reset Action

Adjustment Item	Problem / Option		Button to Press
Color control*4	Set user color.		
	User-R	Too weak Too strong	
	User-G		
	User-B		
	2000K-10000K		
Smart power	Off	Normal	
	Midium	Brightness of back-light is reduced. (80%)	
	High	Brightness of back-light is reduced more than Midium. (65%)	
Overscan*3	Off	Over scan is turned off.	
	On	Display area about 95%.	
Picture reset	Cancel	Return to Menu.	
	Reset	Picture setting will be restored to factory-preset data.	

\*1 Adjust the Brightness when you are using the monitor in a dark room and feel the screen is too bright. Brightness adjustment is disabled when Brightness of Panel saving is on.

\*2 Press ▼ to display the options.

\*3 Not available for Media Player, Browser, PDF Player and Custom inputs.

\*4 Only color temperature set user 1 & 2 can be use.

Screen	
Picture	Zoom mode
Screen	Custom zoom
Audio	Screen reset
Configuration 1	Full
Configuration 2	Action
Advanced option	Action
Android Settings	
Display Mode	





















Adjustment Item	Problem / Option	
Zoom mode	Full*	Enlarge the picture horizontally to fill the screen if the picture source is 4:3 (standard definition). When the picture source is 16:9 (high definition), it is not scaled.
	4:3*	Display all pictures in 4:3 aspect ratio.
	Real*	Display the picture dot by dot.
	21:9*	Display all pictures in 21:9 aspect ratio.
Custom zoom	Zoom	for Analog and Digital input.
	H Zoom	for Analog and Digital input.
	V Zoom	for Analog and Digital input.
	H position	for Analog and Digital input, by Zoom / H Zoom values.
	V position	for Analog and Digital input, by Zoom / V Zoom values.
Screen reset	Cancel	Return to Menu.
	Reset	Screen setting will be restored to factory-preset data.

\* Not available in Media Player, Browser, PDF Player, Custom (all Android source). Not available when Tiling enable.

# Audio

Picture	Balance	50
Screen	Treble	50
<b>Audio</b>	Bass	50
Configuration 1	Volume	20
Configuration 2	Maximum volume	100
Advanced option	Minimum volume	0
Android Settings	Mute	Off
Display Mode	Audio reset	Action

ENGLISH

Adjustment Item	Problem / Option		Button to Press
Balance	Left side speaker is louder. Right side speaker is louder.		   
Treble	Too weak Too strong		   
Bass	Too weak Too strong		   
Volume	Too soft Too loud		   
Maximum volume	Set the maximum volume.		 
Minimum volume	Set the minimum volume.		 
Mute	Off	Return the sound volume to the previous level.	
	On	Turn off the sound temporarily.	
Audio reset	Cancel	Return to Menu.	
	Reset	Audio setting will be restored to factory-preset data.	

## Configuration1

Picture	Switch on state	Force on
Screen	Panel saving	Action
Audio	RS232 routing	RS232
Configuration 1	Boot on source	Action
Configuration 2	WOL	Off
Advanced option	RGB Range	Auto
Android Settings	Configuration1 reset	Action
Display Mode	Factory reset	Action

Adjustment Item	Problem / Option		
Switch on state	Power off	The monitor will remain off when the power cord is connected to a wall outlet.	
	Forced on	The dmonitor will turn on when the power cord is connected to a wall outlet.	
	Last status	The monitor will return to the previous power status (on/off/standby) when removing and replacing the power cord.	
Panel saving	Cooling fan	Auto	The fan turns on automatically when the monitor's internal temperature reaches 45°C or higher.
		Off	Fan speed turns off.
		Low	Fan speed set low.
		Medium	Fan speed set medium.
		High	Fan speed set high.
	Brightness	Off	Brightness is turned off.
		On	The image brightness will be reduced to an appropriate level.
	Pixel shift*1	For the monitor to slightly expand the image size and shift the position of pixels in four directions (up, down, left or right).	
		Off	Pixel shift is turned off.
		Auto	Move the position of the image automatically.
	10-900	Move the position of the image at set intervals.	
RS232-routing	Select the network control port. RS232 / LAN → RS232		
Boot on source*1,2	Last input	When the power is turned on, it starts with the same setting as when the power was last turned off. Disable / Enable	
	Input	Select input source when boot up. HDMI1 / HDMI2 / HDMI3 / Media Player / Browser / Nsign / PDF Player / Custom / Home (Home is only in Home mode.)	
	Playlist	Select playlist index for Mediaplayer, Browser and PDF player.	

## Configuration1

Picture	Switch on state	Force on
Screen	Panel saving	Action
Audio	RS232 routing	RS232
Configuration 1	Boot on source	Action
Configuration 2	WOL	Off
Advanced option	RGB Range	Auto
Android Settings	Configuration1 reset	Action
Display Mode	Factory reset	Action

Adjustment Item	Problem / Option	
WOL	Off	Disable wake on LAN function.
	On	Enable wake on LAN function.
RGB Range	Auto	Auto switch between limited and full RGB based on content.
	Full Range	Not recommended to select this option.
	Limited Range	Not recommended to select this option.
Configuration1 reset	Cancel	Return to Menu.
	Reset	Configuration1 setting will be restored to factory-preset data.
Factory reset	Cancel	Return to Menu.
	Reset	Factory-preset data is restored.

\*1 No failover function, system will keep source even the source is no signal input.

\*2 Press ▼ to display the options.

Adjustment Item		Problem / Option	Button to Press																						
<div style="display: flex; justify-content: space-between;"> <div style="width: 30%;"> <p><b>Configuration2</b></p> <ul style="list-style-type: none"> <li>Picture</li> <li>Screen</li> <li>Audio</li> <li>Configuration 1</li> <li style="background-color: #00aaff; color: white;">Configuration 2</li> <li>Advanced option</li> <li>Android Settings</li> <li>Display Mode</li> </ul> </div> <div style="width: 65%; background-color: #333; color: white; padding: 5px;"> <table border="0" style="width: 100%; border-collapse: collapse;"> <tr><td>OSD turn off</td><td>45</td></tr> <tr><td>OSD H position</td><td>50</td></tr> <tr><td>OSD V position</td><td>50</td></tr> <tr><td>System Rotation</td><td>Landscape</td></tr> <tr><td>Information OSD</td><td>10</td></tr> <tr><td>Logo</td><td>On</td></tr> <tr><td>Monitor ID</td><td>Action</td></tr> <tr><td>Heat status</td><td>40.13°C 104.22°F</td></tr> <tr><td>Monitor information</td><td>Action</td></tr> <tr><td>HDMI Version</td><td>2.0</td></tr> <tr><td>Configuration2 reset</td><td>Action</td></tr> </table> </div> </div>				OSD turn off	45	OSD H position	50	OSD V position	50	System Rotation	Landscape	Information OSD	10	Logo	On	Monitor ID	Action	Heat status	40.13°C 104.22°F	Monitor information	Action	HDMI Version	2.0	Configuration2 reset	Action
OSD turn off	45																								
OSD H position	50																								
OSD V position	50																								
System Rotation	Landscape																								
Information OSD	10																								
Logo	On																								
Monitor ID	Action																								
Heat status	40.13°C 104.22°F																								
Monitor information	Action																								
HDMI Version	2.0																								
Configuration2 reset	Action																								
OSD turn off	You can set the OSD display duration time between 5 and 120 seconds. Off / 5 - 120 seconds																								
OSD H position	OSD is too left OSD is too right																								
OSD V position	OSD is too low OSD is too high																								
System Rotation	Landscape	Display the OSD in Landscape mode.																							
	Portrait	Display the OSD in Portrait mode.																							
Information OSD	Set the period of time the information OSD is displayed on the upper right corner of the screen. Off / 1 - 60 seconds																								
Logo	Off	iiyama Logo does not display when the monitor is turned on.																							
	On	iiyama Logo displayed when the monitor is turned on.																							
	User*1	Custom logo option in android is set, there will be only Custom logo when the monitor is turned on.																							
Monitor ID	Monitor ID	Set ID to the monitor. 1 - 255																							
	Monitor group	Set group to the Monitor. 1 - 254																							
Heat status	This function allows you to check the thermal status of the display at any time.																								
Monitor information	Shows information about your monitor, including Model name, Serial No., Operation hours and SW version.																								
HDMI Version*2	Set the version of the HDMI. 1.4 / 2.0																								
Configuration2 reset	Cancel	Return to Menu.																							
	Reset	Configuration2 setting will be restored to factory-preset data.																							

\*1 When you would like to use a Custom Boot Logo, go to Settings → Signage Display → General settings and set Boot Logo.

\*2 Suitable for HDMI input only.

## Advanced option

Picture	IR control	Unlock
Screen	Power LED Light	On
Audio	Keyboard control	Unlock
Configuration 1	Off timer	Off
Configuration 2	Date and time	Action
Advanced option	Schedule	Action
Android Settings	HDMI with One Wire	Off
Display Mode	HDMI One Wire Power Off	Off
	Auto signal detection	Off
	Language	English
	OSD transparency	Off
	Power Save	Mode 1

Adjustment Item	Problem / Option	
IR control	Select the operation mode of the remote control when multiple monitors are connected via an RS232C connection.	
	Unlock* <sup>1</sup>	Unlock the remote control.
	Lock All	Lock all of the remote control.
	Lock all but Volume	Lock all except the volume of the remote control.
	Lock all but Power	Lock all except the power of the remote control.
	Lock all except PWR & VOL	Lock all except the volume and power of the remote control.
	Primary	Set the monitor as the primary monitor for remote control operation.
	Secondary	Set the monitor as the secondary monitor. This monitor can not be operated by the remote control, and will only receive the control signal from the primary monitor via the RS232C connection.
Power LED light	Off	The Power Indicator is turned Off.
	On	The Power Indicator is turned On.
Keyboard control	Lock the keyboard function. (Control buttons)	
	Unlock* <sup>2</sup>	Unlock the keyboard.
	Lock All	Lock all of the keyboard.
	Lock all but Volume	Lock all except the volume of the keyboard.
	Lock all but Power	Lock all except the power of the keyboard.
	Lock all except PWR & VOL	Lock all except the volume and power of the keyboard.
Off Timer	Set automatic power off time. (in hours)	
Date and time	Set the Date and Time. Use 24-Hour Format, Automatic Date & Time, Date Format, Timezone.	

\*<sup>1</sup> To unlock, press and hold the INFO button on the remote control for 6 seconds.

\*<sup>2</sup> To unlock, hold the + button and ▲ button on the monitor for more than 3 seconds, it will lock/unlock the control button function.



## Advanced option

Picture	IR control	Unlock
Screen	Power LED Light	On
Audio	Keyboard control	Unlock
Configuration 1	Off timer	Off
Configuration 2	Date and time	Action
<b>Advanced option</b>	Schedule	Action
Android Settings	HDMI with One Wire	Off
Display Mode	HDMI One Wire Power Off	Off
	Auto signal detection	Off
	Language	English
	OSD transparency	Off
	Power Save	Mode 1

Adjustment Item	Problem / Option		
Schedule	Schedule list	Up to 7 schedules can be set.	
	Schedule 1/2/3/4/ 5/6/7	Enable	Enable / disable schedule. <b>NOTE</b> If set with other schedule list conflict, you can not enable schedule.
		Start time	Set start time.
		End time	Set end time.
		Input	Select default input source to use when the monitor is automatically turned on next time. HDMI1 / HDMI2 / HDMI3 / Media Player / Browser / PDF Player / Custom / Home(Home mode only)
		Playlist 1/2/3/4/5/6/7	Choose playlist (1 - 7) for the mediaplayer, PDF player and browser.
		Days of the week	Set the day of the week. Sun / Mon / Tue / Wed / Thu / Fri / Sat
		Every week	Set whether to repeat every week.
	Back	Does not change schedule data.	
	Save	Save schedule data.	
HDMI with One Wire	Off	HDMI with One Wire is turned off.	
	On	Control all devices connected by HDMI cable with one remote control.	
HDMI with One Wire Power Off* <sup>3</sup>	Off	HDMI with One Wire Power Off is turned off.	
	On	Use the power button on the device connected with the HDMI cable to switch to standby mode.	
Auto signal detection* <sup>4</sup>	Off	Disable the Auto signal detection.	
	All* <sup>5</sup>	Detects all sources automatically if there is no signal on the default input and selects the available signal automatically.	
	Failover	Detects sources automatically with user-defined order if there is no signal on the default input and selects the available signal automatically.	



\*<sup>3</sup> It can be used only when HDMI with One Wire turn on.

\*<sup>4</sup> The display detects and select available signal source automatically.

\*<sup>5</sup> Order of detection: HDMI1 → HDMI2 → HDMI3 → Media Player → Browser → PDF Player → Custom → Home(Home mode only)

## Advanced option

Picture	Power LED Light	On
Screen	Keyboard control	Unlock
Audio	Off timer	Off
Configuration 1	Date and time	Action
Configuration 2	Schedule	Action
Advanced option	HDMI with One Wire	Off
Android Settings	HDMI One Wire Power Off	Off
Display Mode	Auto signal detection	Off
	Language	English
	OSD transparency	Off
	Power Save	Mode 1
	Advanced option reset	Action

Adjustment Item	Problem / Option				Button to Press	
Language	English	English	Svenska	Swedish		
	Español	Spanish	Türkçe	Turkish		
	Français	French	Русский	Russian		
	Italiano	Italian	العربية	Arabic		
	Latviešu	Latvian	简体中文	Simplified Chinese		
	Lietuvių	Lithuania	繁體中文	Traditional Chinese		
	Nederlands	Dutch	日本語	Japanese		
	Norsk bokmål	Norwegian	Čeština	Czech		
	Polski	Polish	Dansk	Danish		
	Português	Portuguese	Deutsch	German		
	Suomi	Finnish	Eesti	Estonia		
OSD Transparency	The background of OSD is made transparent. Off / 1 - 100					
Power Save		Power button off	No signal	WOL	Android	
	Mode1	DC off	DC off	On	ARM off	
	Mode2	DC off	Backlight off	On	ARM off	
	Mode3	Backlight off	Backlight off	Off	ARM off	
	Mode4	Backlight off	Backlight on, show "no signal"	Off	ARM off	
Advanced option reset	Cancel	Return to Menu.				
	Reset	Advanced option setting will be restored except "Date and Time" in the Advanced option menu to factory-preset data.				

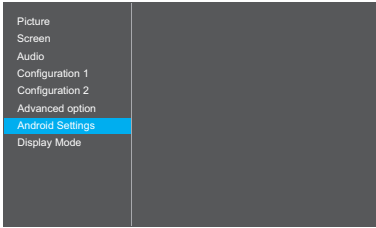
<b>Android Settings</b>			
Adjustment Item	Problem / Option		
Android Settings	Android Settings will show Networks & Internet / Signage Display / Apps / Display / Security / System		

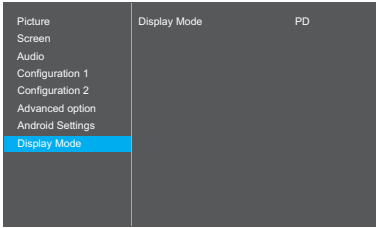
<b>Display Mode</b>			
Adjustment Item	Problem / Option		
Display Mode	Display Mode	Home	Home mode will show icons: Whiteboard / FileManager / Apps.
		PD	PD mode will show HDMI1.

# APPLICATION

Press the  HOME button and number 1668 on the remote control.

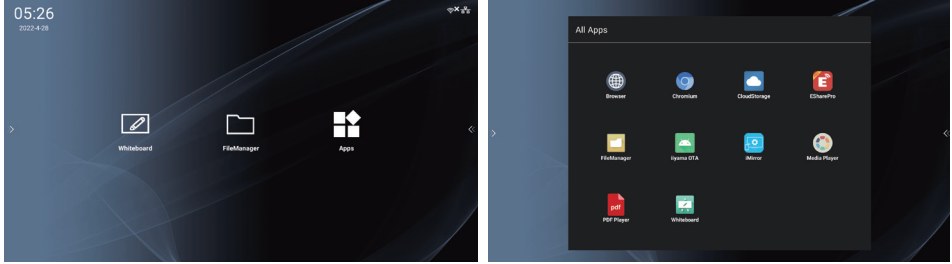

ENGLISH

## ■ Navigation toolbar appears









The navigation toolbar can be displayed on either left side or right side of the screen.

Operations are defined as follows:

1. Click to expand the side bar (only one side will expand).
2. Press and hold to move up and down, and the icons on both sides will move vertically at the same time.

### NOTE

Navigation bar only works on Home mode.

	<b>Hide:</b> Hide side bar.
	<b>Home Mode (Launcher):</b> Open Home side bar.
	<b>Source:</b> Open source menu.
	<b>OSD Menu:</b> Open OSD menu.
	<b>Touch lock password:</b> Open Touch lock password setting.
	<b>Clean:</b> 1.Clear Cloud Drive Account history. 2.Clear Whiteboard data. 3.Clear Chromium history.
	<b>Recents:</b> Open recent apps.
	<b>Back:</b> Return to the previous page or exit from the previous function.

## <Settings>

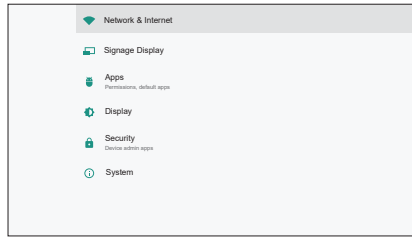

Adjustment Item	Problem / Option			
Networks & Internet	Wi-Fi	Wi-Fi preference (WPS Push Button/ WPS Pin Entry/ MAC address/ IP address) / Saved networks.		
	Ethernet	Set the wired network. Disable / Enable (Connection Type: DHCP/Static IP/IP Address/Netmask/DNS Address/Gateway, MAC Address)		
	Mobile network	Data roaming / Preferred network type / Access Point Names / Network operators		
	Mobile plan	This item will only be displayed when the 4G module is plugged in.		
	Mobile data	This item will only be displayed when the 4G module is plugged in, After opening you can surf the Internet through 4G.		
Signage Display	General settings	Signage Display name	Set the monitor name Ethernet Mac Address.	
		Boot Logo* <sup>1</sup>	Select Boot Animation* <sup>2</sup>	
		Screenshot	Disable / Enable(Interval, Start time, End time, Repeat, Save to, Purge Screenshots, Send screenshots via email)	
		Navigation bar	Set the side bar always on / off / auto hide.	
	Server settings	Email Notification	Disable / Enable(SMTP, Manager Email, Test)	
		FTP	Disable / Enable(Account, Password, Storage Path, Port)	
		Remote control	Enable / Disable the remote control service.	
		SNMP	Enable / Disable SNMP service.	
		ADB Over Network	Access network connection with port 5555.	
	Source settings	Androud source	Media Player	Edit Media Player playlist and effect settings.
			Browser	Edit Bookmark configuration.
			PDF Player	Edit PDF Player playlist and effect settings.
Custom app			Edit the Custom app.	

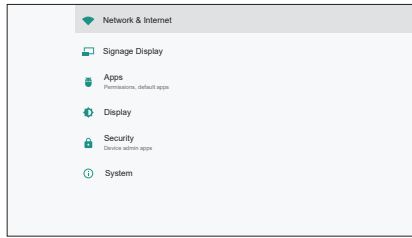

Adjustment Item	Problem / Option					
Signage Display	Network application	Proxy	Set the proxy server. Disable / Enable (Hostname: Proxy server IP Address, Port: Proxy server port number, Type: Proxy server type) Authentication / Username / Password			
		OTSP Network Port	Change the OTSP Network Port.			
	System tools	Clear Storage	Clear all data in signage folders. All / Internal storage / USB storage / SD card			
		Reset	Factory Reset	Cancel	Return to Menu.	
			OK	Factory-preset data is restored.		
		Auto restart	Disable / Enable			
		Import & Export	Export signage Display settings		Export to signage folder under USB/SD. USB storage / SD card	
			Import signage Display settings		Import from signage folder under USB/SD. USB storage / SD card	
		Clone	Clone Media File		Copy the media file from internal, USB or SD folder.	
		Security	External Storage	Disable	SD card / USB External Storage unlock.	
				Enable	SD card / USB External Storage lock.	
	Admin Password	Enable		Click the checkbox to Enable / Disable.		
		Modify Password		Change the password.		
Reset Password		Reset the password to default value.				

\*1 The Boot Logo is only available when you select "User" of Logo function in the OSD menu "Configuration2".

\*2 For details, refer to download the Custom Boot Animation manual on the IYAMA web site.

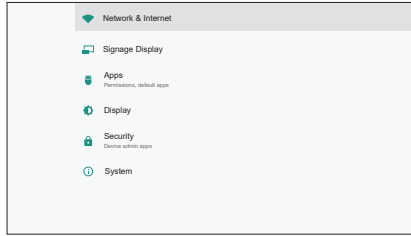

Adjustment Item	Problem / Option			
Signage Display	System tools	Touch lock password	Enable	Click the checkbox to Enable / Disable.
			Modify Password	Change the password.
			Reset Password	Reset the password to default value.
		Display Mode lock password	Enable	Click the checkbox to Enable / Disable.
			Modify Password	Change the password.
			Reset Password	Reset the password to default value.
		5 Hotkeys-Main Menu	Enable	Click the checkbox to Enable / Disable.
			Modify 5-hotkeys	Change the password.
			Reset 5-hotkeys	Reset the password to default value.
		5 Hotkeys-Source Menu	Enable	Click the checkbox to Enable / Disable.
			Modify 5-hotkeys	Change the password.
			Reset 5-hotkeys	Reset the password to default value.
		5 Hotkeys-Switch PD/ Home Display Mode	Enable	Click the checkbox to Enable / Disable.
			Modify 5-hotkeys	Change the password.
			Reset 5-hotkeys	Reset the password to default value.
		Swipe up	Swipe up enable	Enable / Disable up slide to turn on source menu.

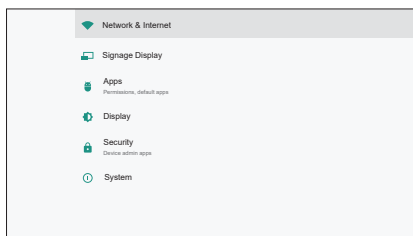

Adjustment Item	Problem / Option		
Signage Display	System updates	Local update	Firmware update.
Apps	Display applications information.		
Display	Set the font size.		
Security	Display credential storage information.		
System	Keyboard & inputs	Set keyboard and input method.	
	Developer options	When you change the system settings, a problem like system instability may occur. In that case, contact your dealer or iiyama service center for assistance.	
	About	Main info in About: System updates / Android version / Kernel version / Build number Automatically search update .zip from USB or SD card. When you select the updated .zip file, the monitor will restart and the update will start.	

**Save:** Save  
**Forget:** Delete

**Discard:** Discard  
**Cancel:** Close without saving

#### ■ Quick Info

Press the Info button and number 77 on the remote control.  
Display the Network and Monitor etc. information.



<Android> \* Android upgrade is not available on this model.

- Settings : Go to settings app.
- Apps : Show all apps. (Browser / Chromium / File Manager / Media Player / PDF player / Settings)
- Network : Set Ethernet.
- Storage : Display current Android storage information.

● Preparation for using Media Player and PDF Player

In order to use the Media Player you need to save the file in an specific file folder on your USB or SD card.

1. Create a folder called "signage" on your USB or SD card, create a subfolders (video / photo / music / pdf) in that folder.
  - videos in /signage/video/
  - photos in /signage/photo/
  - music in /signage/music/
  - pdfs in /signage/pdf/
2. Save the Video / Photo / Music / PDF files in the subfolders of your USB or SD card.
3. Insert your USB or SD card into an USB port or SD card slot of the monitor.
4. When using internal storage, save the necessary files of your USB or SD card to an appropriate signage folder and subfolders in the internal storage of the monitor.
  - videos in /signage/video/
  - photos in /signage/photo/
  - music in /signage/music/
  - pdfs in /signage/pdf/

**NOTE** sure you select the right folder.

If you save the file in the wrong folder, you may not find it.

■ Slide bar

- **Open:** Open folder (USB/SD card)
- **Delete:** Delete files.
- **Copy:** Copy files.
- **Move:** Move files.
- **Select:** Select files.
- **Select All:** Select all files.

■ Supported file system:

FAT32

■ Supported file format:

- Music: MP3, WMA, WMA pro, M4A, AAC, LPCM
- Video: AVI, MP4, 3GPP, MKV, ASF, VRO VOB, PS, TS
- Photo: JPEG, BMP, PNG, GIF

## [Media Player]

- Play: Select playlist to play
- Compose: Edit playlist
- Settings: Setting play properties





### ● Compose

1. Select "Compose" on the page. First you select one playlist to play between FILE1 and FILE7.
2. Select the file and select edit or delete.
3. Save the edited file.
  - videos in /signage/video/
  - photos in /signage/photo/
  - music in /signage/music/
4. When you create photo list you will be asked if you want to play back ground music during slideshow playback. Set as required.

#### ■ Slide bar

- **Source:** Select storage (USB/SD card)
- **Playlist:** Show playlist (Internal)
- **Select all:** Select all storage files.
- **Delete all:** Delete playlist files.
- **Add/Remove:** Update playlist from the source.
- **Sort:** Sort playlist.
- **Save/Abort:** Save or abort playlist.
- **Back:** Return.





#### ■ Remote control

-  **Option key:** Display sidebar
-  **Play key:** Play media file
-  **Pause key:** Pause
-  **Info key:** Show media info
-  **OK key:** Select / deselect file

### ● Play

Select "Play" on the page. First you select one playlist to play between FILE1 and FILE7.

#### ■ Media Hotkey

-  **Play:** To play the media file.
-  **Pause:** To pause the media file.
-  **Fast forward:** To skip forward 20 seconds.
-  **Rewind:** To skip backward 20 seconds.
-  **Stop:** To stop the media file. If it is a gif file, it will pause.

- **Settings**

Select "Settings" on the page.

- **Repeat mode:** Play mode.

Repeat once: All files are repeated once.

Repeat all: All files in the same folder play repeatedly.

- **Slideshow Effect:** Photo slideshow effect.

Right to left: Change from right to left sliding.

Fold: Change by rotating horizontally in the center.

Corner: Change by enlarging from the upper left corner to the lower right corner.

None: Normal

- **Effect Duration:** Photo effect duration. 5s/10s/15s/20s

## [Browser]

- **Settings**

Select "Settings" on the page.

- Set frequently used URL.

1. Select 1 - 7.

2. Enter URL and press OK.

3. Press 'Option' to display the slide bar.

**Import:** Import URL list file

**Export:** Export URL list file

**Delete all:** Delete all URL record

**Back:** Slide bar will be closed

## [PDF Player]





### ● Compose

1. Select "Compose" on the page. First you select one playlist to play between FILE1 and FILE7.
2. Select the file and select edit or delete.
3. Save the edited file.  
-pdfs in /signage/pdf/

#### ■ Slide bar

- **Source:** Select storage (USB/SD card)
- **Playlist:** Show playlist (Internal)
- **Select all:** Select all storage files.
- **Delete all:** Delete playlist files.
- **Add/Remove:** Update playlist from source.
- **Sort:** Sort playlist.
- **Save/Abort:** Save or abort playlist.
- **Back:** Return.





#### ■ Remote control

-  **Option key:** Display sidebar
-  **Play key:** Play media file
-  **Info key:** Show media info
-  **OK key:** Select / deselect file

### ● Play

Select "Play" on the page. First you select one playlist to play between FILE1 and FILE7.







#### ■ Media Hotkey

-  **Play:** To play the PDF file.
-  **Pause:** To pause the PDF file.
-  **Fast forward:** Go to the next page, if the page is end of the file, it will go to next file.
-  **Rewind:** Back to previous page, if the page is first of the file, it will back to previous file.
-  **Stop:** Return to first page of file.

#### ■ Color Hotkey

- **Blue key:** Zoom in (+10%)
- **Yellow key:** Zoom out (-10%)
-  **OK key:** Restore zoom

#### ■ Arrow key

-  /  /  /  : Adjust page (When the page has zoomed in/out)
-  : Previous page (When the page has not zoomed in/out)
-  : Next page (When the page has not zoomed in/out)

### ● Settings

Select "Settings" on the page.

- **Repeat mode:** Play mode.  
Repeat once: All files are repeated once.  
Repeat all: All files in the same folder play repeatedly.
- **Effect Duration:** PDF effect duration. 5s/10s/15s/20s

**[Chromium]**

Connect the network, and browse the web.

**[Cloud Storage]**

Connect the network, and the Cloud Drive.

**[EShare Pro]**

EShare is a multiscreen interaction application which makes the user experience natural and enjoyable for home entertainment, business presentation, and educational training.

**[File Manager]**

Browse the files stored in the internal storage, USB and SD card.  
Recognize remaining memory capacity.

**[iiyama OTA]**

Check and update to latest FirmWare version.

**[iMirror]**

This is software which can display an image of a smartphone on the monitor.

**[Whiteboard]**

Can write the characters, lines and pictures also can insert an image or file.

## STANDBY FEATURE

This product features the standby function. When activated, it automatically reduces unnecessary power consumption of the monitor when your computer is not in use.

There is a standby step the monitor takes as described below. The standby function, including any timer settings is configured by the operating system. Check your operating system manual for information on how this can be configured.

### ■ Standby Mode

When the video signal from the computer is off, the monitor enters into Standby Mode which reduces the power consumption to less than 1.5W\*. The screen becomes dark, and the power indicator turns to red. From Standby Mode, the image reappears in several seconds when either the keyboard or the mouse are touched again.

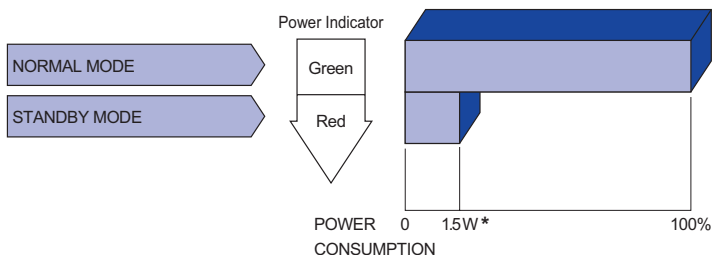

\* When the USB devices are not connected.

# TROUBLE SHOOTING

If the monitor fails to operate correctly, please follow the steps below for a possible solution.

1. Perform the adjustments described in OPERATING THE MONITOR, depending on the problem you have. If the monitor does not get a picture, skip to 2.
2. Consult the following items if you cannot find an appropriate adjustment item in OPERATING THE MONITOR or if the problem persists.
3. If you are experiencing a problem which is not described below or you cannot correct the problem, discontinue using the monitor and contact your dealer or iiyama service center for further assistance.

Problem	Check
① The picture does not appear. (Power indicator does not light up.)  (Power indicator is green.)  (Power indicator is red.)	<input type="checkbox"/> The Power Cable is firmly seated in the socket. <input type="checkbox"/> The Power Switch is turned ON. <input type="checkbox"/> The AC socket is live. Please check with another piece of equipment. <input type="checkbox"/> If the blank screen saver is in active mode, touch the keyboard or the mouse. <input type="checkbox"/> Increase the Contrast and/or Brightness. <input type="checkbox"/> The computer is ON. <input type="checkbox"/> The Signal Cable is properly connected. <input type="checkbox"/> The signal timing of the computer is within the specification of the monitor. <input type="checkbox"/> If the monitor is in standby mode, touch the keyboard or the mouse. <input type="checkbox"/> The computer is ON. <input type="checkbox"/> The Signal Cable is properly connected. <input type="checkbox"/> The signal timing of the computer is within the specification of the monitor.
② The screen is not synchronized.	<input type="checkbox"/> The Signal Cable is properly connected. <input type="checkbox"/> The signal timing of the computer is within the specification of the monitor.
③ The screen position is not in the center.	<input type="checkbox"/> The signal timing of the computer is within the specification of the monitor.
④ The screen is too bright or too dark.	<input type="checkbox"/> The video output level of the computer is within the specification of the monitor.
⑤ The screen is shaking.	<input type="checkbox"/> The power voltage is within the specification of the monitor. <input type="checkbox"/> The signal timing of the computer is within the specification of the monitor.
⑥ No sound.	<input type="checkbox"/> The audio equipment (computer etc.) is ON. <input type="checkbox"/> The Audio Cable is properly connected. <input type="checkbox"/> The Volume is turned up. <input type="checkbox"/> The Mute is OFF. <input type="checkbox"/> The audio output level of the audio equipment is within the specification of the monitor.
⑦ The sound is too loud or too quiet.	<input type="checkbox"/> The audio output level of the audio equipment is within the specification of the monitor.
⑧ A strange noise is heard.	<input type="checkbox"/> The Audio Cable is properly connected.

# RECYCLING INFORMATION

For better environment protection please don't dispose your monitor.  
Please visit our web site: [www.iiyama.com](http://www.iiyama.com) for monitor recycling.



# APPENDIX

Design and specifications are subject to change without prior notice.

## SPECIFICATIONS : ProLite T4362AS

Touch Screen	Technology	Projected capacitive 20pt touch
	Light transmission	84%
	Hardness	6H
	Thickness	3.425mm
	Communication system	USB
	Response time	<25mm
Size Category		43"
LCD Panel	Panel technology	ADS
	Size	Diagonal: 42.5" (108cm)
	Pixel pitch	0.0817mm H × 0.003(RGB) × 0.2451mm V
	Brightness	500cd/m <sup>2</sup> (Typical: without glass), 260cd/m <sup>2</sup> (Default / Energy Saving)
	Contrast ratio	1200 : 1 (Typical)
	Viewable angle	Horizontal : 178 degrees, Vertical: 178 degrees (Typical)
	Response time	8ms (Typical, Gray to Gray)
Display Colors		Approx.1.07 G
Sync Frequency		Horizontal: 30.0-135.0kHz, Vertical: 50-75Hz
Native Resolution		3840 × 2160, 8.3 MegaPixels
Support Max. Resolution		3840 × 2160 60Hz
Input Connector		HDMI × 3
LAN		RJ45
Serial Port		RS-232C In/Out ø 2.5mm sub-mini jack
Input Video Signal		Digital: HDMI
IR Extender Connector		IR In/Out
USB Connector		USB2.0(DC5V, 500mA) USB Media Player × 1, Service port × 1
Micro SD card slot		Micro SD
Speakers		Internal: 10W×2 (Stereo speakers)
Maximum Screen Size		941.184mm W × 529.416mm H / 37.1" W × 20.8" H
Power Source		100-240VAC, 50-60Hz, 1.7A
Power Consumption*		75W typical, Standby mode: 1.5W maximum, Off mode: 0.3W maximum
Dimensions / Net Weight		990.0 × 578.0 × 70.0mm / 39.0 × 22.8 × 2.8" (W×H×D) 10.7kg / 23.6lbs
Environmental Considerations		Operating: Temperature 0 to 40°C / 32 to 104°F Humidity 20 to 80% (No condensation) Storage: Temperature -20 to 60°C / 4 to 140°F Humidity 5 to 95% (No condensation)
Approvals		CE, UKCA, EAC, TÜV-Bauart

**NOTE** \* When the USB devices are not connected.

## SPECIFICATIONS : ProLite T5562AS

Touch Screen	Technology	Projected capacitive 20pt touch
	Light transmission	80%
	Hardness	6H
	Thickness	2.5±0.35mm
	Communication system	USB
	Response time	<25ms
Size Category		55"
LCD Panel	Panel technology	VA
	Size	Diagonal: 54.6" (138.8cm)
	Pixel pitch	0.315mm H × 0.315mm V
	Brightness	500cd/m <sup>2</sup> (Typical: without glass), 240cd/m <sup>2</sup> (Default / Energy Saving)
	Contrast ratio	5000 : 1 (Typical)
	Viewable angle	Horizontal : 178 degrees, Vertical: 178 degrees (Typical)
	Response time	8ms (Typical, Gray to Gray)
Display Colors		Approx.1.07 G
Sync Frequency		Horizontal: 30.0-135.0kHz, Vertical: 50-75Hz
Native Resolution		3840 × 2160, 8.3 MegaPixels
Support Max. Resolution		3840 × 2160 60Hz
Input Connector		HDMI × 3
LAN		RJ45
Serial Port		RS-232C In/Out ø 2.5mm sub-mini jack
Input Video Signal		Digital: HDMI
IR Extender Connector		IR In/Out
USB Connector		USB2.0(DC5V, 500mA) USB Media Player × 1, Service port × 1
Micro SD card slot		Micro SD
Speakers		Internal: 10W×2 (Stereo speakers)
Maximum Screen Size		1209.6mm W × 680.4mm H / 47.6" W × 26.8" H
Power Source		100-240VAC, 50-60Hz, 2.3A
Power Consumption*		150W typical, Standby mode: 1.5W maximum, Off mode: 0.3W maximum
Dimensions / Net Weight		1264.5 × 735.0 × 66.0mm / 49.8 × 28.9 × 2.6" (W×H×D) 16.7kg / 36.8lbs
Environmental Considerations		Operating: Temperature 0 to 40°C / 32 to 104°F Humidity 20 to 80% (No condensation) Storage: Temperature -20 to 60°C / 4 to 140°F Humidity 5 to 95% (No condensation)
Approvals		CE, UKCA, EAC, TÜV-Bauart

**NOTE** \* When the USB devices are not connected.

## SPECIFICATIONS : ProLite T6562AS

Touch Screen	Technology	Projected capacitive 20pt touch
	Light transmission	80%
	Hardness	6H
	Thickness	2.5±0.35mm
	Communication system	USB
	Response time	<25mm
Size Category		65"
LCD Panel	Panel technology	ADS
	Size	Diagonal: 64.5" (164cm)
	Pixel pitch	0.124mm H × 0.003(RGB) × 0.372mm V
	Brightness	500cd/m <sup>2</sup> (Typical: without glass), 245cd/m <sup>2</sup> (Default / Energy Saving)
	Contrast ratio	1200 : 1 (Typical)
	Viewable angle	Horizontal : 178 degrees, Vertical: 178 degrees (Typical)
	Response time	8ms (Typical, Gray to Gray)
Display Colors		Approx.1.07 G
Sync Frequency		Horizontal: 30.0-135.0kHz, Vertical: 50-75Hz
Native Resolution		3840 × 2160, 8.3 MegaPixels
Support Max. Resolution		3840 × 2160 60Hz
Input Connector		HDMI × 3
LAN		RJ45
Serial Port		RS-232C In/Out ø 2.5mm sub-mini jack
Input Video Signal		Digital: HDMI
IR Extender Connector		IR In/Out
USB Connector		USB2.0(DC5V, 500mA) USB Media Player × 1, Service port × 1
Micro SD card slot		Micro SD
Speakers		Internal: 10W×2 (Stereo speakers)
Maximum Screen Size		1428.48mm W × 803.52mm H / 56.2" W × 31.6" H
Power Source		100-240VAC, 50-60Hz, 2.7A
Power Consumption*		165W typical, Standby mode: 1.5W maximum, Off mode: 0.3W maximum
Dimensions / Net Weight		1485.0 × 860.0 × 71.0mm / 58.5 × 33.9 × 2.8" (W×H×D) 27.8kg / 61.2lbs
Environmental Considerations		Operating: Temperature 0 to 40°C / 32 to 104°F Humidity 20 to 80% (No condensation) Storage: Temperature -20 to 60°C / 4 to 140°F Humidity 5 to 95% (No condensation)
Approvals		CE, UKCA, EAC, TÜV-Bauart

### NOTE

\* When the USB devices are not connected.

**DIMENSIONS : ProLite T4362AS**

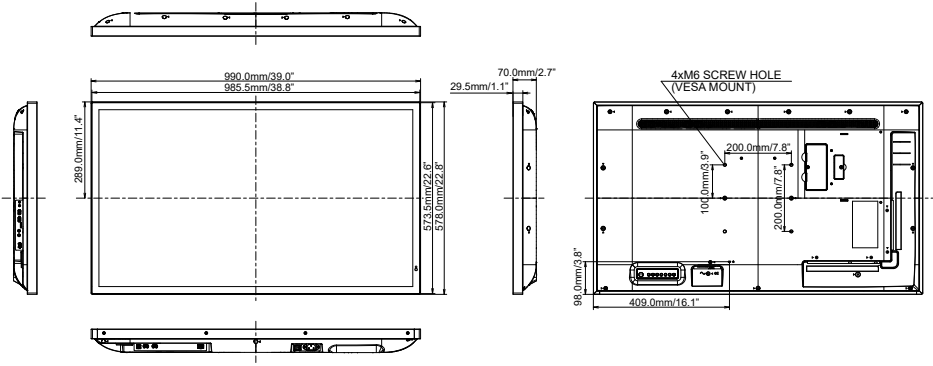

**DIMENSIONS : ProLite T5562AS**

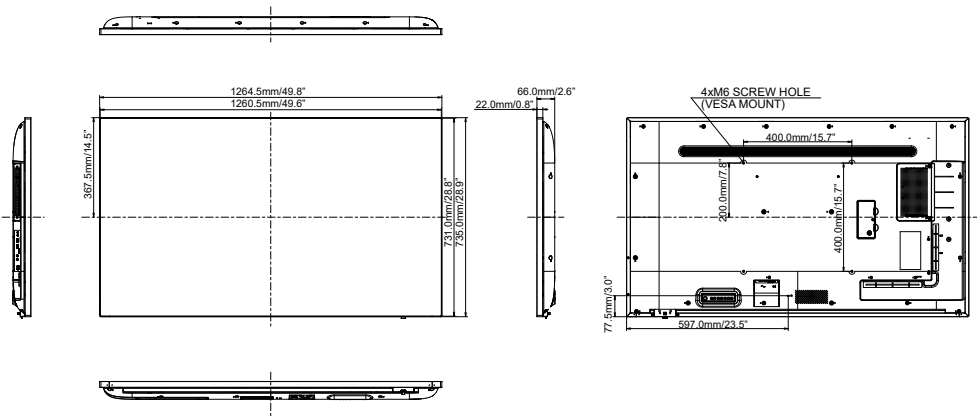

## DIMENSIONS : ProLite T6562AS

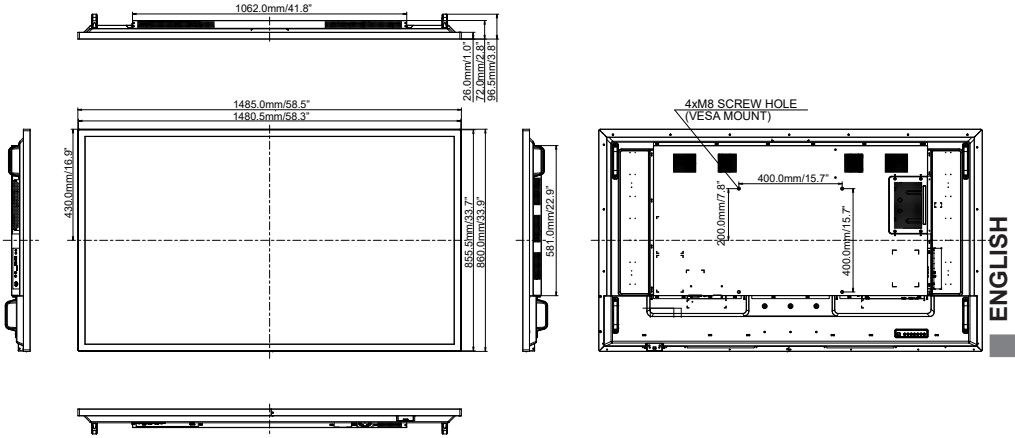

ENGLISH

## COMPLIANT TIMING

Timing		fH (kHz)	fV (Hz)	Dot clock (MHz)	HDMI1	HDMI2	HDMI3
VESA	VGA 640x480	31.5	60.0	25.175	○	○	○
	SVGA 800x600	37.9	60.0	40.000	○	○	○
	XGA 1024x768	48.4	60.0	65.000	○	○	○
	WXGA 1280x768	47.8	60.0	79.500	○	○	○
	QVGA 1280x960	60.0	60.0	108.000	○	○	○
	SXGA 1280x1024	64.0	60.0	108.000	○	○	○
	HD FWXGA 1366x768	47.7	60.0	85.500	○	○	○
	CVT 1400x900	55.9	60.0	106.500	○	○	○
	WSXGA 1680x1050	65.3	60.0	146.250	○	○	○
	FHD 1920x1080	67.5	60.0	148.500	○	○	○
4K 3840x2160		67.5	30.0	297.000	○	○	○
		135.0	60.0	594.000	○	○	○
IBM	720x400	31.5	70.0	28.320	○	○	○
SD	NTSC-M	15.7	60.0	13.500			
	NTSC-J	15.7	60.0	13.500			
	PAL-BDGH	15.7	60.0	13.500			
	480i	60Hz	15.7	60.0	13.500	○	○
	576i	50Hz	15.6	50.0	13.500	○	○
	480p	60Hz	31.5	60.0	27.000	○	○
	576p	50Hz	31.3	50.0	27.000	○	○
HD	720p	50Hz	37.5	50.0	74.250	○	○
		60Hz	45.0	60.0	74.250	○	○
	1080i	50Hz	28.1	50.0	74.250	○	○
		60Hz	33.8	60.0	74.250	○	○
	1080p	50Hz	56.3	50.0	148.500	○	○
		60Hz	67.5	60.0	148.500	○	○

\* ○ means supported the timing.